

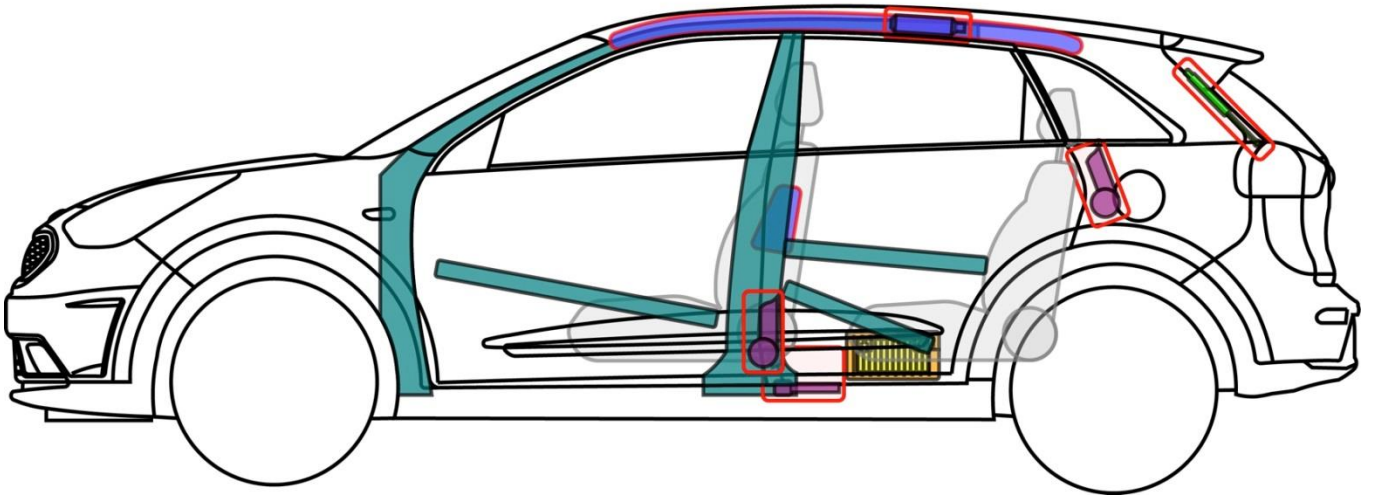

Niro (DE HEV)

ab MY 2018-
12V in HV Batterie

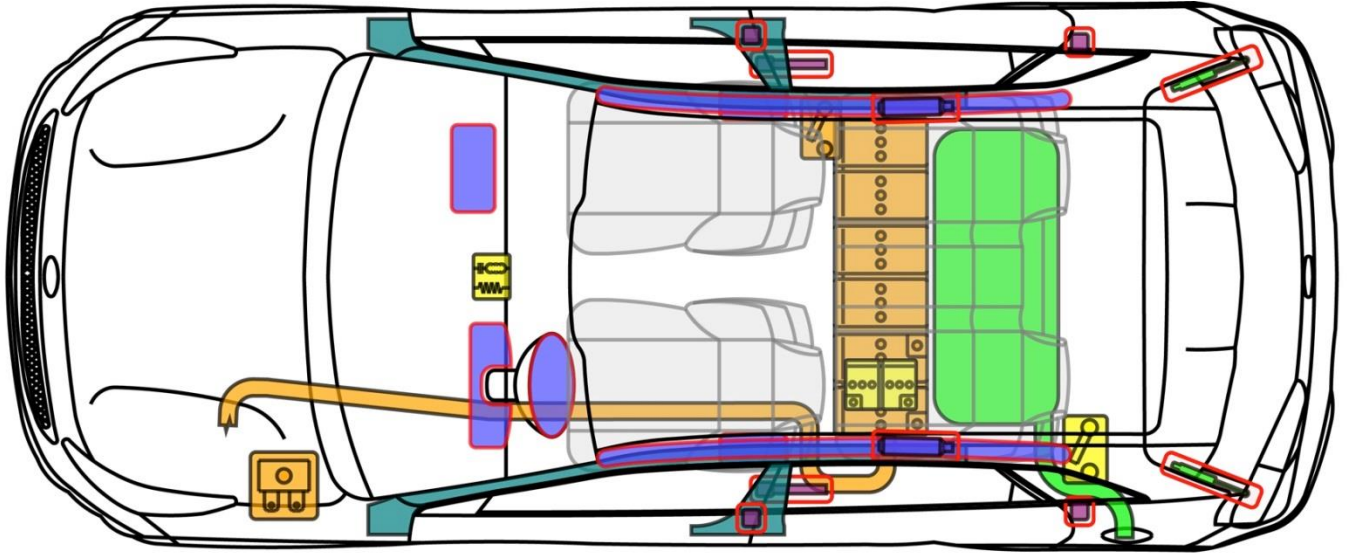

Legende

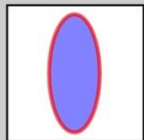

Airbag

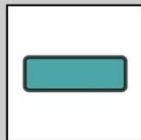

Karosserie-
verstärkung



Steuergerät

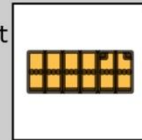

Hochvolt-
batterie

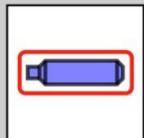

Gas-
generator

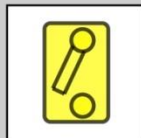

12 V
Batterie
Trennstelle

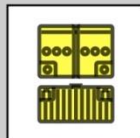

12 V
Batterie

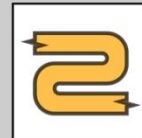

Hochvolt-
leitung/
-komponente

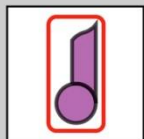

Gurt-
straffer

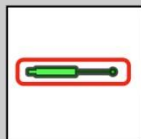

Gasdruck-
dämpfer

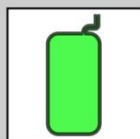

Kraftstoff-
tank



HV-
Trennstelle

Niro