

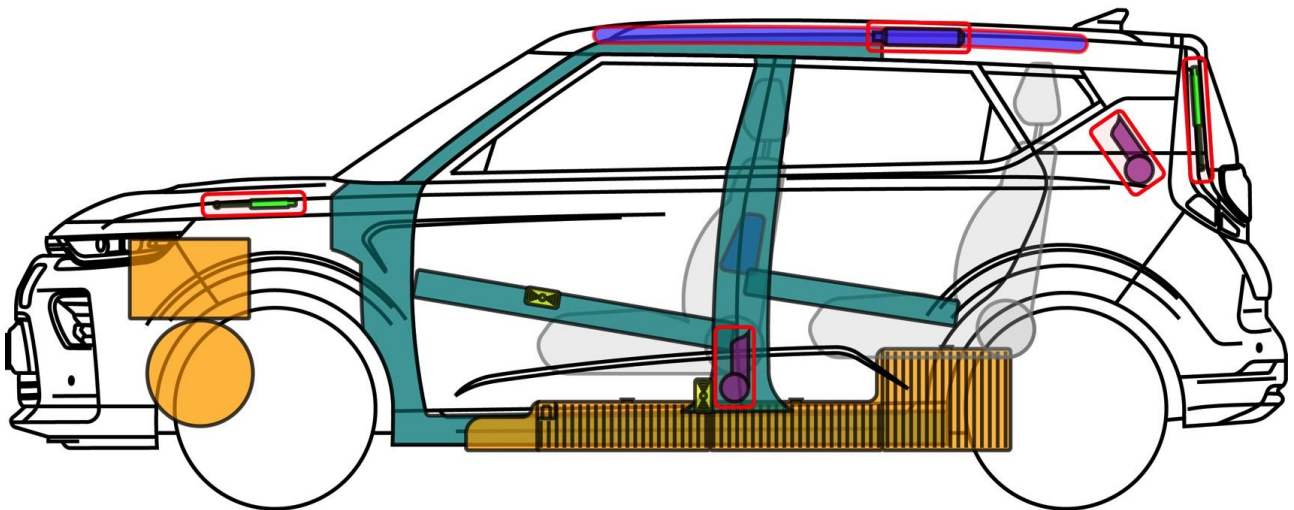

Soul EV (SK3)

ab 2019

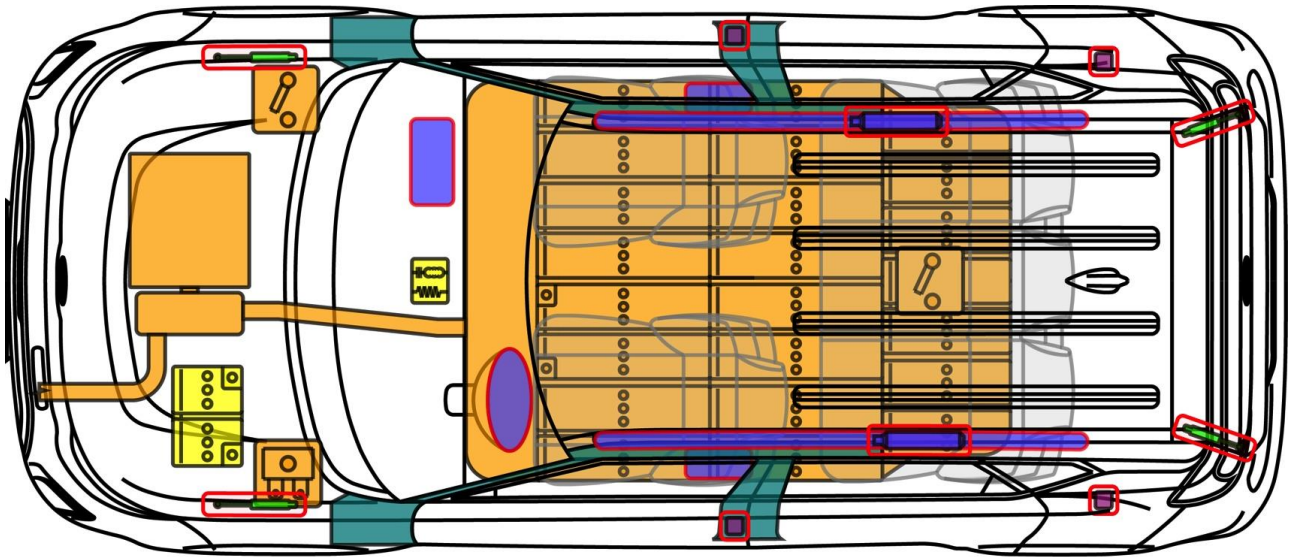

Legende

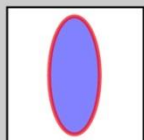

Airbag

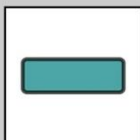

Karosserie-
verstärkung



Steuergerät



Hochvolt-
batterie

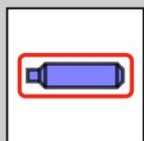

Gas-
generator



Fußgänger-
Schutz-
system

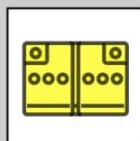

12 V
Batterie

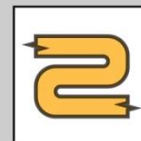

Hochvolt-
leitung/
-komponente

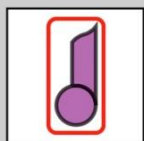

Gurt-
straffer

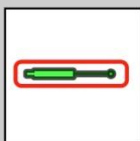

Gasdruck-
dämpfer

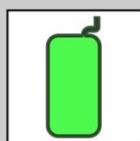

Kraftstoff-
tank



HV-
Trennstelle

Soul EV