

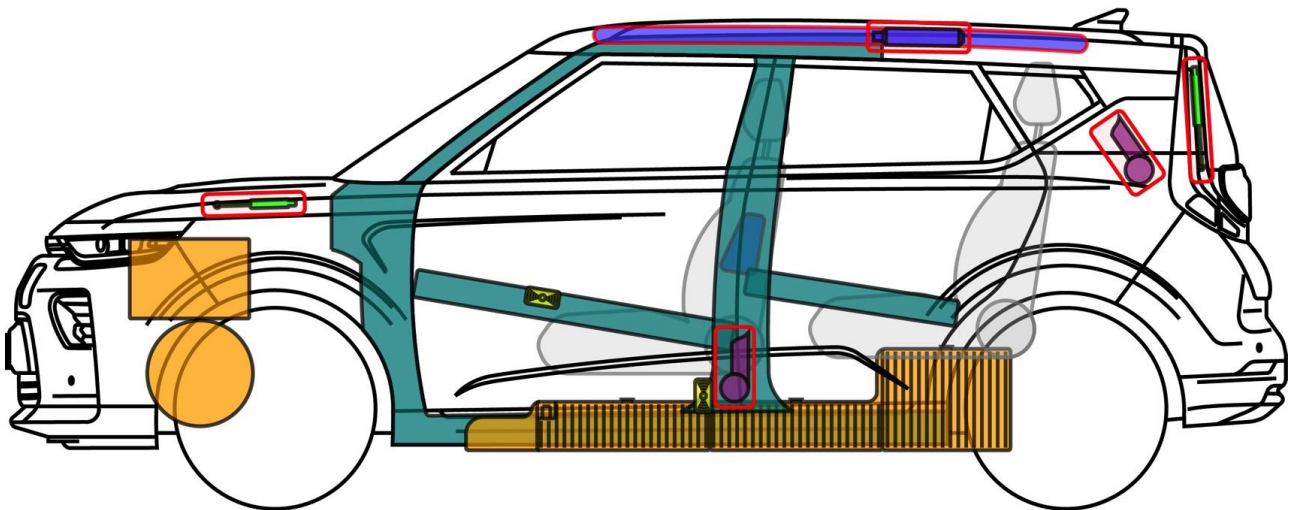

# Soul EV (SK3)

ab 2019

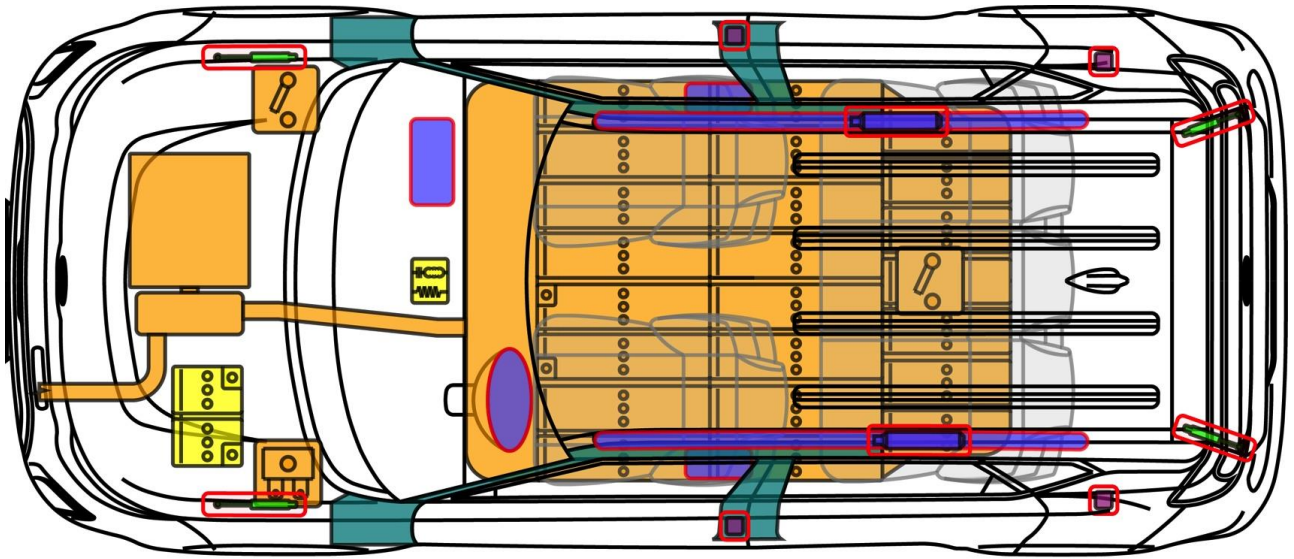

## Legende

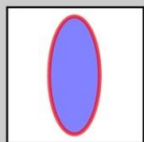

Airbag

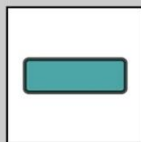

Karosserie-  
verstärkung



Steuergerät

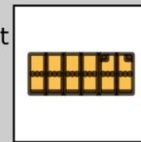

Hochvolt-  
batterie

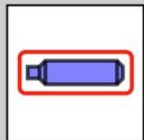

Gas-  
generator



Fußgänger-  
Schutz-  
system

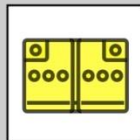

12 V  
Batterie

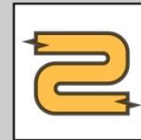

Hochvolt-  
leitung/  
-komponente

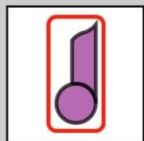

Gurt-  
straffer

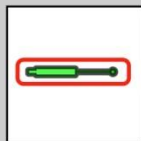

Gasdruck-  
dämpfer

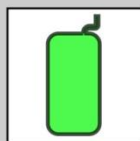

Kraftstoff-  
tank



HV-  
Trennstelle

Soul EV