

## The Power to Surprise

Kia is the newest and most exciting force of change in the automotive world and we are ready to change the way you feel and think about driving. More than just a promise, we are committed to making driving a true pleasure for customers across the globe. With youthful and dynamic styling and the latest in advanced technologies, Kia cars are turning heads the world over with the power to surprise. From the Picanto to the Telluride, Kia offers a full lineup of sedans, SUVs and MPVs that are not only practical and stylish but downright exhilarating to drive. Keep your eyes on Kia because our best has yet to come.

### About Kia Motors Corporation

Kia Motors (www.kia.com) is a maker of world-class quality vehicles for the young-at-heart. Founded in 1944, Kia today sells around 3 million vehicles a year in over 190 countries, with 52,000 employees worldwide, annual revenues of over KRW 58 trillion (about US\$50 billion) and manufacturing facilities in six countries. Kia is spearheading the transition to electric vehicles and pursuing mobility services to help tackle urban challenges around the world. The company's brand slogan - "The Power to Surprise" - represents Kia's global commitment to surprise the world with exciting, inspiring experiences that go beyond expectations.

For more information, please visit the Kia Motors Global Media Center at [www.kianewscenter.com](http://www.kianewscenter.com).



<https://www.facebook.com/KiaBrunei>



<https://twitter.com/KiaBrunei>



<https://www.instagram.com/kiabrunei>



<https://www.youtube.com/user/KiaBUZZ>



GRAND MOTORS SDN BHD

Main Branch :

Lot 33, Tapak Perindustrian,  
Beribi II Km 7, Jalan Gadong  
Bandar Seri Begawan BE 1118  
Brunei Darussalam  
Tel : 2613888 ext 241  
Fax : 2453103

KB Branch :

Unit 25 & 26, Grd Flr, Blk D,  
Mastercon Building Jln Sungai  
Pandan, Lot 7536, Kg Pandan  
Kuala Belait KA1931  
Brunei Darussalam  
Tel : 3334244 / 3334250  
Fax : 3334250

[www.kia.com](http://www.kia.com)



The Power to Surprise



*Carnival*



THE FAMILY WILL  
LOVE IT TOO

Is it a sculpted, luxurious object of desire? A solid, practical family vehicle?  
A showcase for the latest in simple, yet thorough, driver assistance technology?  
Or a remarkably roomy and relaxing space for up to eleven people?  
The new Kia Carnival is all of these things, and more.



With an infinitely adaptable interior and easy access from every angle, the Carnival puts you in total control. It can take a large group of family or friends as far as the roads can reach, with ample space to accommodate the gear for adventurers, the tools of artisans or furniture to bring home from the store.



From the futuristic headlamps embedded into the tiger-nose grille, to the broad, dramatic stripe of the rear tail lamps, fresh details establish a luxurious new design vernacular among people movers. Sleek body lines serve an aerodynamic purpose, while the expansive windows and dual sunroof complement the cabin's feeling of openness.



Graceful, sophisticated lines bring a touch of charm to any driveway. But everything about the Carnival is engineered with flexibility in mind. Power sliding rear doors can be activated with the touch of a button and, if your arms are full, the rear hatch automatically closes and locks just by walking away with the remote in your possession.

A blue Ford Carnival minivan is parked in a city street at dusk. The car is positioned in a yellow-painted parking space. In the background, there is a modern building with large glass windows and a covered walkway. A white SUV is driving past on the right side of the frame. The scene is lit with warm, low-angle light, creating long shadows and a calm atmosphere.

## A BRIGHT SPOT IN THE HEART OF THE CITY

Venture in and out of cities in a spacious bubble of calm. Sliding doors make for quick entries and exits, and a puddle lamp shows you where you're stepping after dark. The same technological advances that keep the interior so quiet on the highway also help shut out city noises to create a calming oasis of comfort.



## A COMPANION FOR PICTURESQUE MOMENTS

Travelling with the whole family, and maybe a few friends too, is one of those life events that makes for lasting memories. The Carnival is hard to beat when it comes to intimate adventures, offering comfortable seating, plenty of space, lots of light, and the connectivity to keep you in touch with the rest of the world.



CONTROL IS  
THE NAME OF THE GAME

Carnival's upscale and sophisticated interior puts the driver in command by enabling quick choices with minimal distraction through the use of steering wheel controls, or by tapping on the intuitive center-console screen.





**8** Seats

## INDIVIDUAL COMFORT FOR EVERY SINGLE SEAT

With firm, welcoming seats, enviable headroom, and tasteful materials, the Carnival comfortably accommodates every individual occupant. From the ways the doors slide to how the seats can be adjusted and moved, the interior is engineered to make the ride a joy for everyone inside.



**7** Seats



**11** Seats



## SURROUNDED BY SCREENS THAT SAY JUST ENOUGH

Information technology has changed driving forever. But rather than being bombarded by a seemingly infinite amount of data, the Carnival presents everything on a need-to-know basis, filtering out what's not absolutely necessary. The cockpit is designed and engineered to help you focus on the key information while your mind stays on the road and what's around you.

### A. 4.2-inch supervision cluster

The supervision cluster helps you stay focused and informed, with data like remaining distance to empty and fuel consumption, navigation cues, and outside temperature..

### B. 8-inch display audio

View and select audio functions on the 8-inch display audio. Choose audio sources, tune in to radio stations, and adjust audio quality to taste by using convenient controls mounted on the steering wheel. With wireless phone projection, the display of a compatible phone can be viewed on the center touchscreen.

### C. Smartphone wireless charger

Now with up to 15W of electric power, the charging pad in the Wireless Charging Tray bin lets you charge compatible mobile phones wirelessly. The indicator shows orange while charging and turns green when charging is complete.





## WHERE FIRST-CLASS IS IN THE 2<sup>ND</sup> ROW

While the Carnival is notably roomy, the second-row VIP lounge seats, part of a 7-seat layout, may just offer the most indulgent rear-passenger space on the roads today. With soft, high-quality materials and executive-class treatment, the seats also feature heating and ventilation.

### A. VIP lounge seats

Second-row VIP lounge seats give passengers a first-class experience, with exceptional flexibility and simple-to-operate power-adjustment.

An optimal resting posture can be set according to the most ideal body angle.

2<sup>nd</sup> row seat sliding (forward/rearward: 80/320 mm, Lateral: 85 mm)

Leg rest

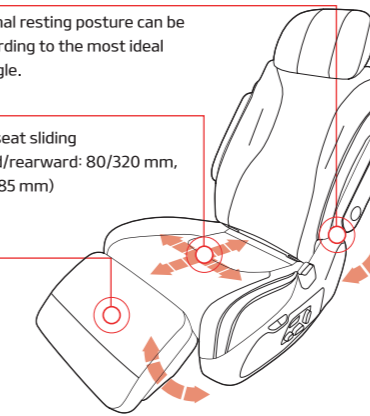

### B. VIP lounge seat switches

Separate buttons adjust recline, seat base, and extendable leg rest. A central button engages relaxation features, while one-touch relaxation and return buttons are located at the top for instant comfort at your fingers.

### C. Relaxation mode

In Relaxation mode, the seatback reclines, the front of the seat base tilts upward, and the leg support lifts and extends. All to help you stretch out and relax.





## THE VERSATILITY TO HANDLE WHATEVER THE FUTURE BRINGS

It's hard to think of a more accommodating and flexible interior than this. Seating options let you fit up to eight people, while some or most seats can be removed to make way for cargo. You can even turn the walk-in (non-reclining) 2<sup>nd</sup> row seat to face backward, so occupants can see each other while they talk, limousine-style.

### Smart power sliding doors



### Power tailgate auto-close

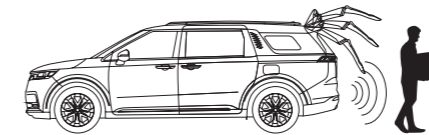

**A. Remote one-touch power doors & liftgate**  
Power sliding rear doors offer easy entry and exit for rear occupants. Along with the power tailgate, all doors can be closed and locked with one smart-key button as you walk away.



### B. Multi-function free mode seat

For the 8-seat model, the 2<sup>nd</sup> row seat can be removed and turned to face the 3<sup>rd</sup> row seat. Or turn and fold the center seat only to create a shared table.

### C. Luggage mode

For 7- or 8-seat models, the 2<sup>nd</sup> row seat can be removed, and a lever lets you fold down the 3<sup>rd</sup> row seat to accommodate cargo.



7.8  
SEATS  
variation



7 seats



8 seats  
(Addition of 2<sup>nd</sup> row center seat)



3<sup>rd</sup> row 6-4  
split seating



2<sup>nd</sup> row center seat  
(Child care mode)

Retractable luggage tray

Smartstream G3.5	Max. Power	33.8	Max. Torque
	ps @ 6,400 rpm		kg-m @ 5,000 rpm
Smartstream D2.2	Max. Power	45.0	Max. Torque
	ps @ 3,800 rpm		kg-m @ 1,750 rpm



**Drive mode selector**  
 The Carnival adapts to the way you want to drive. Push the Drive Mode button beside the shifter to cycle between the fuel-conserving Eco mode, the responsiveness of Normal mode, the exhilaration of Sport mode, or the adaptability of Smart mode, which adjusts according to how your driving style varies over the course of a normal day.

**Paddle shift levers**  
 Access more torque sooner, and choose your own shift points for the 8-speed automatic transmission. You can do it all without taking your hands from the steering wheel thanks to the levers conveniently mounted right at your fingertips.

# LESS VIBRATION, LESS FUEL AND ALL THE POWER YOU NEED

The quieter gasoline and diesel engines of the new Carnival offer significant fuel savings through improved cooling and reduced friction. The 8-speed automatic transmission offers smooth gear changes, with more gear ranges to achieve the perfect balance of economy and power.



#### Safe Exit Assist (SEA) with Power Sliding Door

If you attempt to open the power sliding door as a vehicle approaches from the rear, SEA will keep the door locked and sound a buzzer for one second, so you can check for traffic and try opening it again once it is safe.



#### Rear Cross-Traffic Collision-Avoidance Assist (RCCA)

Rear corner radars detect the presence of cross traffic, from the right or left, in the lane the Carnival is backing into. If a vehicle is detected, and audible and visual warnings go unheeded, emergency braking is applied automatically.



#### Rear View Monitor (RVM)

Rear View Monitor with Parking Guidance gives you a live view of what's behind you. Lines superimposed on the image help you know how much space you have.



#### Parking Distance Warning (PDW)

For utmost confidence and peace of mind when maneuvering into and out of tight spaces, PDW uses ultrasonic sensors mounted on the front and rear bumpers to warn you of any nearby obstacles.

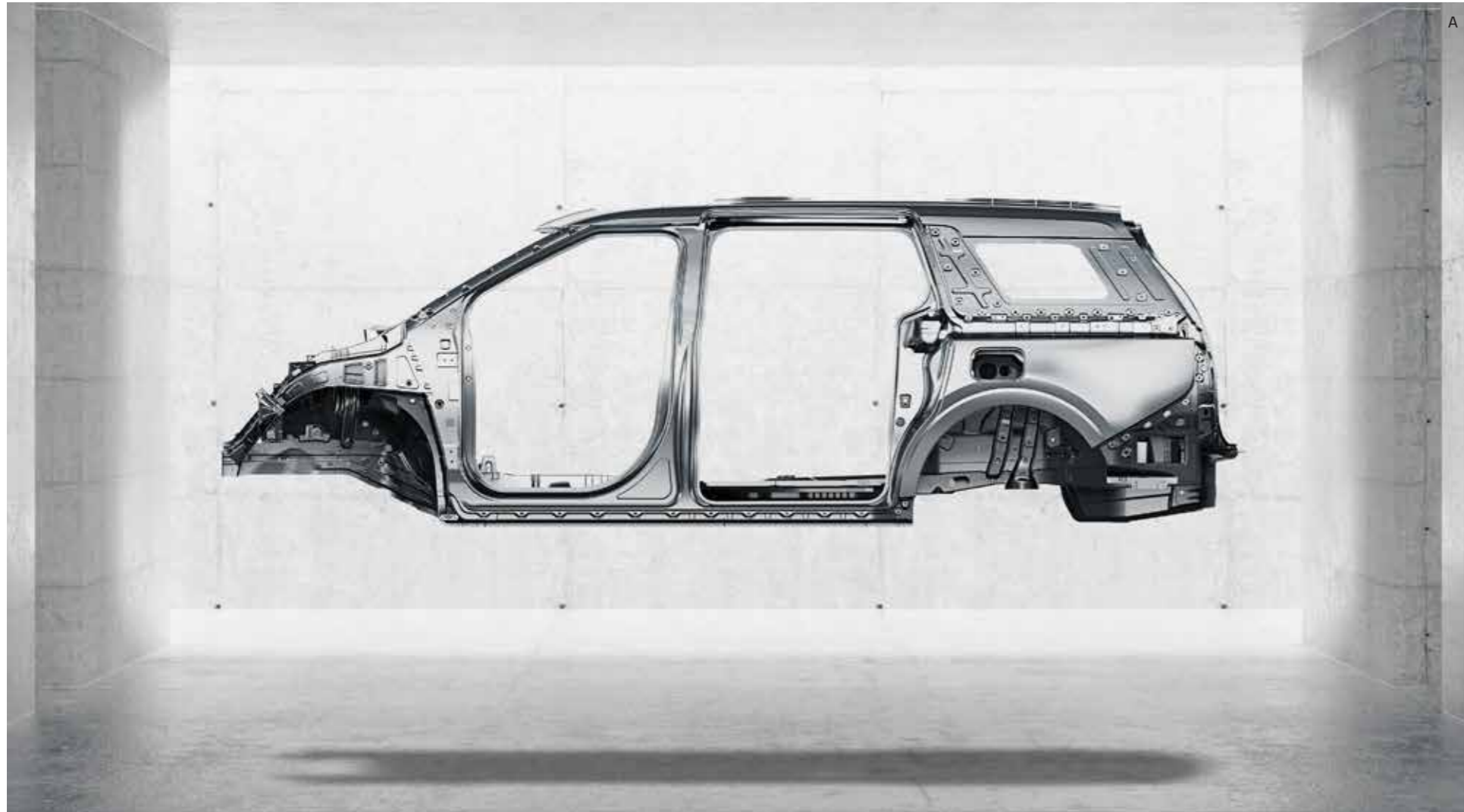

A

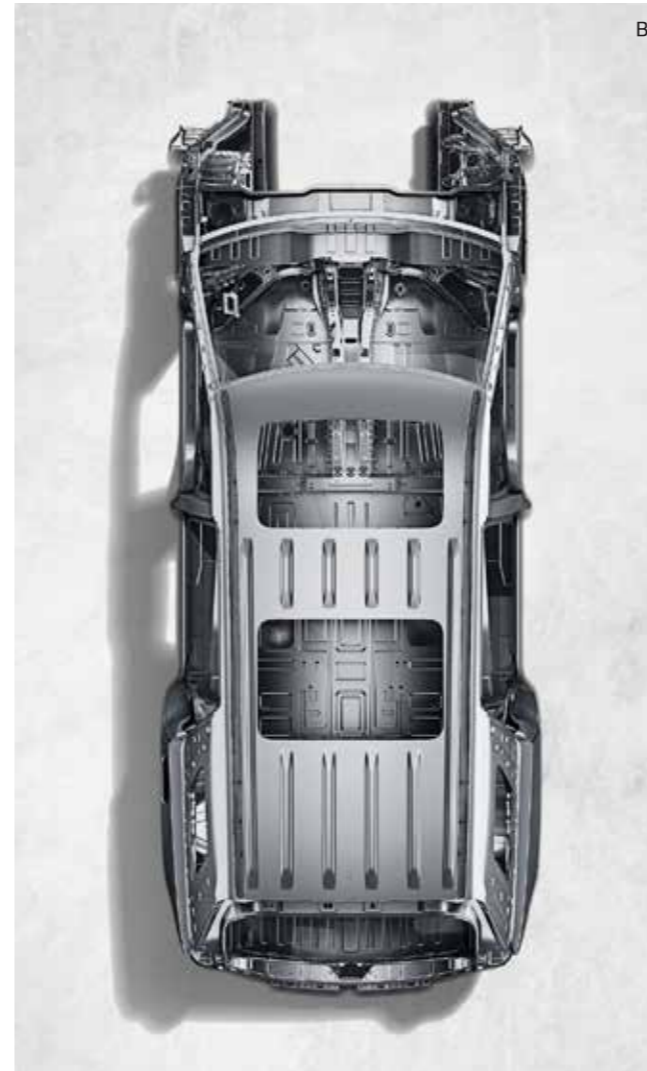

B



C



D



E

## WE'VE THOUGHT OF EVERYTHING TO KEEP YOU READY FOR ANYTHING

Building on an ingeniously integrated new platform, the Carnival uses technological advances, some incremental and others substantial, to better protect you in a collision, and to help you avoid situations that can lead to collisions in the first place. In short, it's always on the lookout for the safety of you and your occupants.

### A. 3<sup>rd</sup> generation platform

The new 3<sup>rd</sup> generation platform standardizes the arrangement of steering, chassis, powertrain, and cabin floor, resulting in a more spacious cabin and improved aerodynamics, handling, stability and collision safety performance. The Carnival benefits from advances made across the entire range of Kia vehicles.

### B. Smarter body and chassis materials

New applications of stronger, more formable steel in crucial areas helps the body and chassis better disperse collision forces to improve occupant protection. Higher torsional rigidity delivers an impressive level of handling responsiveness and ride smoothness.

### C. Airbag system

To help protect occupants and potentially reduce injuries in the event of a collision, seven airbags are offered (driver, driver's knee, front passenger, two front-side, and two side-curtain).

### D. Vehicle Stability Management (VSM)

For enhance safety, VSM continuously monitors road conditions and automatically controls the steering and brakes when the road gets bumpy.

### E. Hill-Start Assist Control (HAC)

When you're at a standstill on an incline, HAC prevents you from rolling backward by gently applying the brakes for up to two seconds while you move your foot from the brake pedal to the accelerator.



SOMETIMES THE BEST DESTINATION  
IS THE JOURNEY ITSELF

Group travel can be an adventure all in itself. The new Carnival applies decades of technological know-how and advancements to improve the ride for everyone, including those who need help getting in and out, kids with short attention spans, and people who just need a chance to unwind and recharge. In a world of all for one, the Carnival is one for all.



## PERSONALIZATION

Your vehicle is your family's home away from home and your pride and joy. So you decide what needs to be on board. The Carnival offers a wide range of features, from elementary to high-tech, and colours and finishes for a comfortable ride in style, so that you feel at home while exploring the world that awaits you.



Standard-type radiator grille



MFR-type LED headlamps



Bluetooth voice recognition



Steering-wheel remote controls



Large center console



Center console tray



3-zone full auto air conditioning



Manual temperature control



Bulb-type rear combination lamps



Hidden rear wiper



Walk-in device



Integrated memory seats (IMS)



1<sup>st</sup> row seatback USB charger & double seatback pockets



Center-console USB charger



Independent rear air-conditioning control



Seat warming and cooling ventilation



Get on/off puddle light



Smart power tailgate



Driver's seat adjustment controls



Dual power sunroof



Center-console power outlet

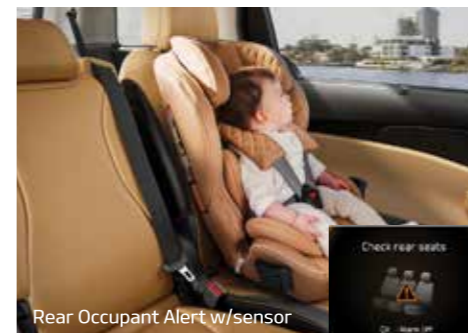

Rear Occupant Alert w/sensor

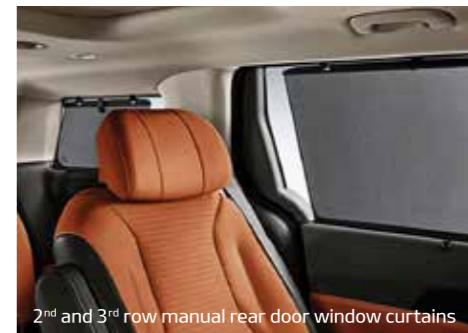

2<sup>nd</sup> and 3<sup>rd</sup> row manual rear door window curtains



Sliding door buttons

## Interior Colours

### Black + Gray



Cloth



Leather

### Black + Martian Brown



Leather

## Wheels



18-inch 235/60R18 Alloy Wheel (A-Type)



19-inch 235/55R19 Alloy Wheel (A-Type)



19-inch 235/55R19 Alloy Wheel (B-Type)

## Exterior Colours



Snow White Pearl (SWP)



Silky Silver (4SS)



Ceramic Silver (C4S)



Aurora Black Pearl (ABP)



Panthera Metal (P2M)



Astra Blue (D2U)



Deep Chroma Blue (D9B)

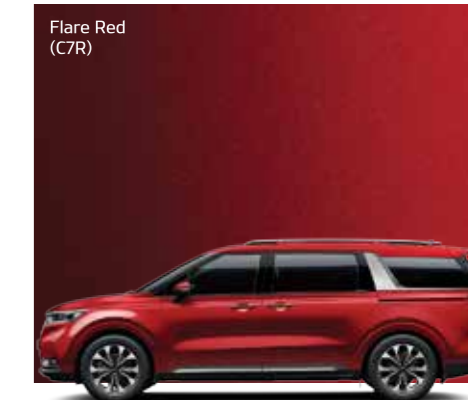

Flare Red (C7R)

## Dimensions (mm)

	7, 8 Seats	* Based on 18-inch wheels	
		7, 8 Seats	
Overall length	5,155	1 <sup>st</sup> row headroom (without sunroof)	1,039
Overall width (without side mirrors)	1,995	2 <sup>nd</sup> row headroom (without sunroof)	1,003
Overall height (with roof rack)	1,775	3 <sup>rd</sup> row headroom (without sunroof)	981
Wheelbase	3,090	1 <sup>st</sup> row shoulder room	1,630
Wheel tread (front)	1,746	2 <sup>nd</sup> row shoulder room	1,606
Wheel tread (rear)	1,746	3 <sup>rd</sup> row shoulder room	1,511
Overhang (front)	935	1 <sup>st</sup> row hip room	1,520
Overhang (rear)	1,130	2 <sup>nd</sup> row hip room	1,686
1 <sup>st</sup> row legroom	1,044	3 <sup>rd</sup> row hip room	1,280
2 <sup>nd</sup> row legroom	1,029		
3 <sup>rd</sup> row legroom	903		

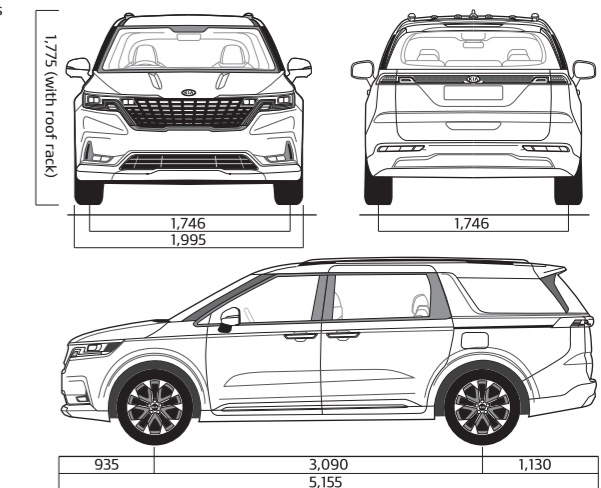

\* All information contained herein was based upon the latest available information at the time of printing. Descriptions are believed to be correct, and Kia Motors Corporation makes every effort to ensure accuracy, however accuracy cannot be guaranteed. From time to time, Kia Motors Corporation may need to update or make changes to the vehicle features and other vehicle information reported in this brochure. Some vehicles shown include optional equipment that may not be available in some regions. All video and camera screens shown are simulated. Kia Motors Corporation, by the publication and dissemination of this material, does not create any warranties, either express or implied, to any Kia products. Contact your local Kia dealer for the most current information.

KIA CARNIVAL

GASOLINE

CRDi

ENGINE

Type		DOHC	DOHC
Fuel Injection System		MPI (Multi Point Injection)	CRDi (Common Rail Direct Injection)
Displacement (cc)		3,470	2,151
Bore x Stroke (mm)		92 x 87	83.0 x 99.4
Compression Ratio		10.6	16.0
Maximum Horsepower	ps/rpm	272 / 6,400	202 / 3,800
Maximum Torque	kg.m/rpm	33.8 / 5,000	45.0 / 1,750~2,750

TRANSMISSION

Type		8-speed Automatic	8-speed Automatic
DriveType		2WD	2WD

KIA CARNIVAL

G (8-STR)

GL (8-STR)

GLS (8-STR)

GLX (7-STR)

STEERING

Type : Motor Driven Power Steering	●	●	●	●
Manual Tilt & Telescopic	●	●	●	●

TYRES AND WHEELS

Tyre Size	235/60R18	235/55R19	235/55R19	235/55R19
Wheel Size	7.0J x 18" Alloy	7.5J x 19" Alloy	7.5J x 19" Alloy	7.5J x 19" Alloy
Spare Wheel & Tyre	Alloy	Alloy	Alloy	Alloy

EXTERIOR

Head Lamps	LED	LED	LED (Dual)	LED (Dual)
Rear Combination Lamps	Bulb	Bulb	LED	LED
Fog Lamp (Front)	-	-	LED	LED
Fog Lamp (Rear)	Bulb	Bulb	Bulb	Bulb
Auto Light Control	●	●	●	●
Daytime Running Light (DRL)	LED	LED	LED	LED
Position Lamp (LED)	●	●	●	●
Outside Mirror	Electric adjustable	●	●	●
	Folding type	Electric	Electric	Electric
	Side Repeater Lamp	●	●	●
Roof Rack	●	●	●	●
Dual Sunroof	-	-	-	●
Rear Spoiler	●	●	●	●
High Mounted Stop Lamp (HMSL)	LED	LED	LED	LED

INTERIOR

Cluster 4.2" TFT-LCD	●	●	●	●
Power Seat	-	-	Driver & Passenger	Driver (Memory) & Passenger
Lumbar Support (Driver) : Power	-	-	2-way	4-way
Wing-out Headrest	-	-	-	●
2nd Relaxion Seat	-	-	-	●
Leg Support (Rear)	-	-	-	●
Heated Seat 3-step Button (Front & Rear)	-	-	-	●
Ventilated Seat (Front & Rear)	-	-	-	●
Walk-in Device (Rear)	●	●	●	●
Upholstery	Cloth	Cloth	Artificial Leather	Pure Leather
Air Conditioning	Front	Manual	Auto (Dual)	Auto (Dual)
	Rear	Manual	Auto (Dual)	Auto (Dual)
Rear Door Curtain	-	●	●	●
Electric Chromic Mirror (ECM)	-	●	●	●

KIA CARNIVAL

G (8-STR)

GL (8-STR)

GLS (8-STR)

GLX (7-STR)

MULTIMEDIA

Infotainment System - 8" TFT LCD Touch Screen	●	●	●	●
12.3" Infotainment & Navigation System	-	-	-	-
Speaker Brand - BOSE Premium Sound System	-	-	●	●
Tweeter + Ext Amplifier + Center (Front) + Surround Sound	-	-	●	●
Audio Remote Control	●	●	●	●
Bluetooth with Voice Recognition	●	●	●	●
Wireless Charging Tray	●	●	●	●
USB Charging Port - Front Tray	●	●	●	●
USB Charging Port - Console Inside	●	●	●	●
USB Charging Port - 1st Row Seat Side	●	●	●	●
USB Charging Port - 3rd Row Seat Side	●	●	●	●

CONVENIENCE

Keyless Entry	●	-	-	-
Smartkey with Button Start	-	●	●	●
Power Sliding Door	-	●	●	●
Power Tailgate	-	●	●	●
Cruise Control	●	●	●	●
Drive Mode Select	●	●	●	●
Paddle Shifter	-	●	●	●
Spot Lamp	-	●	●	●
Passenger Talk & Passenger View Mode	-	-	-	-
Rear Seat Voice Recognition	-	-	-	-

SAFETY

Driver's & Passenger's Airbags	●	●	●	●
Front, Thorax & Pelvis + Curtain Airbags	●	●	●	●
Knee Airbag (Driver)	●	●	●	●
Rear Seat Alert (with Sensor)	-	-	-	●
Electric Parking Brake (EPB) with Autohold	●	●	●	●
Child Anchor	●	●	●	●
Anti-lock Brake System (ABS)	●	●	●	●
Electronic Stability Control (ESC)	●	●	●	●
Hill-start Assist Control (HAC)	●	●	●	●
Parking Assist System	Rear	Front & Rear	Front & Rear	Front & Rear
Rear View Monitor	●	●	-	-
Surround View Monitor	-	-	●	●
Blind-Spot View Monitor (BVM)	-	-	-	-
Immobilizer	●	●	●	●

● : Standard      - : Not Available