

FOREWORD

Dear Customer,

Thank you for selecting your new Kia vehicle.

As a global car manufacturer focused on building high-quality vehicles with exceptional value, Kia is dedicated to providing you with a customer service experience that exceeds your expectations.

This Owner's Manual is valid for all variants of your model, and describes all options, features, and equipment available, along with the maintenance needs. Therefore, this manual may also describe optional equipment not purchased on your vehicle, country specifications, and functions and features not available in your region. Please always keep this manual in the vehicle for your and any subsequent owner's reference.

Authorised Kia Dealerships provide factory-trained technicians, utilized recommended special service tools, and supply genuine Kia replacement parts to help you maintain and service your vehicle during your ownership.

All information contained in this Owner's Manual was accurate at the time of publication. However, as Kia continues to make improvements to its products, the company reserves the right to make changes to this manual or any of its vehicles at any time without notice and without incurring any obligations.

Please drive safely, and enjoy your Kia vehicle!

© 2023 Kia Corporation

All rights reserved. May not be reproduced or translated in whole or in part without the written consent of Kia Corporation.

Printed in Korea

How to use this manual

We want to help you get the greatest possible driving pleasure from your vehicle. Your Owner's Manual can assist you in many ways.

We strongly recommend that you read the entire manual. In order to minimise the chance of death or injury, you must read the WARNING and CAUTION sections in the manual.

Illustrations complement the words in this manual to best explain how to enjoy your vehicle. By reading your manual, you learn about features, important safety information, and driving tips under various road conditions.

The general layout of the manual is provided in the Table of Contents. Use the index when looking for a specific area or subject, it has an alphabetical listing of all information in your manual.

Chapters: This manual has nine chapters plus an index. Each chapter begins with a brief list of contents so you can tell at a glance if that chapter has the information you want.

You will find various WARNINGS, CAUTIONS, and NOTICES in this manual. These WARNINGS were prepared to enhance your personal safety. You should carefully read and follow ALL procedures and recommendations provided in these WARNINGS, CAUTIONS and NOTICES.

WARNING

A WARNING indicates a situation in which harm, serious bodily injury or death could result if the warning is ignored.

CAUTION

A CAUTION indicates a situation in which damage to your vehicle could result if the caution is ignored.

NOTICE

A NOTICE indicates interesting or helpful information is being provided.

Table of Contents

| | |
|---------------------------------------|---|
| Introduction | ① |
| Your vehicle at a glance | ② |
| Safety features of your vehicle | ③ |
| Features of your vehicle | ④ |
| Infotainment system | ⑤ |
| Driving your vehicle | ⑥ |
| Driver assistance system | ⑦ |
| What to do in an emergency | ⑧ |
| Maintenance | ⑨ |
| Specifications & Consumer information | ⑩ |
| Abbreviation | Ⓐ |
| Index | Ⓘ |

Introduction **1**

| | |
|--|-----|
| Fuel requirements | 1-2 |
| Vehicle modifications..... | 1-5 |
| Vehicle break-in process | 1-6 |
| Risk of burns when parking or stopping vehicle | 1-6 |
| Vehicle handling instructions | 1-7 |
| Open Source Software Notice | 1-7 |
| Importer information for United Kingdom | 1-8 |

Introduction

Fuel requirements

Unleaded petrol

For Europe

For the optimal vehicle performance, we recommend you to use unleaded petrol with an octane rating of RON (Research Octane Number) 95/AKI (Anti Knock Index) 91 or higher.

You may use unleaded petrol with an octane rating of RON 91~94/AKI 87~90 but it may result in slight performance reduction of the vehicle. (Do not use methanol blended fuels.)

Except Europe

Your new Kia vehicle is designed to use only unleaded fuel having an Octane Rating of RON (Research Octane Number) 91/AKI (Anti- Knock Index) 87 or higher. (Do not use methanol blended fuels.)

Your new vehicle is designed to obtain maximum performance with unleaded fuel, as well as minimise exhaust emissions and spark plug fouling.

WARNING

- Do not "top off" after the nozzle automatically shuts off when refuelling.
- Always check that the fuel cap is installed securely to prevent fuel spillage in the event of an accident.

CAUTION

Never use leaded fuel. The use of leaded fuel is detrimental to the catalytic converter and will damage the engine con-

trol system's oxygen sensor and affect emission control.

Never add any fuel system cleaning agents to the fuel tank other than what has been specified. (Kia recommends to consult an authorised Kia dealer/service partner for details.)

Petrol containing alcohol and methanol

Gasohol, a mixture of petrol and ethanol (also known as grain alcohol), and petrol or gasohol containing methanol (also known as wood alcohol) are being marketed along with or instead of unleaded petrol.

Do not use gasohol containing more than 10% ethanol, and do not use petrol or gasohol containing any methanol. Either of these fuels may cause drivability problems and damage to the fuel system, engine control system and emission control system.

Discontinue using gasohol of any kind if drivability problems occur.

Vehicle damage or drivability problems may not be covered by the manufacturer's warranty if they result from the use of:

1. Gasohol containing more than 10% ethanol.
2. Petrol or gasohol containing methanol.
3. Leaded fuel or leaded gasohol.

CAUTION

Never use gasohol which contains methanol. Discontinue use of any gasohol product which impairs drivability.

Other fuels

Using fuels such as

- Silicone (Si) contained fuel,
- MMT (Methylcyclopentadienyl Manganese Tricarbonyl), Manganese (Mn) contained fuel,
- Ferrocene (Fe) contained fuel, and
- Other metallic additives contained fuels,

may cause vehicle and engine damage or cause plugging, misfiring, poor acceleration, engine stalling, catalyst melting, abnormal corrosion, life cycle reduction, etc.

Also, the Malfunction Indicator Lamp (MIL) may illuminate.

* NOTICE

Damage to the fuel system or performance problem caused by the use of these fuels may not be covered by your New Vehicle Limited Warranty.

Use of MTBE

Kia recommends avoiding fuels containing MTBE (Methyl Tertiary Butyl Ether) over 15.0% vol. (Oxygen Content 2.7% weight) in your vehicle.

Fuel containing MTBE over 15.0% vol. (Oxygen Content 2.7% weight) may reduce vehicle performance and produce vapour lock or hard starting.

⚠ CAUTION

Your New Vehicle Limited Warranty may not cover damage to the fuel system and any performance problems that are caused by the use of fuels containing methanol or fuels containing MTBE (Methyl Tertiary Butyl Ether) over 15.0% vol. (Oxygen Content 2.7% weight.)

Do not use methanol

Fuels containing methanol (wood alcohol) should not be used in your vehicle. This type of fuel can reduce vehicle performance and damage components of the fuel system, engine control system and emission control system.

Fuel additives

Kia recommends that you use unleaded petrol which has an octane rating of RON (Research Octane Number) 95/AKI (Anti Knock Index) 91 or higher (for Europe) or Octane Rating of RON (Research Octane Number) 91/AKI (Anti-Knock Index) 87 or higher (except Europe).

For customers who do not use good quality petrols including fuel additives regularly, and have problems starting or the engine does not run smoothly, one bottle of additives should be added to the fuel tank when the engine oil is replaced.

Additives are available from a professional workshop along with information on how to use them. Kia recommends to visit an authorised Kia dealer/service partner.

Operation in foreign countries

If you are going to drive your vehicle in another country, be sure to:

- Observe all regulations regarding registration and insurance.
- Determine that acceptable fuel is available.

Diesel engine

Diesel fuel

Diesel engines must be operated only on commercially available diesel fuel that complies with EN 590 or comparable standard. (EN stands for "European Norm"). Do not use marine diesel fuel, heating oils, or non-approved fuel additives, as this will increase wear and cause damage to the engine and fuel system. The use of non-approved fuels and/or fuel additives will result in a limitation of your warranty rights.

Diesel fuel of above cetane 51 is used in your vehicle. If two types of diesel fuels are available, use summer or winter fuel properly according to the following temperature conditions.

- Above -5°C (23°F) ... Summer type diesel fuel.
- Below -5°C (23°F) ... Winter type diesel fuel.

Watch the fuel level in the tank very carefully: If the engine stops through fuel failure, the circuits must be completely purged to restart.

CAUTION

- It is recommended to use the regulated automotive diesel fuel for diesel vehicle equipped with the DPF system. (if equipped)

CAUTION

- If you use diesel fuel including high sulfur (more than 50 ppm sulfur) and unspecified additives, it can cause the DPF system to be damaged and white smoke can be emitted. (if equipped)
- Do not let any petrol or water enter the tank. This would make it necessary to drain it out and to bleed the

lines to avoid jamming the injection pump and damaging the engine.

Biodiesel

Commercially supplied diesel blends of no more than 7% biodiesel, commonly known as "B7 diesel" may be used in your vehicle if biodiesel meets EN 14214 or equivalent specifications. (EN stands for "European Norm"). The use of biofuels exceeding 7% made from rapeseed methyl ester (RME), fatty acid methyl ester (FAME), vegetable oil methyl ester (VME) etc. or mixing diesel exceeding 7% with biodiesel will cause increased wear or damage to the engine and fuel system. Repair or replacement of worn or damaged components due to the use of non approved fuels will not be covered by the manufactures warranty.

CAUTION

- Never use any fuel, whether diesel or B7 biodiesel or otherwise, that fails to meet the latest petroleum industry specification. (if equipped)
- Never use any fuel additives or treatments that are not recommended or approved by the vehicle manufacturer. (if equipped)

Biodiesel (for New Zealand)

Commercially supplied Diesel blends of no more than 7% biodiesel, commonly known as "B7 Diesel" may be used in your vehicle if the Biodiesel meets EN 14214 or equivalent specifications. (EN stands for "European Norm"). The use of biofuels exceeding 7% made from rapeseed methylester (RME), vegetable oil methylester (VME) etc. or mixing diesel exceeding 7% with biodiesel will cause increased wear or damage to the engine and fuel system. Repair or replacement of worn or damaged components due to the use of non approved fuels will not be covered by the manufactures warranty.

CAUTION

Never use any fuel, whether diesel, B7 biodiesel or otherwise, that fails to meet the latest petroleum industry specification. Never use any fuel additives or treatments that are not recommended or approved by the vehicle manufacturer.

Vehicle modifications

This vehicle should not be modified. Modification of your vehicle could affect its performance, safety or durability and may even violate governmental safety and emissions regulations.

In addition, damage or performance problems resulting from any modification may not be covered under warranty.

- If you use unauthorised electronic devices, it may cause the vehicle to operate abnormally, wire damage, battery discharge and fire. For your safety, do not use unauthorised electronic devices.

Vehicle break-in process

By following a few simple precautions for the first 1,000 km (600 miles) you may increase the performance, economy and life of your vehicle.

- Do not race the engine.
- Whilst driving, keep your engine speed (rpm, or revolutions per minute) within 3,000 rpm.
- Do not maintain a single speed for long periods of time, either fast or slow. Varying engine speed is needed to properly break-in the engine.
- Avoid hard stops, except in emergencies, to allow the brakes to seat properly.
- Don't tow a trailer during the first 2,000 km (1,200 miles) of operation.
- Fuel economy and engine performance may vary depending on vehicle break-in process and be stabilized after 6,000 km (4,000 miles). New engines may consume more oil during the vehicle break-in period.

Risk of burns when parking or stopping vehicle

WARNING

- Do not park or stop the vehicle near flammable items such as leaves, paper, oil, and tyre. Such items placed near the exhaust system can become a fire hazard.
 - When an engine idles at a high speed with the rear side of the vehicle touching the wall, heat of the exhaust gas can cause discoloration or fire. Keep enough space between the rear part of the vehicle and the wall.
 - Be sure not to touch the exhaust/catalytic systems whilst engine is running or right after the engine is turned off. There is a risk of burns since the systems are extremely hot.
-

Vehicle handling instructions

As with other vehicles of this type, failure to operate this vehicle correctly may result in loss of control, an accident or vehicle rollover.

Specific design characteristics (higher ground clearance, track, etc.) give this vehicle a higher centre of gravity than other types of vehicles. In other words they are not designed for cornering at the same speeds as conventional 2-wheel drive vehicles.

Avoid sharp turns or abrupt manoeuvres. Again, failure to operate this vehicle correctly may result in loss of control, an accident or vehicle rollover.

Be sure to read the "Reducing the risk of a rollover" on page 6-46.

Open Source Software Notice

This vehicle contains software with open source licenses.

Open source software information including the source code, copyright notices and referred license terms may be obtained on the website

<http://worldwide.kia.com/int/open-source>

Kia Corporation will provide the open source code to you in storage medium such as CD-ROM for minimum charge covering the cost of performing source distribution upon email request to

opensource@kia.com

within a period of 3 years from the date of product purchase.

Importer information for United Kingdom

The UKCA logo consists of the letters 'UK' stacked above 'CA' in a bold, black, sans-serif font. The letters are centered within a light beige rectangular background.

ONQ5052179L

Name : Kia UK Limited

Address : Kia UK Limited, Walton Green,
Walton-On-Thames, Surrey, KT12 1FJ,
UK

Your vehicle at a glance **2**

| | |
|---------------------------------|-----|
| Exterior overview | 2-2 |
| Interior overview | 2-5 |
| Instrument panel overview | 2-7 |
| Engine compartment..... | 2-9 |

Your vehicle at a glance

Exterior overview

Front view



* The actual features in your vehicle may not necessarily be available due to the selected options or regions.

- | | |
|----------------------------------|------------|
| 1. Bonnet | 4-28 |
| 2. Head lamp | 4-60, 9-72 |
| 3. Wheel and tyre | 9-49, 10-6 |
| 4. Outside rear view mirror | 4-39 |
| 5. Panorama sunroof | 4-32 |
| 6. Front windscreen wiper blades | 4-66, 9-45 |
| 7. Windows | 4-24 |
| 8. Front ultrasonic sensor | 7-112 |
| 9. Front radar | 7-14, 7-70 |
| 10. Front view camera | 7-5, 7-14 |

| | |
|----------------------------|------|
| 11. Front fog lamp | 9-71 |
| 12. Roof rack | 4-97 |
| 13. Wide-front view camera | 7-89 |

Rear view



ONQ5011002L

* The actual features in your vehicle may not necessarily be available due to the selected options or regions.

| | |
|---------------------------|------------|
| 1. Doors | 4-12 |
| 2. Fuel filler door | 4-30 |
| 3. Rear combination lamp | 9-72, 9-73 |
| 4. High mounted stop lamp | 9-72 |
| 5. Tailgate | 4-18 |
| 6. Antenna | 5-2 |
| 7. Wide-rear view camera | 7-86 |
| 8. Rear ultrasonic sensor | 7-109 |
| 9. Rear wiper | 4-66, 9-45 |

Your vehicle at a glance

Exterior overview

10.Rear fog lamp

9-72

11.Backup lamp

9-72

Interior overview



* The actual features in your vehicle may not necessarily be available due to the selected options or regions.

- | | |
|---|------|
| 1. Inside door handle | 4-13 |
| 2. Seat position memory system | 4-17 |
| 3. Outside rearview mirror control switch | 4-39 |
| 4. Outside rearview mirror folding switch | 4-39 |
| 5. Central door lock/unlock switch | 4-13 |
| 6. Power window switches (Front) | 4-25 |
| 7. Power window switches (Rear) | 4-25 |
| 8. Power window lock button | 4-26 |
| 9. Steering wheel tilt/telescopic lever | 4-36 |
| 10. Steering wheel | 4-36 |
| 11. Headlight levelling adjustment switch | 4-66 |
| 12. ESC OFF button | 6-33 |
| 13. EPB switch | 6-28 |

| | |
|-------------------------------------|------|
| 14.Power tailgate open/close button | 4-19 |
| 15.Bonnet release lever | 4-28 |
| 16.Instrument panel fuse | 9-58 |
| 17.Seat | 3-3 |
| 18.Shift lever/Shift dial | 6-10 |
| 19.Brake pedal | 6-25 |

Instrument panel overview



ONQ5011005R_2

* The actual features in your vehicle may not necessarily be available due to the selected options or regions.

- | | |
|---|------------------|
| 1. Audio remote control button | 5-8 |
| 2. Driver's front air bag | 3-38 |
| 3. Horn | 4-38 |
| 4. Driving Assist button | 7-68, 7-70 |
| 5. Instrument cluster | 4-41 |
| 6. Light control/turn signals lever | 4-60 |
| Wiper and washer control lever | 4-66 |
| 7. Infotainment system | 4-98 |
| 8. Hazard warning flasher switch | 8-3 |
| 9. Climate control system | 4-72, 4-78, 4-80 |
| Infotainment/climate switchable controller | 4-80 |
| 10. ENGINE START/STOP button | 6-6, 6-6 |
| 11. Front seat warmer and air ventilation seat button | 4-90 |

| | |
|---|---------------------|
| 12.Steering wheel heater button | 4-37 |
| 13.DBC button | 6-34 |
| 14.AUTO HOLD button | 6-31 |
| 15.Parking Safety button | 7-109, 7-112, 7-123 |
| 16.Parking/View button | 7-86, 7-123 |
| 17.Drive mode integrated control system | 6-38, 6-40 |
| 18.Wireless smartphone charging system | 4-93 |
| 19.Centre console storage box | 4-88 |
| 20.Passenger's front air bag | 3-38 |
| 21.Glove box | 4-90 |

Engine compartment

Smartstream G2.5 GDi



2

Smartstream G1.6 T-GDi



Smartstream G2.0



Smartstream D2.0



* The actual engine room in the vehicle may differ from the illustration.

- 1. Engine coolant reservoir 9-38
- 2. Brake fluid reservoir 9-40
- 3. Air cleaner 9-43
- 4. Engine oil filler cap 9-35
- 5. Engine oil dipstick 9-35
- 6. Windscreen washer fluid reservoir 9-41
- 7. Positive battery terminal (+) 8-5, 9-47
- 8. Negative battery terminal (-) 8-5, 9-47
- 9. Fuse box 9-56

Safety features of your vehicle **3**

| | |
|---|-------------|
| Seat | 3-3 |
| • Feature of seat leather | 3-4 |
| • Infotainment system..... | 3-4 |
| • Adjusting the front seat..... | 3-4 |
| • Seatback pocket..... | 3-5 |
| • Adjusting the rear seat | 3-7 |
| Headrest | 3-9 |
| • Adjusting the headrest | 3-9 |
| • Removing/reinstalling the headrest | 3-10 |
| Armrest | 3-11 |
| • Adjusting the armrest..... | 3-11 |
| Seat belts | 3-12 |
| • Seat belt restraint system..... | 3-13 |
| • Seat belt precautions..... | 3-19 |
| • Care of seat belts | 3-21 |
| Child restraint system (CRS) | 3-22 |
| • Our recommendation: Children always in the rear | 3-22 |
| • Selecting a Child Restraint System (CRS) | 3-22 |
| • Installing a Child Restraint System (CRS)..... | 3-24 |
| ISOFIX anchorage and top-tether anchorage (ISOFIX anchorage system) for children | 3-24 |
| • Securing a Child Restraint System with the "ISOFIX Anchorage System"..... | 3-25 |
| • Securing a Child Restraint System seat with "Top-tether Anchorage" system | 3-25 |
| • Securing a Child Restraint System with a lap/shoulder belt..... | 3-26 |
| • Suitability of each seating position for belted & ISOFIX Child Restraint Systems (CRS) according to UN regulations..... | 3-27 |
| • Suitability of each seating position for belted & ISOFIX Child Restraint Systems (CRS) according to UN regulations..... | 3-29 |

3 Safety features of your vehicle

| | |
|---|-------------|
| Air bag - supplemental restraint system | 3-31 |
| • Air bag warning and indicator light | 3-33 |
| • Passenger's front air bag ON/OFF switch | 3-34 |
| • SRS components and functions | 3-36 |
| • Driver's and passenger's front air bag | 3-38 |
| • Side air bag and front centre air bag..... | 3-39 |
| • Curtain air bag | 3-41 |
| • Air bag collision sensors | 3-43 |
| • Air bag inflation conditions..... | 3-44 |
| • Air bag non-inflation conditions..... | 3-45 |
| • SRS care | 3-47 |
| • Additional safety precautions..... | 3-48 |
| • Adding equipment to or modifying your air bag-equipped vehicle..... | 3-49 |
| • Air bag warning labels..... | 3-49 |

Safety features of your vehicle

Seat

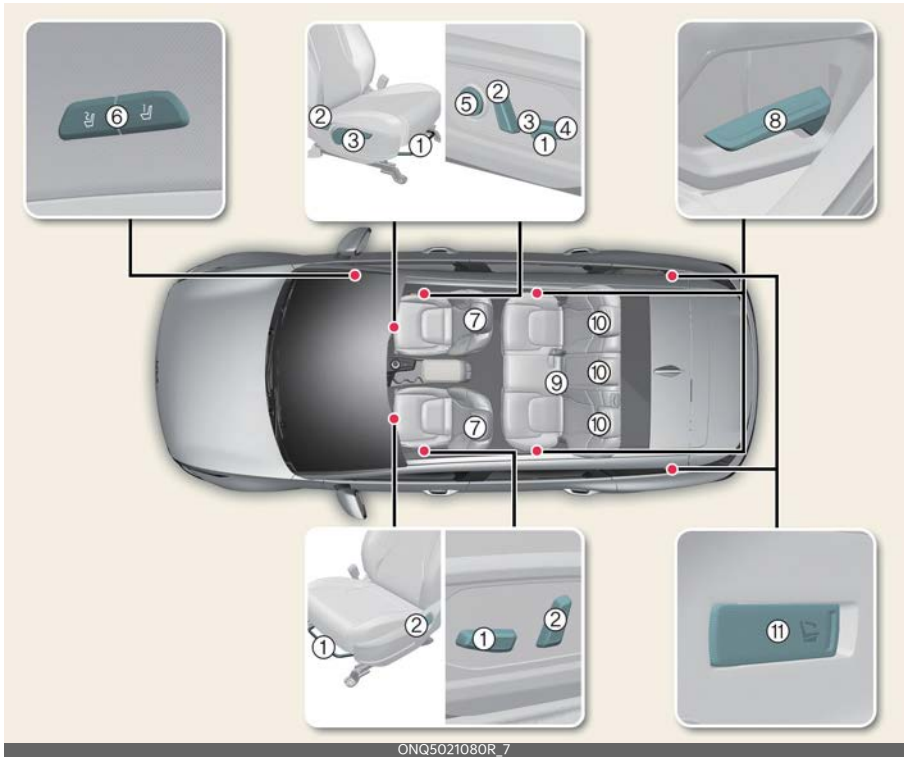

ONQ5021080R_7

* The actual features in your vehicle may not necessarily be available due to the selected options or regions.

Front seat

- 1 Forward and backward
- 2 Seatback angle
- 3 Seat height
- 4 Seat cushion tilt
- 5 Lumbar support
- 6 Driver position memory system
- 7 Headrest

2nd-row seat

- 8. Seatback angle/folding
- 9. Armrest
- 10. Headrest
- 11. Seatback folding

Feature of seat leather

- Our car seats are upholstered with a combination of artificial and genuine leather. The genuine leather is made from the outer skin of an animal, which goes through a special process to be available for use. Since it is a natural substance, each part differs in thickness or density. Also, wrinkles could appear depending on the temperature and humidity.
- The seat cover is made of stretchable material to improve comfort of passengers.
- The parts contacting the body are curved and the side supporting area is high which provides driving comfort and stability.
- Wrinkles may appear naturally from usage. It is not a fault of the product.

⚠ CAUTION

- Wrinkles or abrasions which appear naturally from usage are not covered by warranty.
- Belts with metallic accessories, zippers or keys inside the back pocket may damage the seat fabric.
- Make sure not to wet the seat. It may change the leather.
- Jeans or clothes which could bleach may contaminate the surface of the seat covering fabric.

Infotainment system

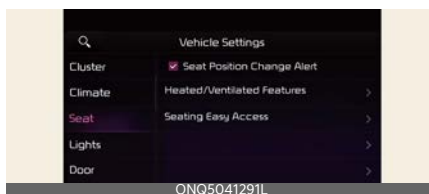

Select **Settings** → **Vehicle** → **Seat** from the Settings menu in the infotainment system screen, you may use various convenience functions.

- **Seat Position Change Alert:** When the seat position changes, details of the change are shown with a seat image.
- **Heated/Ventilated Features**
 - **Auto. Controls That Use Climate Control Settings** (for driver's seat): The seat temperature is automatically controlled.
- **Seating Easy Access**
 - **Seat Slide Easy Access:** the seat automatically moves when the driver enters or leaves the vehicle may be selected.

If your vehicle is equipped with an infotainment system, you can learn how to setup on the website via QR code in the infotainment quick reference guide.

* The information provided may differ according to which functions are applicable to your vehicle.

Adjusting the front seat

Operation

1. The seat can be adjusted by using the control levers located on the outside of the seat cushion.

*** INFORMATION**

- Adjust the seat before driving, and make sure the seat is locked securely by trying to move without using the lever. If the seat moves, it is not locked properly.
- The infotainment system may change after software updates. For more information, refer to the manual provided in the infotainment system and the quick reference guide.

1. Forward/backward
2. Seatback angle
3. Seat height
4. Seat cushion tilt

Lumbar support (if equipped)



- 1 Increase support
- 2 Decrease support

Manual seat



1. Forward/backward
2. Seatback angle
3. Seat height

Seatback pocket



- 1 Seatback pocket
- 2 USB charger (if equipped)

Power seat (if equipped)



⚠ WARNING

- Loose objects in the driver's foot area could interfere with the operation of the foot pedals, possibly causing an accident.
- When you return the seatback to its upright position, hold the seatback and return it slowly and be sure there are no other occupants around the seat. If the seatback is returned without being held and controlled, the

back of the seat could spring forward resulting in accidental injury to a person struck by the seatback.

- Riding in a vehicle with the seatback reclined could lead to serious or fatal injury in an accident.
If a seat is reclined during an accident, the occupant's hips may slide under the lap portion of the seatbelt, applying great force to the unprotected abdomen. Serious or fatal internal injuries could result. The driver must advise the passenger to keep the seatback in an upright position whenever the vehicle is in motion.
- Do not use a sitting cushion that reduces friction between the seat and passenger. The passenger's hips may slide under the lap portion of the seat belt during an accident or a sudden stop. Serious or fatal internal injuries could result because the seat belt can't operate normally.
- Never attempt to adjust any seat whilst the vehicle is moving. This could result in loss of control, and an accident causing death, serious injury, or property damage.
- Do not allow anything to interfere with the normal position of the seatback. Storing items against a seatback or in any other way interfering with proper locking of a seatback could result in serious or fatal injury in a sudden stop or collision.
- Always drive and ride with your seatback upright and the lap portion of the seat belt snug and low across the hips. This is the best position to protect you in case of an accident.
- In order to avoid unnecessary and perhaps severe air bag injuries, always sit as far back as possible from

the steering wheel whilst maintaining comfortable control of the vehicle. We recommend that your chest is at least 250 mm (10 inches) away from the steering wheel.

- The rear seatback must be securely latched. If not, passengers and objects could be thrown forward resulting in serious injury or death in the event of a sudden stop or collision.
- Luggage and other cargo should be laid flat in the cargo area. If objects are large, heavy, or must be piled, they must be secured. Under no circumstances should cargo be piled higher than the seatbacks. Failure to follow these warnings could result in serious injury or death in the event of a sudden stop, collision or rollover.
- No passenger should ride in the cargo area or sit or lie on folded seatbacks whilst the vehicle is moving. All passengers must be properly seated in seats and restrained properly whilst riding.
- When resetting the seatback to the upright position, make sure it is securely latched by pushing it forward and backwards.
- To avoid the possibility of burns, do not remove the carpet in the cargo area. Emission control devices beneath this floor generate high temperatures.
- After adjusting the seat, always check that it is securely locked into place by attempting to move the seat forward or backward without using the lock release lever. Sudden or unexpected movement of the driver's seat could cause you to lose control of the vehicle resulting in an accident.

- Do not adjust the seat whilst wearing seat belts. Moving the seat cushion forward may cause strong pressure on the abdomen.
- Use extreme caution so that hands or other objects are not caught in the seat mechanisms whilst the seat is moving.
- Do not put a cigarette lighter on the floor or seat. When you operate the seat, gas may gush out of the lighter and cause fire.
- If there are occupants in the rear seats, be careful whilst adjusting the front seat position.
- Use extreme caution when picking small objects trapped under the seats or between the seat and the centre console. Your hands might be cut or injured by the sharp edges of the seat mechanism.
- The power seat is operable with the ignition OFF. Therefore, children should never be left unattended in the car.

CAUTION

- The power seat is driven by an electric motor. Stop operating once the adjustment is completed. Excessive operation may damage the electrical equipment.
- When in operation, the power seat consumes a large amount of electrical power. To prevent unnecessary charging system drain, don't adjust the power seat longer than necessary whilst the engine is not running.
- Do not operate two or more power seat control switches at the same time. Doing so may result in power

seat motor or electrical component malfunction.

Adjusting the rear seat

Adjusting rear seatback angle



Operation

1. Pull up the seatback recline lever.
2. Hold the lever and adjust the seatback of the seat to the position you desire.
3. Release the lever and make sure the seatback is locked in place. (The lever MUST return to its original position for the seatback to lock.)

Folding rear seatback

Type A



Type B



- 1 Left side seatback
- 2 Right side seatback

Operation

1. Insert the seat belt buckle/webbing in the pocket/guide.
2. For type A, pull up the seatback folding lever, then fold the seat down.
3. For type B, pull the seatback folding lever(1) and (2) in the luggage room.

⚠ WARNING

- Never attempt to adjust whilst the vehicle is moving or the rear seat is occupied as the seat may suddenly move and cause the passenger on the seat to be injured.
- The purpose of the fold-down rear seatbacks is to allow you to carry longer objects that could not be accommodated in the cargo area. Never allow passengers to sit on top of the folded down seatback whilst the vehicle is moving. This is not a proper seating position and no seat belts are

available for use. This could result in serious injury or death in case of an accident or sudden stop. Objects carried on the folded down seatback should not extend higher than the top of the front seatbacks. This could allow cargo to slide forward and cause injury or damage during sudden stops.

- Do not fold the rear seats if passengers, pets or luggage are in the rear seats. It may cause injury or damage to passengers, pets or luggage.
- When you return the seatback to its upright position, hold the seatback and return it slowly. If the seatback is returned without holding it, the back of the seat could spring forward resulting in injury caused by being struck by the seatback.
- Cargo should always be secured to prevent it from being thrown about the vehicle in a collision and causing injury to the vehicle occupants. Do not place objects in the rear seats, since they cannot be properly secured and may hit the front seat occupants in a collision.
- Make sure the engine is off, the automatic/dual clutch transmission is in P (Park) or the manual transmission is in R (Reverse) or 1st, and the parking brake is securely applied whenever loading or unloading cargo. Failure to take these steps may allow the vehicle to move if the shift lever or dial is inadvertently moved to another position.
- Never attempt to adjust whilst the vehicle is moving or the rear seat is occupied as the seat may suddenly move and cause the passenger on the seat to be injured.

CAUTION

- When returning the rear seatbacks to the upright position, remember to return the rear shoulder belts to their proper position. Routing the seat belt webbing through the rear seat belt guides will help keep the belts from being trapped behind or under the seats.
- When you fold the rear seatback, insert the buckle in the pocket between the rear seatback and cushion. Doing so can prevent the buckle from being damaged by the rear seatback.

Headrest

The seats are equipped with a headrest for the occupant's safety and comfort.

**Adjusting the headrest**

Front



Rear

**Operation**

1. Pull up the headrest to raise.
2. Push and hold the release button (1) to lower the headrest.

*** INFORMATION**

The headrest may be adjusted forward to 3 different positions by pulling the headrest forward.

Removing/reinstalling the headrest

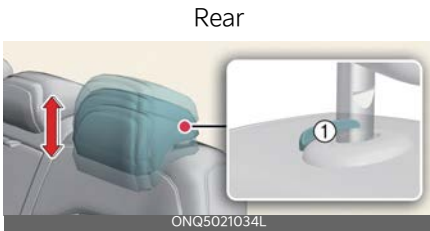
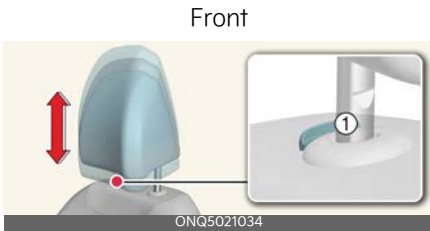

- Do not operate the vehicle with the headrests removed or reversed as severe injury to the occupants may occur in the event of an accident. Headrests may provide protection against neck injuries when properly adjusted.
- Do not adjust the headrest position of the driver's seat whilst the vehicle is in motion.
- Make sure the headrest locks in position after adjusting it to properly protect the occupants.
- Never allow anyone to ride in a seat with the headrests removed.
- Always make sure the headrest locks into position after reinstalling and adjusting it properly.

Operation

1. Push and hold the release button (1) whilst pulling the headrest up.
2. Do it in reverse order to reinstall the headrest.

⚠ WARNING

- For maximum effectiveness in case of an accident, the headrest should be adjusted so the middle of the headrest is at the same height of the centre of gravity of an occupant's head. Generally, the centre of gravity of most people's head is similar with the height of the top of their eyes. Also, adjust the headrest as close to your head as possible. For this reason, the use of a cushion that holds the body away from the seatback is not recommended.

⚠ CAUTION

- When there is no occupant in the rear seats, adjust the height of the headrest to the lowest position. The rear seat headrest can reduce the visibility of the rear area.
- If you recline the seatback towards the front with the headrest and seat cushion raised, the headrest may come in contact with the sun visor or other parts of the vehicle.



Armrest

Adjusting the armrest



Operation

1. Pull the armrest forward from the seatback.

⚠ WARNING

Do not put heavy or sharp objects in the seatback pockets or inside the armrest storage area. In an accident they could come loose from the pocket and injure vehicle occupants.

⚠ CAUTION

Do not store small or heavy objects. It might fly off and cause injuries.

*** NOTICE**

Be careful when loading cargo through the rear passenger seats to prevent damage to the vehicle interior.

Seat belts

Seat belts are designed to bear upon the bony structure of the body, and should be worn low across the front of the pelvis, chest and shoulders.

WARNING

- For maximum restraint system protection, the seat belts must always be used whenever the car is moving.
- Seat belts are most effective when seatbacks are in the upright position.
- Children age 13 and younger must always be properly restrained in the rear seat. Never allow children to ride in the front passenger seat. If a child over 13 must be seated in the front seat, he/she must be properly belted and the seat should be moved as far back as possible.
- Never wear the shoulder belt under your arm or behind your back. An improperly positioned shoulder belt can cause serious injuries in a crash. The shoulder belt should be positioned midway over your shoulder across your collarbone.
- Never wear a seat belt over fragile objects. If there is a sudden stop or impact, the seat belt can damage it.
- Avoid wearing twisted seat belts. A twisted belt can't do its job as well. In a collision, it could even cut into you. Be sure the belt webbing is straight and not twisted.
- Be careful not to damage the belt webbing or hardware. If the belt webbing or hardware is damaged, replace it.
- Seat belts are designed to bear upon the bony structure of the body, and should be worn low across the front of the pelvis or the pelvis, chest and shoulders, as applicable; wearing the lap section of the belt across the abdominal area must be avoided. Seat belts should be adjusted as firmly as possible, consistent with comfort, to provide the protection for which they have been designed. A slack belt will greatly reduce the protection afforded to the wearer. Care should be taken to avoid contamination of the webbing with polishes, oils and chemicals, and particularly battery acid. Cleaning may safely be carried out using mild soap and water. The belt should be replaced if webbing becomes frayed, contaminated or damaged. It is essential to replace the entire assembly after it has been worn in a severe impact even if damage to the assembly is not obvious. Belts should not be worn with straps twisted. Each belt assembly must only be used by one occupant; it is dangerous to put a belt around a child being carried on the occupant's lap.
- No modifications or additions should be made by the user which will either prevent the seat belt adjusting devices from operating to remove slack, or prevent the seat belt assembly from being adjusted to remove slack.
- When you fasten the seat belt, be careful not to latch the seat belt in buckles of other seat. It's very dangerous and you may not be protected by the seat belt properly.
- Do not unfasten the seat belt and do not fasten and unfasten the seat belt repeatedly whilst driving. This could result in loss of control, and an accident causing death, serious injury, or property damage.

- When fastening the seat belt, make sure that the seat belt does not pass over objects that are hard or can break easily.
- Make sure there is nothing in the buckle. The seat belt may not be fastened securely.

Seat belt restraint system

Seat belt warning light

Front seat belt warning light (if equipped)



Operating condition(s)

- When the vehicle is running
 - The front seat belt warning light will appear for approximately 6 seconds.
- When the front seat belt is unfastened
 - For driver's seat, the front seat belt warning chime will sound for approximately 6 seconds. (if equipped)
 - The front seat belt warning light will stay appeared. (if equipped)
- When the front seat belt is unfastened during driving and the vehicle speed is under approximately 20 km/h (12 mph)
 - The front seat belt warning light will appear
- When the vehicle speed is over approximately 20 km/h (12 mph)

- The warning chime will sound for approximately 100 seconds
- The front seat belt warning light will blink.

Rear passenger's seat belt warning lights (if equipped)



- Rear seat: (1) Driver's side, (2) Centre, (3) Passenger's side

Operating condition(s)

For rear left and right seat (for Australia and New Zealand)

- When the vehicle is running
 - Rear passenger's seat belt warning light will appear for approximately 6 seconds.
- When the seat belt is unfastened during driving and the vehicle speed is under approximately 20 km/h (12 mph)
 - Rear passenger's seat belt warning light will stay appeared.
- When the vehicle speed is over approximately 20 km/h (12 mph)
 - Rear passenger's seat belt warning chime will sound for approximately 35 seconds
 - Rear passenger's seat belt warning light will blink.
- When the vehicle is driven without the seat belt fastened, or the driver has unfastened the seat belt when the

vehicle speed is over approximately 20 km/h (12 mph)

- Rear passenger's seat belt warning chime will sound for approximately 35 seconds
- Rear passenger's seat belt warning light will blink.

For rear centre seat (for Australia and New Zealand)

- When the vehicle is running
 - Rear passenger's seat belt warning light will appear for approximately 6 seconds.
- When the seat belt is unfastened during driving and the vehicle speed is under approximately 20 km/h (12 mph)
 - Rear passenger's seat belt warning light will appear for approximately 70 seconds.
- When the vehicle speed is over approximately 20 km/h (12 mph)
 - Rear passenger's seat belt warning chime will sound for approximately 35 seconds
 - Rear passenger's seat belt warning light will blink.

For all rear seats (except Australia and New Zealand)

- When the vehicle is running
 - Rear passenger's seat belt warning light will appear for approximately 6 seconds.
- When the seat belt is unfastened during driving and the vehicle speed is under approximately 20 km/h (12 mph)
 - Rear passenger's seat belt warning light will appear for approximately 70 seconds.

- When the vehicle speed is over approximately 20 km/h (12 mph)
 - Rear passenger's seat belt warning chime will sound for approximately 35 seconds
 - Rear passenger's seat belt warning light will blink.

Non-operating condition(s)

- When the rear door is opened or closed, and the vehicle speed is under 10 km/h (6 mph)
 - Seat belt warning light and the seat belt warning chime will not work even if the vehicle speed is over approximately 20 km/h (12 mph).

WARNING

Riding in an improper position adversely affects the front seat belt warning system. It is important for the driver to instruct the passenger to properly be seated as instructed in this manual.

NOTICE

- Although the front passenger seat is not occupied, the seat belt warning light will blink or appear for 6 seconds.
- The front passenger's seat belt warning may operate when luggage is placed.

Fastening and releasing the seat belt

3-point system with emergency locking retractor (if equipped)



Operation

1. Insert the metal tab into the buckle.
2. Press the release button in the locking buckle.

* INFORMATION

- There will be an audible "click" when the tab locks into the buckle.



- 1 Rear right seat belt fastening buckle
- 2 Rear centre seat belt fastening buckle (with the "CENTER" mark)
- 3 Rear left seat belt fastening buckle

⚠ WARNING

- You should place the lap belt portion as low as possible and snugly across your hips, not on your waist. If the lap belt is located too high on your waist, it may increase the chance of injury in the event of a collision. Both arms should not be under or over the belt. Rather, one should be over and the other under, as shown in the illustra-

tion. Never wear the seat belt under the arm near the door.

- Prior to fastening the rear seat belts, ensure the latch matches the seat belt buckle. Forcefully fastening the left or right seat belt to the centre buckle can result in an improper fastening scenario that will not protect you in an accident.

⚠ CAUTION

Do NOT fold down the left portion of the rear seatback when the rear centre seat belt is buckled. ALWAYS UNBUCKLE the rear centre seat belt before folding down the left portion of the rear seatback. If the rear centre seat belt is buckled when the left portion of the rear seatback is folded down, distortion and damage to the top portion of the seatback and seat belt garnish may result, causing the seatback to lock into the folded down position.

Adjusting height of the shoulder belt



Operation

1. Pull the height adjuster up (1).
2. Press the height adjuster button (2) and push the height adjuster down (3).

⚠ WARNING

- After a collision, the seat belt system should be inspected to ensure it is

operating normally. Replace any belts that are not functioning appropriately.

- Verify the shoulder belt anchor is locked into position at the appropriate height. Never position the shoulder belt across your neck or face.

CAUTION

- Do not force to lock the left or right seat belt into the centre seat belt buckle. Make sure to lock the rear centre seat belt into the centre seat belt buckle. If not, the improperly fastened seat belt will not be able to provide protection.
- When pulling out to wear the seat belt, the tongue should be slowly pulled out of the seat belt guide so that the seat belt guide does not come off the trim.

NOTICE

If you are not able to pull out the seat belt from the retractor, firmly pull the belt out and release it. Then you will be able to pull the belt out smoothly.

Fastening and releasing the rear centre seat belt (lap belt) - 2-point static type belt (if equipped)

Operation

1. To fasten a 2-point static type belt, insert the metal tab (1) into the locking buckle (2). There will be an audible "click" when the tab locks into the buckle.



2. Check to make sure the belt is properly locked and that the belt is not twisted. With a 2-point static type seat belt, the length must be adjusted manually so it fits snugly around your body.
3. Fasten the belt and pull on the loose end to tighten.



4. The belt should be placed as low as possible on your hips (1), not on your waist. If the belt is too high, it could increase the possibility of your being injured in an accident.



5. When using the rear centre seat belt, the buckle with the "CENTER" mark must be used.



- When you want to release the seat belt, press the button (1) in the locking buckle.



⚠ WARNING

The centre lap belt latching mechanism is different from those for the rear seat shoulder belts. When fastening the rear seat shoulder belts or the centre lap belt, make sure they are inserted into the correct buckles to obtain maximum protection from the seat belt system and assure proper operation.

Pre-tensioner seat belt

Your vehicle is equipped with driver's, front passenger's and rear passengers' (if equipped) pre-tensioner seat belts.



The seat belt pre-tensioner system consists mainly of the following components.

Your vehicle is equipped with driver's and front passenger's pre-tensioner seat belts (retractor pretensioner).

The purpose of the pre-tensioner is to make sure that the seat belts fit tightly against the occupant's body in certain collisions. The pre-tensioner seat belts can be activated, where the frontal colli-

sion is severe enough, together with the air bags.

When the vehicle stops suddenly, or if the occupant tries to lean forward too quickly, the seat belt retractor will lock-into position. In certain frontal collisions, the pre-tensioner will activate and pull the seat belt into tighter contact against the occupant's body.

- 1 Retractor Pretensioner** The purpose of the retractor pretensioner is to make sure that the shoulder belts fit in tightly against the occupant's upper body in certain frontal collisions.

If the system senses excessive tension on the driver or passenger's seat belt when the pre-tensioner system activates, the load limiter inside the retractor pre-tensioner will release some of the pressure on the affected seat belt. (if equipped)



- 1** SRS air bag warning light
- 2** Front retractor pre-tensioner assembly
- 3** SRS control module

Operating condition(s)

- When the vehicle stops suddenly, or if the occupant tries to lean forward too quickly, the seat belt retractor will lock into position.
- In certain frontal collisions, the pre-tensioner will activate and pull the seat belt into tighter contact against the occupant's body.

- When the system senses excessive tension on the driver or passenger's seat belt when the pre-tensioner system activates, the load limiter inside the retractor pre-tensioner will release some of the pressure on the affected seat belt.

WARNING

- For your safety, be sure that the belt webbing is not loose or twisted and always sit properly on your seat.
- To obtain maximum benefit from a pre-tensioner seat belt:
 1. The seatbelt must be working correctly and adjusted to the proper position. Please read and follow all of the important information and precautions about your vehicle's occupant safety features - including seat belts and air bags that are provided in this manual.
 2. Be sure you and your passengers always wear seat belts properly.
- Pre-tensioners seat belts systems are designed to operate only one time. After activation, pre-tensioner seat belts must be replaced. All seat belts of any type should always be replaced after they have been worn during a collision.
- The pre-tensioner seat belt assembly mechanisms become hot during activation. Do not touch the pre-tensioner seat belt assemblies for several minutes after they have been activated.
- Do not attempt to inspect or replace the pre-tensioner seat belts yourself. Have the system inspected by a professional workshop. Kia recommends to visit an authorised Kia dealer/service partner.
- Do not attempt to service or repair the pre-tensioner seat belt system in any manner.
- Improper handling of the pre-tensioner seat belt assemblies, and failure to heed the warnings not to strike, modify, inspect, replace, service or repair the pre-tensioner seat belt assemblies may lead to improper operation or inadvertent activation and serious injury.
- Always wear the seat belts when driving or riding in a motor vehicle.
- If the vehicle or pre-tensioner seat belt must be discarded, contact a professional workshop. Kia recommends to visit an authorised Kia dealer/service partner.
- Body work on the front area of the vehicle may damage the pre-tensioner seat belt system. Therefore, have the system serviced by a professional workshop. Kia recommends to visit an authorised Kia dealer/ service partner.

CAUTION

If the pre-tensioner seat belt is not working properly, the SRS air bag warning light will appear even if there is no malfunction of the SRS air bag. If the SRS air bag warning light does not appear when the ignition key is turned to ON, or if it remains appeared after illuminating for approximately 3~6 seconds, or if it appears whilst the vehicle is being driven, have the system inspected by a professional workshop. Kia recommends to visit an authorised Kia dealer/service partner.

*** NOTICE**

- The pre-tensioner will activate not only in a frontal collision but also in a side collision, if the vehicle is equipped with a side or curtain air bag.
- When the pre-tensioner seat belts are activated, a loud noise may be heard and fine dust, which may appear to be smoke, may be visible in the passenger compartment. These are normal operating conditions and are not hazardous.
- Although it is harmless, the fine dust may cause skin irritation and should not be breathed for prolonged periods. Wash all exposed skin areas thoroughly after an accident in which the pre-tensioner seat belts were activated.
- Because the sensor that activates the SRS air bag is connected with the pre-tensioner seat belt, the SRS air bag warning light on the instrument panel will appear for approximately 3~6 seconds after the vehicle is in ON position, and then it should turn off.

Seat belt precautions**⚠ WARNING**

All occupants of the vehicle must wear their seat belts at all times. Seat belts and child restraints reduce the risk of serious or fatal injuries for all occupants in the event of a collision or sudden stop. Without a seat belt, occupants could be shifted too close to a deploying air bag, strike the interior structure or be thrown from the vehicle. Properly worn seat belts greatly reduce these hazards. Always follow the precautions about

seat belts, air bags and occupant seat contained in this manual.

Infant or small child

You should be aware of the specific requirements in your country. Child and/or infant seats must be properly placed and installed in the rear seat.

*** INFORMATION**

Refer to "Child restraint system (CRS)" on page 3-22.

⚠ WARNING

Every person in your vehicle needs to be properly restrained at all times, including infants and children. Never hold a child in your arms or lap when riding in a vehicle. The violent forces created during a crash will tear the child from your arms and throw the child against the interior. Always use a child restraint appropriate for your child's height and weight.

*** NOTICE**

Small children are best protected from injury in an accident when properly restrained in the rear seat by a child restraint system that meets the requirements of the Safety Standards of your country. Before buying any child restraint system, make sure that it has label certifying that it meets Safety Standards of your country. The restraint must be appropriate for your child's height and weight. Check the label on the child restraint for this information. Refer to "Child restraint system (CRS)" on page 3-22.

Larger children

Children who are too large for child restraint systems should always occupy the rear seat and use the available lap/shoulder belts. The lap portion should be fastened and snugged on the hips and as low as possible. Check if the belt fits periodically. A child's squirming could put the belt out of position. Children are afforded the most safety in the event of an accident when they are restrained by a proper restraint system in the rear seat. If a larger child (over age 13) must be seated in the front seat, the child should be securely restrained by the available lap/shoulder belt and the seat should be placed in the rearmost position. Children age 13 and under should be restrained securely in the rear seat. NEVER place a child age 13 and under in the front seat. NEVER place a rear facing child seat in the front seat of a vehicle. If the shoulder belt portion slightly touches the child's neck or face, try placing the child closer to the centre of the vehicle. If the shoulder belt still touches their face or neck they need to be returned to a child restraint system.

WARNING

- Never allow a shoulder belt to be in contact with a child's neck or face whilst the vehicle is in motion.
- If seat belts are not properly worn and adjusted on children, there is a risk of death or serious injury.

Pregnant women

The use of a seat belt is recommended for pregnant women to lessen the chance of injury in an accident. When a seat belt is used, the lap belt portion should be placed as low and snugly as possible on the hips, not across the abdomen. For specific recommendations, consult a physician.

WARNING

Pregnant women must never place the lap portion of the safety belt over the area of the abdomen where the fetus is located or above the abdomen where the belt could crush the fetus during an impact.

Injured person

A seat belt should be used when an injured person is being transported. When this is necessary, you should consult a physician for recommendations.

One person per belt

Two people (including children) should never attempt to use a single seat belt. This could increase the severity of injuries in case of an accident.

Do not lie down

To reduce the chance of injuries in the event of an accident and to achieve maximum effectiveness of the restraint system, all passengers should be sitting up and the front seats should be in an upright position when the car is moving. A seat belt cannot provide proper protection if the person is lying down in the rear seat or if the front seat is in a reclined position.

⚠ WARNING

Riding with a reclined seatback increases your chance of serious or fatal injuries in the event of a collision or sudden stop. The protection of your restraint system (seat belts and air bags) is greatly reduced by reclining your seat. Seat belts must be snug against your hips and chest to work properly. The more the seatback is reclined, the greater the chance that an occupant's hips will slide under the lap belt causing serious internal injuries or the occupant's neck could strike the shoulder belt. Drivers and passengers should always sit well back in their seats, properly belted, and with the seatbacks upright.

Care of seat belts

Seat belt systems should never be disassembled or modified. In addition, care should be taken to assure that seat belts and belt hardware are not damaged by seat hinges, doors or other abuse.

⚠ WARNING

- When you return the rear seatback to its upright position after the rear seatback was folded down, be careful not to damage the seat belt webbing or buckle. Be sure that the webbing or buckle does not get caught or pinched in the rear seat. A seat belt with damaged webbing or buckle will not be as strong and could possibly fail during a collision or sudden stop, resulting in serious injury. If the webbing or buckles are damaged, get them replaced immediately.
- Seat belts can become hot in a vehicle that has been closed up in sunny

weather. They could burn infants and children.

Periodic inspection

It is recommended that all seat belts be inspected periodically for wear or damage of any kind. Any damaged parts should be replaced as soon as possible.

Keep belts clean and dry

Seat belts should be kept clean and dry. If belts become dirty, they can be cleaned by using a mild soap solution and warm water. Bleach, dye, strong detergents or abrasives should not be used because they may damage and weaken the fabric.

When to replace seat belts

Entire in-use seat belt assembly or assemblies should be replaced if the vehicle has been involved in an accident. This should be done even if no damage is visible. In this case, have the system replaced by a professional workshop. Kia recommends to consult an authorised Kia dealer/service partner.

Child restraint system (CRS)

Our recommendation: Children always in the rear

Infants and younger children must be restrained in an appropriate rearward-facing or forward-facing CRS that has first been properly secured to the seat of the vehicle. Read and comply with the instructions for installation and use provided by the manufacturer of the Child Restraint System.

Children under age 13 should always ride in the rear seats and must always be properly restrained to minimise the risk of injury in an accident, sudden stop or sudden manoeuvre.

According to accident statistics, children are safer when properly restrained in the rear seats than in the front seat. Children too large for a Child Restraint System must use the seat belts provided.

Most countries have regulations which require children to travel in approved Child Restraint Systems.

The laws governing the age or height/weight restrictions at which seat belts can be used instead of Child Restraint System differs among countries, so you should be aware of the specific requirements in your country, and where you are travelling.

Child Restraint Systems must be properly installed in the vehicle seat. Always use a commercially available Child Restraint System that meets the requirements of your country.

WARNING

- Always properly restrain children in the vehicle. Children of all ages are safer when riding in the rear seats. Never place a rearward-facing Child Restraint System on the front passen-

ger seat, unless the air bag is deactivated.

- Always follow the Child Restraint System manufacturer's instructions for installation and use.
- Always properly restrain your child in the Child Restraint System.
- Do not use an infant carrier or a child safety seat that "hooks" over a seat-back, it may not provide adequate protection in an accident.
- After an accident, have the system checked by a professional workshop. Kia recommends to visit an authorised Kia dealer/service partner.

Selecting a Child Restraint System (CRS)

Operation

1. Select a Child Restraint System based on your child's height and weight. The required label or the instructions for used typically provide this information.
2. Select a Child Restraint System that fits the vehicle seating position where it will be used.

INFORMATION

- Make sure the Child Restraint System has a label certifying that it meets the applicable Safety Standards of your country.

A Child Restraint System may only be installed if it was approved in accordance with the requirements of ECE-R44 or ECE-R129 or relevant regulation.

- Select a Child Restraint System based on your child's height and weight. The

required label or the instructions for use typically provide this information.

- Select a Child Restraint System that fits the vehicle seating position where it will be used.

For the suitability of Child Restraint Systems on the vehicle's seating positions, please refer to "Suitability of each seating position for belted & ISO-FIX Child Restraint Systems (CRS) according to UN regulations for Latin America (Information for vehicle users and CRS manufacturers)" on page 3-27.

- Read and comply with the warnings and instructions for installation and use provided with the Child Restraint System.

Child restraint system types

Forward/Rearward-facing Child Restraint System



A rearward-facing Child Restraint System provides restraint with the seating surface against the back of the child. The harness system holds the child in place, and in an accident, acts to keep the child positioned in the Child Restraint Systems and reduce the stress to the fragile neck and spinal cord.

All children under the age of one year must always ride in a rearward-facing Child Restraint System. There are different types of rearward-facing Child Restraint Systems: infant-only Child

Restraint Systems can only be used rearward-facing. Convertible and 3-in-1 Child Restraint Systems typically have higher height and weight limits for the rearward-facing position, allowing you to keep your child rearward-facing for a longer period of time.

Keep using Child Restraint Systems in the rearward-facing position as long as children fit within the height and weight limits allowed by the Child Restraint System's manufacturer.

A forward-facing Child Restraint System provides restraint for the child's body with a harness. Keep children in a forward-facing Child Restraint System with a harness until they reach the top height or weight limit allowed by your Child Restraint System's manufacturer.

Once your child outgrows the forward-facing Child Restraint System, your child is ready for a booster seat.

Booster seats

A booster seat is a Child Restraint System designed to improve the fit of the vehicle's seat belt system. A booster seat positions the seat belt so that it fits properly over the stronger parts of your child's body. Keep your children in booster seats until they are big enough to fit in a seat belt properly.

For a seat belt to fit properly, the lap belt must lie comfortable across the upper thighs, not the stomach. The shoulder belt should lie comfortable across the shoulder and chest and not across the neck or face. Children under age 13 must always be properly restrained to minimise the risk of injury in an accident, sudden stop or sudden manoeuvre.

Installing a Child Restraint System (CRS)

Operation

1. Properly secure the Child Restraint System to the vehicle.
2. Make sure the Child Restraint System is firmly secured.
3. Secure the child in the Child Restraint System.

⚠ WARNING

- Before installing your Child Restraint System always: Read and follow the instructions provided by the manufacturer of the Child Restraint System. Failure to follow all warnings and instructions could increase the risk of the serious injury or death if an accident occurs.
- If the vehicle's headrest prevents proper installation of a Child Restraint System, the headrest of the respective seating position shall be readjusted or entirely removed.

⚠ CAUTION

A Child Restraint System in a closed vehicle can become very hot. To prevent burns, check the seating surface and buckles before placing your child in the Child Restraint System.

ISOFIX anchorage and top-tether anchorage (ISOFIX anchorage system) for children

ISOFIX anchorages are metal bars built into the vehicle. There are two lower anchors for each ISOFIX seating position that will accommodate a Child Restraint System with lower attachments.

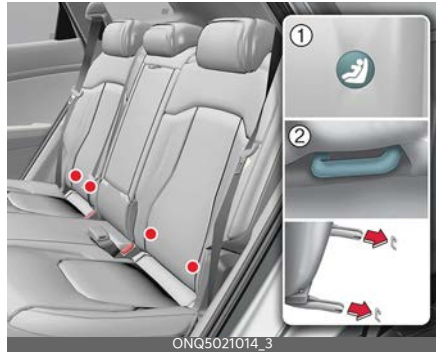

1. ISOFIX anchor position indicator
2. ISOFIX anchor

ISOFIX anchorages have been provided in the left and right outboard rear seating positions.



⚠ WARNING

Do not attempt to install a Child Restraint System using ISOFIX anchorages in the rear centre seating position. There are no ISOFIX anchorages provided for this seat. Using the outboard seat anchorages, for the CRS installation

on the rear centre seating position, can damage the anchorages.

Securing a Child Restraint System with the "ISOFIX Anchorage System"

To install a ISOFIX-compatible Child Restraint System in either of the rear outboard seating positions.

Operation

1. Move the seat belt buckle away from the ISOFIX anchorages.
2. Move any other objects away from the anchorages.
3. Place the Child Restraint System on the vehicle seat, then attach the seat to the ISOFIX anchorages according to the instructions provided by the Child Restraint System manufacturer.
4. Follow the instructions of the Child Restraint System's manufacturer for proper installation and connection of the ISOFIX attachments on the Child Restraint System to the ISOFIX anchorages.

⚠ WARNING

Take the following precautions when using the ISOFIX system:

- Read and follow all installation instructions provided with your Child Restraint System.
- To prevent the child from reaching and taking hold of unretracted seat belts, buckle all unused rear seat belts and retract the seat belt webbing behind the child. Children can be strangled if a shoulder belt becomes wrapped around their neck and the seat belt tightens.

- NEVER attach more than one Child Restraint System to a single anchorage. This could cause the anchor or attachment to come loose or break.
- Always have the ISOFIX (i- Size) system inspected by your dealer after an accident. An accident can damage the ISOFIX system and may not properly secure the Child Restraint System.

Securing a Child Restraint System seat with "Top-tether Anchorage" system



Operation

1. Route the Child Restraint System seat strap over the seatback.
2. Connect the top-tether to the top-tether anchorage,
3. Tighten the top-tether according to the instructions of your Child Restraint System's manufacturer.

⚠ WARNING

Take the following precautions when installing the top-tether:

- Read and follow all installation instructions provided with your Child Restraint System.
- NEVER attach more than one Child Restraint System to a single ISOFIX top-tether anchorage. This could cause the anchorage or attachment to come loose or break.
- Do not attach the top-tether to anything other than the correct top-tether anchorage. It may not work properly if attached to something else.
- Child restraint anchorages are designed to withstand only those loads imposed by correctly fitted child restraints. Under no circumstances are they to be used for adult seatbelts, harnesses, or for attaching other items or equipment to the vehicle.

Child Restraint System whilst feeding the shoulder belt back into the retractor.

4. Push and pull on the Child Restraint System to confirm that the seat belt is holding it firmly in place.
5. If your Child Restraint System manufacturer recommends the use of a top-tether with the lap/shoulder belt, see Securing a Child Restraint System seat with "Top-tether Anchorage" system section in this chapter.
6. To remove the Child Restraint System, press the release button on the buckle and then pull the lap/shoulder belt out of the Child Restraint System and allow the seatbelt to retract fully.

Securing a Child Restraint System with a lap/shoulder belt

When not using the ISOFIX system, all Child Restraint Systems must be secured to a rear seat with the lap part of a lap/shoulder belt.

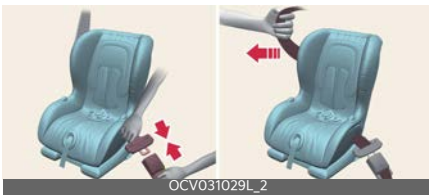

Operation

1. Place the Child Restraint System on a rear seat and route the lap/shoulder belt around or through the Child Restraint System.
2. Fasten the lap/shoulder belt latch into the buckle.
3. Remove as much slack from the belt as possible by pushing down on the

Suitability of each seating position for belted & ISOFIX Child Restraint Systems (CRS) according to UN regulations

(Information for use by vehicle users and CRS manufacturers)

- Yes : Suitable for fitment of the designated category of CRS
- No : Not suitable for fitment of the designated category of CRS
- "-": Not applicable

F: Forward facing

R: Rearward facing

| CRS categories | | Seating positions | | | | | |
|---|---------------------------------|-------------------|-----------------------------|--------------------------------|-------------|--------------------|-------------|
| | | 1, 2 | 3 | | 4 | 5 (3Point Belt) | 6 |
| | | | Airbag ON (or Activated) | Airbag Off (or Deactivated) | | | |
| Universal belted CRS | All mass groups | - | No | Yes ^{*1} F, R | Yes F, R | Yes F, R | Yes F, R |
| i-size CRS (If i-size symbol is not applied, No) | ISOFIX CRF (F2, F2X, R1, R2) | - | No | No | Yes F, R | - | Yes F, R |
| Carry-cot (ISOFIX lateral facing CRS) | ISOFIX CRF (L1, L2) | - | No | No | No | - | No |
| ISOFIX infant* CRS (* : ISOFIX baby CRS) | ISOFIX CRF (R1) | - | No | No | Yes R | - | Yes R |
| ISOFIX toddler CRS - small | ISOFIX CRF (F2,F2X, R2,R2X) | - | No | No | Yes F, R | - | Yes F, R |
| ISOFIX toddler CRS - large* (*: not booster seats) | ISOFIX CRF (F3, R3) | - | No | No | Yes F, R | - | Yes F, R |
| Booster Seat - reduced Width | ISOFIX CRF (B2) | - | No | No | Yes | No | Yes |
| Booster Seat - full Width | ISOFIX CRF (B3) | - | No | No | Yes | No | Yes |

* 1. If cushion height adjuster function is equipped, cushion should be adjusted to the highest position.

otherwise (not equipped cushion height adjuster function) seatback should be adjusted to upright position.

| Seat Number Position in the vehicle | |
|-------------------------------------|----------------|
| 1 | Front right |
| 2 | Front centre |
| 3 | Front left |
| 4 | 2nd row left |
| 5 | 2nd row centre |
| 6 | 2nd row right |



ONQ5E021068R

- * If the vehicle headrest prevents proper installation of a CRS, the headrest of the seating position shall be readjusted or entirely removed
- * Never place a rearward facing Child Restraint System on the front passenger seat, unless the air bag is deactivated.

Suitability of each seating position for belted & ISOFIX Child Restraint Systems (CRS) according to UN regulations

(Information for use by vehicle users and CRS manufacturers)

- Yes : Suitable for fitment of the designated category of CRS
- No : Not suitable for fitment of the designated category of CRS
- “-” : Not applicable

F: Forward facing

R: Rearward facing

| CRS categories | | Seating positions | | | | | |
|---|---------------------------------|-------------------|-----------------------------|--------------------------------|-------------|--------------------|-------------|
| | | 1, 2 | 3 | | 4 | 5 (2Point Belt) | 6 |
| | | | Airbag ON (or Activated) | Airbag Off (or Deactivated) | | | |
| Universal belted CRS | All mass groups | - | No | Yes ^{*1} F, R | Yes F, R | Yes F | Yes F, R |
| i-size CRS (If i-size symbol is not applied, No) | ISOFIX CRF (F2, F2X, R1, R2) | - | No | No | Yes F, R | - | Yes F, R |
| Carry-cot (ISOFIX lateral facing CRS) | ISOFIX CRF (L1, L2) | - | No | No | No | - | No |
| ISOFIX infant* CRS (* : ISOFIX baby CRS) | ISOFIX CRF (R1) | - | No | No | Yes R | - | Yes R |
| ISOFIX toddler CRS - small | ISOFIX CRF (F2,F2X, R2,R2X) | - | No | No | Yes F, R | - | Yes F, R |
| ISOFIX toddler CRS - large* (*: not booster seats) | ISOFIX CRF (F3, R3) | - | No | No | Yes F, R | - | Yes F, R |
| Booster Seat - reduced Width | ISOFIX CRF (B2) | - | No | No | Yes | No | Yes |
| Booster Seat - full Width | ISOFIX CRF (B3) | - | No | No | Yes | No | Yes |

* 1. If cushion height adjuster function is equipped, cushion should be adjusted to the highest position.

otherwise (not equipped cushion height adjuster function) seatback should be adjusted to upright position.

| Seat Number Position in the vehicle | |
|-------------------------------------|----------------|
| 1 | Front right |
| 2 | Front centre |
| 3 | Front left |
| 4 | 2nd row left |
| 5 | 2nd row centre |
| 6 | 2nd row right |



ONQ5E021068R

* If the vehicle headrest prevents proper installation of a CRS, the headrest of the seating position shall be readjusted or entirely removed

* Never place a rearward facing Child Restraint System on the front passenger seat, unless the air bag is deactivated.

Recommended CRS for Vehicle according to UN regulations (For Latin America)

(Information for use by vehicle users and CRS manufacturers)

| Mass Group | Name | Manufacturer | Type of Fixation | ECE-R44 Approval No. |
|--------------------|---------------|--------------|---|----------------------|
| Group 0+//I/II/III | JOIE SPIN 360 | JOIE | ISOFIX & Leg Support Type (Rear & Forward-Facing) | E11 - 041621 |

CRS Manufacturer information

JOIE: www.joiebaby.com

Air bag - supplemental restraint system



ONQ5021015R

* The actual features in your vehicle may not necessarily be available due to the selected options or regions.

1. Driver's front air bag
2. Passenger's front air bag
3. Side air bag*
4. Curtain air bag*
5. Front centre side air bag*

* : if equipped

⚠ WARNING

- Even in vehicles with air bags, you and your passengers must always wear the safety belts provided in order to minimise the risk and severity of injury in the event of a collision or in most rollover situations.
- SRS and pre-tensioners contain explosive chemicals. If scraping a vehicle without removing SRS and pre-tensioners from a vehicle, it may cause fire. Before scraping a vehicle, contact a professional workshop. Kia recommends to visit an authorised Kia dealer/service partner.
- Keep the SRS parts and wirings away from water or any liquid. If the SRS components are inoperative due to exposure to water or liquids, it may cause fire or severe injury.

How does the air bag system operate?

- Air bags are activated (able to inflate if necessary) only when the vehicle is in the ON position and it can be activated within about 3 minutes after ignition off.
- Air bags inflate instantly in the event of serious frontal or side collision (if equipped with side air bag or curtain air bag) in order to help protect the occupants from serious physical injury.
- There is no single speed at which the air bags will inflate. Generally, air bags are designed to inflate based upon the severity of a collision and its direction. These two factors determine whether the sensors produce an electronic deployment/ inflation signal.

- Air bags will inflate based upon the severity of a collision and its direction, etc. Air bags will not inflate in every crash or collision situation.
- The front air bags will completely inflate and deflate in an instant. It is virtually impossible for you to see the air bags inflate during an accident. It is much more likely that you will simply see the deflated air bags hanging out of their storage compartments after the collision.
- In order to help provide protection in a severe collision, the air bags must inflate rapidly. The speed of air bag inflation is a consequence of extremely short time in which a collision occurs and the need to get the air bag between the occupant and the vehicle structures before the occupant impacts those structures. This speed of inflation reduces the risk of serious or life-threatening injuries in a severe collision and is thus a necessary part of air bag design.
- However, air bag inflation can also cause injuries which can include facial abrasions, bruises and broken bones because the inflation speed also causes the air bags to expand with a great deal of force.
- There are even circumstances under which contact with the steering wheel air bag can cause fatal injuries, especially if the occupant is positioned excessively close to the steering wheel.

⚠ WARNING

- To avoid severe personal injury or death caused by deploying air bags in a collision, the driver should sit as far back from the steering wheel air bag. The front passenger should always

move their seat as far back as possible and sit back in their seat.

- Air bag inflates instantly in an event of a collision, passengers may be injured by the air bag expansion force if they are not in a proper position.
- Air bag inflation may cause injuries including facial or bodily abrasions, injuries from broken glasses or burns.

* NOTICE

If equipped with rollover sensor

Also, the air bags inflate instantly in the event of a rollover (if equipped with a side air bag or curtain air bag) in order to help protect the occupants from serious physical injury.

Noise and smoke

When the air bags inflate, they make a loud noise and they leave smoke and powder in the air inside of the vehicle. This is normal and is a result of the ignition of the air bag inflator. After the air bag inflates, you may feel substantial discomfort in breathing due to the contact of your chest with both the seat belt and the air bag, as well as from breathing the smoke and powder.

Open your doors and/or windows as soon as possible after impact in order to reduce discomfort and prevent prolonged exposure to the smoke and powder.

Though smoke and powder are non-toxic, it may cause irritation to the skin (eyes, nose and throat, etc.). If this is the case, wash and rinse with cold water immediately and consult the doctor if the symptom persists.

⚠ WARNING

- When the air bags deploy, the air bag related parts in the steering wheel and/or instrument panel and/or in both sides of the roof rails above the front and rear doors are very hot. To prevent injury, do not touch the air bag storage areas internal components immediately after an air bag has inflated.
- Do not install or place any accessories near air bag deployment areas, such as the instrument panel, windows, pillars, and roof rails.

Air bag warning and indicator light

Air bag warning light

Operating condition(s)

- When the engine is running, the warning light should appear for approximately 3~6 seconds, and go off.

Malfunction

- The light does not turn on briefly when the engine is running.
- The light stays on after illuminating for approximately 3~6 seconds.
- The light comes on whilst the vehicle is in motion.
- The light blinks when the engine is running.

Passenger's front air bag ON/OFF switch (if equipped)

The passenger's front air bag can be deactivated by the passenger's front air bag ON/OFF switch if a child restraint is installed on the front passenger's seat or if the front passenger's seat is unoccupied by a person.



Front passenger air bag ON/OFF indicator



Operating condition(s)

- After the vehicle is running
 - The Front passenger air bag ON/OFF indicator illuminates for approximately 4 seconds.
- When the passenger's front air bag ON/OFF switch is set to the ON/OFF position
 - The Front passenger air bag ON/OFF indicator is illuminated.

Operation

- Insert master key into the passenger's front air bag ON/OFF switch
- Turn the key to activate/deactivate passenger's front air bag.
 - When the child restraint is installed on the front passenger's seat.
 - When the seat is unoccupied.

* INFORMATION

To ensure the safety of your child, the passenger's front air bag must be deactivated when it should be necessary to install a rearward facing child seat on the front passenger seat in exceptional circumstances.

Non-operating condition(s)

- When the vehicle is running within approximately 3 minutes after the vehicle is turned off
 - The front air bag ON/OFF indicator will not illuminate.

⚠ WARNING

- The front air bag ON/OFF switch could turn by using a similar small rigid device. Always check the status of the front air bag ON/OFF switch and Front passenger air bag ON/OFF indicator.
- The driver is responsible for the proper position of the passenger's front air bag ON/OFF switch.
- Deactivate the passenger's front air bag only when the EV button is in OFF position, or the malfunction may occur in the SRS Control Module.

And there may be a danger that the driver's and/or front passenger's and/or side and curtain air bag may fail to trigger, or not trigger correctly during a collision.

- Never install a rearward facing child seat on the front passenger's seat unless the passenger's front air bag has been deactivated. The infant or child could be severely injured or killed by an air bag deployment in case of an accident.
- Even though your vehicle is equipped with the passenger's front air bag ON/OFF switch, do not install a child restraint system in the front passenger's seat. A child restraint system must never be placed in the front seat. Children who are too large for child restraint systems should always occupy the rear seat and use the available lap/shoulder belts. In the event of an accident, children are afforded the most safety when they are restrained by a proper restraint system in the rear seat.
- As soon as the child seat is no longer needed on the front passenger's seat, reactivate the front passenger's air bag.
- Never place or insert any object into any small opening near side airbag labels attached to the vehicle seats. When the air bag deploys, the object may affect the deployment and result in unexpected accident or bodily harm.
- No objects (such as instrument panel cover, cellular phone holder, cup holder, perfume or stickers) should be placed over or near the air bag modules on the steering wheel, instrument cluster, windscreen glass, and the front passenger's panel above the

glove box. Such objects could cause harm if the vehicle is in a crash severe enough to cause the air bags to deploy. Do not place any objects over the air bag or between the air bag and yourself.

CAUTION

- If the passenger's front air bag ON/OFF switch is not working properly, the air bag warning light on the instrument panel will illuminate. And, the passenger's front air bag OFF indicator (🚫) will not illuminate (The passenger's front air bag ON indicator comes on), the SRS Control Module reactivate the passenger's front air bag and the passenger's front air bag will inflate in frontal impact crashes even if the passenger's front air bag ON/OFF switch is set to the OFF position (🚫). In this case, have the system inspected by a professional workshop. Kia recommends visiting an authorised Kia dealer/service partner.
- If the SRS air bag warning light blinks or does not appear when the EV button is in ON position, or if it illuminates whilst the vehicle is being driven, have the system inspected by a professional workshop. Kia recommends visiting an authorised Kia dealer/service partner.

NOTE

- When the passenger's front air bag ON/OFF switch is set to the ON position, the passenger's front air bag is activated and child or infant seat should not be installed on the front passenger's seat.
- When the passenger's front air bag ON/OFF switch is set to the OFF posi-

tion, the passenger's front air bag is deactivated.

SRS components and functions

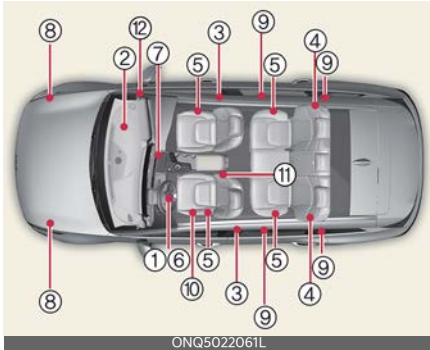

* The actual features in your vehicle may not necessarily be available due to the selected options or regions.

1. Driver's front air bag module
2. Passenger's front air bag module
3. Side air bag modules*
4. Curtain air bag modules*
5. Retractor pre-tensioner assemblies*
6. Air bag warning light
7. SRS control module (SRSCM)/rollover sensor*
8. Front impact sensors
9. Side impact sensors*
10. Side pressure sensors*
11. Driver's centre air bag module*
12. Passenger's front air bag ON/OFF switch*

* : if equipped

Operating condition(s)

- After the engine is running, the SRS air bag warning light on the instrument panel will appear for approximately 6 seconds.

The SRS air bag warning light on the instrument panel will appear for about 6 seconds after the vehicle is in the ON position, after which the air bag warning light should go out.

⚠ WARNING

If any of the following conditions occurs, this indicates a malfunction of the SRS. In this case, have the system inspected by a professional workshop. Kia recommends to visit an authorised Kia dealer/ service partner.

- The light does not turn on briefly when you turn the vehicle ON.
- The light stays on after illuminating for approximately 6 seconds.
- The light comes on whilst the vehicle is in motion.
- The light blinks when the vehicle is in ON position.

Driver's front air bag (1)



Driver's front air bag (2)



Driver's front air bag (3)



Passenger's front air bag



The air bag modules are located both in the centre of the steering wheel and in the front passenger's panel above the glove box. When the SRSCM detects a sufficiently severe impact to the front of the vehicle, it will automatically deploy the front air bags.

Upon deployment, tear seams molded directly into the pad covers will separate under pressure from the expansion of the air bags. Further opening of the covers then allows full inflation of the air bags.

A fully inflated air bag, in combination with a properly worn seat belt, slows the driver's or the passenger's forward motion, reducing the risk of head and chest injury.

After complete inflation, the air bag immediately starts deflating, enabling the driver to maintain forward visibility and the ability to steer or operate other controls.

⚠ WARNING

- Do not install or place any accessories (drink holder, CD holder, sticker, etc.) on the front passenger's panel above

the glove box in a vehicle with a passenger's air bag. Such objects may become dangerous projectiles and cause injury if the passenger's air bag inflates.

- When installing a container of liquid air freshener inside the vehicle, do not place it near the instrument cluster nor on the instrument panel surface. It may become dangerous projectiles and cause injury if the passenger's air bag inflates.
- If an air bag deploys, there may be a loud noise followed by a fine dust released in the vehicle. These conditions are normal and are not hazardous - the air bags are packed in this fine powder. The dust generated during air bag deployment may cause skin or eye irritation as well as aggravate asthma for some persons. Always wash all exposed skin areas thoroughly with cold water and a mild soap after an accident in which the air bags were deployed.
- The SRS can function only when the vehicle is in the ON position. If the SRS air bag warning light does not appear, or continuously remains on after illuminating for about 6 seconds when the vehicle is in the ON position, or after the engine is started, comes on whilst driving, the SRS is not working properly. In this case, have the system inspected by a professional workshop. Kia recommends to visit an authorised Kia dealer/service partner.
- Before you replace a fuse or disconnect a battery terminal, turn the ignition switch to the LOCK position and remove the ignition key or turn off the ENGINE START/STOP button. Never remove or replace the air bag related fuse(s) when the vehicle is in the ON

position. Failure to heed this warning will cause the SRS air bag warning light to appear.

Driver's and passenger's front air bag



The indications of the system's presence are the letters "AIR BAG" intagliated on the air bag pad cover in the steering wheel and the passenger's side front panel pad above the glove box.

⚠ WARNING

- The driver's hands should be placed on the steering wheel at the 9:00 and 3:00 positions. The passenger's arms and hands should be placed on their laps.
- Always use seat belts and child restraints - every trip, every time, everyone! Air bags inflate with considerable force and in the blink of an eye. Seat belts help keep occupants in proper position to obtain maximum benefit from the air bag. Even with air bags, improperly and unbelted occupants can be severely injured when the air bag inflates. Always follow the precautions about seat belts, air bags and occupant safety contained in this manual.
- To reduce the chance of serious or fatal injuries and receive the maximum safety benefit from your restraint system:
 - Never place a child in any child or booster seat in the front seat.
 - ABC - Always Buckle Children in the back seat. It is the safest place for children of any age to ride.
 - Front and side air bags can injure occupants improperly positioned in the front seats.
 - Move your seat as far back as practical from the front air bags, whilst still maintaining control of the vehicle.
 - You and your passengers should never sit or lean unnecessarily close to the air bags. Improperly positioned drivers and passengers can be severely injured by inflating air bags.
 - Never lean against the door or centre console - always sit in an upright position.
 - No objects should be placed over or near the air bag modules on the steering wheel, instrument panel, and the front passenger's panel above the glove box, because any such object could cause harm if the vehicle is in a crash severe enough to cause the air bags to deploy.
 - Do not tamper with or disconnect SRS wiring or other components of the SRS system. Doing so could result in injury, due to accidental deployment of the air bags or by rendering the SRS inoperative.
 - If the SRS air bag warning light remains illuminated whilst the vehicle is being driven, have the system inspected by a professional workshop. Kia recommends to visit an authorised Kia dealer/service partner.

- Air bags can only be used once - have the system replaced by a professional workshop.
Kia recommends to visit an authorised Kia dealer/service partner.
- The SRS is designed to deploy the front air bags only when an impact is sufficiently severe and when the impact angle is less than 30° from the forward longitudinal axis of the vehicle. Additionally, the air bags will only deploy once. Seat belts must be worn at all times.
- Front air bags are not intended to deploy in side-impact, rear-impact or rollover crashes. In addition, front air bags will not deploy in frontal crashes below the deployment threshold.
- A child restraint system must never be placed in the front seat. The infant or child could be severely injured or killed by an air bag deployment in case of an accident.
- Children age 13 and under must always be properly restrained in the rear seat. Never allow children to ride in the front passenger seat. If a child over age 13 must be seated in the front seat, he or she must be properly belted and the seat should be moved as far back as possible.
- For maximum safety protection in all types of crashes, all occupants including the driver should always wear their seat belts whether or not an air bag is also provided at their seating position to minimise the risk of severe injury or death in the event of a crash. Do not sit or lean unnecessarily close to the air bag whilst the vehicle is in motion.
- Sitting improperly or out of position can result in serious or fatal injury in a crash. All occupants should sit upright with the seat back in an upright position, centre on the seat cushion with their seat belt on, legs comfortably extended and their feet on the floor until the vehicle is parked and the ignition key is removed.
- The SRS air bag system must deploy very rapidly to provide protection in a crash. If an occupant is out of position because of not wearing a seat belt, the air bag may forcefully contact the occupant causing serious or fatal injuries.
- No objects (such as instrument panel cover, cellular phone holder, cup holder, perfume or stickers) should be placed over or near the air bag modules on the steering wheel, instrument panel, windscreen glass, and the front passenger's panel above the glove box. Such objects could cause harm if the vehicle is in a crash severe enough to cause the air bags to deploy. Do not place any objects over the air bag or between the air bag and yourself.

Side air bag and front centre air bag (if equipped)

Your vehicle is equipped with a side air bag in each front seat.



* The actual air bags in the vehicle may differ from the illustration.

The purpose of the air bag is to provide the vehicle's driver and/or the front passenger with additional protection than that offered by the seat belt alone.

The side air bags are designed to deploy only during certain side-impact collisions, depending on the crash severity, angle, speed and point of impact. The side air bags are not designed to deploy in all side impact situations.

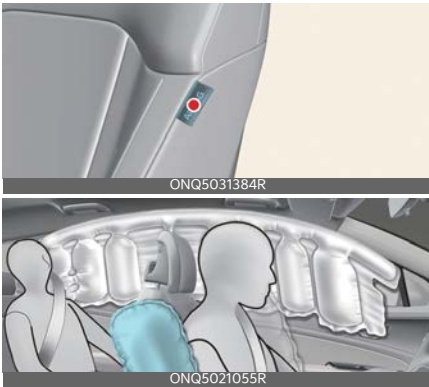

* The actual air bags in the vehicle may differ from the illustration.

⚠ WARNING

- Do not allow the passengers to lean their heads or bodies onto doors, put their arms on the doors, stretch their arms out of the window, or place objects between the doors and passengers when they are seated on seats equipped with side and/or curtain air bags.
- The side air bags are supplemental to the driver's and the passenger's seat belt systems and is not a substitute for them. Therefore your seat belts must be worn at all times whilst the vehicle is in motion. The air bags

deploy only in certain side impact or rollover conditions (Only vehicle equipped with rollover sensor) severe enough to cause significant injury to the vehicle occupants.

- For best protection from the side air bag system and to avoid being injured by the deploying side air bag, both front seat occupants should sit in an upright position with the seat belt properly fastened.
- Do not use any accessory seat covers.
- Use of seat covers could reduce or prevent the effectiveness of the system.
- To prevent unexpected deployment of the side air bag that may result in personal injury, avoid impact to the side impact sensor when the vehicle is in ON position.
- If the seat or seat cover is damaged, have the system serviced by a professional workshop.
Kia recommends to visit an authorised Kia dealer/service partner.
- Do not place any objects over the air bag or between the air bag and yourself. Also, do not attach any objects around the area the air bag inflates such as the door, side door glass, front and rear pillar.
- Do not place any objects between the door and the seat. They may become dangerous projectiles if the side air bag inflates.
- Do not install any accessories on the side or near the side air bags.

*** NOTICE**

If equipped with rollover sensor

Also, the air bags inflate instantly in the event of a rollover (if equipped with a

side air bag or curtain air bag) in order to help protect the occupants from serious physical injury.

Curtain air bag (if equipped)



* The actual air bags in the vehicle may differ from the illustration.

Curtain air bags are located along both sides of the roof rails above the front and rear doors.

They are designed to help protect the heads of the front seat occupants and the rear seat occupants in certain side impact collisions.

The curtain air bags are designed to deploy during certain side impact collisions, depending on the crash severity, angle, speed and point of impact. The curtain air bags are not designed to deploy in all side impact situations, collisions from the front or rear of the vehicle or in most rollover situations.

⚠ WARNING

- Failure to follow the instructions mentioned can result in injury or death to the vehicle occupants in an accident.
 - Do not hang heavy items on the coat hooks for safety reasons.

- In order for side and curtain air bags to provide the best protection, both front seat occupants and both outboard rear occupants should sit in an upright position with the seat belts properly fastened.

Importantly, children should sit in a proper child restraint system in the rear seat.

- When children are seated in the rear outboard seats, they must be seated in the proper child restraint system.

Make sure to put the child restraint system as far away from the door side as possible, and secure the child restraint system in a locked position.

- Do not allow the passengers to lean their heads or bodies onto doors, put their arms on the doors, stretch their arms out of the window, or place objects between the doors and passengers when they are seated on seats equipped with side and/or curtain air bags.
- Never try to open or repair any components of the curtain air bag system. If necessary, have the system serviced by a professional workshop. Kia recommends to visit an authorised Kia dealer/service partner.
- Do not place any objects over the air bag. Also, do not attach any objects around the area the air bag inflates such as the door, side door glass, front and rear pillar, roof side rail.
- Do not hang hard or breakable objects on the clothes hanger.

*** NOTICE**

If equipped with rollover sensor

Also, the air bags inflate instantly in the event of a rollover (if equipped with a side air bag or curtain air bag) in order to help protect the occupants from serious physical injury.

Air bag collision sensors



* The actual features in your vehicle may not necessarily be available due to the selected options or regions.

- 1 Supplemental Restraint System (SRS) control module/rollover sensor
- 2 Front impact sensor
- 3 Side pressure sensors (front door)*
- 4 Side impact sensor (B-pillar)*
- 5 Side impact sensor (C-pillar)*



* : if equipped

⚠ WARNING

- Do not hit or allow any objects to impact the locations where air bag or sensors are installed.
This may cause unexpected air bag deployment, which could result in serious personal injury or death.
- If the installation location or angle of the sensors is altered in any way, the air bags may deploy when they should not or they may not deploy when they should, causing severe injury or death.
Therefore, do not try to perform maintenance on or around the air bag sensors. Have the system serviced by a professional workshop. Kia recommends to visit an authorised Kia dealer/service partner.
- Problems may arise if the sensor installation angles are changed due to the deformation of the front bumper, body or B pillar where side collision sensors are installed. In this case, have the system serviced by a professional workshop. Kia recommends to visit an authorised Kia dealer/ service partner.
- Your vehicle has been designed to absorb impact and deploy the air bag(s) in certain collisions. Use only Kia Genuine Parts or those of an equivalent standard to install bumper guards or replace a bumper. If not, it may adversely affect your vehicle's collision and air bag deployment performance.
- **If equipped with rollover sensor**
If your vehicle is equipped with side and curtain air bag, set the ignition switch or ENGINE START/STOP button to OFF or ACC position and wait

for 3 minutes when the vehicle is being towed.
The side and curtain air bag may deploy when the ignitions is ON or the ignition is OFF within 3 minutes, and the rollover sensor detects the situation as a rollover.

Air bag inflation conditions

| Air bag inflation conditions | |
|--|---|
|  <p>ONQ5021024</p> | <p>Front air bags are designed to inflate in a frontal collision depending on the intensity, speed or angles of impact of the front collision.</p> |
|  <p>ONQ5021071R</p> | <p>Side and/or curtain air bags are designed to inflate when an impact is detected by side collision sensors depending on the strength, speed or angles of impact resulting from a side impact collision.</p> |

*** INFORMATION**

- **Side and curtain air bags (if equipped)**
Also, the side and curtain air bags are designed to inflate when a rollover is detected by a rollover sensor.
Although the front air bags (driver's and front passenger's air bags) are designed to inflate only in frontal collisions, they also may inflate in other types of collisions if the front impact sensors detect a sufficient impact. Side air bags (side and/or curtain air bags) are designed to inflate only in side impact collisions, but they may inflate in other collisions if the side impact sensors detect a sufficient impact.
For instance, side airbag and curtain air bags may inflate if rollover sensors indicate the possibility of a rollover occurring (even if none actually

occurs) or in other situations, including when the vehicle is tilted whilst being towed. Even if side and/or curtain air bags do not provide impact protection in a rollover, they will deploy to prevent ejection of occupants, especially those who are restrained with seat belts.

If the vehicle chassis is impacted by bumps or objects on unimproved roads or sidewalks, air bags may deploy. Drive carefully on unimproved roads or on surfaces not designed for vehicle traffic to prevent unintended air bag deployment.





*** NOTICE**

If equipped with rollover sensor

Also, the side and curtain air bags are designed to inflate when a rollover is detected by a rollover sensor.

Air bag non-inflation conditions

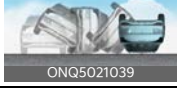
| Air bag non-inflation conditions | |
|---|--|
|  ONQ5021024 | In certain low-speed collisions the air bags may not deploy. |
|  ONQ5021026 | Air bags are not designed to inflate in rear collisions. |
|  ONQ5021027 | Heavy braking lowers the front portion of the vehicle causing it to "ride" under a vehicle with a higher ground clearance. Air bags may not inflate in this "under-ride" situation because deceleration forces that are detected by sensors may be significantly reduced by such "under-ride" collisions. |

| Air bag non-inflation conditions | |
|---|---|
|  ONQ5021038 | In an angled collision, the force of impact may send the occupants in a direction where the air bags would not be able to provide any additional benefit; thus, the sensors may not deploy any air bags. |
|  ONQ5021025 | Front air bags may not inflate in side impact collisions. However, if equipped with side and curtain air bags, the air bags may inflate depending on the intensity, vehicle speed and angles of impact. |
|  ONQ5021039 | Air bags may not inflate in rollover accidents because the vehicle cannot detect the rollover. |
|  ONQ5021028 | Air bags may not inflate if the vehicle collides with objects such as utility poles or trees, meaning the point of impact is concentrated in one area and the full force of the impact is not delivered to the sensors. |

⚠ WARNING

- The SRS is designed to deploy the front air bags only when an impact is sufficiently severe and when the impact angle is less than 30° from the forward longitudinal axis of the vehicle.
- Front air bags are not intended to deploy in side-impact, rear-impact or rollover crashes. In addition, front air bags will not deploy in frontal crashes below the deployment threshold.
- The air bags deploy only in certain side impact or rollover conditions (Only vehicle equipped with rollover sensor) severe enough to cause significant injury to the vehicle occupants.
- If your vehicle is equipped with side and curtain air bag, set the ignition switch or ENGINE START/STOP button to OFF or ACC position and wait for 3 minutes when the vehicle is

being towed. This side and curtain air bag may deploy when the ignitions is ON or the ignition is OFF within 3 minutes, and the rollover sensor detects the situation as a rollover.

- Deactivate the passenger's front air bag only when the ignition switch or ENGINE START/STOP button is switched off, or the malfunction may occur in the SRS Control Module. And there may be a danger that the driver's and/or front passenger's and/or side and curtain air bag may fail to trigger, or not trigger correctly during a collision.
- Do not hit or allow any objects to impact the locations where air bag or sensors are installed. This may cause unexpected air bag deployment, which could result in serious personal injury or death.
- If the installation location or angle of the sensors is altered in any way, the air bags may deploy when they should not or they may not deploy when they should, causing severe injury or death. Therefore, do not try to perform maintenance on or around the air bag sensors. Have the system serviced by a professional workshop. Kia recommends to visit an authorised Kia dealer/service partner.
- Your vehicle has been designed to absorb impact and deploy the air bag(s) in certain collisions. Use only Kia Genuine Parts or those of an equivalent standard to install bumper guards or replace a bumper. If not, it may adversely affect your vehicle's collision and air bag deployment performance.
- If an air bag deploys, there may be a loud noise followed by a fine dust

released in the vehicle. These conditions are not hazardous.

- The air bags are packed in this fine power. The dust generated during air bag deployment It may cause skin or eye irritation as well as aggravate asthma for some persons. Always wash all exposed skin areas thoroughly with cold water and a mild soap after an accident in which the air bags were deployed.
- For cleaning the air bag pad covers, use only a soft, dry cloth or one which has been moistened with plain water.
- Solvents or cleaners could adversely affect the air bag covers and proper deployment of the system.
- Keep the SRS parts and wirings away from water or any liquid. If the SRS components are inoperative due to exposure to water or liquids, it may cause fire or severe injury.
- If any of the following conditions occurs, this indicates a malfunction of the SRS. In this case, have the system inspected by a professional workshop. Kia recommends to visit an authorised Kia dealer/service partner.
 - The light does not turn on briefly when you turn the ignition ON.
 - The light stays on after illuminating for approximately 6 seconds.
 - The light comes on whilst the vehicle is in motion.
 - The light blinks when the ignition switch or ENGINE START/STOP button is in ON position.
- Before you replace a fuse or disconnect a battery terminal, turn the ignition switch or ENGINE START/STOP button to the LOCK position and remove the ignition key or turn off the ENGINE START/STOP button. Never

remove or replace the air bag related fuse(s) when the ignition switch or ENGINE START/STOP button is in the ON position. Failure to heed this warning will cause the SRS air bag warning light to appear.

- Do not tamper with or disconnect wiring or other components of the SRS system, including the addition of any kind of badges to the pad covers or modifications to the body structure. Doing so could adversely affect SRS performance and lead to possible injury. If necessary, have the system serviced by a professional workshop. Kia recommends to visit an authorised Kia dealer/service partner.
- If your car was flooded and has soaked carpeting or water on flooring, you shouldn't try to start the engine; in this case, have your vehicle inspected by a professional workshop. Kia recommends to contact an authorised Kia dealer/service partner.
- Air bags can only be used once. If the air bags inflate, have the system replaced by a professional workshop. Kia recommends to visit an authorised Kia dealer/service partner.
- If components of the air bag system must be discarded, or if the vehicle must be scrapped, certain safety precautions must be observed, such as removing SRS and pre-tensioners from a vehicle due to the risk of fire. Failure to follow these precautions and procedures could increase the risk of personal injury. An authorised Kia dealer knows these precautions and can give you the necessary information.

* NOTICE

• If equipped with rollover sensor

The side and curtain air bags are designed to inflate when a rollover is detected by a rollover sensor. The air bags may inflate in a rollover, when it is detected by the rollover sensor.

• If equipped without rollover sensor

However, side and/or curtain air bags may inflate when the vehicle is rolled over by a side impact collision, if the vehicle is equipped with side air bags and curtain air bags.

SRS care

The SRS is virtually maintenance-free and so there are no parts you can safely service by yourself.

If the SRS air bag warning light does not appear, or continuously remains on, have the system inspected by a professional workshop. Kia recommends to visit an authorised Kia dealer/service partner.

⚠ WARNING

- Modification to SRS components or wiring, including the addition of any kind of badges to the pad covers or modifications to the body structure, can adversely affect SRS performance and lead to possible injury.
- For cleaning the air bag pad covers, use only a soft, dry cloth or one which has been moistened with plain water. Solvents or cleaners could adversely affect the air bag covers and proper deployment of the system.
- No objects should be placed over or near the air bag modules on the steering wheel, instrument panel, and the front passenger's panel above the

glove box, because any such object could cause harm if the vehicle is in a crash severe enough to cause the air bags to inflate.

- If the air bags inflate, have the system replaced by a professional workshop. Kia recommends to visit an authorised Kia dealer/service partner.
- Do not tamper with or disconnect SRS wiring, or other components of the SRS system. Doing so could result in injury, due to accidental inflation of the air bags or by rendering the SRS inoperative.
- If components of the air bag system must be discarded, or if the vehicle must be scrapped, certain safety precautions must be observed. An authorised Kia dealer knows these precautions and can give you the necessary information. Failure to follow these precautions and procedures could increase the risk of personal injury.
- If your car was flooded and has soaked carpeting or water on flooring, you shouldn't try to start the engine; in this case, have your vehicle inspected by a professional workshop. Kia recommends to contact an authorised Kia dealer/service partner.

Additional safety precautions

- **Never let passengers ride in the cargo area or on top of a folded-down back seat.** All occupants should sit upright, fully back in their seats with their seat belts on and their feet on the floor.
- **Passengers should not move out of or change seats whilst the vehicle is moving.** A passenger who is not wearing a seat belt during a crash or emergency stop can be thrown against the inside of the vehicle, against other occupants, or out of the vehicle.
- **Each seat belt is designed to restrain one occupant.** If more than one person uses the same seat belt, they could be seriously injured or killed in a collision.
- **Do not use any accessories on seat belts.** Devices claiming to improve occupant comfort or reposition the seat belt can reduce the protection provided by the seat belt and increase the chance of serious injury in a crash.
- **Passengers should not place hard or sharp objects between themselves and the air bags.** Carrying hard or sharp objects on your lap or in your mouth can result in injuries if an air bag inflates.
- **Keep occupants away from the air bag covers.** All occupants should sit upright, fully back in their seats with their seat belts on and their feet on the floor. If occupants are too close to the air bag covers, they could be injured if the air bags inflate.
- **Do not attach or place objects on or near the air bag covers.** Any object attached to or placed on the front or side air bag covers could interfere with the proper operation of the air bags.
- **Do not modify the front seats.** Modification of the front seats could interfere with the operation of the supplemental restraint system sensing components or side air bags.
- **Do not place items under the front seats.** Placing items under the front seats could interfere with the operation of the supplemental restraint system.

tem sensing components and wiring harnesses.

- **Never hold an infant or child on your lap.** The infant or child could be seriously injured or killed in the event of a crash. All infants and children should be properly restrained in appropriate child safety seats or seat belts in the rear seat.

⚠ WARNING

- Sitting improperly or out of position can cause occupants to be shifted too close to a deploying air bag, strike the interior structure or be thrown from the vehicle resulting in serious injury or death.
- Always sit upright with the seatback in an upright position, centred on the seat cushion with your seat belt on, legs comfortably extended and your feet on the floor.

Adding equipment to or modifying your air bag-equipped vehicle

If you modify your vehicle by changing your vehicle's frame, bumper system, front end or side sheet metal or ride height, this may affect the operation of your vehicle's air bag system.

Air bag warning labels



Air bag warning label



Air bag warning labels are attached to alert the passengers of potential risk of air bag system. Be sure to read all of the information about the air bags that are installed on your vehicle in this Owners Manual. Note that these government warnings focus on the risk of children. We also want you to be aware of the risks adult are exposed to which have been described in previous pages. If equipped with the air bags mentioned below, additional warning labels are attached on each air bag modules and inflators. Read the below warning to be aware of the potential risks of the air bag system.

⚠ WARNING

- Never place a rear facing child restraint in the front passenger seat, unless the passenger-side air bag is deactivated. An inflating passenger-side air bag could impact the rear-facing child restraint and kill the child.
- Extreme Hazard! Do not use a rearward facing child restraint on a seat protected by an airbag in front of it!

- Never put a child restraint in the front passenger's seat. If the front passenger air bag inflates, it can cause serious or fatal injuries.
- NEVER use a rearward facing child restraint on a seat protected by an ACTIVE AIR BAG in front of it. DEATH or SERIOUS INJURY to the CHILD can occur.
- When children are seated in the rear outboard seats of a vehicle equipped with side and/or curtain air bags, be sure to install the child restraint system as far away from the door side as possible, and securely lock the child restraint system in position.
Inflation of side and/or curtain air bags could cause serious injury or death to an infant or child.

*** NOTICE**

If equipped with rollover sensor

- The air bags inflate instantly in the event of a rollover (if equipped with a side air bag or curtain air bag) in order to help protect the occupants from serious physical injury.
 - The side and/or the curtain air bag may deploy when the rollover sensor detects the situation as a rollover.
-

| | |
|---|-------------|
| Keys | 4-6 |
| • Replacing the key battery | 4-6 |
| • Using the remote key | 4-7 |
| • Using the smart key | 4-8 |
| Immobiliser system | 4-10 |
| • Vehicles with the remote key | 4-10 |
| • Vehicles with the smart key | 4-10 |
| Theft-alarm system | 4-11 |
| • Armed stage | 4-11 |
| • Theft-alarm stage | 4-11 |
| • Disarmed stage..... | 4-12 |
| Door locks | 4-12 |
| • Door locks outside the vehicle | 4-12 |
| • Door locks inside the vehicle | 4-13 |
| • Door lock features | 4-15 |
| • Manual door lock switch | 4-15 |
| • Rear door locks | 4-16 |
| • Rear Occupant Alert (ROA) | 4-16 |
| Driver position memory system | 4-17 |
| • Setting memory position..... | 4-17 |
| • Recalling memory position | 4-17 |
| • Resetting the driver position memory system | 4-17 |
| • Easy access function | 4-17 |
| Tailgate | 4-18 |
| • Opening/closing the manual tailgate..... | 4-18 |
| Power tailgate | 4-19 |
| • Operating the power tailgate..... | 4-19 |
| • Automatic reverse..... | 4-19 |
| • Setting the power tailgate | 4-21 |
| • Resetting the power tailgate..... | 4-22 |

4 Features of your vehicle

| | |
|--|-------------|
| • Emergency tailgate safety release..... | 4-23 |
| Windows | 4-24 |
| • Controlling power windows switch | 4-25 |
| • Resetting power windows | 4-25 |
| • Power windows automatic reversal..... | 4-25 |
| • Power windows lock button | 4-26 |
| • Remote window closing/opening | 4-27 |
| Bonnet | 4-28 |
| • Opening the bonnet | 4-28 |
| • Closing the bonnet | 4-29 |
| Fuel filler door..... | 4-30 |
| • Opening the fuel filler door | 4-30 |
| • Closing the fuel filler door | 4-30 |
| Panorama sunroof | 4-32 |
| • Power sunshade..... | 4-33 |
| • Tilt open/close | 4-33 |
| • Slide open/close | 4-33 |
| • Automatic reversal | 4-34 |
| • Resetting the sunroof..... | 4-35 |
| • Sunroof open warning..... | 4-35 |
| Steering wheel | 4-36 |
| • Adjusting steering wheel angle and height..... | 4-36 |
| • Heated steering wheel..... | 4-37 |
| • Horn | 4-38 |
| Mirrors..... | 4-38 |
| • Inside rear view mirror..... | 4-38 |
| • Outside rear view mirror | 4-39 |
| Instrument cluster..... | 4-41 |
| LCD display..... | 4-45 |
| • LCD display modes | 4-46 |

| | |
|---|-------------|
| • LCD display messages..... | 4-52 |
| Vehicle settings (infotainment system)..... | 4-54 |
| Warning and indicator lights | 4-55 |
| Lighting..... | 4-60 |
| • Lighting functions..... | 4-60 |
| • Lighting controls..... | 4-61 |
| • High Beam Assist (HBA)..... | 4-63 |
| • Headlamp levelling adjustment switch | 4-66 |
| Wipers and washers | 4-66 |
| • Wipers | 4-66 |
| • Washers..... | 4-68 |
| • Heated washer nozzle..... | 4-69 |
| Welcome system | 4-69 |
| • Illuminating functions..... | 4-69 |
| Interior lights..... | 4-70 |
| • Automatic turn off function | 4-70 |
| • Map lamp..... | 4-70 |
| • Room lamp..... | 4-71 |
| • Personal lamp..... | 4-71 |
| • Luggage room lamp | 4-71 |
| • Vanity mirror lamp | 4-72 |
| • Glove box lamp..... | 4-72 |
| Climate control system | 4-72 |
| • Operating climate control system | 4-75 |
| Manual climate control system..... | 4-78 |
| • Controlling temperature/fan speed control..... | 4-79 |
| • Max A/C mode..... | 4-79 |
| Automatic climate control system..... | 4-80 |
| • Using the infotainment/climate switchable controller control panel (For Type B)..... | 4-81 |

4 Features of your vehicle

- Controlling heating and air conditioning automatically 4-81
- Controlling temperature 4-82
- Adjusting driver and passenger side temperature equally 4-83
- Changing temperature scale (For Type A (button)) 4-83
- Controlling fan speed 4-83
- Turning the fan OFF 4-83
- Climate control features 4-83
- Windscreen defrosting and defogging 4-85**
 - Defrosting/defogging windscreen 4-85
 - Auto defogging for automatic climate control 4-86
 - Rear window/outside mirror defroster 4-86
 - Resetting defogging logic 4-87
 - Front glass heater 4-87
- Storage compartment 4-88**
 - Centre console storage/glove box 4-88
 - Luggage net holder 4-88
 - Cargo security screen 4-89
- Interior features 4-90**
 - Ambient lights 4-90
 - Cup holders 4-90
 - Seat warmer/ventilation 4-90
 - Sun visor 4-91
 - USB charger/port 4-92
 - Power outlet 4-93
 - Wireless smart phone charging system 4-93
 - Coat hook 4-95
 - Side curtain 4-96
 - Floor mat anchors 4-96
- Exterior features 4-97**
 - Roof rack 4-97

Infotainment system 4-98

- Using the infotainment/climate switchable controller..... 4-98

Features of your vehicle

* The information provided may differ according to which functions are applicable to your vehicle.

Keys

⚠ WARNING

Never leave the keys in your vehicle

Leaving children unattended in a vehicle with the keys is dangerous even if the vehicle is ACC or ON position.

Unattended children could place the key in the ignition switch or press the ENGINE START/STOP button and may operate power windows or other controls, or even make the vehicle move, which could result in **SERIOUS BODILY INJURY OR EVEN DEATH**. Never leave the keys in your vehicle with unsupervised children, when the engine is running.

Record your key number

The key code number is stamped on the key code tag attached to the key set.

If you lose your keys, Kia recommends to contact an authorised Kia dealer/service partner.

Remove the key code tag and store it in a safe place. Also, record the key code number and keep it in a safe place (not in the vehicle).

Replacing the key battery



Operation

1. Pry open the key cover gently.
2. Replace the old battery with a new battery.

⚠ WARNING

THIS PRODUCT CONTAINS A BUT-TON BATTERY

If swallowed, a lithium button battery can cause severe or fatal injuries within 2 hours.

Keep batteries out of reach of children.

If you think batteries may have been swallowed or placed inside any part of the body, seek immediate medical attention.

*** INFORMATION**

The battery is CR2032 (3V).

⚠ CAUTION

- The remote key or smart key is designed to give you years of trouble-free use, however it can malfunction if exposed to moisture or static electricity. If you are unsure how to use or replace the battery, Kia recommends to contact an authorised Kia dealer/service partner.
- Using the wrong battery can cause the remote key or smart key to malfunction. Be sure to use the correct battery.
- To avoid damaging the remote key or smart key, don't drop it, get it wet, or expose it to heat or sunlight.



• An inappropriately disposed battery can be harmful to the environment and human health. Dispose the

battery according to your local law(s) or regulation.

Using the remote key



- 1 Lock button
- 2 Unlock button
- 3 Tailgate unlock/open button (if equipped)
- 4 Mechanical key release button

Operation

1. Press the corresponding button.
2. Fold the mechanical key whilst pressing the mechanical key release button (4).

Non-operating condition(s)

- The mechanical key is in the ignition switch.
- Exceeding the operating distance limit (approximately 10 m [30 ft.])
- The battery in the key is weak.
- Other vehicles or objects may be blocking the signal.
- The weather is extremely cold.
- The key is close to a radio transmitter, such as a radio station or an airport which can interfere with normal operation of the remote key.

* INFORMATION

- After pressing the lock/unlock button (1, 2) on the key, the hazard warning lights will blink.

- After pressing unlock button (2), the doors will lock automatically unless you open any door within 30 seconds.
- Press and hold the tailgate unlock button (3) to unlock the tailgate. The tailgate will lock automatically once the tailgate is opened and closed.
- If any door, bonnet or tailgate remains open, the hazard warning lights will not blink.

⚠ WARNING

Kia recommends to use parts for replacement from an authorised Kia dealer/service partner. If an aftermarket key is used, the vehicle may not return to ON after START. If this happens, the starter will continue to operate causing damage to the starter motor and possible fire due to excessive current in the wiring.

⚠ CAUTION

Do not fold the key without pressing the release button. This may damage the key.

* NOTICE

- Keep the remote key away from water or any liquid and fire. If the inside of the remote key gets damp (due to drinks or moisture), or is heated, internal circuit may malfunction, excluding the car from the warranty.
- Avoid dropping or throwing the remote key.
- Protect the remote key from extreme temperatures.
- When the remote key does not work correctly, open and close the door with the mechanical key. If you have a

problem with the remote key, Kia recommends to contact an authorised Kia dealer/service partner.

- If the remote key is in close proximity to your cellular phone or smartphone, the signal from the transmitter could be blocked by normal operation of your cellular phone or smartphone. This is especially important when the phone is active such as making call, receiving calls, text messaging, and/or sending/receiving emails.
- Avoid placing the remote key and your cellular phone or smartphone in the same pants or jacket pocket and maintain adequate distance between the two devices.

Using the smart key (if equipped)



- 1 Lock button
- 2 Unlock button
- 3 Tailgate unlock/open button (if equipped)
- 4 Remote start button (if equipped)

- 5 Remote Start Parking Assist (Forward) button (if equipped)
- 6 Remote Start Parking Assist (Backward) button (if equipped)

Operation

- Press the corresponding button.

Non-operating condition(s)

- The key is close to a radio transmitter, such as a radio station or an airport which can interfere with normal operation of the smart key.
- Being near a mobile two-way radio system or a cellular phone.
- Another vehicle's smart key is being operated close to your vehicle.

* INFORMATION

- After pressing the lock/unlock button (1, 2) on the key, the hazard warning lights will blink.
- After pressing unlock button (2), the doors will lock automatically unless you open any door within 30 seconds.
- Press and hold the tailgate unlock/open button (3) to unlock or open the tailgate, according to the vehicle options. The tailgate will lock automatically once the tailgate is opened and closed.
- If any door, bonnet or tailgate remains open, the hazard warning lights will not blink.

* NOTICE

- If, for some reason, you happen to lose your smart key, you will not be able to start the vehicle. Tow the vehicle, if necessary, contact a professional workshop. Kia recommends to

contact an authorised Kia dealer/service partner.

- A maximum of 2 smart keys can be registered to a single vehicle. If you lose a smart key, Kia recommends to contact an authorised Kia dealer/service partner.
- When the smart key does not work properly, open and close the door with the mechanical key. If you have a problem with the smart key, Kia recommends to contact an authorised Kia dealer/service partner.

Starting the vehicle remotely (if equipped)

Operation

1. Lock the doors by pressing the lock button (1) within 10 m (32 ft.) distance from the vehicle.
2. Within 4 seconds after locking the doors, press and hold the remote start button (4) for over 2 seconds.
3. Press the remote start button (4) again to turn off the vehicle.

* INFORMATION

If no further action for operating/driving the vehicle is taken, the vehicle will be turned off 10 minutes after starting the vehicle remotely.

Parking the vehicle remotely (if equipped)

Operation

1. Press the Remote Start Parking Assist (Forward) button (5) on the smart key to move the vehicle forward.
2. Press the Remote Start Parking Assist (Backward) button (6) on the smart key to move the vehicle backward.

* INFORMATION

For more information, refer to "Remote Smart Parking Assist (RSPA) (if equipped)" on page 7-123.

Removing the mechanical key from the smart key



- 1 Tab
- 2 Mechanical key

Operation

1. Press and hold the tab (1).
2. Pull the mechanical key (2) out.

Immobiliser system (if equipped)

The immobiliser system reduces the risk of unauthorised vehicle use.

It is comprised of a small transponder in the ignition switch and electronic devices inside the vehicle. It checks and determines and verifies if the ignition key is valid or not.

If the key is valid, the engine will start. If the key is invalid, the engine will not start.

Vehicles with the remote key

Operation

1. To deactivate the immobiliser system, insert the mechanical key into the ignition switch and turn to the ON position.
2. To activate the immobiliser system, turn the mechanical key to the OFF position.
3. The immobiliser system activates automatically. Without a valid remote key for your vehicle, the vehicle will not start.

Vehicles with the smart key (if equipped)

Operation

1. To deactivate the immobiliser system, press the ENGINE START/STOP button to the ON position.
2. To activate the immobiliser system, press the ENGINE START/STOP button to the OFF position.
3. The immobiliser system activates automatically. Without a valid smart key for your vehicle, the vehicle will not start.

WARNING

In order to prevent theft of your vehicle, do not leave spare keys anywhere in your vehicle. Your immobiliser password is a customer unique password and should be kept confidential. Do not leave this number anywhere in your vehicle.

CAUTION

- Do not put metal accessories near the ignition switch or the ENGINE START/STOP button. Metal accessories may interrupt the transponder signal and may prevent the vehicle from being started.
- The transponder in your key is an important part of the immobiliser system. It is designed to give years of trouble-free service, however you should avoid exposure to moisture, static electricity and rough handling. Immobiliser system malfunction could occur.
- Do not change, alter or adjust the immobiliser system because it could cause the immobiliser system to malfunction. In this case, have the system serviced by a professional workshop. Kia recommends visiting an authorised Kia dealer/service partner.
- Malfunctions caused by improper alterations, adjustments or modifications to the immobiliser system are not covered by your vehicle manufacturer warranty.
- Do not attempt to alter this system or add other devices to it. Electrical problems could result that may make your vehicle inoperable.

* NOTICE

- When starting the vehicle, do not use the key with other immobiliser keys around. Otherwise, the engine may not start or may stop soon after it starts. Keep each key separately in order to avoid a starting malfunction.
- If you need additional keys or lose your keys, Kia recommends visiting an authorised Kia dealer/service partner.

Theft-alarm system (if equipped)



The system provides an audible alarm and the hazard warning lights blink if triggered. The system is operated in 3 stages.

Armed stage

Operation

1. Lock the doors by pressing the lock button on the key or door handle.
2. The hazard warning lights will blink once to indicate that the system is armed.
3. The chime will sound for approximately 3 seconds if any doors remain open.

Operating condition(s)

- 30 seconds after all doors are closed and locked.
- Mechanical key is removed from the ignition switch.
- ENGINE START/STOP button is in the OFF position.

Theft-alarm stage

Operation

1. The horn will sound.
2. The hazard warning lights will blink continuously for approximately 30 seconds.
3. Unlock the doors with the key to turn off the system.

Operating condition(s)

- Doors/tailgate/bonnet are opened without using the remote key or smart key.

Disarmed stage

Operation

1. The hazard warning lights will blink twice after the doors are unlocked.
2. After pressing the door unlock button, if any door (or tailgate) is not opened within 30 seconds, the system will be rearmed.

Operating condition(s)

- Door unlock button is pressed.
- The engine is started.
- The vehicle is in ON position for more than approximately 30 seconds. (For remote key)
- Outside door handle button is pressed. (For smart key)

⚠ CAUTION

Do not attempt to alter this system or add other devices to it. Electrical problems could result that may make your vehicle inoperable.

* NOTICE

- Avoid trying to start the engine whilst the alarm is activated. The vehicle starting motor is disabled during the theft-alarm stage.
- If the system is not disarmed with the remote key, insert the mechanical key into the ignition switch, turn the ignition switch to the ON position and wait for 30 seconds. Then the system will be disarmed.

Door locks

Door locks outside the vehicle

Locking/unlocking with the smart key



Operation

1. Press the front door handle button (driver's side)
2. Hazard warning lights will blink.
 - Locking: Once
 - Unlocking: Twice

Non-operating condition(s)

- Smart key is in the vehicle.
- The vehicle is in ACC or ON position.
- Doors (except tailgate) is opened.

* INFORMATION

The chime will sound for 3 seconds when the doors are locked.

* INFORMATION

- After pressing the button, the doors will lock automatically unless you open any door within 30 seconds.
- If you want to make sure that a door has locked or not, you should pull the driver side door handle.
- Make sure the doors are closed securely.
- If the door is locked/unlocked multiple times in rapid succession with either the vehicle key or door lock switch,

the system may stop operating temporarily in order to protect the circuit and prevent damage to system components.

- Always remove the ignition key, engage the parking brake, close all windows, and lock all doors when leaving your vehicle unattended.
- Always place the ignition switch or ENGINE START/STOP button in the OFF position, engage the parking brake, close all windows, and lock all doors when leaving your vehicle unattended.

Limitation(s)

- Smart key is detected within 0.7~1 m radius (28~40 inches).

Locking/unlocking with the mechanical key



- 1 Tab
- 2 Cover

Operation

1. Pull the driver's side door handle, holding it in place.
2. Insert the key into the tab (1).
3. Lift the cover (2).
4. Turn the key.
 - Locking: Left
 - Unlocking: Right

* NOTICE

- When locking the door with a mechanical key, be aware that only the driver's door can be locked/unlocked.
- To lock all doors, operate the central lock switch inside the vehicle. Open the car door using the inner handle, then close the door and lock the driver's door with a mechanical key.
- Refer to "Door locks inside the vehicle" on page 4-13 to lock from inside the vehicle.
- Be careful not to lose or scratch the cover when removing it.
- When the key cover freezes and does not open, tap it lightly or indirectly warm (hand temperature, etc.) it up.
- Do not apply excessive force to the door and door handle. It may be damaged.

Door locks inside the vehicle

Unlocking with the door handle

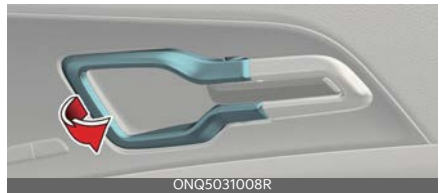

Operation

1. Front door

If the inner door handle is pulled when the door is locked, the door will unlock and open.
2. Rear door

If the inner door handle is pulled once when the door is locked, the door will

unlock. If the inner door handle is pulled once more, the door will open.

⚠ WARNING

- If a power door lock ever fails to function whilst you are in the vehicle, try one or more of the following techniques to exit:
 - Operate the door unlock feature repeatedly (both electronic and manual) whilst simultaneously pulling on the door handle.
 - Operate the other door locks and handles, front and rear.
 - Lower a front window and use the key to unlock the door from outside.
 - Move to the cargo area and open the tailgate.
- Do not pull the inner door handle of driver's (or passenger's) door whilst the vehicle is moving.

Locking/unlocking with the central door lock switch



- 1 Door lock button
- 2 Door unlock button
- 3 Door indicator light

Operation

1. Press the corresponding button below.
 - Switch (1): Lock
 - Switch (2): Unlock

* INFORMATION

- When all vehicle doors are locked, the door indicator light (3) on the driver's door and passenger's door will turn on. If any door is unlocked, it would go off.
- If any door is opened, the doors will not lock even though the central door lock switch is pressed.

⚠ WARNING

- The doors should always be fully closed and locked whilst the vehicle is in motion to prevent accidental opening of the door. Locked doors will also discourage potential intruders when the vehicle stops or slows down.
- Be careful when opening doors and watch out for vehicles, motorcycles, bicycles or pedestrians approaching the vehicle in the path of the door. Opening a door when something is approaching can result in an accident to cause vehicle damage or serious injury.
- Leaving your vehicle unlocked can increase the risk of vehicle theft or any possible criminal harm caused by someone hiding in your vehicle whilst you are gone. Always remove the ignition key, engage the parking brake, close all windows and lock all doors when leaving your vehicle unattended.
- **Unattended children, the elderly or pets**
An enclosed vehicle can become extremely hot, causing death or severe injury to unattended children or animals who cannot escape the vehicle. Furthermore, children might operate features of the vehicle that

could injure them, or they could encounter other harm, possibly from someone gaining entry to the vehicle. Never leave children or animals unattended in your vehicle.

Door lock features

Your vehicle is equipped with features that will automatically lock or unlock your vehicle based on settings you select in the cluster or infotainment system screen.

Auto lock enable on speed

When this feature is set in the cluster or infotainment system screen, all the doors will be locked automatically when the vehicle exceeds 15 km/h (9 mph).

Auto lock enable on shift

When this feature is set in the cluster or infotainment system screen, all the doors will be locked automatically when the vehicle is shifted out of P (Park) whilst the vehicle is running.

Auto unlock on shift to P

When this feature is set in the cluster or infotainment system screen, all the doors will be locked automatically when the vehicle is shifted out of P (Park) whilst the vehicle is running.

Auto unlock vehicle off

When this feature is set in the cluster or infotainment system screen, all the doors will be unlocked automatically when the vehicle is turned off.

Impact sensing door unlock system

All doors will automatically unlock when an impact causes the air bags to deploy.

Additional unlock safety feature air bag deployment

When this feature is set in the cluster or infotainment system screen, all the doors will be unlocked automatically when the vehicle is turned off.

Manual door lock switch



Operation

1. Open the door.
2. Insert the mechanical key.
3. Turn the key to the lock position.
4. Close the door securely.

Operating condition(s)

- The power door lock switch is not operating.

* NOTICE

If the electrical power to door lock switch is not operating (ex. dead car battery) and the tailgate is closed, you will not be able to open the tailgate until power is restored.

Rear door locks

Child-protector rear door lock

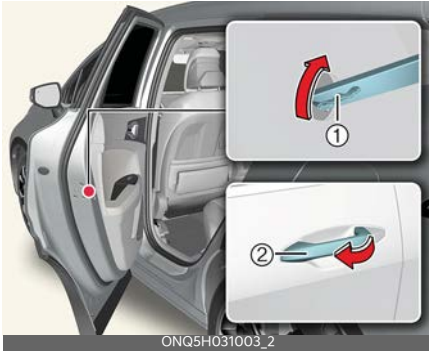

Operation

1. Insert the mechanical key.
2. Turn the child safety lock to the lock position (1).
3. To allow a rear door to be opened from inside the vehicle, unlock the child safety lock.
4. To open the rear door, pull the outside door handle (2).

⚠ WARNING

- If children accidentally open the rear doors whilst the vehicle is in motion, they could fall out and be severely injured or killed. To prevent children from opening the rear doors from the inside, the rear door safety locks should be used whenever children are in the vehicle.
- The system does not detect every obstacle approaching the vehicle exit.
- The driver and passenger are responsible for the accident occurred whilst exiting the vehicle. Always check the surrounding before you exit the vehicle.

Rear Occupant Alert (ROA)

The Rear Occupant Alert (ROA) is provided to help prevent exiting the vehicle with a rear passenger left in the vehicle.

Operation

1. Select **Convenience** → **Rear Occupant Alert** on the Settings menu.

Alert operation



A: Check rear seats

When you turn off the vehicle and open the driver's door after opening and closing the rear door or tailgate, the warning message appears on the cluster.

⚠ WARNING

Rear Occupant Alert provides information to the driver to check the rear seats but it does not detect whether there is an object or passenger in the back seats. Always make sure to check the rear seats before you leave the vehicle.

⚠ CAUTION

The door open and close history is initialized when the driver turns off the engine and locks the vehicle door. Even though the rear door is not opened again, an alert may occur if the previous history is not initialized. For example, if driver does not lock the vehicle door and opens the door to get off after the alert sounds, the alert may go off.

Driver position memory system (if equipped)

Setting memory position



Operation

- Adjust the following positions:
 - Driver's seat position (if equipped)
- After then, press '1' or '2' button.
 - Press and hold about 1 second.
 - It will beep sound twice.

* INFORMATION

The vehicle should be in the ON position to use this function.

Recalling memory position

Operation

- Press the '1' or '2' button.
 - Chime once
- After then, stored positions will be adjusted.

Non-operating condition(s)

- When driving speed exceeds 3 km/h (2 mph).

Resetting the driver position memory system

Operation

- Whilst the vehicle in ON position

- Move the driver seat as forward as possible.
- Move the seatback to a fully upright position.
- After then, press the '1' button and seat forward movement switch simultaneously for approximately 2 seconds.

Initialization

- Open the driver's door
- The seat and seatback will move backwards.
 - The beep will sound continuously.
- The seat and seatback will move to the centre position.
 - The beep sound will stop.

Easy access function

Operating condition(s)

- Driver's seat moves backward when:
 - The vehicle is in OFF position
 - The driver door is opened
- Driver's seat moves forward when:
 - The vehicle is in ACC or ON position
 - The driver door is closed when you have the smart key with you.

* INFORMATION

You can activate or deactivate the Easy Access Function from the Settings menu.

⚠ WARNING

Never attempt to operate the driver position memory system whilst the vehicle is moving. This could result in loss of control, and an accident causing death, serious injury, or property damage.

* NOTICE

- If the battery is disconnected, the memory settings will be erased.
- If the Driver Position Memory System does not operate normally, we recommend that you have the system checked by an authorised Kia dealer/service partner.

Tailgate

Opening/closing the manual tailgate



Operation

1. Press the outside handle switch (1) to open the tailgate.
2. Pull up the tailgate.
3. Push down the tailgate to close it.
Make sure that the tailgate is securely latched.

Operating condition(s)

- The tailgate is locked or unlocked using the key or central door lock switch.

Power tailgate (if equipped)

Operating the power tailgate

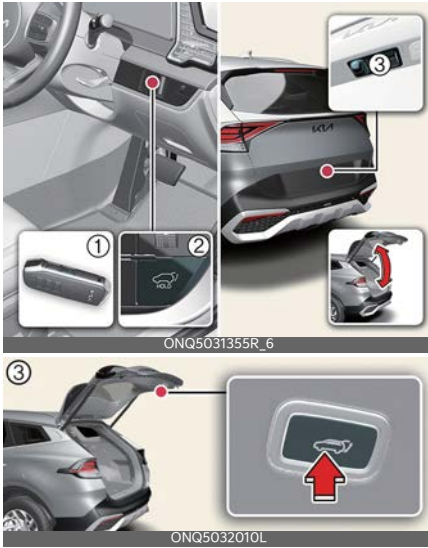

Operation

- 1 Press the power tailgate open/close button inside the vehicle or with the smart key for 1 second. The power tailgate opens with a warning sound. Press and hold the power tailgate open/close button inside the vehicle or with the smart key to close the tailgate.
 - Whilst the tailgate is opening, press the power tailgate open/close button again to stop tailgate operation.
 - If you release the power tailgate open/close button whilst the tailgate is closing, or the smart key is not within operation range (approximately 10 m (33 ft.)) from the vehicle, power tailgate operation will stop with a warning sound for 5 seconds.

- 2 The tailgate will open or close with a warning sound when the power tailgate open/close button outside the vehicle.

If the vehicle is locked, press the power tailgate open/close button outside the vehicle with the smart key in your possession.
- 3 Press the power tailgate open/close button inside the tailgate. The tailgate opens or closes with a warning sound.

Operating condition(s)

- When the gear is in P (Park, Automatic transmission) or N (Neutral, Manual transmission) with the vehicle in ON position
- When the vehicle is in OFF position

Non-operating condition(s)

- The vehicle speed is above 3 km/h (1.8 mph)

Automatic reverse

If the power tailgate senses any obstacle, the tailgate will stop or will fully open.

Operating condition(s)

- If the power tailgate senses any obstacles

Non-operating condition(s)

- If the detected resistance is below a certain level
- If the tailgate is almost fully closed near the latched position
- If a strong impact is applied with no obstructions placed

⚠ WARNING

- Never leave children or animals unattended in your vehicle. Children may operate the power tailgate. Doing so can result in injury to themselves or others and can damage the vehicle.
- Make sure that there are no people or objects in the path of the power tailgate or smart tailgate prior to use. Serious injury, damage to the vehicle or damage to surrounding objects (for example, walls, ceilings, vehicles, etc.) may result if contact with the tailgate occurs.



- A: 70 cm
- B: 70 cm

- A tailgate covered with snow or equipped with heavy objects (e.g. bike racks, ladders) may not be opened; with the tailgate open, it may be accidentally closed, causing injuries to anyone around the vehicle.
- Do not open the tailgate if the tailgate is covered with snow or equipped with heavy objects.
- Make sure to remove snow and heavy objects before opening the tailgate.
- Never intentionally place any object or part of your body in the path of the power tailgate to make sure the automatic reverse feature operates. Serious injury, or damage to the vehicle or object may occur.

⚠ CAUTION

- For safety, before attempting to open or close the tailgate, make sure the vehicle is in P (Park, Automatic transmission) or N (Neutral, Manual transmission) with the parking brake applied.
- Do not close or open the tailgate manually. This may cause damage to the power tailgate. If it is necessary to close or open the tailgate manually when the battery is discharged or disconnected, do not apply excessive force.
- Do not operate the power tailgate more than 10 times continuously when the engine is not running. Use the power tailgate with the engine running when the power tailgate is used repeatedly to prevent battery discharge.
- Do not leave the power tailgate open for a long period of time. This may drain the battery.
- Do not apply excessive force when the power tailgate is operating. Doing so could result in vehicle damage.
- Do not grab or hold on to the tailgate support struts at any time. Damage to the tailgate support struts could result. Deformation of the tailgate support struts may cause vehicle damage and personal injury may occur.



- Do not modify or repair any part of the power tailgate by yourself. This

must be done by an authorised Kia dealer/service partner.

- Do not operate the power tailgate under the following conditions. The power tailgate may not operate properly.
 - One side of the vehicle is lifted to inspect the vehicle or change a tyre
 - Parking on an uneven road such as a slope, etc.
- Close the tailgate completely and lock all doors and tailgate using the central door lock button before using an automatic car wash.
- Do not spray high pressure water directly on the power tailgate outside open/close button. The tailgate may open unintentionally.

* NOTICE

- If the tailgate is not fully closed and vehicle speed is at or above 3 km/h (1.8 mph), a warning will sound 10 times. Immediately park the vehicle at a safe place, close the tailgate, and check that the tailgate open warning on the instrument cluster is turned off.
- In cold and wet climates, the outside power tailgate open/close button may not work properly due to freezing conditions. If this occurs, remove the ice before using the outside power tailgate open/close button or use the power tailgate open/close button on the smart key or the instrument panel.
- Operating the power tailgate more than 5 times continuously could cause damage to the operating motor. If this occurs, the power tailgate will not operate to prevent the motor from overheating. If any of the power tailgate buttons are pressed to try to open the tailgate, the chime will sound

3 times, but the tailgate will remain closed. Allow the power tailgate system to cool for about 1 minute before operating the system again.

- The power tailgate may stop operating if the automatic reverse feature operates more than two times whilst attempting to open or close the tailgate. If this occurs, carefully open or close the tailgate manually, and then after 30 seconds try to operate the power tailgate automatically again.

Setting the power tailgate

Power tailgate opening speed

You can adjust the power tailgate opening speed. Select the desired opening speed (**Fast/Slow**) (Default setting is **Fast**).

Operation

- **Instrument cluster**
Select **User Settings** → **Door** → **Power Tailgate Opening Speed** → **Fast/Normal**.
- **Infotainment system (if equipped)**
Select **Setup** → **Vehicle Settings** → **Door** → **Power Tailgate Opening Speed** → **Fast/Normal**.

Power tailgate opening height

You can adjust the power tailgate opening height. Select the desired opening height (**Full Open/Level 3/Level 2/Level 1/User Height Setting**).

Operation

- **Instrument cluster**
Select **User Settings** → **Door** → **Power Tailgate Opening Height** → **Full Open/Level 3/Level 2/Level 1/User Height Setting**.

- **Infotainment system (if equipped)**
 Select **Setup** → **Vehicle Settings** → **Door** → **Power Tailgate Opening Height** → **Full Open/Level 3/Level 2/Level 1/User Height Setting**.

User height setting

Operation

1. Position the tailgate manually to the height you prefer.
2. Press the power tailgate open/close button located inside the tailgate for more than approximately 3 seconds.
 If **User Height Setting** is selected for the power tailgate opening height, the power tailgate will automatically open to the height manually set by you.

* INFORMATION

- The infotainment system may change after software updates. For more information, refer to the manual provided in the infotainment system and the quick reference guide.
- To use each feature, you must select the opening speed or opening height from the settings menu. Deselect the settings when you do not want to use the feature.
- If the power tailgate opening height has not been manually set, the power tailgate will fully open when 'User Height Setting' from the infotainment system is selected.
- If one of the height setting (**Full Open/Level 3/Level 2/Level 1/User Height Setting**) is selected from the settings menu in the infotainment system, and then 'User Height Setting' is selected, the tailgate will open to the height manually set by you.

- The power tailgate opening speed and opening height settings change according to the linked User Profile. If the User Profile is changed, power tailgate opening speed and opening height settings will change accordingly.

Resetting the power tailgate

Operation

1. With the vehicle in OFF or ON position, shift to P (Park, Automatic transmission) or N (Neutral, Manual transmission).
2. Press the power tailgate open/close button inside the tailgate and the power tailgate open/close button outside the vehicle simultaneously until a chime sounds.



3. Slowly close the tailgate manually.
4. Press the power tailgate open/close button outside the vehicle. The power tailgate will open with a chime sound.

* NOTICE

- In some circumstances resetting the power tailgate operation may need to be performed. Some instances where resetting the power tailgate may be required include:

- When the 12-volt battery is recharged
- When the 12-volt battery is reinstalled after removal or replacement
- When the related fuse is reinstalled after removal or replacement
- Wait until the tailgate fully opens to complete resetting. If the tailgate stops before it is fully open, resetting cannot be completed.
- If the power tailgate does not operate properly after the above procedure, we recommend the system inspected by an authorised Kia dealer/service partner.

partment of the vehicle at any time. The luggage compartment is a very dangerous location in the event of an accident.

- Use the release latch for emergencies only. Use extreme caution, especially whilst the vehicle is in motion.

Emergency tailgate safety release



Operation

1. Insert a long, flat object, such as a key into the opening at the bottom of the tailgate.
2. Slide the latch in the direction of the arrow to unlock the tailgate.
3. Push the tailgate to open.

⚠ WARNING

- For emergencies, be fully aware of the location of the emergency tailgate safety release latch in the vehicle and how to open the tailgate if you are accidentally locked in the luggage compartment.
- No one, including animals, should be allowed to occupy the luggage com-

Windows



1. Driver's door power window switch
2. Front passenger's door power window switch
3. Rear door (left) power window switch
4. Rear door (right) power window switch
5. Power window lock switch

Controlling power windows switch



- Type A: 1
- Type B: 1, 2 (if equipped)

Operation

- Press or pull the switch to the first/second detent position (1, 2).

* INFORMATION

Only type B can use auto up/down function.

Operating condition(s)

- The vehicle is in the ON position

⚠ WARNING

Do not install any accessories in the area of windows. It may impact jam protection.

* NOTICE

- Whilst driving with the rear windows down or with the sunroof (if equipped) in an open (or partially open position), your vehicle may demonstrate a wind buffeting or pulsation noise. This noise is a normal occurrence and can be reduced or eliminated by taking the following actions. If the noise occurs with one or both of the rear windows down, partially lower both front windows approximately 2.5 cm (1 inch). If you

experience the noise with the sunroof open, slightly reduce the size of the sunroof opening.

- In cold and wet climates, power windows may not work properly due to freezing conditions.

Resetting power windows

Operation

1. Close the window.
 - Approximately 1 second

Operating condition(s)

- The vehicle is in the ON position.

Power windows automatic reversal

Operation

1. Windows will stop and move down.
 - Approximately 30 cm (12 inches)
2. Windows will move down.
 - Approximately 2.5 cm (1 inches)

Operating condition(s)

- Object or part of the body is detected
- Force is detected

⚠ WARNING

- Always check for obstructions before raising any window to avoid injuries or vehicle damage. If an object less than 4 mm (0.16 inches) in diameter is caught between the window glass and the upper window channel, the automatic reverse window may not detect the resistance and will not stop and reverse direction.

- The automatic reverse feature is not activated whilst resetting power window system. Make sure body parts or other objects are safely out of the way before closing the windows to avoid injuries or vehicle damage.

* NOTICE

The automatic reverse feature for the window is only active when the "auto up" feature is used by fully pulling up the switch. The automatic reverse feature will not operate if the window is raised using the halfway position on the power window switch.

Power windows lock button



Operation

1. Push the power windows lock button.
 - Rear passenger window is inoperable.
2. The front driver and passenger window can be operated.

⚠ WARNING

- NEVER leave the keys in your vehicle with unsupervised children, when the engine is running.
- NEVER leave any child unattended in the vehicle. Even very young children may inadvertently cause the vehicle to move, entangle themselves in the windows, or otherwise injure themselves or others.

- Always double check to make sure all arms, hands, head and other obstructions are safely out of the way before closing a window.
- Do not allow children play with the power windows. Keep the driver's door power window lock button in the LOCK position (pressed). SERIOUS INJURY can result from unintentional window operation by the child.
- Do not extend heads or any limbs outside the window whilst the vehicle is in motion.

⚠ CAUTION

- To prevent possible damage to the power window system, do not open or close two windows or more at the same time. This will also ensure the longevity of the fuse.
- Never try to operate the main switch on the driver's door and the individual door window switch in opposite directions at the same time. If this is done, the window will stop and cannot be opened or closed.

Remote window closing/opening (if equipped)



- 1 Lock button
- 2 Unlock button

If Auto window up/down function (safety window function) is equipped, you can still control the corresponding windows movement with engine turned off.

Operation

1. Press and hold the door lock button (1) on the smart key to close the windows. The windows will move up as long as the button is pressed.
2. Press and hold the door unlock button (2) on the smart key to open the windows. The windows will move down as long as the button is pressed.
3. Remote window operation can be activated or deactivated from the Settings menu.

WARNING

- Do not install any accessories in the area of windows. It may impact jam protection.
- Always check for obstructions before raising any window to avoid injuries or vehicle damage. If an object less than 4 mm (0.16 inches) in diameter is

caught between the window glass and the upper window channel, the automatic reverse window may not detect the resistance and will not stop and reverse direction.

- The automatic reverse feature is not activated whilst resetting power window system. Make sure body parts or other objects are safely out of the way before closing the windows to avoid injuries or vehicle damage.
- NEVER leave the keys in your vehicle with unsupervised children, when the vehicle is running.
- NEVER leave any child unattended in the vehicle. Even very young children may inadvertently cause the vehicle to move, entangle themselves in the windows, or otherwise injure themselves or others.
- Always double check to make sure all arms, hands, head and other obstructions are safely out of the way before closing a window.
- Do not allow children play with the power windows. Keep the driver's door power window lock button in the LOCK position (pressed). **SERIOUS INJURY** can result from unintentional window operation by the child.
- Do not extend heads or any limbs outside the window whilst the vehicle is in motion.
- Make sure body parts of other objects are safely out of the way before remote closing the windows to avoid injuries or vehicle damage.

CAUTION

- To prevent possible damage to the power window system, do not open or close two windows or more at the

same time. This will also ensure the longevity of the fuse.

- Never try to operate the main switch on the driver's door and the individual door window switch in opposite directions at the same time. If this is done, the window will stop and cannot be opened or closed.

*** NOTICE**

- Whilst driving with the rear windows down or with the sunroof (if equipped) in an open (or partially open position), your vehicle may demonstrate a wind buffeting or pulsation noise. This noise is a normal occurrence and can be reduced or eliminated by taking the following actions. If the noise occurs with one or both of the rear windows down, partially lower both front windows approximately one inch. If you experience the noise with the sunroof open, slightly reduce the size of the sunroof opening.
- In cold and wet climates, power windows may not work properly due to freezing conditions.
- The automatic reverse feature for the window is only active when the "auto up" feature is used by fully pulling up the switch. The automatic reverse feature will not operate if the window is raised using the halfway position on the power window switch.

Bonnet

Opening the bonnet



- 1 Bonnet release lever
- 2 Secondary bonnet release lever
- 3 Bonnet
- 4 Support rod

Operation

1. Pull the bonnet release lever (1).
2. Push the secondary bonnet release lever (2) to the left.
3. Lift the bonnet (3) upwards.
4. Pull out the support rod (4).
5. Hold the bonnet opened with the support rod.

⚠ WARNING

Open the bonnet after turning off the engine on a flat surface, shifting the gear to the P (Park) position and setting the parking brake.

Closing the bonnet



Operation

1. Before closing the bonnet, check the following:
 - All filler caps in the engine compartment must be correctly installed.
 - Gloves, rags or any other combustible material must be removed from the engine compartment.
2. Lower the bonnet until it is about 30 cm (12 inches) above the closed position and let it drop. Make sure that it locks into place.
3. Check that the bonnet has engaged properly.
 - If the bonnet can be raised slightly, it is not properly engaged.
 - Open it again and close it with a little more force.

WARNING

- Before closing the bonnet, ensure that all obstructions are removed from the bonnet opening. Closing the bonnet with an obstruction present in the bonnet opening may result in property damage or severe personal injury.
- Do not leave gloves, rags or any other combustible material in the engine compartment. Doing so may cause a heat-induced fire.
- Always double check to be sure that the bonnet is firmly latched before

driving away. If it is not latched, the bonnet could open whilst the vehicle is being driven, causing total loss of visibility, which might result in an accident.

- Do not move the vehicle with the bonnet raised. The view will be blocked and the bonnet could fall or be damaged.

Fuel filler door

Opening the fuel filler door



Operation

1. Turn the engine off.
2. Ensure all the doors are unlocked.
3. Press the rear centre edge to open the fuel filler door (1).
4. Remove the fuel tank cap (2) by turning it counterclockwise.
5. Place the cap on the fuel filler door.

⚠ WARNING

Before refuelling, be sure to check what type of fuel is used for your vehicle.

If you put diesel fuel into a petrol-powered vehicle or petrol into a diesel-powered vehicle, it may affect the fuel system and cause serious damage to the vehicle.

* NOTICE

- The fuel filler door will unlock when driver's door is unlocked.
To unlock fuel filler door:
 - Press the unlock button on your smart key.
 - Press the central door unlock button on armrest trim of driver's door.
 - Pull the driver's inside door handle outward.
 The fuel filler door will lock when all doors are locked.
To lock fuel filler door:

- Press the lock button on your smart key.
- Press the central door lock button on armrest trim of driver's door.
- * All doors will automatically lock after the vehicle speed exceeds 15 km/h (9 mph). Fuel door is also locked when vehicle speed exceeds 15 km/h (9 mph).
- If the fuel filler door does not open because ice has formed around it, tap lightly or push on the door to break the ice and release the door. Do not pry on the door. If necessary, spray around the door with an approved de-icer fluid (do not use radiator anti-freeze) or move the vehicle to a warm place and allow the ice to melt.

Closing the fuel filler door

Operation

1. Turn the fuel tank cap (2) clockwise until it "clicks".
2. Press the rear centre edge to close the fuel filler door (1).
3. Ensure all the doors and the fuel filler door are locked.

⚠ WARNING

Petrol is highly flammable and explosive. Failure to follow these guidelines may result in SERIOUS INJURY or DEATH:

- Read and follow all warnings posted at the gas station.
- Before refuelling, note the location of the Emergency Petrol Shut-Off, if available, at the gas station.
- Before touching the fuel nozzle, you should eliminate the potential build-up of static electricity by touching a metal part of the vehicle, a safe dis-

tance away from the fuel filler neck, nozzle, or other gas source, with your bare hand.

- Do not use cellular phones whilst refuelling. Electric current and/or electronic interference from cellular phones can potentially ignite fuel vapours and cause a fire.
- Do not get back into a vehicle once you have begun refuelling. You can generate a build-up of static electricity by touching, rubbing or sliding against any item or fabric capable of producing static electricity. Static electricity discharge can ignite fuel vapours causing a fire. If you must re-enter the vehicle, you should once again eliminate potentially dangerous static electricity discharge by touching a metal part of the vehicle, away from the fuel filler neck, nozzle or other petrol source, with your bare hand.
- When refuelling, always shift the gear to the P (Park) position, set the parking brake, and place the ignition switch or ENGINE START/STOP button to the LOCK/OFF position.
- Sparks produced by electrical components related to the engine can ignite fuel vapours causing a fire.
- When using an approved portable fuel container, be sure to place the container on the ground prior to refuelling. Static electricity discharge from the container can ignite fuel vapours causing a fire. Once refuelling has begun, contact between your bare hand and the vehicle should be maintained until the filling is complete.
- Use only approved portable plastic fuel containers designed to carry and store petrol.
- Do not use matches or a lighter and do not smoke or leave a lit cigarette in your vehicle whilst at a gas station, especially during refuelling.
- Do not over-fill or top-off your vehicle tank, which can cause petrol spillage.
- If a fire breaks out during refuelling, leave the vicinity of the vehicle, and immediately contact the manager of the gas station and then contact the local fire department. Follow any safety instructions they provide.
- If pressurized fuel sprays out, it can cover your clothes or skin and thus subject you to the risk of fire and burns. Always remove the fuel cap carefully and slowly. If the cap is venting fuel or if you hear a hissing sound, wait until the condition stops before completely removing the cap.
- Always check that the fuel cap is installed securely to prevent fuel spillage in the event of an accident.

CAUTION

Keep the door into LOCK position when the vehicle is being washed (i.e. high pressure washer, automatic car washer, etc.)

NOTICE

- Make the vehicle door to LOCK position when the fuel filler door is completely closed in order to lock the fuel filler door. If the fuel filler door is not completely closed, the fuel filler door will not be locked.
- Make sure to refuel your vehicle according to the fuel requirements.
- Do not spill fuel on the exterior surfaces of the vehicle. Any type of fuel

spilled on painted surfaces may damage the paint.

- If the fuel filler cap requires replacement, use only Kia Genuine Parts or those of an equivalent standard for your vehicle. An incorrect fuel filler cap can result in a serious malfunction of the fuel system or emission control system.
-

Panorama sunroof (if equipped)

If your vehicle is equipped with a sunroof, you can slide or tilt your sunroof with the sunroof switch located on the overhead console.



The sunroof can only be operated when the ignition switch or ENGINE START/STOP button is in the ON or START position.

The sunroof can be operated for approximately 3 minutes after the ignition switch or Engine Start/Stop button is in the ACC or LOCK/OFF position. However, if the front door is open, the sunroof cannot be operated even within the 3 minute period.

⚠ WARNING

- Adjust the sunroof or sunshade when your vehicle stops. This could result in loss of control and an accident that may cause injury, or property damage.
 - Do not leave the engine running and the key in your vehicle with unsupervised children. Unattended children could operate the sunroof, which could result in serious injury.
 - Do not sit on the top of the vehicle. It may cause injury or vehicle damage.
-

*** NOTICE**

Do not operate the sunroof when roof bars are installed on the vehicle or when there is luggage on the roof.

Power sunshade

Use the power sunshade to block direct sunlight coming through the sunroof glass.

- Push the sunroof switch rearward to the first detent position, the power sunshade automatically slides open.
- Push the sunroof switch forward to the first detent position, the power sunshade automatically closes. However, if the sunroof glass is open, the glass will close first.

To stop the power sunshade at any point, push the sunroof switch in any direction.

*** NOTICE**

Do not pull or push the power sunshade by hand as such action may damage the power sunshade or cause it to malfunction.

*** INFORMATION**

Wrinkles formed on the power sunshade are normal due to material characteristic.

Tilt open/close

- Push the sunroof switch upward, the sunroof glass tilts open. However, if the power sunshade is close, the sunshade will open first.
- Push the sunroof switch upward or forward when the sunroof glass is tilt opened, the sunroof glass automatically closes.

To stop the sunroof movement at any point, push the sunroof switch in any direction.

Slide open/close

- Push the sunroof switch rearward to the first detent position, the sunroof glass opens. However, if the power sunshade is close, the power sunshade will open first.
Push the sunroof switch forward to the first detent position, the sunroof glass closes. However, if the sunroof glass is close, the power sunshade will close.
- Push the sunroof switch forward or rearward to the second detent position, the power sunshade and sunroof glass operate automatically (auto slide feature).

To stop the sunroof movement at any point, push the sunroof switch in any direction.

Automatic reversal



If the power sunshade or sunroof glass senses any obstacle whilst it is closing automatically, it will reverse direction then stop at a certain position.

The auto reverse function may not work if an object thin or soft is caught between the sliding power sunshade or sunroof glass and sunroof sash.

⚠ WARNING

- Make sure heads, hands, arms or any other body parts or objects are out of the way before operating the sunroof. Body parts or objects may get caught causing injuries or vehicle damage.
- Never deliberately use your body parts to test the automatic reversal function. The power sunshade or sunroof glass may reverse direction, but there is a risk of injury.

*** NOTICE**

- Do not continue to push the sunroof switch after the sunroof is fully opened, closed, or tilted. Damage to the sunroof motor could occur.
- Continuous operations such as slide open/close, tilt open/close, etc. may cause the motor or sunroof system to malfunction.

- Regularly remove any accumulated dust on the sunroof rail.
- Dust accumulated between the sunroof and roof panel can make noise. Open the sunroof and remove dust regularly using a clean cloth.
- Do not try to open the sunroof when the temperature is below freezing or when the sunroof is covered with snow or ice. The sunroof may not work properly and may break if opened by force.
- Do not open or drive with the sunroof glass open immediately after rain or washing the vehicle. Water may wet the interior of the vehicle.
- Do not extend any luggage outside the sunroof whilst driving. Vehicle damage may occur if the vehicle suddenly stops.

⚠ WARNING

Do not extend your head, arms, body parts or objects outside the sunroof whilst driving. Injuries may occur if the vehicle suddenly stops.

Resetting the sunroof



In some circumstances resetting the sunroof operation may need to be performed. Some instances where resetting the sunroof may be required include:

- When the 12-volt battery is either disconnected or discharged
- When the sunroof fuse is replaced
- If the sunroof one-touch AUTO OPEN/CLOSE operation is not functioning properly

Sunroof resetting procedure

1. It is recommended to perform the reset procedure with the vehicle engine running. Start the vehicle in P (Park).
2. Make sure the power sunshade and sunroof glass are in the fully closed position. If the power sunshade and sunroof glass are open, push the switch forward until the power sunshade and sunroof glass are fully closed.
3. Release the switch when the power sunshade and sunroof glass are fully closed.
4. Push the switch forward until the power sunshade and sunroof glass move slightly. Then release the switch.
5. Once again push and hold the sunroof switch forward until the power sunshade and sunroof glass slide open and close. Do not release the

switch until the operation is completed.

If you release the switch during operation, start the procedure again from step 2.

* INFORMATION

If the sunroof does not reset when the vehicle battery is disconnected or discharged, or the sunroof fuse is blown, the sunroof may not operate normally.

Sunroof open warning



If the driver turns off the engine when the sunroof is not fully closed, the warning chime will sound for several seconds and the sunroof open warning will appear on the cluster LCD display.

Close the sunroof securely when leaving your vehicle.

⚠ CAUTION

Make sure the sunroof is closed fully when leaving your vehicle. If the sunroof is left open, rain or snow may wet the interior of the vehicle. Also, leaving the sunroof open when the vehicle is unattended may invite theft.

Steering wheel

Adjusting steering wheel angle and height



Operation

1. Pull the lock-release lever (1) down.
2. Adjust the steering wheel to the desired angle (2) and height (3).
3. Pull the lock-release lever up.

* INFORMATION

Be sure to adjust the steering wheel to the desired position before driving.

⚠ WARNING

- Never adjust the angle and height of the steering wheel whilst driving. You may lose steering control and cause severe personal injury, death or accidents.
- After adjusting, push the steering wheel both up and down to be certain it is locked in position.
- Whilst adjusting the steering wheel angle and height, please do not push or pull it hard since the fixture can be damaged.

⚠ CAUTION

Do not press or pull the steering wheel hardy whilst adjusting. The steering wheel column may be damaged.

* NOTICE

- After adjustment, sometimes the lock-release lever may not lock the steering wheel.

It is not a malfunction. This occurs when two gears engage. In this case, adjust the steering wheel again and then lock the steering wheel.

- The following symptoms may occur during normal vehicle operation:
 - The EPS warning light does not appear.
 - The steering effort is high immediately after turning the ignition switch or ENGINE START/STOP button on. This happens as the EPS system performs the diagnostics. When the diagnostics is completed, the steering effort will return to its normal condition.
 - A click noise may be heard from the EPS relay after the ignition switch or ENGINE START/STOP button is turned to the ON or LOCK position.
 - Motor noise may be heard when the vehicle is at a stop or at a low driving speed.
 - When the abnormality is detected in the electric power steering system, a deadly accident prevention purposes, steering assist functions will be stopped. At this time, the instrument panel warning light turns on or blinks and the power to manipulate the steering will be off. Please check immediately after moving the vehicle to a safe zone.

- The steering effort increases if the steering wheel is rotated continuously when the vehicle is not in motion. However, after a few minutes, it will return to its normal conditions.
- If the Electric Power Steering System does not operate normally, the warning light will appear on the instrument cluster. The steering wheel may become difficult to control or operate abnormally. In this case, have the system inspected by a professional workshop. Kia recommends to visit an authorised Kia dealer/service partner.
- When you operate the steering wheel in low temperature, abnormal noise could occur. If temperature rises, the noise will disappear. This is a normal condition.
- When jump starting the vehicle after battery discharge, the steering wheel may not function properly. It is a temporary situation due to low battery voltage, and upon stable battery charging, the steering wheel will function normally again. Please move the steering wheel around to make sure the steering wheel is functioning properly before driving the vehicle.

Heated steering wheel (if equipped)



Operation

1. Press the button to turn the heated steering wheel ON or OFF.
2. The heated steering wheel reverts to the OFF position whenever the vehicle is restarted.

* INFORMATION

The heated steering wheel automatically controls the steering wheel temperature depending on the ambient temperature when the vehicle is running. For more details, refer to "Auto. controls that use climate control settings (for driver's seat) (if equipped)" on page 4-84.

⚠ WARNING

If the steering wheel becomes too warm, turn the system off. The heated steering wheel may cause burns even at low temperatures, especially if used for long periods of time.

⚠ CAUTION

- Do not install any type of grip cover for the steering wheel, it may impair the function of the heated steering wheel system.
- When cleaning the heated steering wheel, do not use an organic solvent such as paint thinner, benzene, alco-

hol and petrol. Doing so may damage the surface of the steering wheel.

- If the surface of the steering wheel is damaged by a sharp object, damage to the heated steering wheel components could occur.

* NOTICE

The heated steering wheel will turn off automatically approximately 30 minutes after the heated steering wheel is turned on.

Horn



Operation

- Press the area around the horn symbol on your steering wheel.

⚠ CAUTION

- Do not strike the horn severely to operate it, or hit it with your fist. Do not press on the horn with a sharp-pointed object.
- When cleaning the steering wheel, do not use an organic solvent such as thinner, benzene, alcohol and petrol. Doing so may damage the steering wheel.

Mirrors

Inside rear view mirror

Adjusting the day/night rear view mirror (if equipped)



- A: Day
- B: Night

Operation

1. Push the day/night lever (1) during daytime.
2. Pull the day/night lever (2) to reduce the headlamp glare during low light and night driving conditions.

Electric Chromic Mirror (ECM) (if equipped)

The sensor detects the light level and automatically controls the headlamp glare during low light and night driving conditions.

⚠ WARNING

- Do not place objects in the rear seat or cargo area which would interfere with your vision out the rear window.
- Do not adjust the rear view mirror whilst the vehicle is moving. This could result in loss of control, and an accident which could cause DEATH, SERIOUS INJURY, or property damage.
- Do not modify the inside mirror and don't install a wide mirror. It could

result in injury, during an accident or deployment of the air bag.

Outside rear view mirror

Adjusting the outside rear view mirror



Operation

1. Move the outside rear view mirror switch (1) to select the left or right side of the mirror.
2. Adjust the mirror adjustment control (2) to move the selected mirror.

⚠ WARNING

- The outside rear view mirror is convex. Objects seen in the mirror are closer than they appear.
- Use your interior rear view mirror or direct observation to determine the actual distance of following vehicles when changing lanes.
- Do not adjust or fold the outside rear view mirrors whilst the vehicle is moving. This could result in loss of control, and an accident which could cause DEATH, SERIOUS INJURY, or property damage.

⚠ CAUTION

- Do not scrape ice off the mirror face; this may damage the surface of the glass. If ice should restrict the movement of the mirror, do not force the mirror for adjustment. To remove ice, use a deicer spray, or a sponge or soft cloth with warm water.
- If the mirror is jammed with ice, do not adjust the mirror by force. Use an approved spray de-icer (not radiator antifreeze) to release the frozen mechanism or move the vehicle to a warm place and allow the ice to melt.
- The mirrors stop moving when they reach the maximum adjusting angles, but the motor continues to operate whilst the switch is pressed. Do not press the switch longer than necessary, the motor may be damaged.
- Do not attempt to adjust the outside rear view mirror by hand. Doing so may damage the parts.

Folding the outside rear view mirror

Manual type (if equipped)



Operation

- Grasp the housing of the mirror and fold it toward the rear of the vehicle.

Electric type (if equipped)



Operation

- Press the button to fold or unfold the mirror.

Instrument cluster

Type A

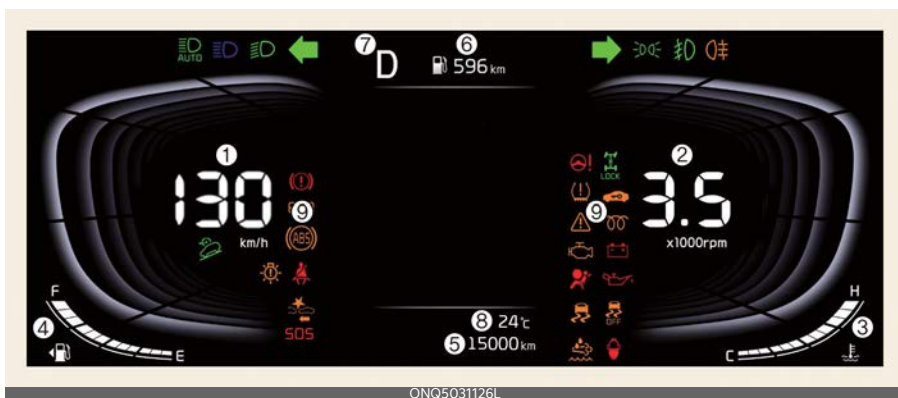

4

Type B



1. Speedometer

- km/h, MPH
- The speed of the vehicle in kilometers per hour (km/h) or miles per hour (mph).

2. Tachometer

- Indicates the approximate number of engine revolutions per minute (rpm).

3. Engine coolant temperature gauge

- Indicates the temperature of the engine coolant.

4. Fuel gauge

- Indicates the approximate amount of fuel remaining in the fuel tank.

5. Odometer

- Indicates the total distance that the vehicle has been driven.

6. Distance to empty

- Indicates the distance the vehicle can be driven with the remaining fuel.

7. Transmission shift indicator (if equipped)

- Indicates which gear is selected.

Automatic transmission shift indicator (if equipped)



This indicator displays which automatic transmission gear is selected.

- Park: P
- Reverse: R
- Neutral: N
- Drive: D

Manual shift mode

- Shifting up: ▲2, ▲3, ▲4, ▲5, ▲6, ▲7*, ▲8*
- Shifting down: ▼1, ▼2, ▼3, ▼4, ▼5, ▲6*, ▲7*

* : if equipped

Automatic transmission shift indicator in manual shift mode (if equipped)

In the Manual shift mode, this indicator informs which gear is desired whilst driving to save fuel.

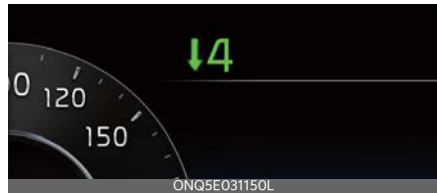

- Shifting up: ▲2, ▲3, ▲4, ▲5, ▲6, ▲7*, ▲8*
- Shifting down: ▼1, ▼2, ▼3, ▼4, ▼5, ▲6*, ▲7*

* : if equipped

For example

- ▲3: Indicates that shifting up to the 3rd gear is desired (currently the shift lever is in the 2nd or 1st gear).
- ▼3: Indicates that shifting down to the 3rd gear is desired (currently the shift lever is in the 4th, 5th or 6th gear).

When the system is not working properly, the indicator is not displayed.

Manual transmission shift indicator (if equipped)



This indicator informs which gear is desired whilst driving to save fuel.

- Shifting up: ▲2, ▲3, ▲4, ▲5, ▲6
- Shifting down: ▼1, ▼2, ▼3, ▼4, ▼5

For example

- ▲3: Indicates that shifting up to the 3rd gear is desired (currently the shift lever is in the 2nd or 1st gear).
- ▼3: Indicates that shifting down to the 3rd gear is desired (currently the shift lever is in the 4th, 5th or 6th gear).

When the system is not working properly, the indicator is not displayed.

Dual clutch transmission shift indicator (if equipped)



This indicator displays which shift lever is selected.

- Park: P
- Reverse: R
- Neutral: N
- Drive: Drive: D₁, D₂, D₃, D₄, D₅, D₆, D₇
- Manual mode: S₁, S₂, S₃, S₄, S₅, S₆, S₇

Dual clutch transmission shift indicator in manual shift mode (if equipped)

In the Manual shift mode, this indicator informs which gear is desired whilst driving to save fuel.



- Shifting up: ▲2, ▲3, ▲4, ▲5, ▲6, ▲7
- Shifting down: ▼1, ▼2, ▼3, ▼4, ▼5, ▼6

For example

- ▲3: Indicates that shifting up to the 3rd gear is desired (currently the shift lever is in the 2nd or 1st gear).
- ▼3: Indicates that shifting down to the 3rd gear is desired (currently the shift lever is in the 4th, 5th or 6th gear).

When the system is not working properly, the indicator is not displayed.

8. Outside temperature gauge

- Indicates the current outside air temperatures.

9. Warning and indicator lights

- Refer to "Warning and indicator lights" on page 4-55.

⚠ WARNING

- Never remove the engine coolant reservoir cap when the engine is hot. The engine coolant is under pressure and could severely burn. Wait until the engine is cool before adding coolant to the reservoir.

- Running out of fuel can expose vehicle occupants to danger. You must stop and obtain additional fuel as soon as possible after a low fuel warning light (🛢️) appears or when the gauge indicator comes close to the "E" level.

⚠️ CAUTION



- For full LCD type cluster (Type B), the information is displayed after getting information from a weather information provider via GPS. Depending on conditions of GPS reception, the information may be different from the current weather in your area. If no information is received via GPS (e.g., not subscribed to Kia Connect service), the weather and time will be displayed as 'sunny' and 'night' on the cluster.
- Be careful whilst driving as dynamic themed animation effects can distract the driver and lead to unexpected accidents.
- Do not operate the engine within the tachometer's red zone. This may cause severe engine damage.
- If the gauge pointer moves beyond the normal range area toward the "H" position, it indicates overheating that may damage the engine. Do not continue driving with an overheated engine. If your vehicle overheats, refer to "If the engine overheats" on page 8-6.
- The fuel gauge is supplemented by a low fuel warning light (🛢️), which will appear when the fuel tank is nearly empty.
- On inclines or curves, the fuel gauge pointer may fluctuate or the low fuel warning light may come on earlier than usual due to the movement of fuel in the tank.
- If the vehicle is not on level ground or the battery power has been interrupted, the distance to empty function may not operate correctly.
- The distance to empty may differ from the actual driving distance as it is an estimate of the available driving distance.
- The trip computer may not register additional fuel if less than 6 litres (1.6 gallons) of fuel are added to the vehicle.
- The fuel economy and distance to empty may vary significantly based on driving conditions, driving habits, and condition of the vehicle.
- Use a clean soft microfiber cloth to gently wipe any finger prints off the screen.
- Use a clean soft microfiber cloth to gently wipe any finger prints off the screen.

* NOTICE







- The fuel tank capacity is given in "Recommended lubricants and capacities" on page 10-7.

LCD display



1. : MODE button for changing modes
2. : MOVE switch for changing items
3. OK: SELECT/RESET button for setting or resetting the selected item

LCD display modes

| Mode | | | | | | |
|-----------------------|--|---|---|---|---|--|
| |  Driving Assist |  Trip Computer |  Turn By Turn (TBT)* |  User Settings |  Information |  Master Warning |
| ^ v Up/ Down | Forward Collision-Avoidance Assist* Lane Keeping Assist* Blind-Spot Collision-Avoidance Assist* Smart Cruise Control* Lane Following Assist* | Drive Information | Route Guidance | Driver Assistance* | Driving force distribution (4WD)* | The Master Warning mode displays warning messages related to the vehicle when one or more systems is not operating normally. |
| | Driver Attention Warning* | Since Refuelling | Destination Info | Cluster | TPMS | |
| | Intelligent Speed Limit Assist* | Accumulated Info | | Lights* | Urea Level* | |
| | | Digital Speedometer* | | Door* | | |
| | | | | Convenience* | | |
| | | Units | | | | |
| | | | Language | | | |
| | | | Reset | | | |

* : if equipped

Fuel economy



- 1 Average fuel economy
- 2 Instant fuel economy

1. Average fuel economy

The average fuel economy is calculated by the total driving distance and fuel consumption since the last average fuel economy reset.

- **At vehicle start:** The information will automatically reset when the driver's door is opened after the vehicle is turned off, or approximately 3 minutes have passed after the vehicle is turned off.
- **After refuelling:** After refuelling more than 6 litres (1.5 gallons) and driving over 1 km/h (1 mph), the vehicle will reset to default automatically.
- **Manually:** Press and hold the OK button on the steering wheel when the average fuel economy is displayed.

2. Instant fuel economy

Displays the instant fuel economy during the last few seconds when the vehicle speed is more than approximately 10 km/h (6 mph).

* INFORMATION

This information is always displayed at the bottom centre of the Full LCD cluster.

Driving Assist mode

This mode displays the state of:

- Forward Collision-Avoidance Assist
- Lane Keeping Assist
- Blind-Spot Collision-Avoidance Assist
- Smart Cruise Control
- Lane Following Assist
- Driver Attention Warning

Trip computer mode

* You may change through items in the following order.

Drive info

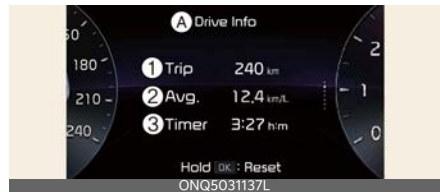

A: Drive info

- 1 Accumulated trip distance
- 2 Average fuel efficiency
- 3 Total driving time

The information after one ignition cycle. Drive Info screen will reset when the driver's door is opened after turning off the vehicle, or the vehicle is turned on after 3 minutes have passed.

To manually reset the information, press and hold the OK button on the steering wheel when viewing the Drive info.

Since refuelling



A: Since refuelling

- 1 Accumulated trip distance
- 2 Average fuel efficiency
- 3 Total driving time

The information after refuelling.

To manually reset the information, press and hold the OK button on the steering wheel when viewing the **Since refuelling**.

Accumulated info

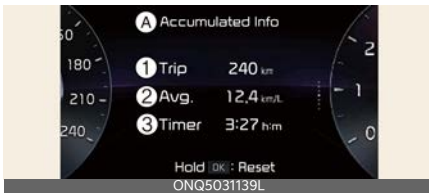

A: Accumulated info

- 1 Accumulated trip distance
- 2 Average fuel efficiency
- 3 Total driving time

The information is accumulated starting from the last reset.

To manually reset the information, press and hold the OK button on the steering wheel when viewing the **Accumulated Info**.

* NOTICE

- The average fuel economy is not displayed for more accurate calculation if the vehicle does not drive more than 10 seconds or approximately 50 m (0.03 miles) since the vehicle is in ON position.
- Fuel efficiency is calculated after the vehicle has run for more than 300 metres.
- The information will be accumulated even if the engine is running and the vehicle is not in motion.

Digital speedometer



Indicates the speed of the vehicle.

Driving force distribution (AWD) (if equipped)



The distribution status of the driving power of the front and rear wheels are displayed.

For more details, refer to "All Wheel Drive (AWD) system (if equipped)" on page 6-40.

Turn By Turn (TBT) mode

This mode displays the Navigation status.

Information mode

Tyre pressure



A: Low tyre pressure

Information related to tyre pressure.

Refer to "Tyre Pressure Monitoring System (TPMS) malfunction indicator" on page 8-10.

Master warning mode



This mode informs you of the following situations:

- Driver assistance system malfunction, limitation or radar/camera blockage
- LED headlamp malfunction
- Lamp malfunction
- TPMS failure, low tyre pressure, etc.

At this time, the Master warning light () will appear. If the warning situation is solved, the master warning light will be turned off and the Master Warning icon will disappear.

Service Interval

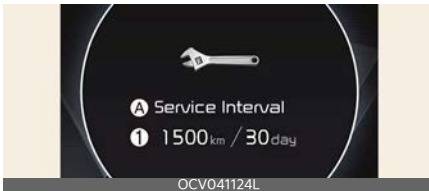

A: Service Interval

1 Service interval schedule

It calculates and displays when you need a scheduled maintenance service (mileage or days).

To reset the service interval, select **Settings** → **Vehicle** → **Cluster** → **Service Interval** → **Reset**.

* NOTICE

- If the remaining mileage or time reaches 1,500 km (900 miles) or 30 days, the message **Service in** is displayed for several seconds each time you set the vehicle to the ON position.
- If you do not have your vehicle serviced according to the already inputted service interval, **Service required** message is displayed for several seconds each time you set the vehicle to the ON position.
- If any of the following conditions occurs, the mileage and days may be incorrect.
 - The battery cable is disconnected.
 - The battery is discharged.

User settings mode

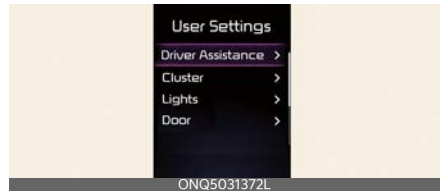

In this mode, you can change the settings of the instrument cluster, doors, lights, etc.

* The information provided may differ depending on which functions are applicable to your vehicle.

1. Driver Assistance (if equipped)

| Items | Explanation |
|--------------------------|---|
| Speed Limit | <ul style="list-style-type: none"> Speed Limit Offset Speed Limit Assist/Speed Assist Warning/Off |
| Warning timing | <ul style="list-style-type: none"> Normal/Late |
| Warning methods | <ul style="list-style-type: none"> Warning volume |
| Haptic Warning | <ul style="list-style-type: none"> Activate/Deactivate |
| Driver Attention Warning | <ul style="list-style-type: none"> Leading vehicle departure alert Inattentive driving warning |
| Forward safety | <ul style="list-style-type: none"> Active Assist/Warning Only/Off |
| Lane safety | <ul style="list-style-type: none"> Lane Keeping Assist/Lane Departure Warning/Off |
| Blind-spot safety | <ul style="list-style-type: none"> SEW (Safe Exit Warning) Active assist/Warning only/Off |
| Parking safety | <ul style="list-style-type: none"> Parking Distance Warning Auto On Rear Cross-Traffic Safety |

2. Cluster (if equipped)

| Items | Explanation |
|-------------------------------|---|
| Theme Selection | <ul style="list-style-type: none"> Theme A/Theme B/Theme C/Dynamic |
| Wiper/Lights Display | Activate |
| Traffic Signs | Activate |
| Icy Road Warning | Activate |
| Cluster Voice Guidance Volume | <ul style="list-style-type: none"> 0~3 Level |
| Welcome Sound | Activate |

3. Lights (if equipped)

| Items | Explanation |
|-----------------------|---|
| Illumination | <ul style="list-style-type: none"> 1~20 Level |
| One Touch Turn Signal | <ul style="list-style-type: none"> Off/3/5/7 Flashes |
| Ambient Brightness | <ul style="list-style-type: none"> Off/1/2/3/4 |
| Ambient Light Colour | 8 colours |
| Headlight Delay | Activate |
| High Beam Assist | Activate |

4. Door (if equipped)

| Items | Explanation |
|-------------------------------------|--|
| Automatically Lock | <ul style="list-style-type: none"> Enable on shift/Enable on speed/Off |
| Automatically Unlock | <ul style="list-style-type: none"> On shift to P/Vehicle Off/On key out (if equipped)/Off |
| Power Tailgate | Activate |
| Power Tailgate Opening Speed | <ul style="list-style-type: none"> Fast/Normal |
| Power Tailgate Opening Height | <ul style="list-style-type: none"> Full open/Level 3/Level 2/Level 1/User Height Setting |
| Smart Tailgate | Activate |
| Remote Window Control (if equipped) | Activate |

* INFORMATION

• Automatically Lock

- **Enable On Shift:** All doors will be automatically unlocked when the vehicle is shifted to P (Park) to R (Reverse), N (Neutral), or D (Drive). (Activated with the vehicle ON position)
- **Enable On Speed:** All doors will be automatically locked when the vehicle speed is over 15 km/h (9 mph).

• Automatically Unlock

- **On Shift to P:** All doors will be automatically unlocked if the gear is shifted to the P (Park) position. (With the Engine ON, it is activated.)
- **Vehicle Off/On key out (if equipped):** All doors will be automatically unlocked when the ignition key is removed from the ignition switch or the ENGINE START/STOP button is set to the OFF position.

5. Convenience (if equipped)

| Items | Explanation |
|--------------------------|---|
| Seat Easy Access | • Off/Normal/Extended |
| Rear Occupant Alert | Activate |
| Service Interval | • Enable Service Interval • Adjust Interval • Reset |
| Welcome Mirror/Light | Activate |
| Wireless Charging System | Activate |
| Auto rear wiper (in R) | Activate |

6. Units

| Items | Explanation |
|--------------------|-----------------|
| Speed Unit | • km/h, MPH |
| Temperature Unit | • °C, °F |
| Fuel Economy Unit | • km/L, L/100km |
| Tyre Pressure Unit | • psi/kPa/bar |

7. Language

| Items | Explanation |
|----------|-------------|
| Language | Activate |

8. Reset

| Items | Explanation |
|-------|-------------|
| Reset | Reset |

Driver Assistance settings (infotainment system)







select **Settings** → **Vehicle** → **Driver assistance** on the infotainment system screen to set the Driver Assistance function.

- **Driver assistance**
 - **Speed limit**
 - **Warning timing**
 - **Warning methods**
 - **Haptic warning**
 - **DAW (Driver Attention Warning)**
 - **Forward safety**
 - **Lane safety**
 - **Blind-spot safety**
 - **Parking safety**

* INFORMATION

The infotainment system may change after software updates. For more information, refer to the manual provided in the infotainment system and the quick reference guide.

LCD display messages

| LCD displays | Displayed contents |
|--|--|
|  <p>ONQ5031124_2</p> | <p>Door, bonnet, tailgate, sunroof open</p> |
|  <p>OCV041126L</p> | <p>Low tyre pressure warning display A: Low tyre pressure</p> |
|  <p>ONQ5041286L</p> | <ul style="list-style-type: none"> • A: Lights • 1: • 2: • 3: AUTO • 4: OFF (O) |
|  <p>ONQ5041287L</p> | <ul style="list-style-type: none"> • A: Front Wiper • 1: OFF (O) • 2: AUTO • 3: LO (1) • 4: HI (2) |
| <p>Low washer fluid</p> | <p>The washer fluid level in the reservoir is nearly empty.</p> |
| <p>Engine overheated</p> | <p>The engine coolant temperature is above 120 °C (248 °F).</p> |
| <p>Low key battery</p> | <p>The battery of the smart key is discharged</p> |
| <p>Key not in vehicle</p> | <p>The smart key is not in the vehicle when you press the ENGINE START/STOP button</p> |
| <p>Icy road warning</p> | <p>The temperature on the outside temperature gauge is below approximately 4 °C (40 °F).</p> |
| <p>Press START button whilst turning wheel</p> | <p>The steering wheel does not unlock normally when the ENGINE START/STOP button is pressed</p> |
| <p>Steering wheel not locked</p> | <p>The steering wheel does not lock when the vehicle changes to the OFF position</p> |
| <p>Check steering wheel lock system</p> | <p>The steering wheel does not lock normally when the vehicle changes to the OFF position</p> |

| LCD displays | Displayed contents |
|--|---|
| Key not detected | The smart key is not detected when you press the ENGINE START/STOP button |
| Shift to P or N to start engine | Starting the vehicle with the gear not in the P (Park) or N (Neutral) position |
| Press brake pedal to start vehicle | The ENGINE START/STOP button changes to the ACC position twice by pressing the button repeatedly without depressing the brake pedal |
| Battery discharging due to external electrical devices | Self-discharge of the battery due to overcurrent that is generated by unauthorised electrical devices |
| Press START button again | The ENGINE START/STOP button cannot be operated due to a problem with the ENGINE START/STOP button system |
| Press START button with key | The ENGINE START/STOP button is pressed whilst the "Key not detected" warning message is displayed |
| Check BCW system | Problem with Blind-spot Collision Warning (BCW) |

*** INFORMATION**

- If there is no problem with the operation and the messages above are constantly displayed, have your vehicle inspected by a professional workshop. Kia recommends to contact an authorised Kia dealer/service partner.
- **Icy road warning**
When the following conditions occur, the warning light (including outside temperature gauge) blinks 5 times and then illuminates, and also warning chime sounds once.
- **Battery discharging due to external electrical devices**
The vehicle can detect self-discharge of the battery due to overcurrent that is generated by unauthorised electrical devices such as instrument panel camera (dash cam) mounting during parking.
If the warning continues even after external electrical devices are removed, have your vehicle inspected by a professional workshop. Kia recommends to contact an authorised Kia dealer/service partner.
- **Press START button again**

- You could start the engine by pressing the ENGINE START/STOP button once more.
- If the warning message is displayed each time you press the ENGINE START/STOP button, have the vehicle inspected by a professional workshop. Kia recommends to visit an authorised Kia dealer/service partner.

*** NOTICE**

- If the warning message is displayed in the cluster, the driving information message may not be displayed.
- To set the charging time and/or climate time, refer to a separately supplied car navigation system manual for detailed information.
- If the icy road warning appears whilst driving, you should drive more attentively and safely refraining from over-speeding, rapid acceleration, sudden braking or sharp turning, etc.

Vehicle settings (infotainment system)



1. Press the **Settings** button on the head unit of the infotainment system.
2. Select **Vehicle** and change the setting of the features.

Vehicle Settings in the infotainment system provides user options for a variety of settings including door lock/unlock features, convenience features, driver assistance settings, etc.

- **Vehicle settings**
 - **Driver assistance**
 - **Cluster**
 - **Climate**
 - **Seat**
 - **Lights**
 - **Door**
 - **Convenience**

WARNING













Do not operate the **Vehicle settings** whilst driving. This may cause distraction resulting in an accident.

















*** NOTICE**

The information provided may differ depending on which features are applicable to your vehicle.

Warning and indicator lights

Once you set the vehicle to the ON position, the symbols shown below will light up. If these symbols remain on or malfunction, we recommend having the vehicle inspected by an authorised Kia dealer/service partner.

| Symbol | Time | Notes |
|--|--------------|---|
|  | 6 seconds | The air bag warning light appears for about 6 seconds and then turns off. |
| | Continuously | <ul style="list-style-type: none"> There is a malfunction with the Safety Restraint System (SRS) air bag operation. |
|  | Continuously | Seat belt warning light informs the driver that the seat belt is not fastened. Refer to "Seat belts" on page 3-12. |
|  | 3 seconds | Parking brake & brake fluid warning light appears for approximately 3 seconds. |
| | Continuously | <ul style="list-style-type: none"> When the parking brake is applied. When the brake fluid level in the reservoir is low. |
|  | 3 seconds | The ABS warning light appears for about 3 seconds and then goes off. |
| | Continuously | <ul style="list-style-type: none"> Whenever there is a malfunction with the ABS. |
|   | Continuously | Electronic Brake Force Distribution (EBD) system warning light appears when there is a problem with the Electronic Brake Force Distribution system. |
| | 3 seconds | Electric Power Steering (EPS) warning light appears for about 3 seconds and then goes off. |
|  | Continuously | <ul style="list-style-type: none"> Whenever there is a malfunction with the electric power steering. |
| | 3 seconds | Charging system warning light appears for approximately 3 seconds and then goes off. |
|  | Continuously | <ul style="list-style-type: none"> Whenever there is a malfunction with either the alternator or electrical charging system. |
| | Continuously | Master warning light appears when there is a malfunction in various vehicle functions. To identify the details of the warning, refer to the LCD display warning message. |
|  | 3 seconds | Malfunction Indicator Lamp (MIL) appears for approximately 3 seconds and then goes off. |
| | Continuously | <ul style="list-style-type: none"> Whenever there is a malfunction with either the emission control system or the engine or the vehicle powertrain. |
|  | Continuously | Engine oil pressure warning light appears until the engine is started. <ul style="list-style-type: none"> When the engine oil pressure is low. |
| | Continuously | <ul style="list-style-type: none"> When the fuel tank is nearly empty. |
|  | Continuously | <ul style="list-style-type: none"> When there is a malfunction with Diesel Particulate Filter (DPF)/Petrol Particulate Filter (PPF) system. |
| | Continuously | <ul style="list-style-type: none"> When the urea solution tank is nearly empty. |
|  | Continuously | <ul style="list-style-type: none"> When the engine is being preheated. The engine can be started after the glow indicator light goes off. |
| | 3 seconds | Fuel filter warning light appears for approximately 3 seconds and then goes off. (For diesel engine) |
|  | Continuously | <ul style="list-style-type: none"> When water has accumulated inside the fuel filter. |
| | 3 seconds | Electronic Parking Brake EPB warning light appears for about 3 seconds and then goes off. |
| EPB | Continuously | <ul style="list-style-type: none"> Whenever there is a malfunction with the Electronic Parking Brake EPB |
| | 3 seconds | Low tyre pressure warning light appears for approximately 3 seconds and then goes off. |
|  | Continuously | <ul style="list-style-type: none"> When one or more of your tyres are significantly underinflated. |
| | Blinking | <ul style="list-style-type: none"> When there is a malfunction with the TPMS. Refer to "Tyre Pressure Monitoring System (TPMS) (if equipped)" on page 8-8. |

| Symbol | Time | Notes |
|---|--------------|--|
|  | 3 seconds | Forward Safety warning light appears for approximately 3 seconds and then goes off. |
| | Continuously | <ul style="list-style-type: none"> Whenever there is a malfunction with Forward Collision-Avoidance Assist. Refer to "Forward Collision-Avoidance Assist (FCA) (Front Camera Only) (if equipped)" on page 7-5. and "Forward Collision-Avoidance Assist (FCA) (Sensor Fusion) (if equipped)" on page 7-14 |
|  | Continuously | Lane safety indicator light appears: <ul style="list-style-type: none"> Green: When Lane Keeping Assist operating conditions are satisfied. Gray: When Lane Keeping Assist operating conditions are not satisfied. Yellow: Whenever there is a malfunction with Lane Keeping Assist. Refer to "Lane Keeping Assist (LKA) (if equipped)" on page 7-26. |
|  | Continuously | Lane Following Assist indicator light appears: <ul style="list-style-type: none"> Green: When Lane Following Assist is activated Gray: When Lane Following Assist operating conditions are not satisfied. Refer to "Lane Following Assist (LFA) (if equipped)" on page 7-83. |
|  | Continuously | When 4WD Lock Mode is activated. Refer to "All Wheel Drive (AWD) system (if equipped)" on page 6-40. |
|  | 3 seconds | LED headlight warning light appears for approximately 3 seconds and then goes off. |
| | Continuously | <ul style="list-style-type: none"> Whenever there is a malfunction with the LED headlight. |
| | Blinking | <ul style="list-style-type: none"> Whenever there is a malfunction with a LED headlight related part. |
|  | Continuously | Icy road warning light and outside temperature gauge blinks and then appears. Also, the warning chime sounds 1 time. |
|  | 3 seconds | Electronic Stability Control indicator light appears for about 3 seconds and then goes off. |
| | Continuously | <ul style="list-style-type: none"> Whenever there is a malfunction with ESC system. |
|  | 3 seconds | The ESC OFF indicator light appears for approximately 3 seconds and then goes off. |
| | Continuously | <ul style="list-style-type: none"> When you deactivate ESC system by pressing the ESC OFF button. Refer to "Electronic Stability Control (ESC) (if equipped)" on page 6-33. |
|  | Continuously | When the vehicle detects the key in the vehicle in ACC/ON position |
| | Blinking | When the key is not in the vehicle Whenever there is a malfunction with the immobiliser system. |
| | 2 seconds | When the vehicle cannot detect the key. |
|  | Blinks | When the turn signal light is on |
|  | Continuously | When high-beam headlamps are on. |
|  | Continuously | When low-beam headlamps are on. |
|  | Continuously | When the light switch is in the ON position |
|  | Continuously | When the front fog lights are on. |
|  | Continuously | When the rear fog lights are on. |
|  | Continuously | <ul style="list-style-type: none"> When High Beam Assist (HBA) is activated. Refer to "High Beam Assist (HBA) (if equipped)" on page 4-63. |
|  | 3 seconds | Downhill Brake Control (DBC) indicator light appears for about 3 seconds and then goes off. |
| | Continuously | <ul style="list-style-type: none"> When you activate the system by pressing the DBC button. Refer to "Downhill Brake Control (DBC) (if equipped)" on page 6-34. |
| AUTO HOLD | Continuously | When AUTO HOLD is activated. |

| Symbol | Time | Notes |
|-----------------------|--------------|--|
| SOS | 3 seconds | SOS warning light appears for approximately 3 seconds and then goes off. |
| | Continuously | <ul style="list-style-type: none"> Whenever there is a malfunction with the eCall system. Refer to "ERA-GLONASS emergency call (if equipped)" on page 8-24. |
| ECO SPORT SMART | Continuously | When you select each mode as drive mode. Refer to "Drive mode integrated control system" on page 6-38. |

*** INFORMATION**

• **Dual-diagonal braking system**



Your vehicle is equipped with dual diagonal braking systems. This means you still have braking on two wheels even if one of the dual systems should fail.

With only one of the dual systems working, more than normal pedal travel and greater pedal pressure are required to stop the vehicle. Also, the vehicle will not stop in as short a distance with only a portion of the brake system working.



• **Engine oil pressure warning light  - When the engine oil pressure is low**

- Drive carefully to the nearest safe location and stop your vehicle.
- Turn the engine off and check the engine oil level (For more details, refer to "Engine oil" on page 9-35). If the level is low, add oil as required.
- If the engine oil pressure warning light () remains on after adding oil or if oil is not available, have the vehicle inspected by a professional workshop as soon as possible. Kia recommends to visit an authorised Kia dealer/service partner. Continued driving with the warning light on may cause engine failure.







• **Exhaust system (DPF) warning light **

- If there is a malfunction in the diesel particulate filter, the Exhaust system (DPF) warning light () will appear and "Keep driving to regenerate exhaust filter" message will be displayed on the cluster. Safely drive at 60 km/h (40 mph), above 2nd gear, engine RPM between approximately 1,500~2,500 rpm for approximately over 25 minutes. The Exhaust system (DPF) warning light will turn off.
 - If the warning light does not turn off, the DPF warning light will blink and "Check exhaust system" will be displayed on the cluster. In this case, have your vehicle checked by a professional workshop. Kia recommends to visit an authorised Kia dealer/service partner.
- **Exhaust system (PPF) warning light **
- Exhaust system (PPF) warning light () may turn off after the vehicle speed is over approximately 80 km/h (50 mph), or above 3rd gear with 1,500~4,000 rpm for a certain time (approximately 30 minutes).
 - If this warning light blinks in spite of the procedure (at this time the LCD warning message will be displayed), have the system checked by a professional workshop. Kia recommends to visit an authorised Kia dealer/service partner.

⚠ WARNING

- **Parking brake & brake fluid warning light** 
 - Driving the vehicle with a warning light ON is dangerous. If the parking brake & brake fluid warning light appears with the parking brake released, it indicates that the brake fluid level is low.
 - In this case, have the vehicle inspected by a professional workshop. Kia recommends visiting an authorised Kia dealer/service partner.
- **Electronic Brake force Distribution (EBD) system warning light**  
 - When both ABS and parking brake & brake fluid warning lights are on, the brake system will not work normally and you may experience an unexpected and dangerous situation during sudden braking.
 - In this case, avoid high speed driving and abrupt braking. We recommend you have the vehicle inspected by an authorised Kia dealer/service partner as soon as possible.
- **Safe stopping**
 - The TPMS cannot alert you to severe and sudden tyre damage caused by external factors.
 - If you notice any vehicle instability, immediately take your foot off the accelerator pedal, apply the brakes gradually with light force, and slowly move to a safe position off the road.

⚠ CAUTION

- **Low fuel level warning light** 
 - Driving with the Low fuel level warning light on or with the fuel level below "E" can cause the engine to misfire.
- **Malfunction Indicator Lamp (MIL)** 
 - If the Malfunction Indicator Lamp (MIL) appears, potential catalytic converter damage is possible which could result in loss of engine power. In this case, have the vehicle inspected by a professional workshop. Kia recommends to visit an authorised Kia dealer/service partner.
- **Fuel filter warning light** 
 - When the fuel filter warning light appears, engine power (vehicle speed & idle speed) may decrease.
 - If you keep driving with the fuel filter warning light  on, engine parts (injector, common rail, high pressure fuel pump) may be damaged. If this occurs, have the vehicle inspected by a professional workshop as soon as possible. Kia recommends to visit an authorised Kia dealer/service partner.
- **Exhaust system warning light** 
 - If you continue to drive with the exhaust system warning light  blinking for a long time, the system can be damaged and fuel consumption can worsen.

*** NOTICE**

- Make sure that all warning lights are OFF after starting the vehicle. If any

light is still ON, this indicates a situation that needs attention.

- **Malfunction Indicator Lamp (MIL)**



- Driving with the Malfunction Indicator Lamp (MIL) on may cause damage to the emission control system which could affect drivability and/or fuel economy.
- If the enhanced engine protection system becomes activated due to lack of engine oil, engine power will be limited. If such condition continues repeatedly, the Malfunction Indicator Lamp (MIL) will appear.

- **Electronic Brake force Distribution (EBD) system warning light** 

- When the ABS warning light is on or both ABS and Parking Brake & Brake Fluid warning lights are on, the speedometer, odometer, or trip-meter may not work. Also, the EPS warning light may appear and the steering effort may increase or decrease.
- In this case, avoid high speed driving and abrupt braking. We recommend you have the vehicle inspected by an authorised Kia dealer/service partner as soon as possible.

- **Electronic Parking Brake warning light EPB**

- The Electronic Parking Brake warning light (**EPB**) may appear when the Electronic Stability Control (ESC) indicator light comes on to indicate that the ESC is not working properly (This does not indicate malfunction of the EPB).

- Continuous driving with the LED Headlight warning light on or blinking can reduce LED headlight life.

- If the icy road warning light appears whilst driving, you should drive more attentively and safely refraining from over-speeding, rapid acceleration, sudden braking or sharp turning, etc.

- **Engine oil pressure warning light**



- When engine oil pressure decreases due to insufficient engine oil, etc., the engine oil pressure warning light () will appear.
- The enhanced engine protection system which limits engine power will be activated. If the engine oil pressure is restored, the engine oil pressure warning light and the enhanced engine protection system will turn off.
- For Smartstream G2.0/Smartstream G2.5 GDi engine, when the engine oil pressure is restored, the warning light and the enhanced engine protection system will turn off after the engine is restarted.

Lighting

Lighting functions

Battery saver function

The purpose of this feature is to prevent the battery from being discharged.

The system automatically shuts off the parking lights after the engine is off and the driver's door is opened.

However, the position lamps stay ON even when the driver-side door is opened if the light switch is operated after the engine is turned off.

If necessary, to keep the lamps on turn the position lamps OFF and ON again using the headlamp switch on the steering column after the engine is turned off.

CAUTION

To prevent the battery from being discharged, do not leave the headlight and interior light on for a prolonged time whilst the engine is not running.

Headlamp escort function (if equipped)

Operation

1. The headlamps remain on for approximately 5 minutes.
2. The headlamps turn off after 15 seconds.
3. To turn the headlamps OFF:
 - Press the lock button on the key 2 times
 - Turn the headlamp switch to OFF position

Operating condition(s)

- The vehicle is in ACC or OFF position with the headlamps ON
- The driver's door is opened and closed

Daytime Running Light (DRL)

Operating condition(s)

- The vehicle is in ON position
- The headlamp switch is in OFF position
- Parking brake is disengaged

INFORMATION

If necessary, to keep the position lamp on when the vehicle is turned off, perform the following:

- Open the driver's side door.
 - Turn the position lamp ON.
-

Lighting controls

Operating lights

Type A/B



ONQ5041275L



ONQ5EP041275R



ONQ5EP041408R

Operation

- 1 OFF (O)
- 2 AUTO (if equipped)
 - Tailamps and headlamps will turn ON or OFF automatically depending on the amount of light outside the vehicle.
- 3 Position & Taillamp (D Q)
- 4 Low beam (E D)

* INFORMATION

The vehicle must be in the ON position to turn on the headlights.

▲ CAUTION

- Never place anything over the sensor located on the instrument panel as

this will ensure better auto-light system control.

- Don't clean the sensor using a window cleaner, the cleaner may leave a light film which could interfere with sensor operation.
- If your vehicle has window tint or other types of metallic coating on the front windscreen, the Auto light system may not work properly.

Operating turn signals



ONQ5041276L



ONQ5EP041276R



ONQ5EP041430R

Operation

- Move the lever up or down (A).

* NOTICE

If an indicator flash is abnormally quick or slow, a bulb may be burned out or have a poor electrical connection in the circuit.

One-touch lane change function

Operation

1. Move the turn signal lever up or down (B).
2. Release the lever.

* INFORMATION

- You can activate or deactivate the One Touch Turn Signal function or choose the number of blinking (3, 5, or 7) by selecting "User Settings → Lights → One Touch Turn signal".
- If an indicator stays on and does not flash or if it flashes abnormally, one of the turn signal bulbs may be burned out and will require replacement.

Operating fog lights (if equipped)

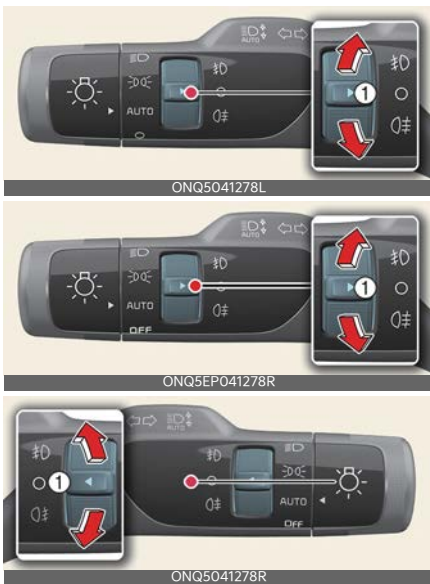

Operation

1. Turn the front fog light switch (1) to the dedicated position.
2. Front: (☹D)/Rear: (☹E)

Operating condition(s)

- The headlamp is turned ON.

⚠ CAUTION

When in operation, the fog lights consume large amounts of vehicle electrical power. Only use the fog lights when visibility is poor.

Operating high beam

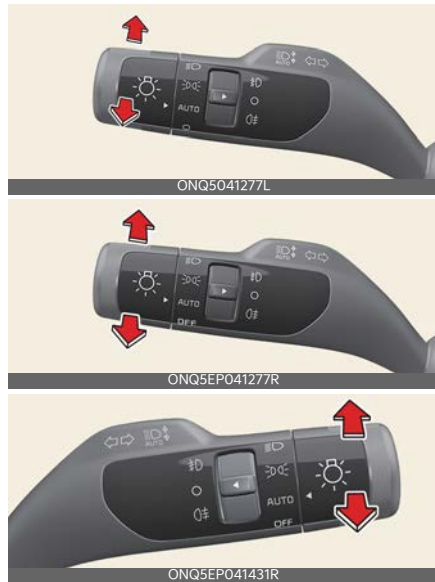

To flash the headlights (☹D):

- Pull the lever towards you.

Operation

- Push the lever to use high beam.

⚠ WARNING

Do not use high beam when there are other vehicles. Using high beam could obstruct the other driver's vision.

High Beam Assist (HBA) (if equipped)



High Beam Assist is a function that automatically adjusts the headlamp range (switches between high beam and low beam) depending on the brightness of detected vehicles and certain road conditions.

Detecting sensor

Front view camera



The front view camera is used as a detecting sensor to detect ambient light and brightness whilst driving. Refer to the picture above for the detailed location of the detecting sensor.

⚠ CAUTION

Always keep the front view camera in good condition to maintain optimal performance of High Beam Assist.

For more details on the precautions of the front view camera, refer to "Forward Collision-Avoidance Assist (FCA) (Front Camera Only) (if equipped)" on page 7-5 and "Forward Collision-Avoidance Assist (FCA) (Sensor Fusion) (if equipped)" on page 7-14.

4

High Beam Assist Setting

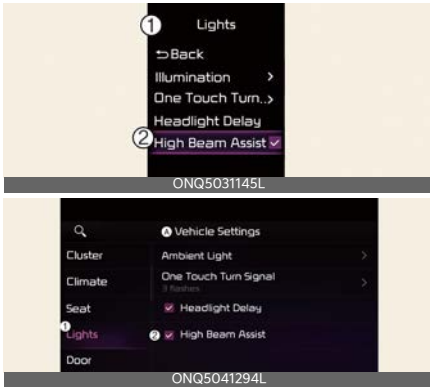

A: Vehicle Settings

1 Lights

2 High Beam Assist

With the vehicle in the ON position, select **Settings** → **Vehicle** → **Lights** → **High Beam Assist** from the Settings menu to turn on High Beam Assist function.

⚠ WARNING

For your safety, change the Settings after parking the vehicle at a safe location.

High Beam Assist operation

- After selecting **HBA (High Beam Assist)** in the **Settings** menu, High Beam Assist will operate by following the procedure below.
 - Place the headlamp switch in the AUTO position and push the headlamp lever towards the instrument cluster. The High Beam Assist (HBA) indicator light will appear on the cluster and the function will be enabled.
 - When the function is enabled, high beam will turn on when vehicle

speed is above 40 km/h (25 mph). The High Beam (HBA) indicator light will appear on the cluster. When vehicle speed is below 25 km/h (15 mph), high beam will not turn on and the High Beam Assist (HBA) indicator light will appear white on the cluster.

- When High Beam Assist is operating, if the headlamp lever or switch is used, the function operates as follow:
 - If the headlamp lever is pulled towards you when the high beam is off, the high beam will turn on. When you let go of the headlamp lever, High Beam Assist will turn on again.
 - If the headlamp lever is pulled towards you when the high beam is on, the low beam will turn on and High Beam Assist will be cancelled.
 - If you push the light switch towards the instrument cluster, high beam is turned on and High Beam Assist is released.
 - If the headlamp switch is placed from AUTO to another position (headlamp/position/off), High Beam Assist will turn off and the corresponding lamp will turn on.
- When High Beam Assist is operating, high beam switches to low beam if any of the following conditions occur:
 - When the headlamp of an oncoming vehicle is detected.
 - When the tail lamp of a vehicle in front is detected.
 - When the headlamp or tail lamp of a motorcycle or a bicycle is detected.
 - When the surrounding ambient light is bright enough that high beams are not required.

- When streetlights or other lights are detected.

High Beam Assist Malfunction and limitations

High Beam Assist Malfunction

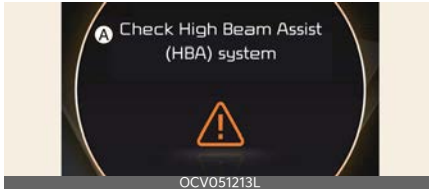

A: Check High Beam Assist (HBA) system

When High Beam Assist is not working properly, the warning message will appear and warning light (⚠) will appear on the cluster. We recommend that you have your vehicle inspected by an authorised Kia dealer/service partner.

Limitations of High Beam Assist

- Light from a vehicle is not detected because of lamp damage, or because it is hidden from sight, etc.
- Headlamp of a vehicle is covered with dust, snow or water.
- A vehicle's headlamps are off but the fog lamps are on and etc.
- There is a lamp that has a similar shape as a vehicle's lamp.
- Headlamps have been damaged or not repaired properly.
- Headlamps are not aimed properly.
- Driving on a narrow curved road, rough road, uphill or downhill.
- Vehicle in front is partially visible on a crossroad or curved road.
- There is a traffic light, reflecting sign, flashing sign or mirror ahead.
- There is a temporary reflector or flash ahead (construction area).

- The road conditions are bad such as being wet, iced or covered with snow.
- A vehicle suddenly appears from a curve.
- The vehicle is tilted from a flat tyre or is being towed.
- Light from a vehicle is not detected because of exhaust fume, smoke, fog, snow, etc.

* NOTICE

- Depending on the instrument cluster specifications or theme, images or colours may be displayed differently.
- For more details on the limitations of the front view camera, refer to "Forward Collision-Avoidance Assist (FCA) (Front Camera Only) (if equipped)" on page 7-5 and "Forward Collision-Avoidance Assist (FCA) (Sensor Fusion) (if equipped)" on page 7-14.

⚠ WARNING

- At times, High Beam Assist may not work properly. The function is for your convenience only. It is the responsibility of the driver for safe driving practices and always check the road conditions for your safety.
- When High Beam Assist does not operate normally, change the headlamp position manually between high beam and low beam.

Headlamp levelling adjustment switch (if equipped)



ONQ5031036R

Operation

1. The higher the number of the switch position, the lower the headlamp beam level.
2. Always keep the headlamp beam at the proper levelling position, or headlamps may dazzle other road users.

| Loading condition | Switch position |
|--|-----------------|
| Driver only | 0 |
| Driver + Front passenger | 0 |
| Full passengers (including driver) | 1 |
| Full passengers (including driver) + Maximum permissible loading | 2 |
| Driver + Maximum permissible loading | 3 |

Wipers and washers

Wipers

Controlling wipers



ONQ5031040L



ONQ5032543L



ONQ5031040R

Operation

- 1 Front wiper speed control
 - MIST/1x: Single wipe
 - OFF/O: Off
 - INT: Intermittent wipe
 - AUTO*: Auto control wipe
 - LO/1: Low wiper speed
 - HI/2: High wiper speed
- 2 Wash with brief wipes
- 3 Rear wiper speed control
 - HI/2: Continuous wipe
 - LO/1: Intermittent wipe
 - OFF/O: Off

*: if equipped

*** NOTICE**

If there is heavy accumulation of snow or ice on the windscreen, defrost the windscreen for about 10 minutes, or until the snow and/or ice is removed before using the windscreen wipers to ensure proper operation. If you do not remove the snow and/or ice before using the wiper and washer, it may damage the wiper and washer system.

*** INFORMATION**

If you operate the wipers whilst driving on snowy roads, the wipers may stop due to snow buildup on your windscreen. This is normal and not a failure because it is one of our safety features to prevent vehicle accidents and wiper damage from overloading the wiper motor. If the wipers stop, remove snow accumulated on the top or bottom of windscreen before using them.

Controlling wiper automatically (if equipped)



- A: Rain sensor
- B: Wiper speed control switch

Operation



1. The rain sensor (A) senses the amount of rainfall and adjusts the wiper speed to a proper interval.
2. Turn the speed control switch (B) to adjust the wiper speed.

⚠ CAUTION

- When the ignition switch or ENGINE START/STOP button is ON and the windscreen wiper switch is placed in the AUTO mode, use caution in the following situations to avoid any injury to the hands or other parts of the body:
 - Do not touch the upper end of the windscreen glass facing the rain sensor.
 - Do not wipe the upper end of the windscreen glass with a damp or wet cloth.
 - Do not put pressure on the windscreen glass.
- When washing the vehicle, set the wiper switch in the OFF (O) position to stop the auto wiper operation. The wiper may operate and be damaged if the switch is set in the AUTO mode whilst washing the vehicle.
- Do not remove the sensor cover located on the upper end of the passenger side windscreen glass. Dam-

age to system parts could occur and may not be covered by your vehicle warranty.

- When starting the vehicle in winter, set the wiper switch in the OFF (O) position. Otherwise, wipers may operate and ice may damage the windscreen wiper blades. Always remove all snow and ice and defrost the windscreen properly prior to operating the windscreen wipers.
- When tinting the windscreen, be careful of any fluid getting into the sensor located in the top centre of the front windscreen. It may damage the related parts.

2. To spray the washer fluid on the windscreen:
 - Front windscreen (1): Pull the lever gently toward you. 
 - Rear windscreen (2): Push the lever gently away from you. 
3. Repeat the step 2 several times.

⚠ WARNING

Do not use the washer in freezing temperatures without first warming the windscreen with the defrosters; the washer solution could freeze on the windscreen and obscure your vision.

⚠ CAUTION

- To prevent possible damage to the washer pump, do not operate the washer when the fluid reservoir is empty.
- To prevent possible damage to the wipers or windscreen, do not operate the wipers when the windscreen is dry.
- To prevent damage to the wiper blades, do not use petrol, kerosene, paint thinner, or other solvents on or near them.
- To prevent damage to the wiper arms and other components, do not attempt to move the wipers manually.
- To prevent possible damage to the wipers and washer system, use anti-freezing washer fluids in the winter season or cold weather.

Washers

Controlling washers

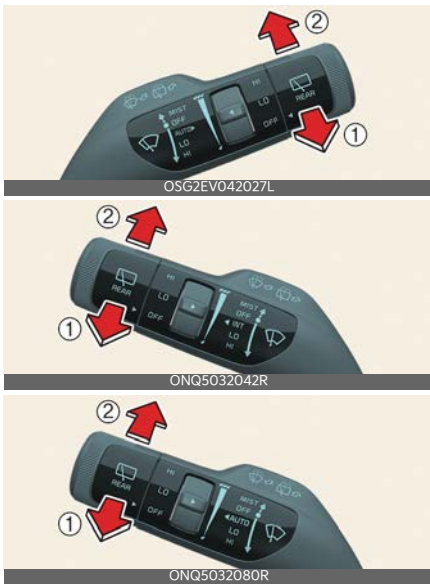

Operation

1. Move the wiper speed control switch to OFF (O) position.

Heated washer nozzle (if equipped)

The heated washer nozzle function defreezes the washer nozzles in freezing weather.

The heated washer nozzle will turn on and off automatically when the ignition switch or ENGINE START/STOP button is in ON position or when the engine is running in following conditions:

- Turns ON when the outside temperature is below 5 °C, and OFF when it is over 10 °C.
- The washer fluid defreezing speed may be slower when the ignition switch or ENGINE START/STOP button is in ON position, than compared to when the engine is running.
- When the ignition switch or ENGINE START/STOP button is in ON position, after approximately 20 minutes of operation, the system will turn off automatically to prevent possible battery discharge.
- After the engine is running, the washer fluid will defrost approximately after 5 ~ 10 minutes.
- If the engine has been started within the operating temperature, the heated nozzle remains ON even approximately after 20 minutes.

* NOTICE

The heated washer nozzle may not function properly under following conditions:

- The washer fluid in the washer reservoir is frozen.
- Outside temperature sensor is malfunctioning.

Welcome system

The surroundings or the interior will be illuminated when the driver approaches or exits the vehicle.

Illuminating functions

Door handle lamp (if equipped)



Operation

- Door handle lamp will turn on for approximately 15 seconds.

Operating condition(s)

- All the doors (and tailgate) are closed and locked.

Headlamp escort function

Operation

- Headlamps and tailamps will turn on.
 - For approximately 5 minutes.
 - After approximately 15 seconds.

Operating condition(s)

- Vehicle is in the ACC position.
- The driver's door is opened and closed.

Interior illumination

Operation

- The room lamp will turn on.
 - For approximately 30 seconds.

Operating condition(s)

- Map lamp switch is in DOOR mode.
- All the doors (and tailgate) are closed and locked.

Interior lights

Automatic turn off function

Operation

- The interior lights will turn off.
 - After approximately 5 minutes.

Operating condition(s)

- The vehicle is in the OFF position.
- The lights are in the ON position.

⚠ WARNING

Do not use the interior lights when driving in the dark. Accidents could happen because the view may be obscured by interior lights.

⚠ CAUTION

Do not use the interior lights for extended periods when the engine is not running. It may cause battery discharge.

Map lamp



Type A



Type B



Operation

- Press the lamp (1) to turn the map lamp ON.
-  (2): DOOR mode
-  (3): Front and rear room lamps on and off.

* INFORMATION

- The map lamp and room lamp come on approximately 30 seconds.
 - When a door is opened.
 - When doors are unlocked with a smart key as long as the doors are not opened.
- The map lamp and room lamp will stay on
 - If a door is opened with the ENGINE START/STOP button in the ACC or OFF position. (5 minutes)
 - If the door is opened with the ENGINE START/STOP button in the ON position. (continuously)
- The map lamp and room lamp will go out
 - If the vehicle is changed to the ON position or all doors are locked. (immediately)

* NOTICE

The DOOR mode and ROOM mode can not be selected at a time.

Room lamp (if equipped)



Operation

- Press the switch to turn the room lamp on and off.

Personal lamp (if equipped)



Operation

- Press the switch to turn the personal lamp on and off.

Luggage room lamp



Operation

- Open the tailgate. The lamp will turn on.

4

Vanity mirror lamp (if equipped)



Operation

- ☀️: The lamp will turn on if this button is pressed.
- : The lamp will turn off if this button is pressed.

* NOTICE

To prevent unnecessary charging system drain, close the vanity mirror cover after using the mirror.

Glove box lamp



Operation

- The glove box lamp comes on when the glove box is opened.

* NOTICE

To prevent unnecessary charging system drain, close the glove box securely after using the glove box.

Climate control system

Climate control system components

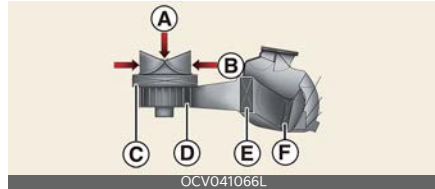

- A: Outside air
- B: Recirculated air
- C: Climate control air filter
- D: Blower
- E: Evaporator core
- F: Heater core

The climate control air filter installed behind the glove box filters the dust or other pollutants that come into the vehicle from the outside through the heating and air conditioning system.

If dust or other pollutants accumulate in the filter over a period of time, the air flow from the air vents may decrease. This leads to moisture accumulating on the inside of the windscreen even when the outside (fresh) air position is selected.

If this happens, have the climate control air filter replaced by a professional workshop. Kia recommends to visit an authorised Kia dealer/service partner.

⚠️ CAUTION

- Excessive air conditioning use**
When using the air conditioning system, monitor the temperature gauge closely whilst driving up hills or in heavy traffic when outside temperatures are high. Air conditioning system operation may cause vehicle over-

heating. Continue to use the blower fan but turn the air conditioning system off if the temperature gauge indicates vehicle overheating.

- The air conditioning system should only be used with the windows and sunroof closed to prevent condensation inside the vehicle that may cause damage to electrical components.

*** NOTICE**

- Replace the filter according to the maintenance schedule. If the vehicle is being driven in severe conditions such as dusty or rough roads, more frequent air conditioner filter inspections and changes are required.
- When the air flow rate suddenly decreases, have the system checked by a professional workshop. Kia recommends to visit an authorised Kia dealer/service partner.

Air conditioning refrigerant label

Example Type A

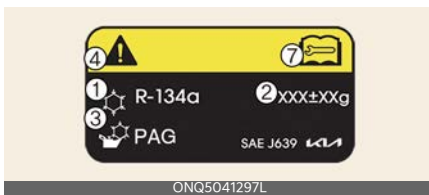

Example Type B



- 1 Classification of refrigerant

- 2 Amount of refrigerant
- 3 Classification of Compressor Lubricant
- 4 Caution
- 5 Flammable Refrigerant
- 6 Registered technician to service Air Conditioning system
- 7 Service manual

You can find out which air conditioning refrigerant is applied your vehicle at the label inside of the engine compartment. Refer to "Refrigerant label" on page 10-11 for more detail.

*** INFORMATION**

When the amount of refrigerant is low, the performance of the air conditioning is reduced. Overfilling also has a negative impact on the air conditioning system.

If abnormal operation is found, have the system inspected by a professional workshop. Kia recommends to visit an authorised Kia dealer/service partner.

⚠ WARNING

- **Vehicles equipped with R-134a**



Because the refrigerant is at very high pressure, the air conditioning system should only be serviced by trained and certified technicians. It is important that the correct type and amount of oil and refrigerant is used.

Otherwise, it may cause damage to the vehicle and personal injury.

- **Vehicles equipped with R-1234yf***



Since the refrigerant is mildly flammable and operated at high pressure, the air conditioning system should only be serviced by trained and certified technicians.

It is important that the correct type and amount of oil and refrigerant are used. All refrigerants should be reclaimed with proper equipment. Venting refrigerants directly to the atmosphere is harmful to individuals and environment. Failure to heed these warnings can lead to serious injuries.

⚠ CAUTION**AC repair**

It is important that the correct type and amount of oil and refrigerant is used, otherwise, damage to the vehicle may occur. To prevent damage, the air conditioning system in your vehicle should only be serviced by trained and certified Kia technicians.

Operating climate control system

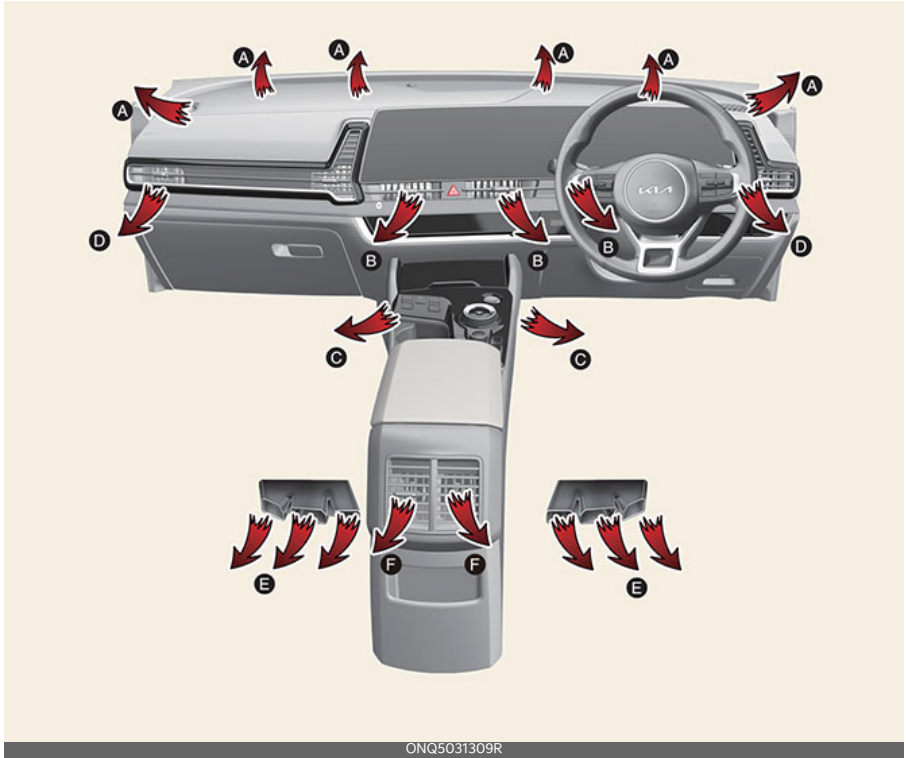

4

| Mode | Operation | Air flow |
|------|---|---------------|
| | Air flow is directed toward the upper body and face. | B, D, F |
| | Air flow is directed towards the face and the floor. | B, C, D, E, F |
| | Most of the air flow is directed to the floor, with a small amount of air directed to the windscreen, side-window defrosters, and side air vents. | A, C, D, E, F |
| | Most of the air flow is directed to the floor and the windscreen, with a small amount directed to the side-window defrosters and side air vents. | A, C, D, E, F |
| | Most of the air flow is directed to the windscreen, with a small amount of air directed to the side-window defrosters and side air vents. | A, D |

Operation

1. Start the vehicle.
2. Set the mode-selection buttons as desired. To improve the effectiveness of heating and cooling:
 - Heating: (🔥)
 - Cooling: (❄️)
3. Set the temperature control to the desired temperature level.
4. Set the air intake control to the position for outside (fresh) air if required.
5. Set the position of the fan speed control so that it runs at the desired speed.
6. If desired, turn the air conditioning ON with the temperature set high in order to dehumidify the air before it enters into the cabin.
If the windscreen fogs up, select the Front Defrost (👤) mode.

Selecting air flow modes

Manual type



Automatic type (A/B)



Operation

- Select the direction of the air flow through the ventilation system.

The air flow outlet ports are switched in the following sequence:



Controlling air intake

With outside air position button

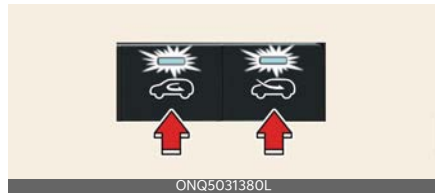

Without outside air position button



Operation

- Select the outside (fresh) air position or recirculated air position.
- Outside (fresh) air position: Air enters the vehicle from outside. For the types without the outside air position button, the indicator light will turn off.
- Recirculated air position: Air from the passenger compartment will be drawn through the heating system. For the types without the outside air position button, the indicator light will turn on.

⚠️ WARNING

- Continuously using the climate control system in the recirculated air position may allow humidity to increase inside the vehicle which may fog the glass and obscure visibility.

- Do not sleep in a vehicle with the air conditioning or heating system on. It may cause serious harm or death due to a drop in the oxygen level and/or body temperature.
- Continuously using the climate control system in the recirculated air position can cause drowsiness or sleepiness, and loss of vehicle control. Set the air intake control to the outside (fresh) air position as much as possible whilst driving.

*** NOTICE**

Prolonged operation of the heater in the recirculated air position (without air conditioning selected) may cause fogging of the windscreen and side windows and make the air in the passenger compartment stale. In addition, prolonged use of the air conditioning with the re circulated air position selected will result in excessively dry air in the passenger compartment.

Controlling instrument panel vents

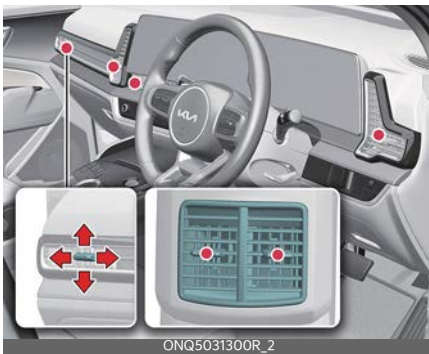

Operation

1. Adjust the direction of air delivered from the vents.
2. To close the vent, push the air vent lever in the opposite direction of the passenger.
3. To open the vent, push the air vent lever in the same direction of the passenger.

Air conditioning (A/C) (if equipped)



Operation

- Press the A/C button.

Manual climate control system (if equipped)

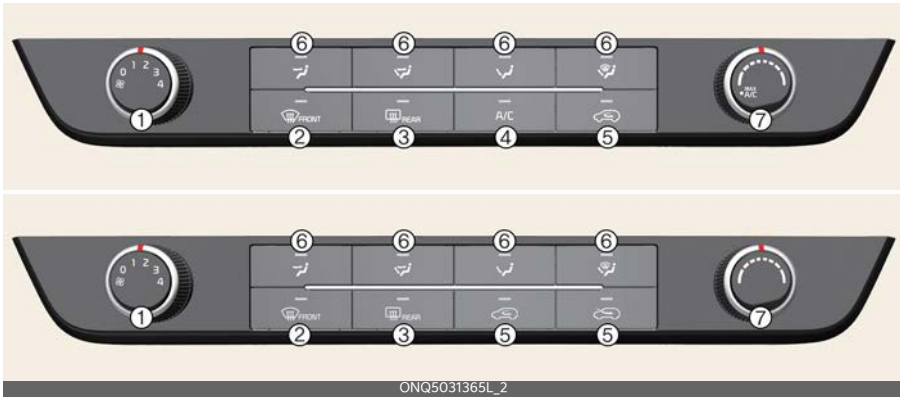

- 1 Fan speed control knob
- 2 Front windscreen defroster button
- 3 Rear window defroster button
- 4 Air conditioning (A/C) button (if equipped)
- 5 Air intake control button
- 6 Mode selection button
- 7 Temperature control knob

Controlling temperature/fan speed control

Temperature



Fan speed



Operation

1. Turn the knob to the left or right to adjust the fan speed or temperature.
2. Turn the fan speed control knob to the '0' position to turn the blowers off.

Max A/C mode (if equipped)



Operation

- Turn the knob to the left to turn Max A/C mode on.
 - A/C will always turn on.
 - Air intake control will be set to recirculated air mode.
 - The air flow will be set to face-level mode.

Automatic climate control system (if equipped)

Type A (button)



Type B (control panel)



- 1 Driver's temperature control knob
- 2 Passenger's temperature control knob
- 3 AUTO (automatic control) button
- 4 OFF button
- 5 Fan speed control button
- 6 Mode selection button
- 7 Front windscreen defroster button
- 8 Rear window defroster button
- 9 SYNC button
- 10 Air intake control button
- 11 Air conditioning (A/C) button
- 12 Front glass heater (if equipped)
- 13 Infotainment/climate control mode switching button

Using the infotainment/climate switchable controller control panel (For Type B)

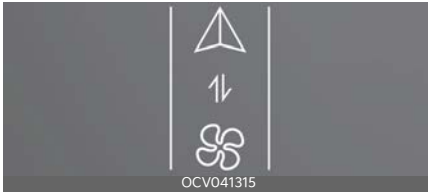

Press the button on the switchable controller to switch between infotainment system or climate control panel.
Press and hold the button to select the default mode for the control panel.

Switching between panels

Infotainment control panel



Climate control panel



Press the button on the switchable controller to select the desired control panel. The selected control panel icon will be illuminated and the control panel will be changed.

- The knob display will be illuminated according to the selected control panel mode.

- When the vehicle is in the ACC position, only the infotainment system will be activated.

Setting the default mode



Press and hold the button to select the default mode for the control panel.

- After the setting, the control panel will return to the default mode after a certain period of time even if the control panel is switched to the different mode.
- If the mode is set to 'OFF', the control panel will display the mode used recently.

Controlling heating and air conditioning automatically

Type A (button)



Type B (control panel)



Operation

1. Set the desired temperature.
2. Press the AUTO button to control:
 - Mode
 - Fan speed
 - Air intake
 - Air conditioning

For Type A (button)

| Level | Indicator | LCD Display | Air flow |
|--------|-----------|-------------|----------|
| High | | | 1-8 |
| Medium | | | 1-6 |
| Low | | | 1-4 |

For Type B (control panel)

| Level | Indicator | LCD Display | Air flow |
|--------|-----------|-------------|----------|
| High | | | 1-8 |
| Medium | | | 1-6 |
| Low | | | 1-4 |

* NOTICE

- To turn the automatic operation off, select any button or switch of the following:
 - Temperature controlling knob
 - Mode selection button
 - Air conditioning button
 - Front windscreen defroster button (Press the button one more time to deselect the front windscreen

defroster function. The AUTO sign will illuminate on the information display once again.)

- Fan speed control button
- The selected function will be controlled manually whilst other functions operate automatically.
- For your convenience and to improve the effectiveness of the climate control, use the AUTO button and set the temperature to 22 °C (72 °F).

Controlling temperature

Type A (button)



Type B (control panel)



Operation

- Turn the knob left or right to the desired temperature.

* NOTICE

Never place anything over the sensor located on the instrument panel to ensure better control of the heating and cooling system.

Adjusting driver and passenger side temperature equally



Operation

1. Press the 'SYNC' button.
2. Move the driver's side temperature control switch.

Changing temperature scale (For Type A (button))

Operation

- Press both AUTO and OFF button to switch the temperature unit from °C to °F.
 - For more than approximately 3 seconds.

Controlling fan speed

Type A (button)



Type B (control panel)



Operation

- Press left or right button to adjust the speed.

Turning the fan OFF

Type A (button)



Type B (control panel)



Operation

- Press 'OFF' button or press the left knob to turn the blowers off.

Climate control features

Automatic air ventilation (if equipped)

When operating heater and air conditioner for the vehicle ventilation, if you maintain the Recirculation mode for 30 minutes or over at low temperature, it automatically changes to Fresh mode.

Automatic air ventilation control procedure

Auto dehumidify is activated when you select 'Settings → Vehicle → Climate → Automatic Ventilation → Auto dehumidify' from the Settings menu in the Infotainment System screen.

For more details, please scan the QR code in a separately supplied Car Infotainment System Quick Reference Guide.

Sunroof inside air recirculation (if equipped)

The outside (fresh) air position is automatically selected, when the sunroof is opened whilst operating the heating/air conditioning system.

When you select the recirculated air position, the system maintains the recirculated air position for 3 minutes and then automatically converts to the outside (fresh) air position.

When the sunroof is closed, the air intake position will return to the original position that was selected.

Activate upon washer fluid use (if equipped)

To prevent the odor from entering to inside the vehicle, the ventilation system changes to Recirculated Air Mode for a whilst when the windscreen washer fluid sprayed.

Go to 'Settings → Climate → Recirculate Air → Activate upon Washer Fluid Use' on the infotainment system.

For more details, please scan the QR code in a separately supplied Car Infotainment System Quick Reference Guide.

Auto. controls that use climate control settings (for driver's seat) (if equipped)

The temperature of the driver's seat warmer, air ventilated seat and heated steering wheel is automatically controlled depending on the inside and outside temperature of the vehicle when the vehicle is running.

The heated steering wheel and seat warmer/ventilation defaults to the OFF position whenever the vehicle is restarted. However, if the "Auto. controls that use climate control settings" is ON, the heated steering wheel and seat warmer/ventilation will turn on and off depending on the inside and outside temperature.

Operation

- Select **Settings → Vehicle → Seat → Heating/Ventilation → Auto. Controls That Use Climate Control Settings → Steering wheel warmer/Seat warmer/ventilation** on the infotainment screen.

* NOTICE

For detailed information, refer to Navigation Quick Reference Guide.

* INFORMATION

The infotainment system may change after software updates. For more information, refer to the manual provided in the infotainment system and the quick reference guide.

Windscreen defrosting and defogging

Defrosting/defogging windscreen

Manual type

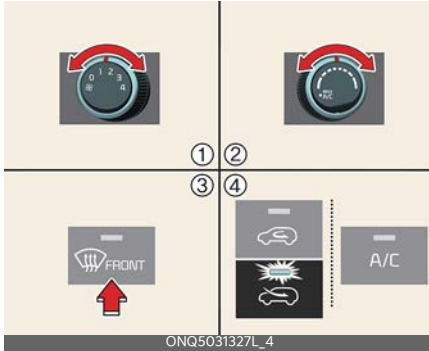

Automatic type A (button)

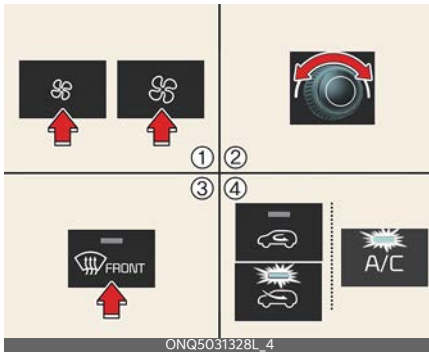

Automatic type B (control panel)

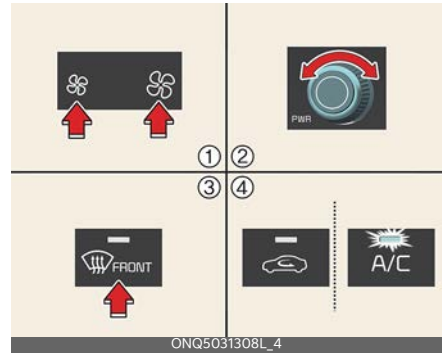

Operation

1. Set the fan speed to the desired position.
2. Select desired temperature.
3. Select (🌀) or (🌀).
4. The outside (fresh) air and air conditioning will be selected automatically.

⚠️ WARNING

Windscreen heating

Do not use the (🌀) or (🌀) position during cooling operation in extremely humid weather. The difference between the temperature of the outside air and the windscreen could cause the outer surface of the windscreen to fog up, causing loss of visibility. In this case, set the mode selection to the (🌀) position and fan speed control to the lower speed.

Auto defogging for automatic climate control (if equipped)



Operation

- The Auto Defogging System will be enabled as follows:
 1. The A/C button will turn ON.
 2. The air intake control will change to fresh mode under low outside temperature.
 3. The mode will be changed to defrost to direct the airflow to the windscreen.
 4. The fan speed will be increased.

Operating condition(s)

- When the heater or air conditioning is on.
- A high amount of humidity is detected in the vehicle.

Cancelling or resetting auto defogging

Operation

- Press  for 3 seconds.
 - The button indicator will blink 3 times if cancelled.
 - The button indicator will blink 6 times if reset.

* NOTICE

- When the air conditioning is turned on by Auto defogging system, if you try

to turn off the air conditioning, the air conditioning will not be turned off.

- To maintain the effectiveness and efficiency of the Auto Defogging System, do not select Recirculation mode whilst the system is operating.
- When the Auto Defogging System is operating, the fan speed adjustment knob, the temperature adjustment knob, and the air intake control button are all disabled.
- Do not remove the sensor cover located on the upper end of the driver side windscreen glass.
Damage to system parts could occur and may not be covered by your vehicle warranty.

Rear window/outside mirror defroster (if equipped)



Operation

1. Press the rear window defroster button. The indicator illuminates when the defroster is ON.
2. It turns OFF after approximately 20 minutes or when the vehicle is in OFF position.

CAUTION

Conductors

To prevent damage to the conductors bonded to the inside surface of the rear window, never use sharp instruments or

window cleaners containing abrasives to clean the window.

Resetting defogging logic

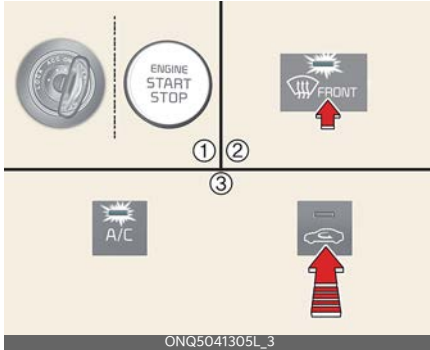

Operation

1. Turn the vehicle to the ON position.
2. Select (FRONT).
3. Within 10 seconds, press air intake button 5 times whilst pressing the air conditioner button (A/C).

The indicator light will blink 3 times. Defog logic status is reset if the battery has been discharged or disconnected.

Front glass heater (if equipped)

The front glass heater heats the window to remove frost, fog and thin ice from the interior and exterior of the front window, whilst the engine is running.



If there is heavy accumulation of snow on the front window, brush it off before operating the front glass heater.



To activate the front glass heater:

- Press the front glass heater button. The indicator on the front glass heater button illuminates when the front glass heater is ON.

The front glass heater automatically turns off after approximately 15 minutes or when the ignition switch or ENGINE START/STOP button is turned off. However, if you press the button again after the heater is turned off automatically after 15 minutes, the heater will stay on only for approximately 5 minutes. To turn off the front glass heater whilst it is operating, press the front glass heater button again.

Storage compartment

Centre console storage/glove box

Opening centre console storage/glove box



Operation

1. Pull the lever upward to open the centre console storage.
2. Pull the handle to open the glove box.

⚠ WARNING

- **Flammable materials**

Do not store glasses, gas lighter, portable battery, canned beverage, spray can, propane cylinder, cosmetic tube or other flammable/explosive materials in the vehicle. These items may catch fire and/or explode if the vehicle is exposed to hot temperatures for extended periods.

- **Glove box**

To reduce the risk of injury in an accident or sudden stop, always keep the glove box door closed whilst driving.

⚠ CAUTION

- To avoid possible theft, do not leave valuables in the storage compartment.

- Always keep the storage compartment covers closed whilst driving. Do not attempt to place so many items in the storage compartment that the storage compartment cover cannot close securely.
- Do not keep food in the glove box for a long time.

Luggage net holder

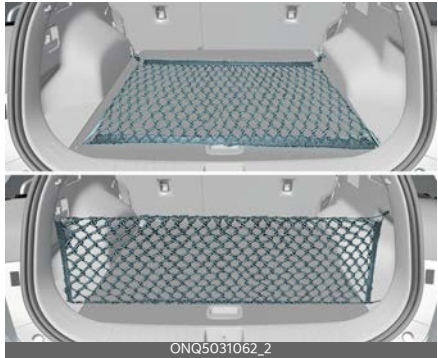

There are 4 holders located in the cargo area. The luggage net (if equipped) can be attached in 2 ways.

⚠ WARNING

Avoid eye injury. DO NOT overstretch the luggage net, ALWAYS keep your face and body out of the luggage net's recoil path. DO NOT use when the strap has visible signs of wear or damage.

⚠ CAUTION

To prevent damage to the goods or the vehicle, care should be taken when carrying fragile or bulky objects in the luggage compartment.

Cargo security screen (if equipped)

Installing cargo security screen

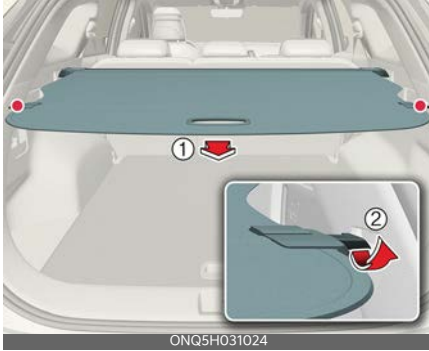

ONQ5H031024

- 1 Cargo security screen handle
- 2 Cargo security screen guide

Operation

1. Pull the cargo security screen towards the rear of the vehicle by the handle (1).
2. Insert the guide pin into the guide (2).

▲ WARNING

- Do not place objects on the cargo security screen. Such objects may move around inside the vehicle and possibly injure vehicle occupants during an accident or when braking.
- Never allow anyone to ride in the luggage compartment. It is designed for luggage only.
- Maintain the balance of the vehicle and locate the weight as forward as possible.

*** NOTICE**

- Since the cargo security screen may be damaged or malformed, do not put luggage on it when it is used.

- Pull out the cargo security screen using the handle in the centre to prevent the guide pin from falling out of the guide.
- The cargo security screen may not automatically slide back in if the cargo security screen is not fully pulled out. Fully pull it out and then let go.

Removing cargo security screen



ONQ5031364L



ONQ5051105L

Operation

1. Push the guide pin in the direction.
2. Pull the cargo security screen out.
3. Open the luggage board(1) and side tray cover (2) and keep the cargo security screen in the tray (3) (if petrol engine and mini temporary spare tyre equipped in luggage).

Interior features

Ambient lights (if equipped)



The ambient lights are applied to the front instrument panel and the centre console.

Cup holders



Press the button to use the cup holder. Cups or small beverage cans can be placed in the cup holders. Slide the cup holder to use it as a storage area.

⚠ WARNING

• Hot liquids

- Do not place uncovered cups with hot liquid in the cup holder whilst the vehicle is in motion. If the hot liquid spills, you burn yourself. Such a burn to the driver could lead to loss of control of the vehicle.
- To reduce the risk of personal injury in the event of sudden stop or collision, do not place uncovered or unsecured bottles, glasses, cans,

etc., in the cup holder whilst the vehicle is in motion.

- Keep cans or bottles out of direct sun light and do not put them in a vehicle that is heated up. It may explode.

*** NOTICE**

- Keep your drinks sealed whilst driving to prevent spilling your drink. If liquid spills, it may get into the vehicle's electrical/electronic system and damage electrical/ electronic parts.
- When cleaning spilled liquids, do not dry the cup holder at high temperature. This may damage the cup holder.

Seat warmer/ventilation (if equipped)

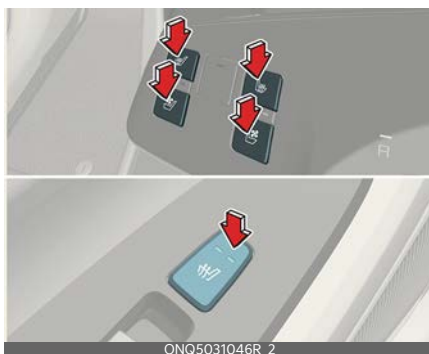

The seat warmer/ventilation is provided to warm/cool the front and the rear seats.

* The seat ventilation is provided only on the front seats.

Operation

1. Push the buttons to control the function.

2. It defaults to the OFF position the vehicle is in ON position.
3. The seat warmer/ventilation automatically controls the seat temperature depending on the ambient temperature when the vehicle is running. For more details, refer to "Auto. controls that use climate control settings (for driver's seat) (if equipped)" on page 4-84.
4. The temperature setting of the seat will change as follows:

| Temperature | Duration |
|-------------|------------|
| OFF | - |
| High | 30 minutes |
| Medium | 60 minutes |
| Low | - |

* Rear seats does not have the medium temperature.

⚠ WARNING

Seat warmer burns

Passengers should use extreme caution when using seat warmers due to the possibility of excess heating or burns. The seat warmer may cause burns even at low temperatures, especially if used for long periods of time. In particular, the driver must exercise extreme care for the following types of passengers:

- Infants, children, elderly or handi-capped persons, or hospital outpatients
- Persons with sensitive skin or those that burn easily
- Fatigued individuals
- Intoxicated individuals
- Individuals taking medication that can cause drowsiness or sleepiness (sleeping pills, cold tablets, etc.)

⚠ CAUTION

- When cleaning the seats, do not use an organic solvent such as paint thinner, benzene, alcohol and petrol. Doing so may damage the surface of the heater or seats.
- To prevent overheating the seat warmer, do not place anything on the seats that insulates against heat, such as blankets, cushions or seat covers whilst the seat warmer is in operation.
- Do not place heavy or sharp objects on seats equipped with seat warmers. Damage to the seat warming components could occur.
- Do not change the seat cover. It may damage the seat warmer or air ventilation system.
- **Seat damage**
 - When cleaning the seats, do not use an organic solvent such as paint thinner, benzene, alcohol and petrol. Doing so may damage the air ventilation seat.

*** NOTICE**

With the seat warmer button in the ON position, the heating system in the seat turns off or on automatically depending on the seat temperature.

Sun visor



Operation

1. Pull down, unsnap it from the bracket (1).
2. Swing it to the side (2).
 - Slide the sun visor if necessary (3).
 - Pull down and slide the mirror cover (4) to use the vanity mirror.
 - The ticket holder (5) is provided for holding a tollgate ticket.

⚠ WARNING

For your safety, do not block your view when using the sun visor.

*** NOTICE**

Do not put several tickets in the ticket holder at one time. This could cause damage to the ticket holder.

USB charger/port (if equipped)



The USB car charger allows drivers and passengers to charge their digital devices like smart phone, and PC tablets.

*** INFORMATION**

- Power Delivery 3.0 is available on the smart phone or the tablet PC equipped with fast charging capabilities. It is applicable to digital devices

with USB C-type. Charging speed is determined according to the charging specification of the connected digital device.

- Rated output
 - Digital device with fast charging : 9.0V / Max 3.0A
 - Digital devices with normal charging : 5.0V / Max 3.0A

⚠ CAUTION

- Use the USB car charger with the ignition on. Otherwise, Vehicle battery can be discharged.
- Use the official USB cable of the manufacturer of the digital device to be charged.
- Make sure that any foreign object, drinks, and water do not come into contact with the USB car charger. Water or foreign object can damage the USB charger.
- Do not use the device those current consumption exceeds 2.1 A.
- Do not connect an electrical device that generates excessive electromagnetic noise to the USB car port. If you do so, noise can be caused or vehicle electronic devices can be interrupted whilst audio or AV is on.
- If the charger is connected incorrectly, it can cause serious damage on the devices. Please note that damages due to incorrect usage are not covered by warranty service.

Power outlet (if equipped)

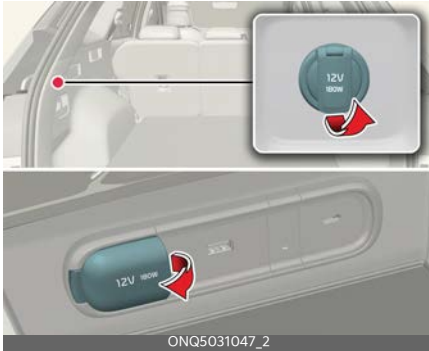

The power outlet allows drivers and passengers to charge their digital devices like smart phone, and PC tablets.

Operating condition(s)

- The devices should draw less than 15 A when the vehicle is in ON position.

⚠ WARNING

- Use the power outlet only when the vehicle is on and remove the accessory plug after use. Using the accessory plug for prolonged periods of time with the vehicle off could cause the battery to discharge.
- Only use 12 V electric accessories which are less than 15 A in electric capacity.
- Adjust the air-conditioner or heater to the lowest operating level when using the power outlet.
- Close the cover when not in use.
- Some electronic devices can cause electronic interference when plugged into a vehicle's power outlet. These devices may cause excessive audio static and malfunctions in other electronic systems or devices used in your vehicle.

- Push the plug in as far as it will go. If good contact is not made, the plug may overheat and the fuse may open.
- Plug in battery equipped electronic devices with reverse current protection. The current from the battery may flow into the vehicle's electrical/electronic system and cause system malfunction.
- **Electric shock**
Do not put a finger or a foreign object (pen, etc.) into a power outlet and do not touch with a wet hand. You may get an electric shock.

⚠ CAUTION

Do not connect another vehicle's Tyre Mobility Kit (TMK) to the power outlet or battery terminal. The unmatched power requirement between the vehicle power outlet and the tyre mobility kit can cause fire or circuit damage within the vehicle and the Tyre Mobility Kit.

Wireless smart phone charging system (if equipped)

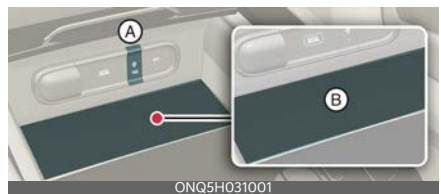

- A: Indicator
- B: Charging pad

Operation

1. Place the smart phone on the centre of the wireless charging pad.
2. The indicator light will change to orange once the wireless charging

begins. The light will change to green when the charging is complete.

3. You can choose to turn the wireless charging function ON or OFF from the Settings menu.

Operating condition(s)

- The wireless charging system is designed for one smart phone equipped with Qi only.

* INFORMATION

- If the wireless charging does not work, gently move your smart phone around the pad until the charging indicator light turns orange. Depending on the smart phone, the charging indicator light may not turn green even after the charging is complete.
- If the wireless charging is not functioning properly, the orange light will blink and flash for ten seconds then turn off. In such cases, remove the smart phone from the pad and replace it on the pad again, or double check the charging status.
- The system warns you with a message on the instrument cluster if the smart phone is still on the wireless charging unit after the vehicle is turned OFF and the front door is opened.

⚠ WARNING

If any metallic object such as coins is located between the wireless charging system and the smart phone, the charging may be disrupted. Also, the metallic object may heat up.

⚠ CAUTION

- When the interior temperature of the wireless charging system rises above a set temperature, the wireless charging will cease to function. After the interior temperature drops below the threshold, the wireless charging function will resume.
- If there is any metallic object between the smart phone and the wireless charging pad, immediately remove the smart phone. Remove the metallic object after it has completely cooled down.
- The wireless charging may not function properly when there is a heavy accessory cover on the smart phone.
- The wireless charging will stop when using the wireless smart key search function to prevent radio wave disruption.
- The wireless charging will stop when the smart key is moved out of the vehicle with the ignition in ON.
- The wireless charging will stop when any of the doors is opened (applicable for vehicles equipped with smart keys).
- The wireless charging will stop when the vehicle is turned OFF.
- The wireless charging will stop when the smart phone is not in complete contact with the wireless charging pad.
- Items equipped with magnetic components such as credit card, telephone card, bankbook, any transportation ticket and such may become damaged during wireless charging.
- Place the smart phone on the centre of the charge pad for best results. The

smart phone may not charge when placed near the rim of the charging pad. When the smart phone does get charged, it may heat up excessively.

- For smart phones without built-in wireless charging system, an appropriate accessory has to be equipped.
- Smart phones of some manufacturers may display messages on weak current. This is due to the particular characteristic of the smart phone and does not imply a malfunction on wireless charging function.
- The indicator light of some manufacturers' smart phones may still be yellow after the smart phone is fully charged. This is due to the particular characteristic of the smart phone and not a malfunction of the wireless charging.
- When any smart phone without a wireless charging function or a metallic object is placed on the charging pad, a small noise may sound. This small sound is due to the vehicle discerning compatibility of the object placed on the charging pad. It does not affect your vehicle or the smart phone in any way.
- The wireless cellular phone charging system may not support certain cellular phones, which are not verified for the Qi specification ().
- For certain cellular phones with their own protection, the wireless charging speed may decrease and the wireless charging may stop.

wireless charging unit. This is due to the particular characteristic of the smart phone and not a malfunction of the wireless charging.

Coat hook

A coat hook is located on the rear grab handle and on the headrest of the front seats (if equipped).



WARNING

Do not hang other objects such as hangers or hard objects except clothes. Also, do not put heavy, sharp or breakable objects in the clothing's pockets. In an accident or when the curtain air bag is inflated, it may cause vehicle damage or body injury.

CAUTION

Hanging clothing

Do not hang heavy clothes, since they may damage the hook.

NOTICE

For some manufacturers' smart phones, the system may not warn you even though the smart phone is left on the

Side curtain (if equipped)



Operation

1. Lift the curtain by the hook (1).
2. Hang the curtain on both sides of the hook.

* NOTICE

- Always hang both sides of the curtain on the hook. This could cause damage to the side curtain if only one side of the curtain is hooked.
- Do not let any foreign material get in between the vehicle and side curtain. The side curtain may not be lifted up.

Floor mat anchors



Make sure the floor mat attaches to the anchors to keep the floor mat from sliding forward.

⚠ WARNING

- **After market floor mat**
 - Do not install after market floor mats that are not capable of being securely attached to the vehicle's floor mat anchors. Unsecured floor mats can interfere with pedal operation.

- Use floor mats not too thick and designed to be properly secured on the floor to avoid the interference with pedals. Make sure that installing the floor mats without removing plastic films on carpets may damage or break floor mat fix rings, resulting in the mats to be unsecured. Especially for a driver's seat, the unsecured mats may cause unintended acceleration/ brake. Ensure to remove all the plastic films on the carpets before installing the mats.

Exterior features

Roof rack (if equipped)

Type A



ONQ5H031019

Type B



ONQ5H031036

You can load cargo on top of your vehicle.

⚠ WARNING

- The following specification is the maximum weight that can be loaded onto the roof rack. Distribute the load as evenly as possible across the cross-bars (if equipped) and roof rack and secure the load firmly.

| | |
|-----------|---|
| ROOF LOAD | 100 kg (220 lbs.) EVENLY DISTRIBUTED |
|-----------|---|

Loading cargo or luggage in excess of the specified weight limit on the roof rack may damage your vehicle.

- The vehicle centre of gravity will be higher when items are loaded onto the roof rack. Avoid sudden starts, braking, sharp turns, abrupt manoeuvres or high speeds that may result in loss of vehicle control or rollover resulting in an accident.

- Always drive slowly and turn corners carefully when carrying items on the roof rack. Severe wind updrafts, caused by passing vehicles or natural causes, can cause sudden upward pressure on items loaded on the roof rack. This is especially true when carrying large, flat items such as wood panels or mattresses. This could cause the items to fall off the roof rack and cause damage to your vehicle or others around you.
- To prevent damage or loss of cargo whilst driving, check frequently before or whilst driving to make sure the items on the roof rack are securely fastened.

⚠ CAUTION

- When carrying cargo on the roof rack, take the necessary precautions to make sure the cargo does not damage the roof of the vehicle.
- When carrying large objects on the roof rack, make sure they do not exceed the overall roof length or width.
- When you are carrying cargo on the roof rack, do not operate the sunroof (if equipped)

*** NOTICE**

- The crossbars (if equipped) should be placed in the proper load carrying positions prior to placing items onto the roof rack.
- If the vehicle is equipped with a sunroof, be sure not to position cargo onto the roof rack in such a way that it could interfere with sunroof operation.

- When the roof rack is not being used to carry cargo, the crossbars may need to be repositioned if wind noise is detected.

Infotainment system

Using the infotainment/climate switchable controller (if equipped)



Press the button on the switchable controller to switch between infotainment system or climate control panel.

Press and hold the button to select the default mode for the control panel.

Switching between panels

Infotainment control panel



Climate control panel



Press the button on the switchable controller to select the desired control panel. The selected control panel icon will be illuminated and the control panel will be changed.

- The knob display will be illuminated according to the selected control panel mode.

- When the vehicle is in the ACC position, only the infotainment system will be activated.

Setting the default mode



Press and hold the button to select the default mode for the control panel.

- After the setting, the control panel will return to the default mode after a certain period of time even if the control panel is switched to the different mode.
- If the mode is set to 'OFF', the control panel will display the mode used recently.

| | |
|---|------------|
| Audio system | 5-2 |
| • Antenna | 5-2 |
| • USB port | 5-2 |
| • How vehicle radio works..... | 5-3 |
| Audio (Without Touch Screen) | 5-6 |
| • System overview | 5-6 |
| • Radio..... | 5-11 |
| • Media player..... | 5-15 |
| • Bluetooth..... | 5-18 |
| • THE EMERGENCY CALL SERVICE | 5-26 |
| • System status icons | 5-26 |
| • System specifications..... | 5-27 |
| • Trademarks..... | 5-28 |
| • Declaration of Conformity..... | 5-29 |

Infotainment system

Audio system

Antenna

Type A/B

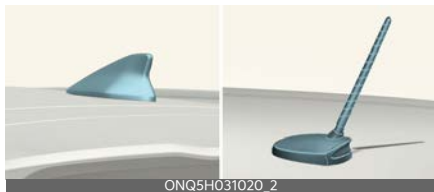

- Shark fin antenna (Type A)
 - The shark fin antenna transmits and receives wireless signals such as AM/FM, DAB, GNSS, LTE etc.
- Pole antenna (Type B)
 - The pole type antenna receives both AM and FM signals.

* NOTICE

- The signals which antenna can transmit and receive vary by the vehicle option.
- If you install an aftermarket HID head lamp, your vehicle's audio and electronic device may malfunction.
- Avoid adding metallic coatings such as Ni, Cd, etc. These can degrade the receiving AM and FM broadcast signals.

USB port



You can use an USB port to plug the USB in.

⚠ WARNING

Cell phone use

Do not use a cellular phone whilst driving. Stop at a safe location to use a cellular phone.

⚠ CAUTION

- Depending on the size, length, or shape of the USB stick, if you forcibly close the tray cover, the USB device may be damaged or deformed or the cover may not reopen as the device is stuck. When the stick is stuck, forcibly opening the cover can also cause damage to the device. If the USB stick does not fit into the space, do not close the cover and try another USB stick with different specifications.
- When using a communication system such as a cellular phone or a radio set inside the vehicle, a separate external antenna must be fitted. When a cellular phone or a radio set is used with only the internal antenna, it may interfere with the vehicle's electrical system and adversely affect the safe operation of the vehicle.

How vehicle radio works

FM reception

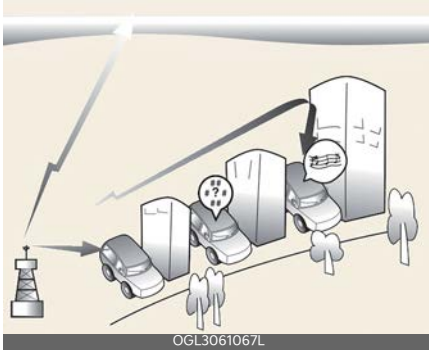

AM and FM radio signals are broadcast from transmitter towers located around your city. They are intercepted by the radio antenna on your vehicle. This signal is then processed by the radio and sent to your vehicle speakers.

However, in some cases the signal coming to your vehicle may not be strong and clear.

This can be due to factors, such as the distance from the radio station, closeness of other strong radio stations or the presence of buildings, bridges or other large obstructions in the area.

AM reception

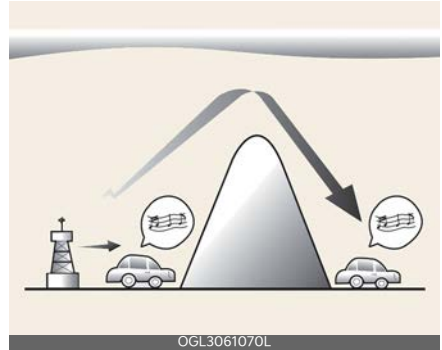

AM broadcasts can be received at greater distances than FM broadcasts. This is because AM radio waves are transmitted at low frequencies. These long distance, low frequency radio waves can follow the curvature of the earth rather than travelling straight. In addition, they curve around obstructions resulting in better signal coverage.

FM radio station

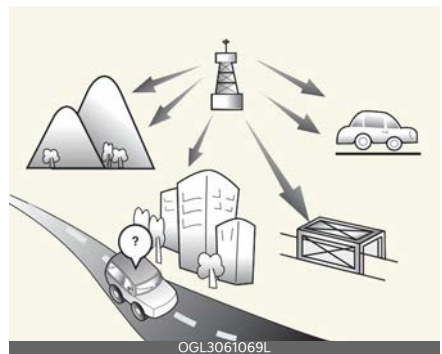

FM broadcasts are transmitted at high frequencies and do not bend to follow the earth's surface. Because of this, FM broadcasts generally begin to fade within short distances from the station. Also, FM signals are easily affected by buildings, mountains, and obstructions.

This can lead to undesirable or unpleasant listening conditions which might lead you to believe a problem exists with your radio.

The following conditions are normal and do not indicate radio trouble:

- Fading - As your vehicle moves away from the radio station, the signal will weaken and sound will begin to fade. When this occurs, we suggest that you select another station with a stronger signal.

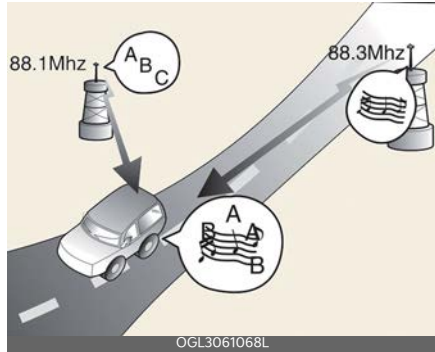

- Multi-Path Cancellation - Radio signals being received from several directions can cause distortion or fluttering. This can be caused by a direct and reflected signal from the same station, or by signals from two stations with close frequencies. If this occurs, select another station until the condition has passed.

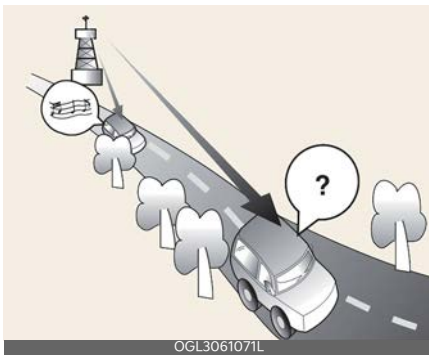

- Flutter/Static - Weak FM signals or large obstructions between the transmitter and your radio can disturb the signal causing static or fluttering noises to occur. Reducing the treble level may lessen this effect until the disturbance clears.
- Station Swapping - As an FM signal weakens, another more powerful signal near the same frequency may begin to play. This is because your radio is designed to lock onto the clearest signal. If this occurs, select another station with a stronger signal.

Using a cellular phone or a two-way radio

When a cellular phone is used inside the vehicle, noise may be produced from the audio system. This does not mean that something is wrong with the audio equipment. In such a case, try to operate mobile devices as far from the audio equipment as possible.

⚠ CAUTION

When using a communication system such as a cellular phone or a radio set inside the vehicle, a separate external antenna must be fitted. When a cellular phone or a radio set is used with only the internal antenna, it may interfere with the vehicle's electrical system and adversely affect the safe operation of the vehicle.

 **WARNING**

Cell phone use

Do not use a cellular phone whilst driving. Stop at a safe location to use a cellular phone.

Audio (Without Touch Screen) (if equipped)

System overview

System layout - control panel

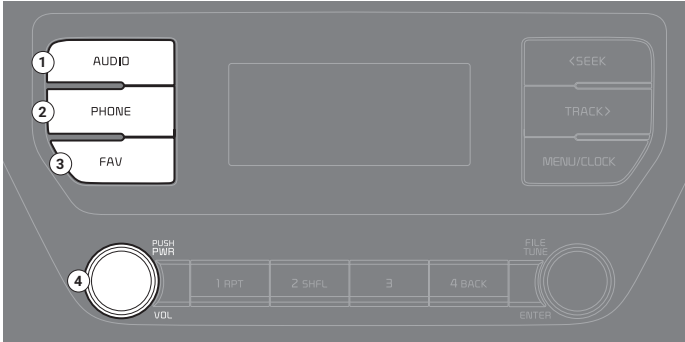

(With Bluetooth® Wireless Technology)

* The system’s actual appearance and layout may differ depending on the vehicle model and specification.

1. AUDIO button

- Press to display the radio/media mode selection window.
- When the mode selection window displays, turn the [TUNE] knob to select the desired mode and then press the knob.
- When the Mode popup is not selected in [MENU/CLOCK] ► **Mode popup**, press the [AUDIO] button on the control panel to change the mode.

Each time you press the [AUDIO] button on the control panel, the mode switches to radio ► media in order.

2. PHONE button

- Press to start connecting a mobile phone via Bluetooth.
- After a Bluetooth phone connection is made, press to access the Bluetooth phone menu.

3. FAV button

- Whilst listening to the radio, press to move to next page of the preset list.

4. POWER button/VOL knob

- Press to turn the system on or off.
- Turn to the left or right to adjust the system sound volume.

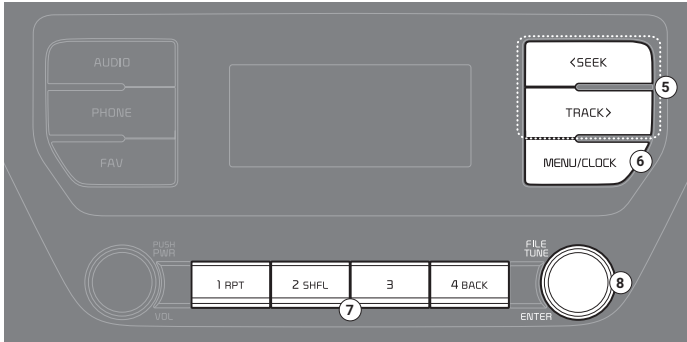

(With Bluetooth® Wireless Technology)

* The system’s actual appearance and layout may differ depending on the vehicle model and specification.

5. SEEK/TRACK button

- Change the station/track/file.
- Whilst listening to the radio, press and hold to search for a station.
- Whilst playing media, press and hold to rewind or fast forward (except for Bluetooth audio mode).

6. MENU button/CLOCK button

- Press to access the menu screen for the current mode..
- Press and hold to access the time setup screen.

7. TUNE knob/FILE knob/ENTER button

- Whilst listening to the radio, turn to adjust the frequency.
- Whilst playing media, turn to search for a track/file (except for Bluetooth audio mode).
- Whilst searching by turning the knob, press to select the current track/file (except for the Bluetooth audio mode).

8. Number buttons (1 RPT~ 4 BACK)

- Whilst listening to the radio, press to listen to a saved radio station.
- Whilst listening to the radio, press and hold to save the current radio station to the preset.
- In the USB/Bluetooth audio modes, press the [1 RPT] button to change the repeat play mode. Press the [2 SHFL] button to change the shuffle play mode.
- Press the [4 BACK] button to return to the previous screen (except for the radio preset list).

System layout - steering wheel remote control

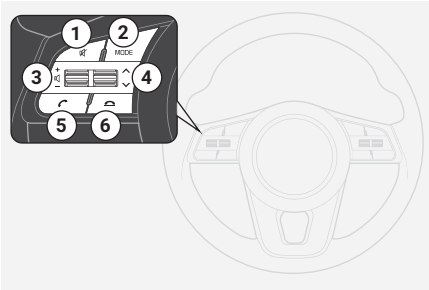

(Bluetooth® equipped model)

* The system’s actual appearance and layout may differ depending on the vehicle model and specification.

1. MUTE button

- Press to mute or unmute the system.
- During a call, press to mute or unmute the microphone.
- Whilst playing media, press to pause or resume playback. (if equipped)

2. MODE button

- Press to switch between radio and media modes.
- Press and hold to turn the system on or off.

3. Volume lever

- Push up or down to adjust the volume.

4. Up/Down lever

- Change the station/track/file.
- Whilst listening to the radio, push to listen to the previous/next saved radio station.
- Whilst listening to the radio, push and hold to search for a station.

- Whilst playing media, push and hold to rewind or fast forward (except for Bluetooth audio mode).

5. Call/Answer button

- Press to start connecting a mobile phone via Bluetooth.
- After a Bluetooth phone connection is made, press to access your call history. Press and hold to dial the most recent phone number. When a call comes in, press to answer the call.
- During a call, press to switch between the active call and the held call. Press and hold to switch the call between the system and the mobile phone.

6. Call end button

- When a call comes in, reject the call.
- During a call, end the call.

⚠ WARNING

About driving

- Do not operate the system Whilst driving. Driving Whilst distracted may result in a loss of vehicle control, potentially leading to an accident, severe personal injury, or death. The driver’s primary responsibility is the safe and legal operation of a vehicle, and any handheld devices, equipment, or vehicle systems which divert the driver’s attention from this responsibility should never be used during operation of the vehicle.
- Avoid watching the screen Whilst driving. Driving Whilst distracted may lead to a traffic accident. Stop your vehicle in a safe location before using functions that require multiple operations.
- Stop your vehicle first before using your mobile phone. Using a mobile phone Whilst driving may lead to a

traffic accident. If necessary, use the Bluetooth Handsfree feature to make calls and keep the call as short as possible.

- Keep the volume low enough to hear external sounds. Driving without the ability to hear external sounds may lead to a traffic accident. Listening to a loud volume for a long time may cause hearing damage.

⚠ WARNING

About handling the system

- Do not disassemble or modify the system. Doing so may result in an accident, fire, or electric shock.
- Do not allow liquids or foreign substances to enter the system. Liquids or foreign substances may cause noxious fumes, a fire, or a system malfunction.
- Stop using the system if it malfunctions, such as no audio output or display. If you continue using the system when it is malfunctioning, it may lead to a fire, electric shock, or system failure.
- Do not touch the antenna during thunder or lightning because such an act may cause electric shock.

⚠ CAUTION

About operating the system

- Use the system with the engine running. Using the system for a long time when the engine is stopped may discharge the battery.
- Do not install unapproved products. Using unapproved products may cause an error. Whilst using the system. System errors caused by install-

ing unapproved products are not covered under the warranty.

⚠ CAUTION

About handling the system

- Do not apply excessive force to the system. Excessive pressure on the screen may damage the LCD panel or the touch panel.
- When cleaning the screen or button panel, make sure to stop the engine and use a soft, dry cloth. Wiping the screen or buttons with a rough cloth or using solvents (alcohol, benzene, paint thinner, etc.) may scratch or chemically damage the surface.
- If you attach a liquid-type air freshener to the fan louvre, the surface of the louvre may become deformed due to the flowing air.
- If you want to change the position of the installed device, please inquire with your place of purchase or service maintenance centre. Technical expertise is required to install or disassemble the device.

*** NOTICE**

- If you experience any problems with the system, contact your place of purchase or dealer.
- Placing the infotainment system within an electromagnetic environment may result in noise interference.

Turning the system on or off

To turn on the system, start the engine.

- If you do not want to use the system. Whilst driving, you can turn off the system by pressing the **[POWER]** button on the control panel. To use the

system again, press the **[POWER]** button again.

After you have turned off the engine, the system will automatically turn off after a whilst or as soon as you open the driver's door.

- Depending on the vehicle model or specifications, the system may turn off as soon as you turn off the engine.
- When you turn back on the system, the previous mode and settings will remain intact.

⚠ WARNING

- Some functions may be disabled for safety reasons whilst the vehicle is moving. They work only when the vehicle stops. Park your vehicle in a safe location before using any of them.
- Stop using the system if it malfunctions, such as no audio output or display. If you continue using the system when it is malfunctioning, it may lead to a fire, electric shock, or system failure.

⚠ CAUTION

You can turn on the system when the key ignition switch is placed in the "ACC" or "ON" position. Using the system for an extended period without the engine running drains the battery. If you plan on using the system for a long time, start the engine.

Turning the display on or off

To prevent glare, you can turn off the screen. The screen can be turned off only whilst the system is on.

1. On the control panel, press the **[MENU/CLOCK]** button.

2. When the option selection window displays, turn the **[TUNE]** knob to select **Display off**, and then press the knob.

- To turn the screen back on, press any of the control panel buttons.

Getting to know the basic operations

You can select an item or adjust the settings by using the number buttons and the **[TUNE]** knob on the control panel.

Selecting an item

Numbered items

Press the corresponding number button.

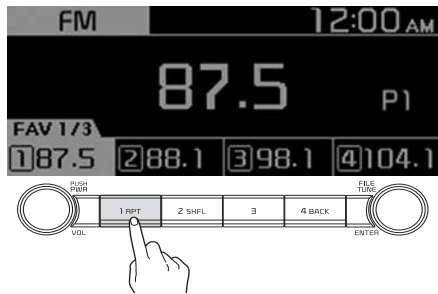

Numberless items

Turn the **[TUNE]** knob to select the desired item, and then press the knob to select the item.

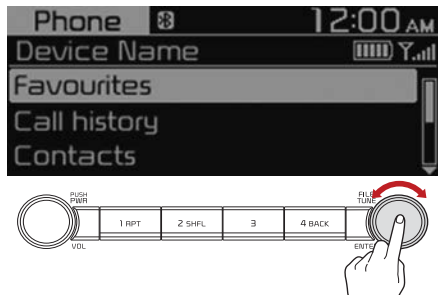

Adjusting the settings

Turn the [TUNE] knob to adjust the value, and then press the knob to save changes.

Turn the [TUNE] knob to the right to increase the value and turn the [TUNE] knob to the left to decrease the value.

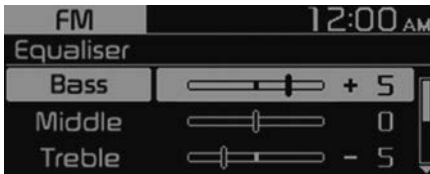

Radio

Turning on the radio

1. On the control panel, press the [AUDIO] button.
2. When the mode selection window displays, turn the [TUNE] knob to select the desired radio mode and then press the knob.

FM/AM Mode



1. Current radio mode
2. Radio station information
3. Preset list

Press the [MENU/CLOCK] button on the control panel to access the following menu options:

- **Autostore:** Save radio stations to the preset list.
- **Scan:** The system searches for radio stations with strong radio signals and

plays each radio station for about five seconds.

- **Sound settings:** You can change the settings related to sounds, such as location where sound will be concentrated and the output level for each range.
 - **Position:** Select a location where sound will be concentrated in the vehicle. Select **Fader** or **Balance**, turn the [TUNE] knob to select the desired position, and then press the knob. To set sound to be centred in the vehicle, select **Centre (Center)**.
 - **Equaliser (Tone):** Adjust the output level for each sound tone mode.
 - **Sound experience:** (if equipped) select the location where sound is focused in the vehicle between the driver's seat and all other seats.
 - **Speed dependent vol.:** Set the volume to be adjusted automatically according to your driving speed.

* NOTICE

- Depending on vehicle models or specifications, available options may vary.
- Depending on the system or amplifier specifications applied to your vehicle, available options may vary.

- **Mode popup:** Set to display mode selection window when the [AUDIO] button is pressed on the control panel.
- **Date/Time:** You can change the date and time that are shown on the system display.
 - **Set date:** Set date to display on the system display.
 - **Set time:** Set time to display on the system display.

- **Time format:** Select to display time in the 12 hour format or the 24 hour format.
- **Display (Power Off):** Set to display the clock when the system power is off.
- **Language:** You can change the display language.

FM/AM Mode (With RDS)



1. Current radio mode
2. Radio station information
3. Preset list

Press the [MENU/CLOCK] button on the control panel to access the following menu options:

- **Traffic announcement:** Activate or deactivate traffic announcements. Announcements and programmes will be received automatically if available.
- **Autostore:** Save radio stations to the preset list.
- **Scan:** The system searches for radio stations with strong radio signals and plays each option for about five seconds.
- **Sound settings:** You can change the settings related to sounds, such as location where sound will be concentrated and the output level for each range.
 - **Position:** Select a location where sound will be concentrated in the vehicle. Select **Fader** or **Balance**, turn the [TUNE] knob to select the desired position, and then press the knob. To set sound to be centred in the vehicle, select **Centre (Center)**.
- **Equaliser (Tone):** Adjust the output level for each sound tone mode.
- **Speed dependent vol.:** Set the volume to be adjusted automatically according to your driving speed.

* NOTICE

- Depending on vehicle models or specifications, available options may vary.
 - Depending on the system or amplifier specifications applied to your vehicle, available options may vary.
-
- **Mode popup:** Set to display mode selection window when the [AUDIO] button is pressed on the control panel.
 - **Date/Time:** You can change the date and time that are shown on the system display.
 - **Set date:** Set date to display on the system display.
 - **Set time:** Set time to display on the system display.
 - **Time format:** Select to display time in the 12 hour format or the 24 hour format.
 - **Display (Power Off):** Set to display the clock when the system power is off.
 - **Language:** You can change the display language.

DAB Mode (if equipped)



1. Current radio mode
2. Radio station information
3. Preset list

Press the [MENU/CLOCK] button on the control panel to access the following menu options:

- **Traffic announcement:** Activate or deactivate traffic announcements. Announcements and programmes will be received automatically if available.
- **List:** Display all available radio stations.
- **Scan:** The system searches for radio stations with strong radio signals and plays each option for about five seconds.
- **Sound settings:** You can change the settings related to sounds, such as location where sound will be concentrated and the output level for each range.
 - **Position:** Select a location where sound will be concentrated in the vehicle. Select **Fader** or **Balance**, turn the [TUNE] knob to select the desired position, and then press the knob. To set sound to be centred in the vehicle, select **Centre (Center)**.
 - **Equaliser (Tone):** Adjust the output level for each sound tone mode.
 - **Speed dependent vol.:** Set the volume to be adjusted automatically according to your driving speed.

* NOTICE

- Depending on vehicle models or specifications, available options may vary.
- Depending on the system or amplifier specifications applied to your vehicle, available options may vary.

- **Mode popup:** Set to display mode selection window when the [AUDIO] button is pressed on the control panel.
- **Date/Time:** You can change the date and time that are shown on the system display.
 - **Set date:** Set date to display on the system display.
 - **Set time:** Set time to display on the system display.
 - **Time format:** Select to display time in the 12 hour format or the 24 hour format.
 - **Display (Power Off):** Set to display the clock when the system power is off.
- **Language:** You can change the display language.

Changing the radio mode

1. On the control panel, press the [AUDIO] button.
2. When the mode selection window displays, turn the [TUNE] knob to select the desired radio mode and then press the knob.
 - Each time you press the [MODE] button on the steering wheel, the radio mode switches to FM ► AM in order (if any other media is not connected).

* NOTICE

When the Mode popup is not selected in [MENU/CLOCK] ► **Mode popup**, press

the **[AUDIO]** button on the control panel to change the radio mode.

Each time you press the **[AUDIO]** button on the control panel, the radio mode switches to FM ► AM in order (if any other media is not connected).

Scanning for available radio stations

You can listen to each radio station for a few seconds to test the reception and select the one you want.

1. From the radio screen, press the **[MENU/CLOCK]** button on the control panel.
2. When the option selection window displays, turn the **[TUNE]** knob to select **Scan**, and then press the knob.
 - The system searches for radio stations with strong radio signals and plays each radio station for about five seconds.
3. When you find the radio station you want to listen to, press the **[TUNE]** knob.
 - You can continue listening to the selected station.

Searching for radio stations

To search for the previous or next available radio station, press the **[< SEEK button / [TRACK >]** button on the control panel.

- You can also press and hold the **[< SEEK button / [TRACK >]** button to search for frequencies quickly. When you release the button, a radio station with a strong signal is selected automatically.

If you know the exact frequency of the radio station you want to listen to, turn the **[TUNE]** knob on the control panel to change the frequency.

Saving radio stations

You can save your favourite radio stations and listen to them by selecting them from the preset list.

Saving the current radio station

Whilst listening to the radio, press and hold the desired number button on the control panel.

- The radio station you are listening to will be added to the selected number.
- To save the next page of the preset list, press the **[FAV]** button.

* NOTICE

- You can save up to 12 radio stations in each mode.
- If a station is already saved to the selected preset number, the station will be replaced by the station you are listening to.

Using the auto save function

You can search for radio stations in your area where there is a strong signal. The results of your search can be saved to the preset list automatically.

- From the radio screen, press the **[MENU/CLOCK]** button on the control panel.
- When the option selection window displays, turn the **[TUNE]** knob to select **Autostore**, and then press the knob.

Listening to saved radio stations

FM/AM Mode

1. Confirm the preset number for the radio station you want to listen to.
 - To view the next page of the preset list, press the **[FAV]** button.
2. On the control panel, press the desired number button.

- Alternatively, push the Up/Down lever on the steering wheel to change the station.

Media player

Using the media player

You can play music stored in various media storage devices, such as USB storage devices, smartphones.

1. Connect a device to the USB port in your vehicle.
 - Playback may start immediately depending on the device that you connect to the system.
2. On the control panel, press the **[AUDIO]** button.
3. When the mode selection window displays, turn the **[TUNE]** knob to select the desired mode and then press the knob.

* NOTICE

- To start the media player, press the **[AUDIO]** button on the control panel.
- You can also change the mode by pressing the **[MODE]** button repeatedly on the steering wheel.
- Make sure to connect or disconnect external USB devices with the system power turned off.
- When the Mode popup is not selected in **[MENU/CLOCK] ▶ Mode popup**, press the **[AUDIO]** button on the control panel to change the media player. Each time you press the **[AUDIO]** button on the control panel, the media mode switches to Bluetooth audio ▶ USB ▶ FM ▶ AM in order.
- Depending on vehicle models and specifications, available buttons or the appearance and layout of the USB port in your vehicle may vary.

- Do not connect a smartphone or an MP3 device to the system via multiple methods such as USB, Bluetooth simultaneously. Doing so may cause a distorted noise or a system malfunction.
- When the equaliser function of the connected device and **Equaliser (Tone)** settings of the system are both activated, the effects may interfere with each other and may lead to sound degradation or distortion. Deactivate the device's equaliser function if possible.

Using the USB mode

You can play media files stored in portable devices, such as USB storage devices and MP3 players. Check compatible USB storage devices and file specifications

before using the USB mode. Connect your USB device to the USB port in the vehicle.

- Playback starts immediately.
- Press the **[AUDIO]** button on the control panel to display the mode selection window, turn the **[TUNE]** knob to select **USB** and then press the knob.



1. Current file number and total number of files
2. Playback time
3. Information about the song currently playing

Press the **[MENU/CLOCK]** button on the control panel to access the following menu options:

- **List:** Access the file list.
- **Folder list:** Access the folder list.
- **Information:** Display information about the song currently playing.
- **Sound settings:** You can change the settings related to sounds, such as location where sound will be concentrated and the output level for each range.
 - **Position:** Select a location where sound will be concentrated in the vehicle. Select **Fader** or **Balance**, turn the **[TUNE]** knob to select the desired position, and then press the knob. To set sound to be centred in the vehicle, select **Centre (Center)**.
 - **Equaliser (Tone):** Adjust the output level for each sound tone mode.
 - **Speed dependent vol.:** Set the volume to be adjusted automatically according to your driving speed.

*** NOTICE**

- Depending on vehicle models or specifications, available options may vary.
- Depending on the system or amplifier specifications applied to your vehicle, available options may vary.

-
- **Song information (Media Display):** Select information such as **Folder/File** or **Artist/Title/Album** to display when playing MP3 files.
 - **Mode popup:** Set to display mode selection window when the **[MEDIA]** button is pressed on the control panel.
 - **Date/Time:** You can change the date and time that are shown on the system display.
 - **Set date:** Set date to display on the system display.
 - **Set time:** Set time to display on the system display.

- **Time format:** Select to display time in the 12 hour format or the 24 hour format.
- **Display (Power Off):** Set to display the clock when the system power is off.
- **Language:** You can change the display language.

Rewinding/Fast forwarding

On the control panel, press and hold the **[< SEEK] button / [TRACK >]** button.

- You can also push and hold the Up/Down lever on the steering wheel.

Restarting the current playback

On the control panel after the song has played for 2 seconds, press the **[< SEEK]** button.

- You can also push the Up lever on the steering wheel.

Playing the previous or next song

To play the previous song on the control panel within the first 2 seconds of the current song, press the **[< SEEK]** button.

To play the next song, press the **[TRACK >]** button on the control panel.

- If more than 2 seconds of playback have elapsed, press the **[< SEEK]** button on the control panel twice to play the previous song.
- You can also push the Up/Down lever on the steering wheel.

*** NOTICE**

Press the **[MENU/CLOCK]** button on the control panel to display the mode selection window, turn the **[TUNE]** knob to find the desired song and press the knob to play the song.

Playing repeatedly

On the control panel, press the [1 RPT] button. The repeat play mode changes each time you press it. The corresponding mode icon will be displayed on the screen and the playing song will be repeated.

Playing in random order

On the control panel, press the [2 SHFL] button. The shuffle play mode is activated or deactivated each time you press it. When you activate the shuffle mode, the corresponding mode icon will be displayed on the screen. When shuffle is active, the available songs will be played randomly.

Searching folders

1. On the control panel, press the [MENU/CLOCK] button.
2. When the option selection window displays, turn the [TUNE] knob to select the **Folder list** and then press the knob.
3. Navigate to the desired folder in the **Folder list** and then press the [TUNE] knob.
 - The first song in the selected folder will be played.

⚠ CAUTION

- Start the engine of your vehicle before connecting a USB device to your system. Starting the engine with a USB device connected to the system may damage the USB device.
- Be careful of static electricity when connecting or disconnecting a USB device. A static discharge may cause a system malfunction.
- Be careful not to let your body or external objects contact the USB port.

Doing so may cause an accident or a system malfunction.

- Do not connect and disconnect a USB connector repeatedly in a short time. Doing so may cause an error in the device or a system malfunction.
- Do not use a USB device for purposes other than playing files. Using USB accessories for charging or heating may cause poor performance or a system malfunction.

* NOTICE

- When connecting a USB storage device, do not use an extension cable. Connect it directly to the USB port. If you use a USB hub or an extension cable, the device may not be recognised.
- Fully insert a USB connector into the USB port. Failure to do so may cause a communication error.
- When you disconnect a USB storage device, a distorted noise may occur.
- The system can play only files encoded in a standard format.
- The following types of USB devices may not be recognised or work correctly:
 - Encrypted MP3 players
 - USB devices not recognised as removable disks
- A USB device may not be recognised depending on its condition.
- Some USB devices may be incompatible with your system.
- Depending on the USB device's type, capacity, or the format of files, USB recognition time may be longer.
- Image and video playback are not supported.

Bluetooth

Connecting Bluetooth devices

Bluetooth is a short-range wireless networking technology. Via Bluetooth, you can connect nearby mobile devices wirelessly to send and receive data between connected devices. This enables you to use your devices effectively.

To use Bluetooth, you must first connect a Bluetooth-enabled device to your system, such as a mobile phone or an MP3 player. Ensure that the device you want to connect supports Bluetooth.

WARNING

Park your vehicle in a safe location before connecting Bluetooth devices. Distracted driving can cause a traffic accident and lead to personal injury or death.

NOTICE

- On your system, you can use only Bluetooth Handsfree and Audio features. Connect a mobile device that supports both features.
- Some Bluetooth devices may cause malfunctions to the infotainment system or make interference noises. In this case, storing the device in a different location may resolve the problem.
- Depending on the connected Bluetooth device or mobile phone, some functions may not be supported.
- If the system is not stable due to a vehicle-Bluetooth device communication error, delete the paired devices and connect the Bluetooth devices again.
- If Bluetooth connection is not stable, follow these steps to try again.

1. Deactivate Bluetooth and reactivate it on the device. Then, reconnect the device.
 2. Turn the device off and on. Then, reconnect it.
 3. Remove the battery from the device and reinstall it. Then, turn the device on and reconnect it.
 4. Unregister the Bluetooth pairing on both the system and the device and then re-register and connect them.
- The Bluetooth connection is unavailable when the device's Bluetooth function is turned off. Be sure to turn on the device's Bluetooth function.

Pairing devices with your system

For Bluetooth connections, first pair your device with your system to add it to the system's list of Bluetooth devices. You can register up to five devices.

1. From the control panel, press the **[PHONE]** button, and then select **Phone settings ► Add new device**.
 - If you are pairing a device with your system for the first time, or if there are no connected devices than you can also press the Call/Answer button on the steering wheel to initiate pairing.
2. On the Bluetooth device you want to connect, activate Bluetooth, search for your vehicle's system, and then select it.
 - Check the system's Bluetooth name, which is displayed in the new registration pop-up window on the system screen.



3. Enter or confirm the passkey to confirm the connection.
 - If the passkey input screen is displayed on the Bluetooth device screen, enter the passkey '0000' which is displayed on the system screen.
 - If the 6-digit passkey is displayed on the Bluetooth device screen, ensure that the Bluetooth passkey displayed on the Bluetooth device is the same as the passkey on the system screen and confirm the connection from the device.

*** NOTICE**

- The screen image in this manual is an example. Check your system screen for the exact vehicle name and Bluetooth device name.
- The default passkey is '0000'.
- It may take a Whilst for the system to connect with the device after you permit the system to access the device. When a connection is made, the Bluetooth status icon appears at the top of the screen.
- You can change the permission settings via the mobile phone's Bluetooth settings menu. For more information, refer to your mobile phone's user guide.
- To register a new device, repeat steps 1 to 3.
- If you use the automatic Bluetooth connection function, a call may be switched to the vehicle's Handsfree

when you are taking on the phone near the vehicle Whilst the vehicle's engine is on. If you do not want the system to connect with the device automatically, deactivate Bluetooth on your device.

- When a device is connected to the system via Bluetooth, the device's battery may discharge faster.

Connecting a paired device

To use a Bluetooth device on your system, connect the paired device to the system. Your system can connect with only one device at a time.

1. From the control panel, press the **[PHONE]** button, and then select **Phone settings ► Paired devices.**
 - If there is no connected device, press the Call/Answer button on the steering wheel to start pairing.
2. Turn the **[TUNE]** knob to select the device to connect, and then press the knob.
 - If another device is already connected to your system, disconnect it. Select the connected device to disconnect.

*** NOTICE**

- If a connection ends because a device is out of the connection range or a device error occurs, the connection will be restored automatically when the device enters the connection range or when the error is cleared.
- Depending on auto connection priority, connection to a device may take time.

Disconnecting a device

If you want to stop using a Bluetooth device or connect another device, disconnect your currently connected device.

1. From the control panel, press the [PHONE] button, and then select **Phone settings ► Paired devices**.
2. Turn the [TUNE] knob to select your currently connected device and then press the knob.
3. Press the [1 RPT] button to select **Yes**.

Deleting paired devices

If you no longer want a Bluetooth device paired or if you want to connect a new device when the Bluetooth device list is full, delete paired devices.

1. From the control panel, press the [PHONE] button, and then select **Phone settings ► Delete devices**.
2. Turn the [TUNE] knob to select the device to delete, and then press the knob.
3. Press the [1 RPT] button to select **Yes**.

* NOTICE

- When you delete a paired device, the Call history and Contacts stored in the system are also deleted.
- To re-use a deleted device, you must pair the device again.

Using a Bluetooth audio device

You can listen to music stored in the connected Bluetooth audio device via your vehicle's speakers.

1. On the control panel, press the [AUDIO] button.
2. When the mode selection window displays, turn the [TUNE] knob to select **BT Audio** and then press the knob.



1. Information about the song currently playing

Press the [MENU/CLOCK] button on the control panel to access the following a menu option.

- **Sound settings:** You can change the settings related to sounds, such as location where sound will be concentrated and the output level for each range.
 - **Position:** Select a location where sound will be concentrated in the vehicle. Select **Fader** or **Balance**, turn the [TUNE] knob to select the desired position, and then press the knob. To set sound to be centred in the vehicle, select **Centre (Center)**.
 - **Equaliser (Tone):** Adjust the output level for each sound tone mode.
 - **Sound experience:** (if equipped) select the location where sound is focused in the vehicle between the driver's seat and all other seats.
 - **Speed dependent vol.:** Set the volume to be adjusted automatically according to your driving speed.

* NOTICE

- Depending on vehicle models or specifications, available options may vary.
 - Depending on the system or amplifier specifications applied to your vehicle, available options may vary.
-
- **Mode popup:** Set to display mode selection window when the [MEDIA] button is pressed on the control panel.

- **Date/Time:** You can change the date and time that are shown on the system display.
 - **Set date:** Set date to display on the system display.
 - **Set time:** Set time to display on the system display.
 - **Time format:** Select to display time in the 12 hour format or the 24 hour format.
 - **Display (Power Off):** Set to display the clock when the system power is off.
- **Language:** You can change the display language.

Pausing/Resuming playback

To pause playback, press the [TUNE] knob on the control panel. To resume playback, press the [TUNE] knob again.

- You can also press the Mute button on the steering wheel remote control.

Playing repeatedly

On the control panel, press the [1 RPT] button. The repeat play mode changes each time you press it. The corresponding mode icon will be displayed on the screen and the current playing song will be repeated.

Playing in random order

On the control panel, press the [2 SHFL] button. The shuffle play mode is activated or deactivated each time you press it. When you activate the shuffle mode, the corresponding mode icon will be displayed on the screen. When shuffle is active, the available songs will be played randomly.

* NOTICE

- Depending on the music player you are using, playback controls may differ.
- Depending on the music player you are using, streaming may not be supported.
- Depending on the connected Bluetooth device or mobile phone, some functions may not be supported.
- If a Bluetooth enabled phone is being used to play music and it receives or makes a phone call, the music will stop.
- Receiving an incoming call or making an outgoing call whilst playing Bluetooth audio may result in audio interference.
- If you use the Bluetooth phone mode whilst using Bluetooth audio, playback may not automatically resume after you end the call depending on the connected mobile phone.
- Moving the track up/down whilst playing Bluetooth audio mode may result in pop noises with some mobile phones.
- The Rewinding/Fast forwarding function is not supported in the Bluetooth audio mode.
- The playlist feature is not supported in the Bluetooth audio mode.
- If the Bluetooth device is disconnected, Bluetooth audio mode will end.
- Depending on the connected Bluetooth device or mobile phone, repeat & shuffle order features may not be supported.

Using a Bluetooth phone

You can use Bluetooth to talk on the phone hands free. View call information on the system screen, and make or receive calls safely and conveniently via the vehicle's built-in microphone and speakers.

WARNING

- Park your vehicle in a safe location before connecting Bluetooth devices. Distracted driving can cause a traffic accident and lead to personal injury or death.
- Never dial a phone number or pick up your mobile phone whilst driving. Use of a mobile phone may distract your attention, making it difficult to recognise external conditions and reducing the ability to cope with unexpected situations, which may lead to an accident. If necessary, use the Bluetooth Handsfree feature to make calls and keep the call as short as possible.

NOTICE

- You cannot access the Phone screen if there is no connected mobile phone. To use the Bluetooth phone function, connect a mobile phone to the system.
- The Bluetooth Handsfree function may not work when you are passing out of the cellular service coverage area, such as when you are in a tunnel, underground, or in a mountainous area.
- Call quality may be degraded in the following environments:
 - The reception of the mobile phone is poor.
 - The inside of the vehicle is noisy.

- The mobile phone is placed near metallic objects, such as a beverage can.
- Depending on the connected mobile phone, the volume and sound quality of the Bluetooth Handsfree may vary.

Making a call

If your mobile phone is connected to the system, you can make a call by selecting a name from your call history or contacts list.

1. On the control panel, press the **[PHONE]** button.
 - Alternatively, press the Call/Answer button on the steering wheel.
2. Select a phone number.
 - To select a phone number from your favourites list, select **Favourites**.
 - To select a phone number from your call history, select **Call history**.
 - To select a phone number from the contacts list downloaded from the connected mobile phone, select **Contacts**.
3. To end the call, press the **[2 SHFL]** button on the control panel.
 - Alternatively, press the Call end button on the steering wheel.

Registering the favourites list

You can more easily use Bluetooth to talk on the phone hands-free by registering phone numbers as your favourites.

1. On the Phone screen, turn the **[TUNE]** knob on the control panel to select **Favourites**, and press the knob.
2. Select **[MENU] ► Add new favourites**.

3. Turn the [TUNE] knob to select the desired group of alphanumeric characters, and then press the knob.
4. Turn the [TUNE] knob to select the desired contact.

Using the favourites list

1. From the Phone screen, turn the [TUNE] knob on the control panel to select **Favourites**, and then press the knob.
2. Turn the [TUNE] knob to select the desired contact, and then press the knob to make a phone call.

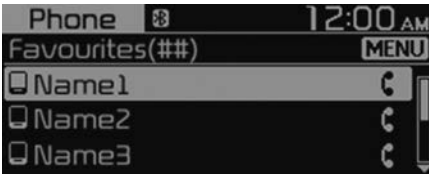

Press the [MENU/CLOCK] button on the control panel to access the following menu options:

- **Add new favourites:** Add a frequently used phone number to favourites.
- **Delete items:** Delete a selected favourites item.
- **Delete all:** Delete all favourites items.

* NOTICE

- You can register up to 20 favourites for each device.
- You must first download the contacts to the system to register favourites.
- The favourites list saved on the mobile phone is not downloaded to the system.
- Even if the contact information on the mobile phone is edited, the favourites on the system are not automatically edited. Delete and add the item to favourites again.

- When you connect a new mobile phone, your favourites set for the previous mobile phone will not be displayed, but they will remain in your system until you delete the previous phone from the device list.

Using your call history

1. From the Phone screen, turn the [TUNE] knob on the control panel to select **Call history**, and then press the knob.
2. Turn the [TUNE] knob to select the desired entry, and then press the knob to make a phone call.

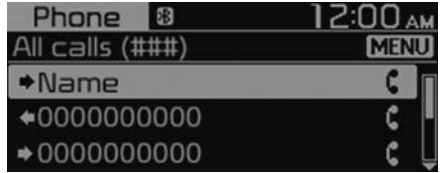

Press the [MENU] button on the control panel to access the following menu options:

- **Download:** Download your call history.
- **All calls:** View all call records.
- **Dialled calls:** View only dialled calls.
- **Received calls:** View only received calls.
- **Missed calls:** View only missed calls.

* NOTICE

- Some mobile phones may not support the download function.
- The call history is accessed only after downloading the call history when the mobile phone is connected to the system.
- Calls from restricted IDs are not saved on the call history list.

- Up to 50 call records will be downloaded per individual list.
- Call duration and time information will not be displayed on the system screen.
- Permission is required to download your call history from the mobile phone. When you attempt to download data, you may need to permit the download on the mobile phone. If the download fails, check the mobile phone screen for any notification or the mobile phone's permission setting.
- When you download your call history, any old data will be deleted.

Using the contacts list

1. From the Phone screen, turn the [TUNE] knob on the control panel to select **Contacts**, and then press the knob.
2. Turn the [TUNE] knob to select the desired group of alphanumeric characters, and then press the knob.
3. Turn the [TUNE] knob to select the desired contact, and then press the knob to make a phone call.



Press the [MENU] button on the control panel to access the following a menu option:

- **Download:** Download your mobile phone contacts.

*** NOTICE**

- Contacts can be viewed only when the Bluetooth device is connected.

- Only contacts in the supported format can be downloaded and displayed from the Bluetooth device. Contacts from some applications will not be included.
- Up to 2,000 contacts can be downloaded from your device.
- Some mobile phones may not support the download function.
- Depending on the system's specifications, some of the downloaded contacts may be lost.
- Contacts stored both in the phone and in the SIM card are downloaded. With some mobile phones, contacts in the SIM card may not be downloaded.
- Special characters and figures used in the contact name may not be displayed properly.
- Permission is required to download contacts from the mobile phone. When you attempt to download data, you may need to permit the download on the mobile phone. If the download fails, check the mobile phone screen for any notification or the mobile phone's permission setting.
- Depending on the mobile phone type or status, downloading may take longer.
- When you download your contacts, any old data will be deleted.
- You cannot edit or delete your contacts on the system.
- When you connect a new mobile phone, your contacts downloaded from the previous mobile phone will not be displayed, but they will remain in your system until you delete the previous phone from the device list.

Answering calls

When a call comes in, a notification pop-up window of the incoming call appears on the system screen.



To answer the call, press the [1 RPT] button on the control panel.

- Alternatively, press the Call/Answer button on the steering wheel.

To reject the call, press the [2 SHFL] button on the control panel.

- Alternatively, press the Call end button on the steering wheel.

* NOTICE

- Depending on the mobile phone type, call rejection may not be supported.
- Once your mobile phone is connected to the system, the call sound may be output through the vehicle's speakers even after you exit the vehicle if the phone is within the connection range. To end the connection, disconnect the device from the system or deactivate Bluetooth on the device.

Using options during a call

During active call, you will see the call screen shown below. Press a button to perform the function you want.

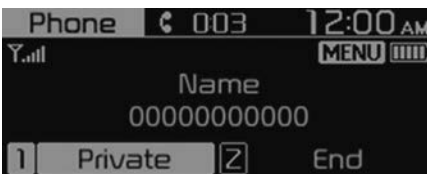

To switch the call to your mobile phone, press the [1 RPT] button on the control panel.

- Alternatively, press and hold the Call/Answer button on the steering wheel.

Press [1 RPT] again during private mode to change call from private mode to Use hands-free.

To end the call, press the [2 SHFL] button on the control panel.

- Alternatively, press the Call end button on the steering wheel.

Press the [MENU] button on the control panel to access the following a menu option:

- **Microphone Volume (Outgoing Volume):** Adjust the microphone volume or turn off the microphone so the other party cannot hear you.

* NOTICE

- If the caller information is saved in your contacts list, the caller's name and phone number will be displayed. If the caller information is not saved in your contacts list, only the caller's phone number will be displayed.
- You cannot switch to any other screen, such as the audio screen or the settings screen, during a Bluetooth call.
- Depending on the mobile phone type, call quality may vary. On some phones, your voice may be less audible to the other party.
- Depending on the mobile phone type, the phone number may not be displayed.
- Depending on the mobile phone type, the call switching function may not be supported.

THE EMERGENCY CALL SERVICE (if equipped)

You can make an emergency call quickly in the event of a traffic accident via the emergency call system.

- Public Safety Answering Point (PSAP) emergency call service

SOS

Driver or passenger manually can make an emergency call in the single duty dispatch service, by pressing SOS button to call the necessary emergency services.

- Stops sound and SOS is displayed on screen.

* NOTICE

- For more information, refer to the “What to do in an emergency” in manual.
- Depending on your region, the service may not be supported.
- Depending on your region or vehicle model, the name of the button may vary.

System status icons

Status icons appear at the top of the screen to display the current system status.

Familiarise yourself with the status icons that appear when you perform certain actions or functions and their meanings.



Bluetooth

| Icon | Description |
|------|--|
| | Battery level of connected Bluetooth device |
| | Mobile phone or audio device connected via Bluetooth |
| | Bluetooth call in progress |
| | Microphone turned off during Bluetooth call |
| | Downloading call history from a mobile phone connected via Bluetooth to the system |
| | Downloading contacts from a mobile phone connected via Bluetooth to the system |

Signal strength

| Icon | Description |
|------|---|
| | Signal strength of the mobile phone connected via Bluetooth |

* NOTICE

- The battery level displayed on the screen may differ from the battery level displayed on the connected device.
- The signal strength displayed on the screen may differ from the signal strength displayed on the connected mobile phone.
- Depending on vehicle models and specifications, some status icons may not be displayed.

System specifications

USB

Supported audio formats

- Audio file specification
 - WAVEform audio format
 - MPEG1/2/2.5 Audio Layer3
 - Windows Media Audio Ver 7.X/8.X
- Bit rates
 - MPEG1 (Layer3): 32/40/48/56/64/80/96/112/128/160/192/224/256/320 kbps
 - MPEG2 (Layer3): 8/16/24/32/40/48/56/64/80/96/112/128/144/160 kbps
 - MPEG2.5 (Layer3): 8/16/24/32/40/48/56/64/80/96/112/128/144/160 kbps
 - WMA (High Range): 48/64/80/96/128/160/192 kbps
- Bits Per Sample
 - WAV (PCM(Stereo)): 24 bit
 - WAV (IMA ADPCM): 4 bit
 - WAV (MS ADPCM): 4 bit
- Sampling frequency
 - MPEG1: 44100/48000/32000 Hz
 - MPEG2: 22050/24000/16000 Hz
 - MPEG2.5: 11025/12000/8000 Hz
 - WMA: 32000/44100/48000 Hz
 - WAV: 44100/48000 Hz
- Maximum length of folder/file names (Based on Unicode): 40 English or Korean characters
- Supported characters for folder/file names (Unicode support): 2,604 Korean characters, 94 alphanumeric characters, 4,888 Chinese characters in common use, 986 special characters

- Maximum number of folders: 1,000
- Maximum number of files: 5,000

* NOTICE

- Files that are not in a supported format may not be recognised or played, or information about them, such as the file name, may not be displayed properly.
- Only files with .mp3/.wma/.wav extensions can be recognised by the system. If the file is not in supported format, change the file format by using the latest encoding software.
- The device will not support files locked by DRM(Digital Rights Management).
- For MP3/WMA compression files and WAV file, differences in sound quality will occur depending on the bitrate. (Music files with a higher bitrate have a better sound quality.)
- Japanese or Simplified Chinese characters in folder or file names may not be displayed properly.

Supported USB storage devices

- Byte/Sector: 64 kbyte or less
- Format system: FAT12/16/32 (recommended), exFAT/NTFS

* NOTICE

- Operation is guaranteed only for a metal cover type USB storage device with a plug type connector.
 - USB storage devices with a plastic plug may not be recognised.
 - USB storage devices in memory card types, such as CF card or SD cards, may not be recognised.
- USB hard disk drives may not be recognised.

- When you use a large capacity USB storage device with multiple logical drives, only files stored on the first drive will be recognised.
 - If an application program is loaded on a USB storage device, the corresponding media files may not play.
 - Use USB 2.0 devices for better compatibility.
-

Bluetooth

- Bluetooth Power Class 2: -6 to 4 dBm
- Aerial power: Max 3 mW
- Frequency range: 2400 to 2483.5 MHz
- Bluetooth patch RAM software version: 1

Trademarks

Other trademarks and trade names are those of their respective owners.

- The Bluetooth® word mark and logos are registered trademarks owned by Bluetooth SIG, Inc. and any use of such marks by KIA is under licence.



Declaration of Conformity

UKCA

UKCA Declaration of Conformity

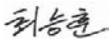

| Product details | |
|---|---|
| Product | DIGITAL CAR AUDIO SYSTEM |
| Model | AU210GYMG, AU210GYGG, AU210GYGN, AU210GYGP, AU210GYEG, AU210GYEP, AU211GYEP, AU212GYGL, AU211GYGG, AU210GYBB, AU211GYMG |
| Additional Information | SW: 1.0, HW: 1.0 |
| We hereby declare conformity with the relevant UK statutory requirement, Radio Equipment Regulations 2017. This declaration of conformity is issued under the sole responsibility of the manufacturer. | |
| Applied Standards | |
| Regulation 6(2) Spectrum | EN 300 328 V2.2.2 EN 303 345-1 V1.1.1 EN 303 345-2 V1.1.1 DRAFT EN 303 345-3 V1.1.0 DRAFT EN 303 345-4 V1.1.0 |
| Regulation 6(1)(b) EMC | EN 301 489-1 V2.2.3 EN 301 489-17 V3.2.4 EN 55032:2015 EN 55035:2017 |
| Regulation 6(1)(a) Safety | EN IEC 62368-1:2020+A11:2020 EN 62311:2008 |
| Manufacturer | |
| HYUNDAI MOBIS Co., Ltd. | |
| 203, Teheran-ro, Gangnam-gu, | |
| Seoul, 06141, Korea | |
| Tel: +82-31-260-2707 | |
| APPROVED BODY | |
| SGS United Kingdom Limited | |
| Unit 12A/12B, Bowburn South Industrial Estate | |
| Bowburn, Durham, DH6 5AD, United Kingdom | |
| APPROVED BODY Identification | 0120 |
| Reference | RER-0140 |
| Representative in the UK | |
| MOBIS Parts Europe N.V. | |
| Ansley Hall Drive, Birch Coppice Business Park | |
| Dordon, Tamworth. B78 1SQ, United Kingdom | |
| Tel: +44(0)-1827-266-740 | |
| Signed By ⁽¹⁴⁾ | 17/09/2021 |
| This declaration of conformity is issued under the sole responsibility of the manufacturer. ⁽¹⁴⁾ | |
|  | Seunghoon Choe Representative Hyundai MOBIS Co., Ltd. |



CE

EU Declaration of Conformity ^[1]



| Product details ^[2] | |
|---|---|
| Product ^[3] | DIGITAL CAR AUDIO SYSTEM |
| Model ^[4] | AU211TYMG, AU210TYGG, AU211TYGG, AU212TYGG, AU213TYGG, AU214TYGG, AU210TYGN, AU211TYGN, AU210TYGL, AU210TYGP, AU211TYGP, AU210TYMG, AU210TYEG, AU211TYEG, AU210TYEP, AU210TYGU, AU212TYEG, AU213TYEG, AU211TYEP, AU215TYEG, AU216TYEG, AU217TYEG, AU218TYEG, AU214TYEP, AU215TYEP |
| We hereby declare, that the product above is in compliance with the essential requirements of the Directive 2014/53/EU by application of ^[5] | |
| Applied Standards ^[6] | |
| Article ^[7] 3.2 | EN 300 328 V2.2.2 |
| Radio ^[8] | EN 303 345-1 V1.1.1 |
| | EN 303 345-2 V1.1.1 |
| | EN 303 345-3 V1.1.1 |
| | EN 303 345-4 V1.1.1 |
| Article ^[7] 3.1b | EN 301 489-1 V2.2.3 |
| EMC ^[9] | EN 301 489-17 V3.2.4 |
| | EN 55032:2015/A11:2020 |
| | EN 55035:2017/A11:2020 |
| Article ^[7] 3.1a | EN IEC 62368-1:2020+A11:2020 |
| Safety ^[10] , Health ^[11] | EN 62311:2008 |
| Manufacturer ^[12] | |
| HYUNDAI MOBIS Co., Ltd. | |
| 203, Teheran-ro, Gangnam-gu, | |
| Seoul, 06141, Korea | |
| Tel: +82-31-260-2707 | |
| Notified Body ^[14] | |
| SGS Fimko Ltd | |
| Takomotie 8 FI-00380 | |
| Helsinki, Finland | |
| Notified Body Identification ^[17] | 0598 |
| Reference ^[18] | RED-2731 |
| Additional information ^[19] | |
| SW: 1.0, HW: 1.0 | |

| Representative in the EU ^[13] | |
|---|-----------------------|
| MOBIS Parts Europe N.V. | |
| Wilhelm-Fay-Strabe 51, | |
| Frankfurt Main, 65936, Germany | |
| Tel: +49-69-85096-5011 | |
| Signed By ^[15] | |
| | 10 Sep 2021 |
| This declaration of conformity is issued under the sole responsibility of the manufacturer. ^[16] | |
|  | Seunghoon Choe |
| | Representative |
| | Hyundai MOBIS Co., Lt |

NCC

又得審驗證明之低功率射頻器材，非經核准，公司、商號或使用者均不得擅自變更頻率、加大功率或變更原設計之特性及功能。

低功率射頻器材之使用不得影響飛航安全及干擾合法通信；經發現有干擾現象時，應立即停用；並改善至無干擾時方得繼續使用。

前述合法通信，指依電信管理法規定作業之無線電通信。低功率射頻器材須忍受合法通信或工業、科學及醫療用電波輻射性電機設備之干擾。

7.9.1應避免影響附近雷達系統之操作。

7.9.2高增益指向性天線只得應用於固定式點對點系統

BSMI

| | | | | | | |
|---|--|------------------|------------------|--|--|--|
| 設備名稱：藍牙汽車音響 · 型號（型式）： AU210GYEG | | | | | | |
| 單元 Unit | 限用物質及其化學符號 Restricted substances and its chemical symbols | | | | | |
| | 鉛Lead (Pb) | 汞Mercury (Hg) | 鎘Cadmium (Cd) | 六價鉻 Hexavalent chromium (Cr ⁺⁺) | 多溴聯苯 Polybrominated biphenyls (PBB) | 多溴二苯醚 Polybrominated diphenyl ethers (PBDE) |
| 外觀組件 | ○ | ○ | ○ | ○ | ○ | ○ |
| 電路板組件 | ○ | ○ | ○ | ○ | ○ | ○ |
| 膠框組件 | ○ | ○ | ○ | ○ | ○ | ○ |
| 面板組件 | ○ | ○ | ○ | ○ | ○ | ○ |
| 螺絲組件 | ○ | ○ | ○ | ○ | ○ | ○ |
| 備考1. “超出0.1 wt %”及“超出0.01 wt %”係指限用物質之百分比含量超出百分比含量基準值。 Note 1: “Exceeding 0.1 wt %” and “exceeding 0.01 wt %” indicate that the percentage content of the restricted substance exceeds the reference percentage value of presence condition. | | | | | | |
| 備考2. “○”係指該項限用物質之百分比含量未超出百分比含量基準值。 Note 2: “○” indicates that the percentage content of the restricted substance does not exceed the percentage of reference value of presence. | | | | | | |
| 備考3. “-”係指該項限用物質為排除項目。 Note 3: The “-” indicates that the restricted substance corresponds to the exemption. | | | | | | |

ANATEL

“Este produto está homologado pela ANATEL, de acordo com os procedimentos regulamentados pela resolução nº. 242/2000 e atende aos requisitos técnicos e aplicados”

“Este equipamento não tem direito à proteção contra interferência prejudicial e não pode causar interferência em sistemas devidamente autorizados.”

Para maiores informações, consulte o site da ANATEL www.anatel.gov.br

Modelo AU210GYBB



TRA

| | |
|-------------------|-------------------|
| OMAN-TRA | OMAN-TRA |
| D192564 | D192564 |
| TRA/TA-R/11420/21 | TRA/TA-R/11422/21 |

NBTC



เครื่องวิทยุคมนาคมนี้ ด้รับยกเว้น ไม่ต้องได้
รับใบอนุญาตให้มี ใช้ซึ่งเครื่องวิทยุคมนาคม
หรือตั้งสถานีวิทยุคมนาคมตามประกาศ กสทช.
เรื่อง เครื่องวิทยุคมนาคม และสถานีวิทยุ
คมนาคมที่ด้รับยกเว้นไม่ต้องได้รับใบอนุญาต
วิทยุคมนาคมตามพระราชบัญญัติวิทยุคมนาคม
พ.ศ. 2498



nab. | โทรคมนาคม
กำกับดูแลเพื่อประชาชน
Call Center 1200 (InSW)

| | |
|--|-------------|
| Before driving | 6-3 |
| • Necessary vehicle inspections..... | 6-3 |
| • Good driving practices | 6-4 |
| • Good braking practices..... | 6-5 |
| Starting the vehicle | 6-6 |
| • Ignition switch..... | 6-6 |
| • ENGINE START/STOP button | 6-6 |
| • Starting the engine..... | 6-9 |
| Transmission | 6-10 |
| • Manual transmission | 6-10 |
| • Automatic transmission..... | 6-12 |
| • Dual clutch transmission..... | 6-15 |
| • LCD display messages..... | 6-19 |
| Paddle shifter | 6-24 |
| • Changing the shift mode..... | 6-24 |
| Brake system | 6-25 |
| • In the event of brake failure..... | 6-25 |
| • Parking brake | 6-26 |
| • AUTO HOLD | 6-31 |
| Vehicle safety system | 6-33 |
| • Anti-lock Brake System (ABS) | 6-33 |
| • Electronic Stability Control (ESC) | 6-33 |
| • Downhill Brake Control (DBC) | 6-34 |
| • Hill-start Assist Control (HAC) | 6-35 |
| • Multi-Collision Brake (MCB) | 6-35 |
| • Vehicle Stability Management (VSM)..... | 6-36 |
| • Emergency Stop Signal (ESS) | 6-36 |
| • Trailer Stability Assist (TSA)..... | 6-37 |
| • Brake Assistant System (BAS)..... | 6-37 |

6 Driving your vehicle

| | |
|---|-------------|
| Drive mode integrated control system | 6-38 |
| • DRIVE MODE | 6-38 |
| All Wheel Drive (AWD) system..... | 6-40 |
| • Terrain Mode | 6-40 |
| • 4WD Lock Mode | 6-40 |
| • Advantages of 4WD | 6-41 |
| • For safe 4WD operation..... | 6-41 |
| • Emergency precautions | 6-43 |
| Economical operation..... | 6-45 |
| Special driving conditions | 6-46 |
| Winter driving | 6-49 |
| Trailer towing | 6-53 |
| • Hitches | 6-54 |
| • Safety chains..... | 6-54 |
| • Trailer brakes..... | 6-55 |
| • Driving with a trailer | 6-55 |
| • Maintenance when trailer towing | 6-57 |
| • If you do decide to pull a trailer..... | 6-58 |
| Vehicle weight..... | 6-61 |
| • Base kerb weight | 6-61 |
| • Vehicle kerb weight | 6-61 |
| • Cargo weight..... | 6-61 |
| • GAW (Gross axle weight)..... | 6-61 |
| • GAWR (Gross axle weight rating) | 6-61 |
| • GVW (Gross vehicle weight) | 6-61 |
| • GVWR (Gross vehicle weight rating)..... | 6-61 |
| • Overloading..... | 6-61 |
| • Loading Your Vehicle | 6-61 |

Driving your vehicle

Before driving

Necessary vehicle inspections

Be sure to check the following fluid levels on a regular basis at the exact interval:

- Engine oil
- Engine coolant
- Brake fluid
- Washer fluid

For more details, refer to "Maintenance" on page 9-5.

WARNING

Focus on the road whilst driving. The driver's primary responsibility is in the safe and legal operation of the vehicle. Use of any handheld devices, other equipment or vehicle systems that distract the driver should not be used during vehicle operation.

Checking the exhaust system

Be sure the exhaust system does not leak.

The exhaust system should be checked whenever the vehicle is raised for oil replacement or for any other purpose. If you hear a change in the exhaust sound or if something strikes the undercarriage, Kia recommends to visit an authorised Kia dealer/service partner or a professional workshop and have the exhaust system checked as soon as possible.

WARNING

Do not inhale exhaust fumes or leave your engine running in an enclosed area for a prolonged time. Exhaust fumes contain carbon monoxide, a colourless

and odourless gas that can cause unconsciousness and death by asphyxiation.

Before entering vehicle

- Be sure that all windows, outside mirrors, and outside lights are clean.
- Check the condition of the tyres.
- Check under the vehicle for any sign of leaks.
- Be sure there are no obstacles behind you if you intend to back up.

Before starting vehicle

- Close and lock all doors.
- Position the seat so that all controls are easily reached.
- Buckle your seat belt.
- Adjust both inside and outside rear view mirrors.
- Be sure that all lights work.
- Check all gauges.
- Check the operation of warning lights when the vehicle is in the ON position.
- Release the parking brake and make sure the brake warning light is off.

WARNING

- When you intend to park or stop the vehicle with the engine on, be careful not to depress the accelerator pedal for a long period of time. It may overheat the engine or exhaust system and cause fire.
- Always check the surrounding areas near your vehicle for people, especially children, before putting a vehicle into D (Drive) or R (Reverse).
- Securely store items in your vehicle. When you make a sudden stop or turn the steering wheel rapidly, loose objects may drop on the floor and it

could interfere with the operation of the foot pedals, possibly causing an accident.

- Do not drive whilst under the influence of alcohol, drugs, or other impairing substances. Drinking and driving is dangerous. Even a small amount of alcohol will affect your reflexes, perceptions and judgment. Driving whilst under the influence of drugs or other impairing substances is as dangerous as or more dangerous than driving drunk.
- Always wear appropriate shoes when operating your vehicle. Unsuitable shoes (high heels, ski boots, sandals, etc.) may interfere with your ability to use the brake and accelerator pedals.

Good driving practices

- Never change the gear from P or N to any other position with the accelerator pedal depressed.
- Never change the gear into P when the vehicle is moving.
- Stop the vehicle completely before changing the gear into R or D.
- Never change the gear to N and coast down the hill. This is extremely hazardous. Always change the gear to R or D when the vehicle is moving.
- Do not "ride" the brakes. It may cause the brake to overheat and malfunction. Use the engine brake to drive down the long hill.
- Slow down before shifting to a lower gear.
- Always use the parking brake. Do not depend on P to keep the vehicle from moving.
- Exercise extreme caution when driving on a slippery surface. Be especially careful when braking, accelerating or shifting gears. The vehicle speed can change abruptly, causing the tyres to lose traction and the vehicle go out of control.
- Obtain the optimum vehicle performance by driving smoothly.

WARNING

- If your vehicle becomes stuck in snow, mud, sand, etc., then you may attempt to rock the vehicle free by moving it forward and backward. Do not attempt this procedure if people or objects are anywhere near the vehicle. During the rocking operation the vehicle may suddenly move forward or backward as it becomes unstuck, causing injury or damage to nearby people or objects.
- When driving uphill or downhill, always shift to D (Drive) for driving forward or shift to R (Reverse) for driving backwards, and check the gear position indicated on the cluster before driving. Driving in the opposite direction of the selected gear can lead to a dangerous situation by shutting off the engine and affecting the braking performance.
- Always buckle-up! In a collision, an unbelted occupant is significantly more likely to be seriously injured or killed than a properly belted occupant.
- Avoid high speeds when cornering or turning.
- Do not make quick steering wheel movements, such as sharp lane changes or fast, sharp turns.
- The risk of a rollover is greatly increased if you lose control of your vehicle at highway speeds.

- Losing control often occurs if two or more wheels drop off the roadway and the driver oversteers to reenter the roadway.
- In the event your vehicle leaves the roadway, do not steer sharply. Instead, slow down before pulling back into the travel lanes.
- Never exceed posted speed limits.
- Parking brake can freeze in the engaged position under certain conditions such as snow or ice around or near the rear brakes or if the brakes are wet.
If there is a risk that the parking brake may freeze, apply it only temporarily whilst you change the gear in P and block the rear wheels so the vehicle cannot roll. Then release the parking brake.

Good braking practices

- Be sure the parking brake is not engaged and the parking brake indicator light is off before driving.
- The vehicle will not stop as quickly if the brakes are wet. Apply the brakes lightly until the braking action returns to normal.
- Don't "ride" the brake pedal. Resting your foot on the brake pedal whilst driving can be dangerous because the brakes might overheat and lose their effectiveness. It also increases the wear of the brake components.
- If a tyre goes flat whilst driving, apply the brakes gently and keep the vehicle pointed straight-ahead whilst slowing down the vehicle. Pull the vehicle slowly and safely off the road and stop in a safe place.
- Be cautious when parking on a hill. Firmly engage the parking brake and change the gear in P.
- If your vehicle is facing downhill, turn the front wheels into the kerb to help keep the vehicle from rolling.
If your vehicle is facing uphill, turn the front wheels away from the kerb to help keep the vehicle from rolling.
- Block the wheels if there is no kerb or if it is required by other conditions to keep the vehicle from rolling.
- Do not hold the vehicle on an incline with the accelerator pedal. This can cause the transmission to overheat. Always use the brake pedal or parking brake.

Starting the vehicle

Ignition switch (if equipped)



- 1 LOCK
- 2 ACC
- 3 ON
- 4 START

Operation

1. LOCK
 - The ignition key can be removed.
2. ACC (Accessory)
 - The electrical accessories can be operated.
3. ON
 - The warning lights can be checked.
4. START
 - Turn the ignition switch to start the engine. The brake warning light can be checked.

Ignition key interlock system (if equipped)

The ignition key cannot be removed unless the vehicle is in P (Park).

⚠ WARNING

- Never turn the ignition switch to LOCK or ACC whilst the vehicle is moving. This would result in loss of directional control and braking function, which could cause an accident.
- Do not attach small purses, multiple keys, or any other heavy accessories to the driver's key chain used to start

the vehicle. This may cause the driver to accidentally make the key inserted in the vehicle to change the ignition position to the ACC position whilst the vehicle is moving thereby increasing the risk of an accident and causing the deactivation of several safety features.

- To avoid unexpected or sudden vehicle movement, never leave your vehicle if the gear is not locked in the P (Park) position and the parking brake is fully engaged. Before leaving the driver's seat, always make sure the gear is shifted to P (Park) position, set the parking brake fully and shut the engine off.

*** NOTICE**

If you leave the ignition switch to the ACC or ON position for a long time, the battery may discharge.

ENGINE START/STOP button (if equipped)



Operation

1. OFF
 - Press the ENGINE START/STOP button in P to turn the vehicle off.
2. ACC (Accessory)
 - Press the ENGINE START/STOP button once without depressing the brake pedal.
 - The steering wheel is unlocked.

- The electrical accessories can be operated.
 - Turns off automatically after approximately 1 hour to prevent battery discharge.
3. ON
- Press the ENGINE START/STOP button twice without depressing the brake pedal.
 - The warning lights can be checked.
4. START/RUN
- Press the ENGINE START/STOP button whilst depressing the brake pedal in P or N.
 - Start the engine in P for the safety.

WARNING

- Never press the ENGINE START/STOP button whilst the vehicle is in motion. This would result in loss of directional control and braking function, which could cause an accident.
- Before leaving the driver's seat, always make sure the gear is shifted to P (Park) position, set the parking brake fully and shut the engine off. Unexpected and sudden vehicle movement may occur if these precautions are not taken.
- Never reach for the ENGINE START/STOP button or any other controls through the steering wheel whilst the vehicle is in motion. The presence of your hand or arm in the area could cause loss of vehicle control, an accident and serious bodily injury or death.
- Do not place any movable objects around the driver's seat as they may move whilst driving, interfere with the driver and lead to an accident.

* NOTICE

- If you leave the ENGINE START/STOP button in the ACC or ON position for a long time, the battery will discharge.
- If you press the ENGINE START/STOP button without pressing the brake pedal, the engine will not start and the ENGINE START/STOP button changes as follow:
 - OFF → ACC → ON → OFF or ACC

ENGINE START/STOP button interlock system (if equipped)

The ENGINE START/STOP button will not change to the OFF position unless the vehicle is in P (Park).

Vehicles equipped with anti-theft steering column lock (if equipped)

The steering wheel is locked when:

- The vehicle is in the OFF position
- The doors are opened

CAUTION

In an emergency situation whilst the vehicle is in motion, you are able to turn the engine off and to the ACC position by pressing the ENGINE START/STOP button for more than 2 seconds or 3 times repeatedly within 3 seconds.

If the vehicle is still moving, to restart the vehicle:

- Press the ENGINE START/STOP button when vehicle speed is 5 km/h (3 mph) or over.

* NOTICE

- If the steering wheel doesn't unlock properly, the ENGINE START/STOP

button will not work. Press the ENGINE START/STOP button whilst turning the steering wheel right and left to release the tension.

- You are able to turn off the engine (START/RUN) or vehicle power (ON), only when the vehicle is not in motion.

Starting the engine with smart key

The vehicle will check for the smart key when:

- The vehicle doors are opened
- The ENGINE START/STOP button is pressed

If the smart key is not in the vehicle, the indicator () and the message will appear on the instrument cluster.

WARNING

The engine will start, only when the smart key is in the vehicle. Never allow children or any person who is unfamiliar with the vehicle touch the ENGINE START/STOP button or related parts. Pushing the ENGINE START/STOP button whilst the smart key is in the vehicle may result in unintended engine activation and/or unintended vehicle movement.

CAUTION

- If the engine stalls whilst the vehicle is in motion, do not attempt to move the gear to the P (Park) position. If the traffic and road conditions permit, you may put the gear in the N (Neutral) position whilst the vehicle is still moving and press the ENGINE START/STOP button in an attempt to restart the engine.

- Do not press the ENGINE START/STOP button for more than 10 seconds except when the stop lamp fuse is blown.
- Do not turn the ignition switch to the START position with the engine running. It may damage the starter.
- You can also start the engine when the gear is in the N (neutral) position, but for safety, be sure to start the engine only when the gear is in the P (Park) position.

* NOTICE

- If the battery is weak or the smart key does not work correctly, you can start the engine by pressing the ENGINE START/STOP button with the smart key. When you press the ENGINE START/STOP button directly with the smart key, the smart key should contact the button at a right angle.



- When the stop lamp fuse is blown, you cannot start the engine normally. Replace the fuse with a new one. If it is not possible, you can start the engine by pressing the ENGINE START/STOP button for 10 seconds whilst it is in the ACC position. The engine can start without pressing the brake pedal. But for your safety always press the brake pedal before starting the engine.

Starting the engine

⚠ WARNING

- Always wear appropriate shoes when operating your vehicle. Unsuitable shoes (high heels, ski boots, etc.) may interfere with your ability to use the brake and accelerator pedal.
- Do not start the vehicle with the accelerator pedal depressed. The vehicle can move and lead to an accident.
- Wait until the engine rpm is normal. The vehicle may suddenly move if the brake pedal is released when the rpm is high.

Starting the petrol engine

Operation

1. Make sure the parking brake is applied.
2. Make sure the gear is in P (Park).
3. Fully depress the brake pedal.
4. Turn the key to START position or press the ENGINE START/STOP button.

Starting the diesel engine

Operation

1. Make sure the parking brake is applied.
2. Make sure the gear is in P (Park).
3. Fully depress the brake pedal.
4. Turn the key to ON position or press the ENGINE START/STOP button. The glow indicator (🔌) will illuminate.
5. If the glow indicator (🔌) is turned off, turn the key to START position or fully depress the brake pedal until the engine is started.

*** NOTICE**

- If the engine does not start within 10 seconds after the preheating is completed, turn the ignition key once more to the LOCK position for 10 seconds, and then to the ON position, in order to preheat again.
- If the engine start/stop button is pressed once more whilst the engine is pre-heating, the engine may start.

Starting and stopping the turbocharged/intercooled engine (if equipped)

Operation

1. Idle the engine for a few seconds after turning the vehicle in START position to ensure the turbocharger is lubricated.
2. Idle the engine for approximately a minute before turning the vehicle in OFF position to allow the turbocharger to cool down.

⚠ WARNING

Wait until the engine rpm is normal. The vehicle may suddenly move if the brake pedal is released when the rpm is high.

⚠ CAUTION

- You can also start the engine when the gear is in the N (neutral) position, but for safety, be sure to start the engine only when the gear is in the P (Park) position.
- Do not turn the engine off immediately after it has been subjected to a heavy load. Doing so may cause severe damage to the engine or turbocharger unit.

- If the engine stalls whilst you are in motion, do not attempt to shift the gear to the P (Park) position. If traffic and road conditions permit, you may put the gear in the N (Neutral) position whilst the vehicle is still moving and turn the ignition switch to the START position in an attempt to restart the engine.
- Do not engage the starter for more than 10 seconds. If the engine stalls or fails to start, wait 5 to 10 seconds before re-engaging the starter. Improper use of the starter may damage it.
- Do not turn the ignition switch to the START position with the engine running. It may damage the starter.

* NOTICE

If your vehicle is equipped with a kick-down mechanism in the accelerator pedal, it prevents you from driving at full throttle unintentionally by making the driver require increased effort to depress the accelerator pedal.

Transmission

Manual transmission (if equipped)



⇨ The shift lever can be moved without pulling the button (1).

➡ The button (1) should be pressed when moving the shift lever into R (Reverse).

Operation

- Depress the clutch pedal down fully whilst shifting, then release it slowly.

Using the clutch

The clutch should be pressed all the way to the floor before shifting, then released slowly. The clutch pedal should always be fully released whilst driving. Do not rest your foot on the clutch pedal whilst driving. This can cause unnecessary wear. Do not partially engage the clutch to hold the vehicle on an incline.

This causes unnecessary wear. Use the foot brake or parking brake to hold the vehicle on an incline. Do not operate the clutch pedal rapidly and repeatedly.

Downshifting

When you must slow down in heavy traffic or whilst driving up steep hills, downshift before the engine starts to labour.

Downshifting reduces the chance of stalling and gives better acceleration when you again need to increase your speed. When the vehicle is travelling down steep hills, downshifting helps maintain safe speed and prolongs brake life.

* INFORMATION

- If your vehicle is equipped with an ignition lock switch, the engine will not start when starting the engine without depressing the clutch pedal.
- The shift lever must be returned to the neutral position before shifting into R (Reverse).

Push the button located immediately below the shift knob and pull the gearshift lever to the left sufficiently, and then shift into reverse (R) gear position.

- Make sure the vehicle is completely stopped before shifting into R (Reverse).
- Never operate the engine with the tachometer (rpm) in the red zone.
- During cold weather, shifting may be difficult until the transmission lubricant is warmed up. This is normal and not harmful to the transmission.
- If you've come to a complete stop and it's hard to shift into 1st or R (Reverse), leave the shift lever at N (Neutral) position and release the clutch. Press the clutch pedal back down, and then shift into 1st or R (Reverse) gear position.

⚠ WARNING

- Before leaving the driver's seat, always set the parking brake fully and shut the engine off. Then make sure the transmission is shifted into 1st gear when the vehicle is parked on a level or uphill grade, and shifted into R (Reverse) on a downhill grade. Unexpected and sudden vehicle movement can occur if these precautions are not followed in the order identified.
- Do not use the engine brake (shifting from a high gear to lower gear) rapidly on slippery roads. The vehicle may slip causing an accident.
- Depress the clutch pedal as far as possible. Be aware not to apply the pedal again before it returns to the normal position. If the pedal is repeatedly depressed before returning to its normal position, the clutch system might be damaged.
- Do not overload the vehicle. Starting or driving a vehicle in this situation generates too much frictional heat to the clutch disk which might cause damage to the clutch cover and disk.
- When starting the vehicle or driving backwards, releasing the clutch pedal too soon after shifting the lever might turn off the engine and lead to an accident.

⚠ CAUTION

- When downshifting from 5th gear to 4th gear, caution should be taken not to inadvertently press the shift lever sideways in such a manner that the second gear is engaged. Such a drastic downshift may cause the engine speed to increase to the point that the tachometer will enter the red-zone.

Such over-revving of the engine and transmission may possibly cause engine damage.

- Do not downshift more than 2 gears or downshift the gear when the engine is running at high speed (5,000 rpm or higher). Such downshifting may damage the engine, clutch and the transmission.
- To avoid premature clutch wear and damage, do not drive with your foot resting on the clutch pedal. Also, don't use the clutch to hold the vehicle stopped on an uphill grade, whilst waiting for a traffic light, etc.
- Do not use the shift lever as a handrest during driving, as this can result in premature wear of the transmission shift forks.
- To prevent possible damage to the clutch system, do not start with the 2nd gear engaged except when you start on a slippery road.
- When operating the clutch pedal, press the clutch pedal down fully. If you don't press the clutch pedal fully, the clutch may be damaged or noise may occur.

Automatic transmission (if equipped)

Shift lever type

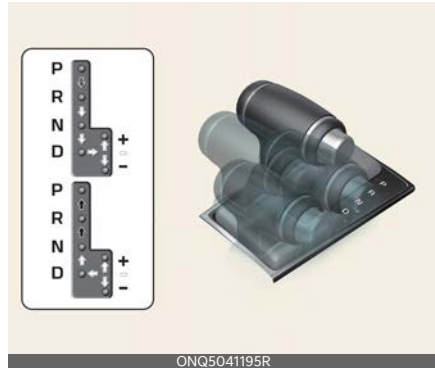

 Depress the brake pedal and the lock release button when shifting.

 Press the unlock button when shifting.

 The shift lever can be shifted freely.

- P (Park)
- R (Reverse)
- N (Neutral)
- D (Drive)

Operation

- Depress the brake pedal and shift the lever.

Manual mode



Operation

1. Push the shift lever from D (Drive) position into the manual gate.
 - Up (+): Push the lever forward once to shift up one gear.
 - Down (-): Pull the lever backwards once to shift down one gear.
2. Push the shift lever back into D (Drive) position to return to automatic mode.

Shift lock

Shift lock prevents shifting from P (Park) into R (Reverse) unless the brake pedal is depressed.

Operation

1. Depress and hold the brake pedal.
2. Turn the vehicle to the ON position.
3. Move the shift lever.

* INFORMATION

If the brake pedal is repeatedly depressed and released with the shift lever in the P (Park), a chattering noise near the shift lever may be heard. This is a normal condition.

Overriding shift lock

If the shift lever cannot be moved from the P (Park) position into R (Reverse) position.



Operation

1. Continue depressing the brake.
2. Turn the vehicle to the OFF position.

3. Make sure the parking brake is applied.
4. Carefully remove the shift knob boot.
5. Insert a tool (e.g. flathead screwdriver) into the access hole and press down on the tool.
6. Move the shift lever.
7. Remove the tool from the shift lock override access hole then install the knob boot.

Insert a screwdriver into the access hole and press down on the screwdriver.

Non-operating condition(s)

- Shift to N (Neutral) does no work within 3 minutes.
 - Carefully remove the shift knob boot.
 - Insert a tool (e.g. flathead screwdriver) into the access hole and press down on the tool.
 - Move the shift lever.
- Have the system checked by a professional workshop. Kia recommends to visit an authorised Kia dealer/service partner.

Parking in N (Neutral) gear

Follow below steps when parking and you want the vehicle to move when pushed.

1. After parking your vehicle, step on the brake pedal and move the shift lever to "P" with the ignition button in "ON" or whilst the engine is running.
2. If the parking brake is applied unlock the parking brake.
3. Whilst pressing the brake pedal, turn the ignition button "OFF". For smart key equipped vehicles, the ignition

switch can be moved to "OFF" only when the shift lever is in "P".

- Change the gear shift lever to "N" (Neutral) whilst pressing the brake pedal. Pull the shift lever boot, inserting, pressing down a tool (e.g., flat-head screw-driver) into the shift lock release access hole at the same time. Then, the vehicle will move when external force is applied.

⚠ CAUTION

- With the exception of parking in neutral gear, always park the vehicle in "P" (Park) for safety and engage the parking brake.
- Before parking in "N" (Neutral) gear, first make sure the parking ground is level and flat. Do not park in "N" gear on any slopes or gradients. If parked and left in "N", the vehicle may move and cause serious damage and injury.

Shift dial SBW type (if equipped)



- P (Park)
- R (Reverse)
- N (Neutral)
- D (Drive)

Operation

- Depress the brake pedal and turn the knob to the desired position.
- Turn the knob slightly to shift to N (Neutral).



N in vehicle ON position



Operation

- Deactivate AUTO HOLD and release the parking brake.
- Depress the brake pedal.
- Turn the shift dial to N (Neutral) and the message ("Press and hold OK button to stay in Neutral when vehicle is Off") will appear on the instrument cluster.
- Press and hold the OK button on the steering wheel for more than 1 second.
- Turn the engine off after the message ("Vehicle will stay in (N). Change gear to cancel") appears on the instrument cluster.

Operating condition(s)

- The vehicle is in ON position.

When the battery is discharged

Operation

- Connect the battery cables to the jump-starting terminals inside the engine compartment. For more

details, refer to "Jump-starting" on page 8-5.

2. Release the parking brake when the vehicle is in ON position.
3. Shift to N (Neutral).

Dual clutch transmission (if equipped)

Shift lever type

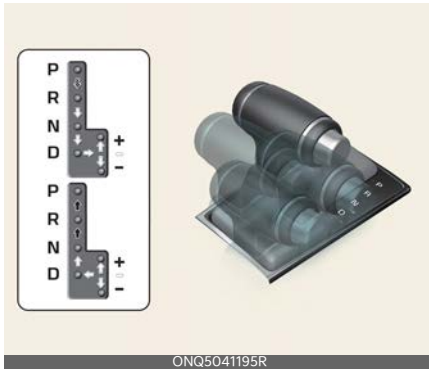

ONQ5041195R

 Depress the brake pedal and the lock release button when shifting.

 Press the unlock button when shifting.

 The shift lever can be shifted freely.

- P (Park)
- R (Reverse)
- N (Neutral)
- D (Drive)

Operation

- Depress the brake pedal and shift the lever.

Manual mode



ONQ5041197R

Operation

1. Push the shift lever from D (Drive) position into the manual gate.
 - Up (+): Push the lever forward once to shift up one gear.
 - Down (-): Pull the lever backwards once to shift down one gear.
2. Push the shift lever back into D (Drive) position to return to automatic mode.

Shift lock

Shift lock prevents shifting from P (Park) into R (Reverse) unless the brake pedal is depressed.

Operation

1. Depress and hold the brake pedal.
2. Turn the vehicle to the ON position.
3. Move the shift lever.

* INFORMATION

If the brake pedal is repeatedly depressed and released with the shift lever in the P (Park), a chattering noise near the shift lever may be heard. This is a normal condition.

Overriding shift lock

If the shift lever cannot be moved from the P (Park) position into R (Reverse) position.

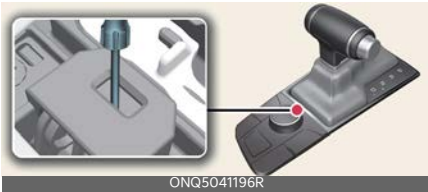

Operation

1. Continue depressing the brake.
2. Turn the vehicle to the OFF position.
3. Make sure the parking brake is applied.
4. Carefully remove the shift knob boot.
5. Insert a tool (e.g. flathead screwdriver) into the access hole and press down on the tool.
6. Move the shift lever.
7. Remove the tool from the shift lock override access hole then install the knob boot.
8. Have the system checked by a professional workshop. Kia recommends to visit an authorised Kia dealer/service partner.

Parking in N (Neutral) gear

Follow below steps when parking and you want the vehicle to move when pushed.

1. After parking your vehicle, step on the brake pedal and move the shift lever to "P" with the ignition button in "ON" or whilst the engine is running.
2. If the parking brake is applied unlock the parking brake.
3. Whilst pressing the brake pedal, turn the ignition button "OFF". For smart key equipped vehicles, the ignition switch can be moved to "OFF" only when the shift lever is in "P".
4. Change the gear shift lever to "N" (Neutral) whilst pressing the brake

pedal. Pull the shift lever boot, inserting, pressing down a tool (e.g., flat-head screw-driver) into the shift lock release access hole at the same time. Then, the vehicle will move when external force is applied.

⚠ CAUTION

- With the exception of parking in neutral gear, always park the vehicle in "P" (Park) for safety and engage the parking brake.
- Before parking in "N" (Neutral) gear, first make sure the parking ground is level and flat. Do not park in "N" gear on any slopes or gradients. If parked and left in "N", the vehicle may move and cause serious damage and injury.

Shift dial SBW type (if equipped)



- P (Park)
- R (Reverse)
- N (Neutral)
- D (Drive)

Operation

1. Depress the brake pedal and turn the knob to the desired position.
2. Turn the knob slightly to shift to N (Neutral).

Transmission ranges

The indicator in the instrument cluster displays the shift lever position when the ignition switch is in the ON position.



P (Park)

Always come to a complete stop before shifting into P (Park). To shift from P (Park), you must depress firmly on the brake pedal and make sure your foot is off the accelerator pedal. If you have done all of the above and still cannot shift the lever out of P (Park), see "Overriding shift lock" on page 6-15. The shift lever must be in P (Park) before turning the engine off.

N in vehicle ON position



Operation

1. Deactivate AUTO HOLD and release the parking brake.
2. Depress the brake pedal.
3. Turn the shift dial to N (Neutral) and the message will appear on the instrument cluster.
4. Press and hold the OK button on the steering wheel for more than 1 second.
5. Turn the engine off after the message appears on the instrument cluster.

Operating condition(s)

- The vehicle is in ON position.

When the battery is discharged

Operation

1. Connect the battery cables to the jump-starting terminals inside the engine compartment. For more details, refer to "Jump-starting" on page 8-5.
2. Release the parking brake when the vehicle is in ON position.
3. Shift to N (Neutral).

Characteristics of Dual clutch transmission

The dual clutch transmission has seven forward speeds and one reverse speed. The individual speeds are selected automatically when the shift lever is in the D (Drive) position.

- The dual clutch transmission can be thought of as an automatically shifting manual transmission. It gives the driving feel of a manual transmission, yet provides the ease of a fully automatic transmission.
- When D (Drive) is selected, the transmission will automatically shift through the gears similar to a conventional automatic transmission. Unlike a traditional automatic transmission, the gear shifting can sometimes be felt and heard as the actuators engage the clutches and the gears are selected.
- The dual clutch transmission incorporates a dry-type dual clutch mechanism, which allows for better acceleration performance and increased fuel efficiency whilst driving. But it differs from a conventional

automatic transmission because it does not incorporate a torque converter. Instead, the transition from one gear to the next is managed by clutch slip, especially at lower speeds.



As a result, shifts are sometimes more noticeable, and a light vibration can be felt as the transmission shaft speed is matched with the engine shaft speed. This is a normal condition of the dual clutch transmission.

- The dry-type clutch transfers torque more directly and provides a direct-drive feeling which may feel different from a conventional automatic transmission. This may be more noticeable when launching the vehicle from a stop or when travelling at low, stop-and-go vehicle speeds.
- When rapidly accelerating from a lower vehicle speed, the engine rpm may increase dramatically as a result of clutch slip as the dual clutch transmission selects the correct gear. This is a normal condition.
- When accelerating from a stop on an incline, press the accelerator smoothly and gradually to avoid any shudder feeling or jerkiness.
- When travelling at a lower vehicle speed, if you release the accelerator pedal quickly, you may feel engine braking before the transmission changes gears. This engine braking feeling is similar to operating a manual transmission at low speed.
- When driving downhill, you may wish to move the gear shift lever to Manual Shift mode and downshift to a lower gear in order to control your speed without using the brake pedal excessively.
- When you turn the engine on and off, you may hear clicking sounds as the system goes through a selftest. This is a normal sound for the dual clutch transmission.
- During the first 1,500 km (1000 miles), you may feel that the vehicle may not be smooth when accelerating at low speed. During this break-in period, the shift quality and performance of your new vehicle is continuously optimized.

LCD display messages

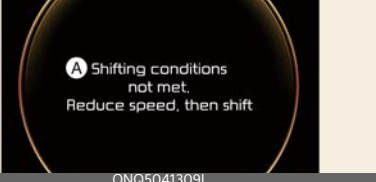
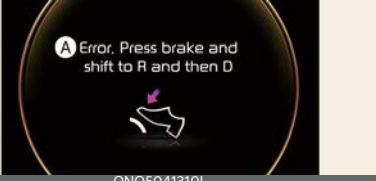
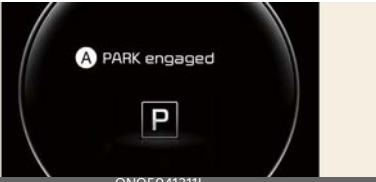
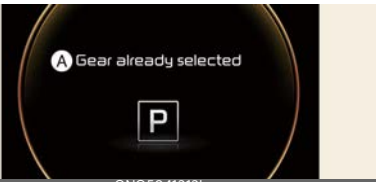
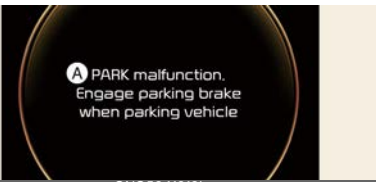
Shift dial SBW type of AT/DCT messages

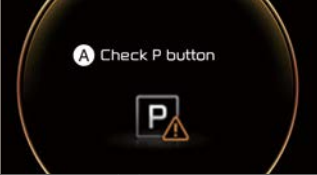
| Message | Content |
|---|--|
|  <p>A Shifting conditions not met. Reduce speed, then shift</p> <p>ONQ5041309L</p> | <p>A: Shifting conditions not met. Reduce speed, then shift</p> <ul style="list-style-type: none"> When driving speed is too fast to shift the gear. |
|  <p>A Error. Press brake and shift to R and then D</p> <p>ONQ5041310L</p> | <p>A: Error. Press brake and shift to R and then D</p> <ul style="list-style-type: none"> When the brake pedal is not depressed whilst shifting the gear. |
|  <p>A PARK engaged</p> <p>ONQ5041311L</p> | <p>A: PARK engaged</p> <ul style="list-style-type: none"> When the gear is shifted to P (Park) whilst the vehicle is moving. |
|  <p>A Gear already selected</p> <p>ONQ5041312L</p> | <p>A: This gear is already selected</p> <ul style="list-style-type: none"> When P (Park) is selected again or the gear is overheated. |
|  <p>A PARK malfunction. Engage parking brake when parking vehicle</p> <p>ONQ5041313L</p> | <p>A: PARK button error! Engage parking brake when parking vehicle</p> <ul style="list-style-type: none"> When there is a problem with function engaging P (Park) position. |

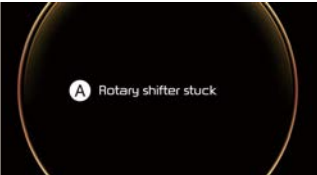
| Message | Content |
|--|---|
|  <p>ONQ504118L</p> | <p>A: Check P button</p> <ul style="list-style-type: none"> When there is a problem with there is problem with the P (Park) button. |
|  <p>ONQ5041314L</p> | <p>A: Check rotary gear shift dial</p> <ul style="list-style-type: none"> When there is problem with the shift dial. |
|  <p>ONQ5041316L</p> | <p>A: Rotary gear shift dial stuck</p> <ul style="list-style-type: none"> When the shift dial is continuously stuck or there is problem with the shift dial. |

DCT warning messages

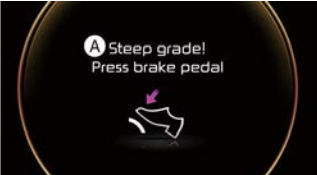
| Message | Content |
|---|--|
| <p>Steep grade</p>  <p>ONQ5041123L</p> | <p>A: Steep grade! Press brake pedal</p> <ul style="list-style-type: none"> To hold the vehicle on an incline use the foot brake or the parking brake. When in stop-and-go traffic on an incline, allow a gap to form ahead of you before moving the vehicle forward. Then hold the vehicle on the incline with the foot brake. If the vehicle is held on a hill by applying the accelerator pedal or by creeping with brake pedal disengaged, the clutch and transmission may overheat which can result in damage. At this time, a warning message will appear on the LCD display. If the LCD warning is active, the foot brake must be applied. Ignoring the warnings can lead to damage to the transmission. |

| Message | Content |
|---|---|
| <p>Transmission high temperature</p>  | <p>A: Transmission temp. is high! Stop safely</p> <ul style="list-style-type: none"> Under certain conditions, such as repeated stop-and-go launches on steep grades, sudden take off or acceleration, or other harsh driving conditions, the transmission clutch temperatures will increase excessively. Finally the clutch in transmission could be overheated. <p>* NOTICE</p> <ul style="list-style-type: none"> When driving in stop-and-go traffic, in stop condition, to reduce the driving stress and have better transmission operation move the shift lever to N (Neutral) or P (Parking) position. When the clutch is overheated, the safe protection mode engages and the gear position indicator on the cluster blinks with a chime. At this time, "Transmission temp. is high! Stop safely" warning message will appear on the LCD display and driving may not be smooth. If this occurs, pull over to a safe location, stop the vehicle with the engine running, apply the parking brake after shifting the vehicle to N (Neutral) with the brake pedal depressed, and allow the transmission to cool. If you ignore this warning, the driving condition may become worse. You may experience abrupt shifts, frequent shifts, or jerkiness. To return to the normal driving condition, stop the vehicle and apply the foot brake or shift into P (Park). Then allow the transmission to cool for a few minutes with engine on, before driving off. When possible, drive the vehicle smoothly. |
| <p>Transmission overheated</p>    | <p>A: Transmission Hot! Park with engine on B: Transmission cooling Park for 00 min. C: Trans cooled. Resume driving</p> <ul style="list-style-type: none"> If the vehicle continues to be driven and the clutch temperatures reach the maximum temperature limit, the "Transmission hot! Park with engine On" warning will be displayed. When this occurs the clutch is disabled until the clutch cools to normal temperatures. The warning will display a time to wait for the transmission to cool. If this occurs, pull over to a safe location, stop the vehicle with the engine running, apply the brakes and shift the vehicle to P (Park), and allow the transmission to cool. When the message "Trans cooled. Resume driving," appears you can continue to drive your vehicle. When possible, drive the vehicle smoothly. <p>If any of the warning messages in the LCD display continue to blink, for your safety, We recommend have the system checked by an authorised Kia dealer/service partner.</p> |

WARNING

To reduce the risk of serious injury or death:

- Always check the surrounding areas near your vehicle for people, especially children, before shifting a vehicle into D (Drive) or R (Reverse).
- Before leaving the driver's seat, always make sure the gear is in the P (Park) position; then set the parking brake, and place the ignition switch in the LOCK/OFF position. Unexpected and sudden vehicle movement can occur if these precautions are not followed.
- Always fully depress the brake pedal before and whilst shifting out of the P (Park) into another position to avoid inadvertent motion of the vehicle which could injure persons in or around the vehicle.
- After the vehicle has stopped, always make sure the gear is in P (Park), apply the parking brake, and turn the vehicle off.
- Do not use the P (Park) position in place of the parking brake. Always make sure the gear is in P (Park) position and set the parking brake fully.
- Never leave a child unattended in a vehicle.
- Do not drive with the gear in N (Neutral). The engine brake will not work and lead to an accident.
- To avoid damage to your transmission, do not try to accelerate with the shift lever in R (Reverse) or any forward gear position with the brake engaged.
- Do not use the engine brake (shifting from a high gear to lower gear) rap-

idly on slippery roads. The vehicle may slip causing an accident.

- Shifting into P (Park) whilst the vehicle is in motion will cause the drive wheels to lock which will cause you to lose control of the vehicle.
- When parking on an incline, block the wheels to prevent the vehicle from rolling down.
- For safety, always engage the parking brake with the gear in the P (Park) position except for the case of emergency parking.
- **DCT failure**
 - Do not use aggressive engine braking (shifting from a higher gear to a lower gear) on slippery roads. This could cause the tyres to slip and may result in an accident.
 - Do not shift into gear unless your foot is firmly on the brake pedal. Shifting into gear when the engine is running at high speed can cause the vehicle to move very rapidly. You could lose control of the vehicle and hit people or objects.
 - When stopped on a slope, do not hold the vehicle with accelerator pedal. Engage the service brake or the parking brake.
 - If the transmission cannot shift into Drive or Reverse, the position indicator (D or R) on the cluster will blink. We recommend that you contact an authorised Kia dealer/service partner to have the system checked.

CAUTION

- Always come to a complete stop before shifting into or out of R (Reverse); you may damage the

transmission if you shift into R (Reverse) whilst the vehicle is in motion, except as explained in "Rocking the vehicle" on page 6-47.

- Always park the vehicle in P (Park) for safety and engage the parking brake. If left in N (Neutral), the vehicle may move and cause serious damage and injury.
- After the vehicle has been turned off, the electronic parking brake cannot be disengaged.
- For EPB (Electronic Parking Brake) equipped vehicles with AUTO HOLD function used whilst driving, if the vehicle is in OFF position, the electronic parking brake will be engaged automatically. Therefore, AUTO HOLD function should be turned off before the vehicle is in OFF position.
- Do not shift from N (Neutral) or P (Park) into D (Drive), or R (Reverse) when the engine is above idle speed. The transmission may be damaged if you shift into P (Park) whilst the vehicle is in motion.

* NOTICE

Manual mode

• For shift lever type

- The driver must execute upshifts in accordance with road conditions, taking care to keep the engine speed below the red zone.
- Downshifts are made automatically when the vehicle slows down. When the vehicle stops, 1st gear is automatically selected.
- When the engine rpm approaches the red zone shift points are varied to upshift automatically.

- To maintain the required levels of vehicle performance and safety, the system may not execute certain gearshifts when the gear is operated.
 - When driving on a slippery road, shift into the 2nd gear which is better for smooth driving on a slippery road.
 - Always come to a complete stop before shifting into D (Drive) or R (Reverse).
 - Do not put the shift lever in N (Neutral) whilst driving.
 - The driver must execute upshifts in accordance with road conditions, taking care to keep the engine speed below the red zone.
 - Only the 7 forward gears can be selected. To reverse or park the vehicle, move the gear to the R (Reverse) or P (Park) position as required.
 - Downshifts are made automatically when the vehicle slows down. When the vehicle stops, 1st gear is automatically selected.
 - The fuel efficiency may decrease.
 - If the driver presses the lever to + (Up) or - (Down) position, the transmission may not make the requested gear change if the next gear is outside of the allowable engine rpm range.
- #### • For DCT type
- When manual mode is activated:
 - The engine rpm will tend to remain raised over a certain length of time even after releasing the accelerator.
 - Upshifts are delayed when accelerating.

Paddle shifter (if equipped)



Operation

1. Pull the right side (+) of the paddle shifter once to shift up.
2. Pull the left side (-) of the paddle shifter once to shift down.

Changing the shift mode

Automatic to Manual shift mode automatically

You can shift up/down with paddle shifter at Manual gate (lever type).

Operation

- For shift dial SBW type, pull paddle shifter once or more depending on the speed conditions.
- For shift lever type, push the shift lever from D (Drive) position into the manual gate.

Operating condition(s)

- The shift lever (or shift dial SBW) position should be in D (Drive) position.
- Paddle shifter doesn't work at low vehicle speed.

Manual to automatic shift mode

Operation

- Pull the right side (+) of paddle shifter once more than 1 second.
- Depress the accelerator pedal slightly more than 6 seconds on driving.
- Vehicle stop.

Operating condition(s)

- When the accelerator pedal is gently depressed for more than 6 seconds whilst driving.
- **For Manual Transmission and Automatic Transmission**
 - When the vehicle speed decreases below 7 km/h (4 mph).
- For DCT
 - When the vehicle speed decreases below 2km/h (1mph)

* NOTICE

If you pull the left and right side of the paddle shifters at the same time, you cannot shift the gear.

Brake system

In the event of brake failure

Operation

- Make an emergency stop with the parking brake.

Operating condition(s)

- The brake has failed

⚠ WARNING

Avoid applying the parking brake to stop the vehicle whilst it is moving except in an emergency situation. Applying the parking brake whilst the vehicle is moving at normal speeds can cause a sudden loss of control of the vehicle. If you must use the parking brake to stop the vehicle, use great caution in applying the brake.

Power-assisted brakes

Operation

- Apply greater force to the brake pedal.

Operating condition(s)

- The vehicle is stalled

*** NOTICE**

- When stepping on the brake pedal under a certain driving or weather condition, you may witness your car make a sound of squealing or some other noises. This is not a brake malfunction but a normal phenomenon.
- When driving on the road to which deicing chemicals are applied, the vehicle may witness noises from the brake or abnormal abrasion of tyres

because of such deicing chemicals. You should operate brake additionally so that you would be able to remove the deicing chemicals on the brake disk and pad under a safe traffic condition.

⚠ WARNING

Avoid continuous application of the brakes when descending a long or steep hill by shifting to a lower gear. Continuous brake application will cause the brakes to overheat and could result in a temporary loss of braking performance.

⚠ CAUTION

Do not drive with your foot resting on the brake pedal. This will create abnormally high brake temperatures which can cause excessive brake lining and pad wear.

Brake over accelerator

Operation

1. Apply the brakes steady and firmly.
2. Stop the vehicle safely.
3. Shift to P. Turn the engine off and apply the parking brake.
4. Inspect the accelerator pedal for any interference.

Operating condition(s)

- The accelerator pedal is stuck

*** NOTICE**

If none are found and the condition persists, have your vehicle towed to a professional workshop and inspected. Kia

recommends to visit an authorised Kia dealer/service partner.

Disc brake wear indicator

The front or rear brakes will squeal when the brake pads are worn. Always replace the front or rear brake pads as pairs.

⚠ WARNING

Do not ignore high pitched wear sounds from your brakes. If you ignore this audible warning, you will eventually lose braking performance, which could lead to a serious accident.

⚠ CAUTION

Do not continue to drive with worn brake pads. Continuing to drive with worn brake pads can damage the braking system and result in costly brake repairs.

* NOTICE

Brake dust may accumulate on the wheels, even under normal driving conditions. Some dust is inevitable as the brakes wear and contribute to brake noise.

Parking brake

Check if the brake warning light (ⓘ) appears when the vehicle is in the START or ON position. Be sure the parking brake is fully released and the brake warning light (ⓘ) is off before driving.

Parking brake (Hand type) (if equipped)

After parking the vehicle, apply the parking brake to prevent the vehicle from being moved by the external force.

Applying the parking brake



To engage the parking brake:

1. Apply the foot brake and then pull up the parking brake lever as far as possible.

In addition, it is recommended that when parking the vehicle on a incline, the shift lever should be in a low gear on manual transmission vehicles.

⚠ CAUTION

- Driving with the parking brake applied will cause excessive brake pad and brake rotor wear.
- Do not operate the parking brake whilst the vehicle is moving except in an emergency situation. It could damage the vehicle system and make endanger driving safety.

Releasing the parking brake



To release the parking brake:

1. Apply the foot brake and pull up the parking brake lever slightly.
2. Depress the release button (1) and lower the parking brake lever (2) whilst holding the button.

If the parking brake does not release or does not release all the way, have the system checked by a professional workshop. Kia recommends to visit an authorised Kia dealer/service partner.

- Be cautious when parking on a hill. Firmly engage the parking brake and place the shift lever in first or reverse gear (manual transmission). If your vehicle is facing downhill, turn the front wheels into the kerb to help keep the vehicle from rolling. If your vehicle is facing uphill, turn the front wheels away from the kerb to help keep the vehicle from rolling. If there is no kerb or if it is required by other conditions to keep the vehicle from rolling, block the wheels.
- Under some conditions your parking brake can freeze in the engaged position. This is most likely to happen when there is an accumulation of snow or ice around or near the rear brakes or if the brakes are wet. If there is a risk that the parking brake may freeze, apply it only temporarily whilst you put the shift lever in first or reverse gear (manual transmission) and block the rear wheels so the vehicle cannot roll. Then release the parking brake.
- Do not hold the vehicle on the upgrade with the accelerator pedal. This can cause the transmission to overheat. Always use the brake pedal or parking brake.

WARNING

- Never allow a passenger to touch the parking brake. If the parking brake is released unintentionally, serious injury may occur.
- All vehicles should always have the parking brake fully engaged when parking to avoid inadvertent movement of the vehicle which can injure occupants or pedestrians.



Check the brake warning light by turning the ignition switch ON (do not start the engine). This light will be appeared when the parking brake is applied with the ignition switch in the START or ON position.

Before driving, be sure the parking brake is fully released and the brake warning light is off.

If the brake warning light remains on after the parking brake is released whilst engine is running, there may be a malfunction in the brake system. Immediate attention is necessary.

If at all possible, cease driving the vehicle immediately. If that is not possible, use extreme caution whilst operating the vehicle and only continue to drive the vehicle until you can reach a safe location or repair shop.

Parking brake (Foot type) (if equipped)



Operation

1. Depress the parking brake pedal down as far as possible to apply the parking brake.
2. Depress the parking brake pedal again to release the parking brake.

⚠ WARNING

- To reduce the risk of **SERIOUS INJURY** or **DEATH**, do not operate the parking brake whilst the vehicle is moving except in an emergency situation. It could damage the brake system and lead to an accident.
- Whenever leaving the vehicle or parking, always come to a complete stop and continue to depress the brake pedal. Make sure the gear is shifted to P (Park) position, then apply the parking brake, and place the ignition switch in the LOCK/OFF position. Vehicles with the parking brake not fully engaged are at risk for moving inadvertently and causing injury to yourself or others.
- **NEVER** allow anyone who is unfamiliar with the vehicle to touch the parking brake. If the parking brake is released unintentionally, serious injury may occur.
- Only release the parking brake when you are seated inside the vehicle with your foot firmly on the brake pedal.

- Never allow a passenger to touch the parking brake. If the parking brake is released unintentionally, serious injury may occur.

*** NOTICE**

- Do not apply the accelerator pedal whilst the parking brake is engaged. If you depress the accelerator pedal with the parking brake engaged, warning will sound. Damage to the parking brake may occur.
- Driving with the parking brake on can overheat the braking system and cause premature wear or damage to brake parts. Make sure the parking brake is released and the brake warning light is off before driving.

Electronic Parking Brake (EPB) (if equipped)

Applying and releasing EPB manually

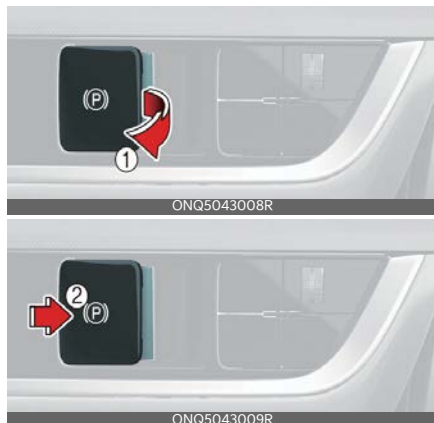

Operation

- Application

- Depress the brake pedal and pull the EPB switch up(1) to apply the parking brake.
- Release
 - Depress the brake pedal. Make sure the gear is in P and push the EPB switch(2) down to release the parking brake.

⚠ WARNING

- Risk of accident and injury due to children left unattended in the vehicle. If you leave children unaccompanied in the vehicle, they may be able to set the vehicle in motion, for example by:
 - Releasing the parking brake.
 - Shifting the transmission out of P (Park) position.
 - Starting the engine. In addition, they may operate vehicle equipment.
- Never leave children and animals unattended in the vehicle.
- When leaving the vehicle, always take the smart key with you and lock the vehicle.

*** NOTICE**

- On a steep incline or when pulling a trailer, if the vehicle does not remain at a standstill, do as follows:
 - Apply the EPB.
 - Pull up the EPB switch for more than 3 seconds.
- A click or electric brake motor whine sound may be heard whilst operating or releasing the EPB. These conditions are normal and indicate that the EPB is functioning properly.

Applying EPB automatically

Operating condition(s)

- Shifting to P on a slope for shift dial SBW type
- Vehicle is in OFF position whilst AUTO HOLD is enabled
- When the vehicle moves a bit in P for shift dial SBW type
- Requested by other systems
- Conditions below whilst AUTO HOLD is activated:
 - Driver's door is opened
 - Bonnet is opened
 - Tailgate is opened
 - Vehicle stops for more than approximately 10 minutes
 - Vehicle stops on a steep slope
 - Requested by other systems

*** NOTICE**

For Electronic Parking Brake (EPB) equipped vehicles with AUTO HOLD function used whilst driving, if the ENGINE START/STOP button has been turned OFF, the EPB will be engaged automatically. Therefore, AUTO HOLD function should be turned off before the ENGINE START/STOP button is turned off.

Releasing EPB automatically

Operation

1. Start the vehicle.
2. Fasten the driver's seat belt.
3. Close the driver's door, bonnet and tailgate.
4. When the vehicle is ON, depress the brake pedal and shift to R or D.

- Depress the accelerator pedal whilst the gear is in R, D or manual mode.

⚠ CAUTION

Do not drive your vehicle with the EPB applied. It may cause excessive brake pad and brake rotor wear.

* NOTICE

- Do not follow these procedures when driving on a flat level ground. The vehicle may suddenly move forward:
 - For your safety, depress the brake pedal and release the parking brake manually with the EPB switch when you drive downhill or when backing up the vehicle.
 - For your safety, you can engage the EPB even though the vehicle is in the OFF position, but you cannot release it.
- If the parking brake warning light is still on even though the EPB has been released, have the system checked by a professional workshop. Kia recommends to visit an authorised Kia dealer/service partner.

EPB warning message

Operating condition(s)

- Attempting to drive off whilst engaging the accelerator pedal with the EPB applied
 - Driver's seat belt is not fastened and the vehicle bonnet, driver's door or tailgate is opened
 - There is a problem with the vehicle
 - Conversion from AUTO HOLD to EPB is not working properly
- EPB is applied whilst AUTO HOLD is activated due to Electronic Stability Control (ESC) signal

EPB malfunction indicator

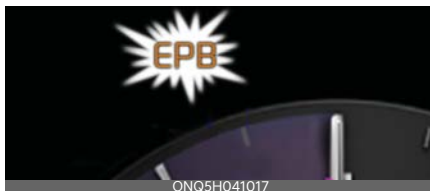

If the EPB malfunction indicator remains on, appears whilst driving, or does not appear when the vehicle is in the ON position, this indicates the EPB may malfunction.

Have your vehicle checked by a professional workshop as soon as possible. Kia recommends to visit an authorised Kia dealer/ service partner.

* NOTICE

- The EPB warning light may appear if the EPB switch operates abnormally. Shut the engine off and turn it on again after a few minutes. The warning light will go off and the EPB switch will operate normally. However, if the EPB warning light is still on, have the system checked by a professional workshop. Kia recommends to visit an authorised Kia dealer/ service partner.
- If the parking brake warning light does not appear or blinks even though the EPB switch was pulled up, the EPB is not applied.
- If the parking brake warning light blinks when the EPB warning light is on, press the EPB switch, then pull it up. Once more press it back to its original position and pull it back up. If the EPB warning does not go off, have the system checked by a professional

workshop. Kia recommends to visit an authorised Kia dealer/ service partner.

Emergency braking with the EPB switch

Pull and hold the EPB switch up to engage the emergency brake.

⚠ WARNING

Do not operate the Electronic Parking Brake (EPB) whilst the vehicle is moving except in an emergency situation. Applying the EPB whilst the vehicle is moving at normal speeds can cause a sudden loss of control of the vehicle. If you must use the EPB to stop the vehicle, use great caution in applying the brake.

* NOTICE

During emergency braking by the EPB, the parking brake warning light will appear to indicate that the system is operating.

When the EPB does not release properly

Load the vehicle on a flatbed tow truck and take your vehicle to a professional workshop to check the system. Kia recommends to visit an authorised Kia dealer/service partner.

AUTO HOLD (if equipped)

The AUTO HOLD maintains the vehicle in a stopped position without depressing the brake pedal.

Applying AUTO HOLD

Operation

1. Press the AUTO HOLD button. The AUTO HOLD indicator will illuminate white.
2. The AUTO HOLD indicator changes from white to green when the vehicle is stopped.

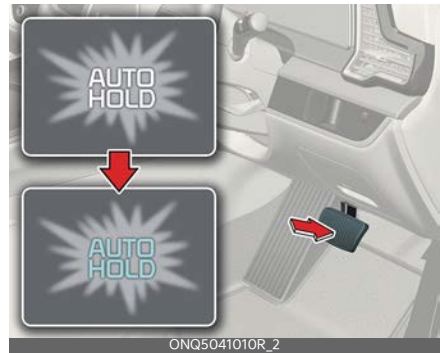

3. AUTO HOLD will be released automatically when the accelerator pedal is depressed in D, R or in the manual mode. the AUTO HOLD indicator changes from green to white.
4. Press the AUTO HOLD button again whilst depressing the brake pedal to cancel the AUTO HOLD operation.



Non-operating condition(s)

- The gear is in P (Park)
- The EPB is applied

* INFORMATION

If the vehicle is restarted with the AUTO HOLD button pressed, AUTO HOLD will be in the standby state.

⚠ WARNING

- To reduce the risk of an accident, do not activate AUTO HOLD whilst driving downhill, backing up or parking your vehicle.
- For shift lever type, AUTO HOLD will not be activated when the gear is in R (Reverse).

* NOTICE

- If the AUTO HOLD indicator lights up yellow, the AUTO HOLD is not working properly. Take your vehicle to a professional workshop and have the system checked. Kia recommends to visit an authorised Kia dealer/service partner.
- A click or electric brake motor whine sound may be heard whilst operating or releasing the EPB, but these conditions are normal and indicate that the EPB is functioning properly.

AUTO HOLD warning messages

The AUTO HOLD function will display a warning message with sound under certain conditions:

- When the EPB is automatically applied from AUTO HOLD
- AUTO HOLD to EPB conversion is not working properly
- Brake pedal is not applied when the AUTO HOLD button is pressed

Vehicle safety system

Anti-lock Brake System (ABS)

The Anti-lock Brake System (ABS) prevents the wheels from locking to steer and stabilize the vehicle.

If the ABS warning light (ABS) stays on, contact a professional workshop as soon as possible. Kia recommends to visit an authorised Kia dealer/service partner.

* NOTICE

- A click sound may be heard in the vehicle compartment when the vehicle begins to move after the vehicle is started. These conditions are normal and indicate that the Anti-lock Brake System is functioning properly.
- When you jump start your vehicle because of a drained battery, the vehicle may not run as smoothly and the ABS warning light may turn on at the same time. This happens because of low battery voltage. It does not mean your ABS has malfunctioned.
 - Do not pump your brakes!
 - Have the battery recharged before driving the vehicle.

Electronic Stability Control (ESC) (if equipped)

Electronic Stability Control (ESC) is designed to stabilize the vehicle during cornering manoeuvres.

ESC is not a substitute for safe driving practices. Factors including speed, road conditions and driver steering input can all affect whether ESC will be effective in preventing a loss of control.

Operating ESC OFF button



Operation

1. Press the ESC OFF button for approximately half a second to turn ESC off. ESC OFF (OFF) indicator light will appear and the warning chime will sound.
2. Press and hold the ESC OFF button again for approximately 3 second to turn ESC and traction control off. ESC OFF (OFF) indicator light will appear and the warning chime will sound.
3. To turn ESC on again, press the ESC OFF button. ESC OFF (OFF) indicator light will go off.

⚠ WARNING

- For maximum protection, always wear your seat belt. No system, no matter how advanced, can compensate for all driver error and/or driving conditions. Always drive responsibly.
- Drive carefully even though your vehicle has Electronic Stability Control. It can only assist you in maintaining control under certain circumstances.
- Never press the ESC OFF button whilst ESC is operating (ESC indicator light blinks). If ESC is turned off whilst ESC is operating, the vehicle may slip out of control.

* NOTICE

- A click sound may be heard in the vehicle compartment when the vehicle begins to move after the vehicle is

started. These conditions are normal and indicate that the Electronic Stability Control system is functioning properly.

- When operating the vehicle on a dynamometer, ensure that the ESC is turned off (ESC OFF light appeared). If the ESC is left on, it may prevent the vehicle speed from increasing, and result in false diagnosis.
- Turning the ESC off does not affect ABS or brake system operation.

Downhill Brake Control (DBC) (if equipped)

Downhill Brake Control (DBC) feature assists the driver to descend down a steep hill without having to depress the brake pedal.



Always turn DBC off on normal roads. It might activate inadvertently from the standby mode when driving through speed bumps or making sharp turns.

Operating DBC



Operation

| Mode | Indicator light | Conditions |
|---------|--|--|
| Standby | appeared  | Press the DBC button when the vehicle speed is under 60 km/h (40 mph). |

| Mode | Indicator light | Conditions |
|-------------------------|--|---|
| Activated | Blinks  | <ul style="list-style-type: none"> • The vehicle is in a certain angle of inclination • The accelerator pedal is not depressed. • The vehicle speed is within 4~40 km/h (2.5~25 mph) • Within the activation speed range 4~40 km/h (2~25 mph), the driver can control the vehicle speed by depressing the brake pedal or accelerator pedal. |
| Temporarily deactivated | appeared  | <ul style="list-style-type: none"> • The vehicle is not in a certain angle of inclination • The accelerator pedal is depressed. • The vehicle speed is in the range of 40~60 km/h (25~40 mph) |
| OFF | Not appeared  | <ul style="list-style-type: none"> • The DBC button is pressed again. • When the accelerator pedal is depressed and the vehicle speed is over 60 km/h (40 mph) |

Non-operating condition(s)

- The gear is in P (Park).
- The ESC is activated.

* INFORMATION

Whilst the DBC is activated, the vehicle speed can be controlled by depressing an accelerator pedal or a brake pedal.

⚠ WARNING

If the DBC yellow indicator light appears, the system may have overheated or have malfunctioned. When the warning light appears even though the DBC system has cooled off, have your vehicle checked by an authorised Kia dealer as soon as possible.

* NOTICE

- The DBC may not deactivate on steep inclines even though the brake or accelerator pedal is depressed.
- The DBC defaults to the OFF position whenever the ignition switch is placed in the ON position.
- Noise or vibration may occur from the brakes when the DBC is activated.
- The rear stop light comes on when DBC is activated.

Hill-start Assist Control (HAC) (if equipped)

Hill-start Assist Control (HAC) prevents the vehicle from rolling back by applying the brakes automatically for approximately 2 seconds.

The brakes are released when the accelerator pedal is engaged or after approximately 2 seconds.

⚠ WARNING

HAC does not replace the need to apply brakes whilst stopped on an incline. Whilst stopped, make sure you maintain brake pressure sufficient to prevent your vehicle from rolling backward and causing an accident. Don't release the brake pedal until you are ready to accelerate forward.

Multi-Collision Brake (MCB) (if equipped)

Multi-Collision Brake controls the brake automatically in the event of an accident where the air bag deploys to reduce the risk of additional accidents that may occur.

System operation

- From the time the air bag deploys, Multi-Collision Brake monitors the depression intensity of the brake pedal and accelerator pedal for a short period. The system operates when the following conditions are met:
 - Vehicle speed is under 180 km/h (112 mph) at the time of collision.
 - The brake pedal and accelerator pedal are pressed only slightly .
- When the driver steps on the brake pedal over a certain level whilst Multi-Collision Brake is active, the braking power takes priority over automatic braking by Multi-Collision Brake system. However, if the driver takes his/her foot off the brake pedal, Multi-Collision Brake system will maintain automatic braking.

System off

- Multi-Collision Brake is cancelled in the following situations:
 - The accelerator pedal is depressed over a certain level.
 - The vehicle stops.
 - ESC (Electronic Stability Control) or electronic devices has malfunctioned.
 - In a situation system cannot operate normally.
 - Ten seconds have passed since the brake has been controlled automatically by Multi-Collision Brake system.

⚠ WARNING

- Multi-Collision Brake decreases vehicle speed after a collision and reduces the risk of a second collision, but it

does not prevent a second collision. You may drive away from the collision spot to avoid other dangerous situations by depressing the accelerator pedal.

- After the vehicle is stopped by Multi Collision Brake, the system stops controlling the brakes.

Depending on the situation, the driver should depress the brake or the accelerator pedal to prevent a further accident.

Vehicle Stability Management (VSM) (if equipped)

Vehicle Stability Management (VSM) provides further enhancements to vehicle stability and steering responses.

Operating VSM

Operation

1. Press the ESC OFF button to turn VSM off and the ESC OFF indicator light (ESC OFF) is appeared.
2. Press the ESC OFF button again to turn VSM on and the ESC OFF indicator light (ESC OFF) will go off.

Operating condition(s)

- Driving on a slippery road
- Friction change of left and right wheels is detected

Non-operating condition(s)

- Driving on a gradient or inclined surface
- Driving in reverse
- ESC OFF indicator light (ESC OFF) remains appeared

- EPS warning light (EPS) remains appeared

WARNING

When replacing tyres and wheels, make sure they are the same size as the original tyres and wheels installed. Driving with varying tyre or wheel sizes may diminish any supplemental safety benefits of the VSM system.

VSM malfunction indicator

VSM can be deactivated when the malfunction has been detected in the Electronic Power Steering system or VSM system. If the ESC indicator light (ESC) or EPS warning light (EPS) remains on, take your vehicle to a professional workshop and have the system checked. Kia recommends to visit an authorised Kia dealer/service partner.

Emergency Stop Signal (ESS) (if equipped)

Emergency Stop Signal (ESS) alerts the driver behind by blinking the brake lights whilst braking sharply and severely.

Operating condition(s)

- The vehicle suddenly stops.
- ABS is activated and the driving speed is over 55 km/h (34 mph).
- The hazard warning flasher automatically turns ON after blinking the brake lights when:
 - The driving speed is under 40 km/h (25 mph),
 - The ABS is deactivated
 - The sudden braking is over
- The hazard warning flasher turns OFF when:

- The vehicle drives at a low speed for a certain period of time.

* NOTICE

The Emergency Stop Signal (ESS) system will not activate, when the hazard warning flashers are already on.

Trailer Stability Assist (TSA) (if equipped)

Trailer Stability Assist (TSA) is operated as a vehicle stability control system. TSA is designed to stabilize the vehicle and trailer when the trailer sways or oscillates.

Brake Assistant System (BAS) (if equipped)

The Brake Assistant System provides additional pressure when the brake pedal is momentarily and strongly depressed in a situation sudden braking is required whilst driving.

The Brake Assistant System reduces the time for ABS(Anti-Lock Brake System) control to enter and consequently reduces the braking distance, by providing additional pressure up to the point of ABS intervention.

BAS operation

- When the vehicle speed is more than 30 km/h (20 mph) and the ABS control is not entered.
- When the brake pedal is depressed strongly over a certain level.
- When the friction of the road surface is above a certain level.

BAS operation off

- The vehicle speed is below 10 km/h (6 mph).

- The brake pedal is depressed over a certain conditions.
- The friction of the road surface is below a certain level.

⚠ WARNING

The system may not operate depending on driver's driving habit, the degree to which the brake pedal is depressed and the road surface condition.

Drive mode integrated control system

DRIVE MODE

Selecting DRIVE MODE



Operation

- Turn the DRIVE MODE knob.

| Mode | Characteristics | SCC Responsiveness |
|--------|---|--------------------|
| ECO | Improves fuel efficiency for eco-friendly driving | Slow |
| NORMAL | Provides smooth driving and comfortable riding | Normal |
| SPORT | Provides sporty and firm riding | Fast |
| SMART | Selects the proper driving mode by driving habits | Normal |

* INFORMATION

- ECO/NORMAL/SMART mode will be maintained when the vehicle is restarted.
- SPORT MODE will change to NORMAL mode when the vehicle is restarted.

* NOTICE

If there is a problem with the instrument cluster, the drive mode will be in NORMAL mode and may not change to ECO mode or SPORT mode.

ECO mode

- The engine and transmission control logic are changed to maximize fuel efficiency.

- The ECO indicator will appear.
- Whenever the engine is restarted, the drive mode remains in ECO mode.

* NOTICE

Fuel efficiency depends on the driver's driving habit and road condition.

NORMAL mode

- NORMAL mode provides smooth driving and comfortable riding.

SPORT mode

- The steering effort, the engine and transmission control logic is automatically adjusted for enhanced driver performance.
- The SPORT indicator will appear.
- Whenever the engine is restarted, the drive mode sets to NORMAL mode.
- The engine rpm will tend to remain raised over a certain length of time even after releasing the accelerator.
- Upshifts are delayed when accelerating.

* NOTICE

The fuel efficiency may decrease in SPORT mode.

SMART mode

- The proper driving mode is selected among ECO, NORMAL, and SPORT by judging the driver's driving habits.
- Gear shifting patterns and engine torque is automatically controlled in accordance with the driver's driving habits.
- The SMART indicator will appear.
- Whenever the engine is restarted, the drive mode sets to SMART mode.

Characteristics of SMART mode

- The driving mode automatically changes to ECO mode after a certain period of time, when you gently depress the accelerator pedal.
- The driving mode automatically changes from SMART ECO mode to SMART NORMAL mode after a certain period of time, when the driver sharply or repetitively depresses the accelerator pedal.
- The driving mode automatically changes to SMART NORMAL mode with the same driving patterns, when the vehicle starts to drive on an upward slope of a certain angle. The driving mode automatically returns to SMART ECO mode, when the vehicle enters a leveled road.
- The driving mode automatically changes to SMART SPORT mode when you abruptly accelerate the vehicle or repetitively operate the steering wheel. In this mode, your vehicle drives in a lower gear for abrupt accelerating/decelerating and increases the engine brake performance.
- You may still sense the engine braking performance, even when you release the accelerator pedal in SMART SPORT mode. It is because your vehicle remains in lower gear over a certain period of time for next acceleration. Thus, it is a normal driving situation, not indicating any malfunction.
- The driving mode automatically changes to SMART SPORT mode only in harsh driving situations. In most of the normal driving situations, the driving mode sets to be either in SMART

ECO mode or in SMART NORMAL mode.

Limitations of SMART mode

The SMART mode may be limited in following situations.

- Cruise Control may deactivate the SMART mode when the vehicle is controlled by the set speed of Smart Cruise Control. (SMART mode is not deactivated just by activating Cruise Control.)
- The SMART mode can be activated in most of the normal driving situations. However, an extremely high/low transmission oil temperature may temporarily deactivate the SMART mode, because the transmission condition is out of normal operation condition.

* NOTICE

- When you mildly drive the vehicle in SMART mode, the driving mode changes to ECO mode to improve fuel efficiency. However, the actual fuel efficiency may differ in accordance with your driving situations (i.e. upward/downward slope, vehicle deceleration/acceleration).
- When you dynamically drive the vehicle in SMART mode by abruptly decelerating or sharply turning, the driving mode changes to SPORT mode. However, it may adversely affect fuel economy.

All Wheel Drive (AWD) system (if equipped)

The All Wheel Drive (AWD) system delivers engine power to front and rear wheels for maximum traction.

AWD is useful when extra traction is required, such as when driving slippery, muddy, wet, or snow-covered roads.

If the system determines there is a need for four-wheel drive, the engine's driving power will be distributed to all four wheels automatically.

Terrain Mode (if equipped)

Selecting Terrain Mode



Operation

1. Press DRIVE/TERRAIN mode button.
2. Turn the knob to select Terrain Mode.
3. The selected Terrain Mode will appear on the instrument cluster.
4. Press DRIVE/TERRAIN mode button again to return to Drive Mode.

| Mode | Characteristics |
|------|---|
| SNOW | Appropriately distributes the vehicle's traction forces and prevents wheel slippage when driving on snowy or slippery road. |
| MUD | Appropriately distributes the vehicle's traction forces when driving on muddy, unpaved or rough roads. |
| SAND | Appropriately distributes the vehicle's traction forces when driving on sandy, gravelled or unpaved roads. |

* NOTICE

Even though you turned off the vehicle in Terrain Mode, Drive Mode will be set when you restart the vehicle.

4WD Lock Mode (if equipped)

The main goal of AWD Lock mode is to allow a driver to maximize the vehicle's traction under extreme driving conditions such as unpaved off-road, sandy roads, and muddy roads.

Selecting 4WD Lock Mode



Operation

1. Press 4WD Lock Mode button. The 4WD Lock indicator light (LOCK) will appear on the instrument cluster.
2. Press 4WD Lock Mode button again to turn off 4WD Lock Mode. The 4WD Lock indicator light (LOCK) will turn off.

Brake lock on tight corners

This is a unique characteristic of a 4WD vehicle when making a slow rotation in 4WD Lock Mode. The driver will feel like the brake is applied due to the difference in tyre rotation. Steering may be more difficult in a sharp turn on the paved road in 4WD Lock Mode.

⚠ WARNING

Do not make a fast, sharp turns when 4WD Lock Mode is ON. The steering may be difficult and the accident may happen.

Advantages of 4WD

- Enhance safety when driving straight.
- Improve performance when cornering.
- Ensure operability in tough driving conditions such as snow, rain, sand, etc.

⚠ WARNING

- This vehicle is designed primarily for on road use although it can operate effectively off road. However, it was not designed to drive in challenging off-road conditions. Driving in conditions that exceed the vehicle's intended design or the driver's experience level may result in severe injury or death.
- If the AWD warning light (⚠) stays on the instrument cluster, your vehicle may have a malfunction with the AWD system. Have your vehicle checked by a professional workshop. Kia recommends to visit an authorised Kia dealer/service partner.
- To reduce the risk of **SERIOUS INJURY** or **DEATH**:
 - Do not drive in conditions that exceed the vehicle's intended design such as challenging off-road conditions.
 - Avoid high speeds when cornering or turning.
 - Do not make quick steering wheel movements, such as sharp lane changes or fast, sharp turns.
 - The risk of a rollover is greatly increased if you lose control of your vehicle at highway speeds.
 - Loss of control often occurs if two or more wheels drop off the roadway and the driver over steers to reenter the roadway.

- In the event your vehicle leaves the roadway, do not steer sharply. Instead, slow down before pulling back into the travel lanes.

⚠ CAUTION

- Maintain Drive Mode when driving on roads in normal conditions.
- Driving in Terrain Mode/4WD Lock Mode on normal roads may damage the 4WD system and cause mechanical vibration or noise.
- When driving under normal road conditions (especially when cornering) in Terrain Mode/4WD Lock Mode, a driver may find minor mechanical vibration or noise, which is extremely normal phenomenon, not a malfunction. When Terrain Mode/4WD Lock Mode is released, such noise or vibration will be immediately gone.
- When you turn off Terrain Mode/4WD Lock Mode, it can lead to little shocks but this is a normal phenomenon that lasts until the traction forces on the front and rear wheels of the vehicle are released.

For safe 4WD operation

- Do not try to drive in deep standing water or mud since such conditions can stall your engine and clog your exhaust pipes.
- Do not drive down steep hills since it requires extreme skill to maintain control of the vehicle.
- When you are driving up or downhill, drive as straight as possible. Use extreme caution in going up or down steep hills, since you may flip your vehicle over depending on the grade, terrain and water/mud conditions.

- You must learn how to corner in a 4WD vehicle. Do not rely on your experience in conventional FWD/RWD vehicles when cornering the vehicle in 4WD mode. For starters, you must drive slower in 4WD.
- Always hold the steering wheel firmly when you are driving on unpaved roads.
- Make sure all passengers are wearing seat belts.

WARNING

- The conditions of on-road or off-road that demand All Wheel Drive mean all functions of your vehicle are exposed to extreme stress than under normal road conditions. Slow down and be ready for changes in the composition and traction of the surface under your tyres. If you have any doubt about the safety of the conditions you are facing, stop and consider the best way to proceed.
- Driving across the contour of steep hills can be extremely dangerous. This danger can come from slight changes in the wheel angle which can destabilize the vehicle or, even if the vehicle is maintaining stability under power, it can lose that stability if the vehicle stops its forward motion. Your vehicle may roll over without warning and without time for you to correct a mistake that could cause serious injury or death.
- Reduce speed when you turn corners. The centre of gravity of AWD vehicles is higher than that of conventional FWD/RWD vehicles, making them more likely to roll over when you turn corners too fast.
- Do not grab the inside of the steering wheel when you are driving on unpaved roads. You may hurt your arm by a sudden steering manoeuvre or from steering wheel rebound due to impact with objects on the ground. You could lose control of the steering wheel.
- If you are driving in heavy wind, the vehicle's higher centre of gravity decreases your steering control capacity and requires you to drive more slowly.
- Drive slowly. If you are driving too fast in water, the water can get into the engine compartment and wet the ignition system, causing your vehicle to suddenly stop. If this happens and your vehicle is in a tilted position, your vehicle may roll over.
- Avoid high cornering speed.
- Do not make quick steering wheel movements, such as sharp lane changes or fast, sharp turns.
- The risk of rollover is greatly increased if you lose control of your vehicle at high speed.
- In a collision, an unbelted person is significantly more likely to die compared to a person wearing a seat belt.
- Loss of control often occurs if two or more wheels drop off the roadway and the driver over-steers to re-enter the roadway. In the event your vehicle leaves the roadway, do not steer sharply. Instead, slow down before pulling back into the travel lanes.

CAUTION

If one of the front or rear wheels begins to spin in mud, snow, etc. the vehicle can sometimes be driven out by engaging the accelerator pedal further; however avoid running the engine continuously

at high rpm because doing so could damage the AWD system.

* NOTICE

- Do not drive in water if the level is higher than the bottom of the vehicle.
- Check your brake condition once you are out of mud or water. Press the brake pedal several times as you move slowly until you feel normal braking forces return.
- Shorten your scheduled maintenance interval if you drive in off-road conditions such as sand, mud or water, refer to "Scheduled maintenance service" on page 9-9. Always wash your vehicle thoroughly after off-road use, especially cleaning the bottom of the vehicle.
- Since the driving torque is always applied to the 4 wheels the performance of the 4WD vehicle is greatly affected by the condition of the tyres. Be sure to equip the vehicle with four tyres of the same size and type.
- A full time 4WD vehicle cannot be towed by an ordinary tow truck. Make sure that the vehicle is placed on a flat bed truck for moving.

Driving in sand or mud

- Maintain slow and constant speed. Operate the accelerator pedal slowly to ensure safe driving (wheel-slip prevention).
- Keep sufficient distance between your vehicle and the vehicle in front of you.
- Reduce vehicle speed and always check the road condition.
- Avoid speeding, rapid acceleration, sudden brake applications, and sharp turns to prevent getting stuck.

- When the vehicle is stuck in snow, sand or mud, the tyres may not operate. This is to protect the transmission and not a malfunction.

Emergency precautions

Tyres

- Equip all 4 tyres with the same size, type, tread, brand and load-carrying capacity.
- Do not install tyres and wheels with different size and type from the one originally installed on your vehicle.
- Replace the front and rear tyre positions every 10,000 km (6,000 miles).
- Check each tyre monthly during cold weather. Inflate the tyres to recommended inflation pressure. Refer to "Tyres and wheels" on page 10-6.
- Install the chains on the front wheels. Keep the travel distance as short as possible, as this may damage the AWD system. Refer to "Tyre chains" on page 6-50.

Towing

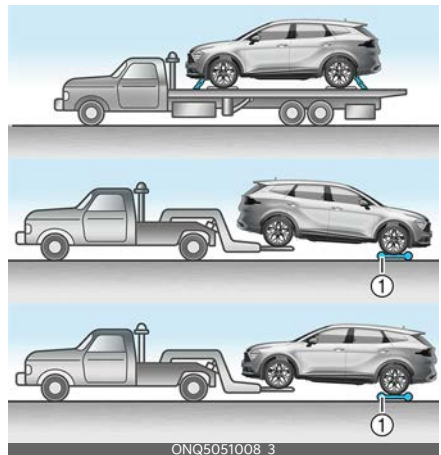

The 4WD vehicle should never be towed with the wheels on the ground. Your

vehicle must be towed with a flatbed equipment with all the wheels off the ground or wheel lift and dollies (1).

For more information, refer to "Trailer towing (if equipped)" on page 6-53.

⚠ WARNING

- Your vehicle is equipped with tyres designed to provide safe ride and handling capability. Do not use tyres and wheels that are different in size and type from the originally installed ones. It can affect the safety and performance of your vehicle, which could lead to steering failure or rollover and serious injury. When replacing the tyres, be sure to equip all four tyres with the tyre and wheel of the same size, type, tread, brand and load-carrying capacity.
- Whilst the full-time 4WD vehicle is being raised on a jack, never start the engine or cause the tyres to rotate. There is the danger that rotating tyres touching the ground could cause the vehicle to go off the jack and to jump forward.

⚠ CAUTION

- The AWD vehicle cannot be towed with sling-type equipment. Use wheel lift or flatbed equipment.
- When lifting up the vehicle, do not operate front and rear wheel separately. All four wheels should be operated.
- If you need to operate the front wheel and rear wheel when lifting up the vehicle, you should release the parking brake.

Dynamometer testing

A 4WD vehicles must be tested on a special 4 wheel chassis dynamometer.

If a 2WD roll tester must be used, perform the following procedure.

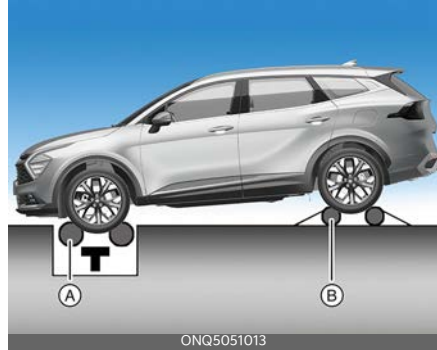

A: Roll tester (Speedometer)

B: Temporary free roller

Operation

1. Check the recommended tyre pressure for your vehicle.
2. Place the front wheels on the roll tester (A) for a speedometer test as shown in the illustration.
3. Release the parking brake.
4. Place the rear wheels on the temporary free roller as shown in the illustration.

⚠ WARNING

- Do not use tyre and wheel with different size and type from the one originally installed on your vehicle. It can affect the safety and performance of your vehicle, which could lead to steering failure or rollover causing serious injury.
- Never start or run the vehicle whilst a 4WD vehicle is raised on a jack. The vehicle can slip or roll off of a jack

causing serious injury or death to you or those nearby.

- Keep away from the front of the vehicle whilst the vehicle is in gear on the dynamometer. This is very dangerous as the vehicle can jump forward and cause serious injury or death.

* NOTICE

Never engage the parking brake whilst performing these tests.

Economical operation

Your vehicle's fuel economy depends mainly on your style of driving, where you drive and when you drive.

Each of these factors affects how many kilometres (miles) you can get from a litre (gallon) of fuel. To operate your vehicle as economically as possible, use the following driving suggestions to help save money in both fuel and repairs:

- Drive smoothly.
- Drive at a moderate speed.
- Take care of your tyres.
- Be sure that the wheels are aligned correctly.
- Maintain your vehicle in accordance with the maintenance schedule.
- Don't carry unnecessary weight in your vehicle.
- Don't let the engine idle longer than necessary.
- Don't "lug" or "over-rev" the engine.
- Don't open the windows at high speeds.
- Slow down when driving in crosswinds and headwinds.

⚠ WARNING

Never turn the engine off to coast down hills or anytime the vehicle is in motion. The power steering and power brakes will not function properly without the engine running. In addition, turning off the ignition whilst driving could engage the steering wheel lock resulting in loss of vehicle steering. Keep the engine on and downshift to an appropriate gear for engine braking effect.

Special driving conditions

If driving conditions deteriorate due to poor weather or road conditions, you should pay even more attention than usual.

Hazardous driving conditions

When hazardous driving conditions are encountered such as water, snow, ice, mud, sand, or similar hazards, follow these suggestions:

- Drive cautiously and allow extra distance for braking.
- Avoid sudden braking or steering.
- Do not pump the brake pedal on a vehicle equipped with ABS.
- If stalled in snow, mud, or sand, use the second gear. Accelerate slowly to avoid spinning the drive wheels.
- Use sand, rock salt, or other nonslip material under the drive wheels to provide traction when stalled in ice, snow, or mud.

Reducing the risk of a rollover

This multi-purpose passenger vehicle is defined as a Sports Utility Vehicle (SUV). Utility vehicles have a significantly higher rollover rate than other types of vehicles. SUVs have higher ground clearance and a narrower track to make them capable of performing in a wide variety of offroad applications.

Specific design characteristics give them a higher centre of gravity than ordinary vehicles. An advantage of the higher ground clearance is a better view of the road, which allows you to anticipate problems.

They are not designed for cornering at the same speeds as conventional passenger vehicles, any more than low-

slung sports vehicles are designed to perform satisfactorily in off-road conditions. Due to this risk, driver and passengers are strongly recommended to buckle their seat belts.

In a rollover crash, an unbelted person is significantly more likely to die than a person wearing a seat belt. There are steps that a driver can make to reduce the risk of a rollover.

If at all possible, avoid sharp turns or abrupt manoeuvres, do not load your roof rack with heavy cargo, and never modify your vehicle in any way.

WARNING

- Your vehicle is equipped with tyres designed to provide safe ride and handling capability. Do not use tyres and wheels that are different in size and type from the originally installed ones. It can affect the safety and performance of your vehicle, which could lead to steering failure or rollover and serious injury. When replacing the tyres, be sure to equip all four tyres with the tyre and wheel of the same size, type, tread, brand and load-carrying capacity.
- As with other Sports Utility Vehicle (SUV), failure to operate this vehicle correctly may result in loss of control, an accident or vehicle rollover.
 - Utility vehicles have a significantly higher rollover rate than other types of vehicles.
 - Specific design characteristics (higher ground clearance, narrower track, etc.) give this vehicle a higher centre of gravity than ordinary vehicles.
 - A SUV is not designed for cornering at the same speeds as conventional vehicles.

- Avoid sharp turns and abrupt manoeuvres.
- In a rollover crash, an unbelted person is significantly more likely to die than a person wearing a seat belt. Make sure everyone in the vehicle is properly buckled up.

Rocking the vehicle

If it is necessary to rock the vehicle to free it from snow, sand, or mud, first turn the steering wheel right and left to clear the area around your front wheels. Then, shift back and forth between R (Reverse) and any forward gear.

Do not race the engine, and spin the wheels as little as possible. If you are still stuck after a few tries, have the vehicle pulled out by a tow vehicle to avoid engine overheating and possible damage to the transmission.

WARNING

Do not attempt to rock the vehicle if people or objects are nearby. The vehicle may suddenly move forward or backwards as it becomes unstuck.

CAUTION

- Prolonged rocking may cause vehicle overheating, transmission damage or failure, and tyre damage.
- Do not spin the wheels, especially at speeds more than 56 km/h (35 mph). Spinning the wheels at high speeds when the vehicle is stationary could overheat and damage tyres, and the rotating wheels may fly away and injure bystanders.

* NOTICE

The Electronic Stability Control (ESC) should be turned OFF prior to rocking the vehicle.

Smooth cornering

Avoid braking or gear changing in corners, especially when roads are wet. Ideally, corners should always be taken under gentle acceleration. If you follow these suggestions, tyre wear will be held to a minimum.

Driving at night

Because night driving presents more hazards than driving in the daylight, here are some important tips to remember:

- Slow down and keep more distance between you and other vehicles, as it may be more difficult to see at night, especially in areas where there may not be any street lights.
- Adjust your mirrors to reduce the glare from other driver's headlights.
- Keep your headlights clean and properly aimed. (On vehicles not equipped with the automatic headlight aiming feature.) Dirty or improperly aimed headlights will make it much more difficult to see at night.
- Avoid staring directly at the headlights of oncoming vehicles. You could be temporarily blinded, and it will take several seconds for your eyes to readjust to the darkness.

Driving in the rain

Rain and wet roads can make driving dangerous, especially if you're not prepared for the slick pavement.

Here are a few things to consider when driving in the rain:

- A heavy rainfall will make it harder to see and will increase the distance needed to stop your vehicle, so slow down.
- Keep your windscreen wiping equipment in good shape. Replace your windscreen wiper blades when they show signs of streaking or missing areas on the windscreen.
- If your tyres are not in good condition, making a quick stop on wet pavement can cause a skid and possibly lead to an accident. Be sure your tyres are in good shape.
- Turn on your headlights to make it easier for others to see you.
- Driving too fast through large puddles can affect your brakes. If you must go through puddles, try to drive through them slowly.
- If you believe you may have gotten your brakes wet, apply them lightly whilst driving until normal braking operation returns.

Hydroplaning

If the road is wet enough and you are going fast enough, your vehicle may have little or no contact with the road surface and actually ride on the water. The best advice is SLOW DOWN when the road is wet.

The risk of hydroplaning increases as the depth of tyre tread decreases, refer to "Wheel replacement" on page 9-52.

Driving in flooded areas

Avoid driving through flooded areas unless you are sure the water is no higher than the bottom of the wheel hub. Drive through any water slowly. Allow adequate stopping distance because brake performance may be affected.

After driving through water, dry the brakes by gently applying them several times whilst the vehicle is moving slowly.

Driving off-road

Drive carefully off-road because your vehicle may be damaged by rocks or roots of trees. Become familiar with the off-road conditions where you are going to drive before you begin driving.

Highway driving

Tyres

Adjust the tyre inflation pressures to specification. Low tyre inflation pressures will result in overheating and possible failure of the tyres.

Avoid using worn or damaged tyres which may result in reduced traction or tyre failure.

Never exceed the maximum tyre inflation pressure shown on the tyres.

WARNING

- Always check the tyres for proper inflation before driving. Underinflated or overinflated tyres can cause poor handling, loss of vehicle control, and sudden tyre failure, leading to accidents, injuries, and even death. For proper tyre pressures, refer to "Tyres and wheels" on page 10-6.

- Always check the tyre tread before driving your vehicle. Worn-out tyres can result in loss of vehicle control. Worn-out tyres should be replaced as soon as possible. For further information and tread limits, refer to "Tyres and wheels" on page 10-6.
-

Fuel, engine coolant and engine oil

High speed travel consumes more fuel than urban motoring. Do not forget to check both the engine coolant and engine oil.

Drive belt

A loose or damaged drive belt may result in overheating of the engine.

Winter driving

Severe weather conditions in the winter result in greater wear and other problems.

To minimise the problems of winter driving, you should follow these suggestions:

Snowy or icy conditions

To drive your vehicle in deep snow, it may be necessary to use snow tyres or to install tyre chains on your tyres.

If snow tyres are needed, it is necessary to select tyres equivalent in size and type of the original equipment tyres. Failure to do so may adversely affect the safety and handling of your vehicle. Furthermore, speeding, rapid acceleration, sudden brake applications, and sharp turns are potentially very hazardous practices.

During deceleration, use vehicle braking to the fullest extent. Sudden brake applications on snowy or icy roads may cause skids to occur. You need to keep sufficient distance between the vehicle in operation in front of your vehicle. Also, apply the brake gently. It should be noted that installing tyre chains on the tyre will provide a greater driving force, but will not prevent side skids.

Tyre chains are not legal in all states. Check state laws before fitting tyre chains.

Snow tyres

If you mount snow tyres on your vehicle, make sure they are radial tyres of the same size and load range as the original tyres. Mount snow tyres on all four wheels to balance your vehicle's handling in all weather conditions. Keep in

mind that the traction provided by snow tyres on dry roads may not be as high as your vehicle's original equipment tyres. You should drive cautiously even when the roads are clear. Check with the tyre dealer for maximum speed recommendations.

Do not install studded tyres without first checking local, state and municipal regulations for possible restrictions against their use.

⚠ WARNING

Snow tyres should be equivalent in size and type to the vehicle's standard tyres. Otherwise, the safety and handling of your vehicle may be adversely affected.

Tyre chains

wire-type



fabric-type



Since the sidewalls of radial tyres are thinner, they can be damaged by mounting some types of snow chains on them. Therefore, the use of snow tyres is recommended instead of snow chains. Do not mount tyre chains on vehicles equipped with aluminium wheels; snow

chains may cause damage to the wheels. If snow chains must be used, use fabric-type chains or wire-type chains with a thickness of less than 12 mm (0.47 in).

Damage to your vehicle caused by improper snow chain use is not covered by your vehicle manufacturer's warranty. When using tyre chains, attach them to the drive wheels as follows.

- Front wheel drive vehicle moves the front wheel as a power source. Thus, snow chains must be mounted to front tyres.
- All wheel drive vehicle must mount snow chains to front tyres only. In this case, minimise the driving distance in order to prevent damage to the all wheel drive system.
- After mounting snow chains, drive slowly. If you hear noise caused by chains contacting the body, slow down until the noise stops and remove the chain as soon as you begin driving on cleared roads to prevent damage.
- Wrong size chains or improperly installed chains can damage your vehicle's brake lines, suspension, body and wheels. Therefore, when installing snow chain, follow the manufacturer's instructions and mount them as tightly possible. Drive slowly (less than 30 km/h (20 mph)) with chains installed.

⚠ CAUTION

- Make sure the snow chains are the correct size and type for your tyres. Incorrect snow chains can cause damage to the vehicle body and suspension and may not be covered by your vehicle manufacturer warranty. Also, the snow chain connecting hooks may

be damaged from contacting vehicle components causing the snow chains to come loose from the tyre. Make sure the snow chains are SAE class "S" certified.

- Always check chain installation for proper mounting after driving approximately 0.5 to 1 km (0.3 to 0.6 miles) to ensure safe mounting. Retighten or remount the chains if they are loose.
- Fabric-type chains must be used on the vehicle with 18 inch (235/60R18) or 19 inch (235/55R19) tyres.

Use high quality ethylene glycol coolant

Your vehicle is delivered with high quality ethylene glycol coolant in the cooling system. It is the only type of coolant that should be used because it helps prevent corrosion in the cooling system, lubricates the water pump and prevents freezing. Be sure to replace or replenish your coolant in accordance with the maintenance schedule in section 8.

Before winter, have your coolant tested to assure that its freezing point is sufficient for the temperatures anticipated during the winter.

Check battery and cables

Winter puts additional burdens on the battery system. Visually inspect the battery and cables as described in section 8. Have the level of charge in your battery checked by a professional workshop. Kia recommends to visit an authorised Kia dealer/service partner.

Change to "winter weight" oil if necessary

In some climates it is recommended that a lower viscosity "winter weight" oil be used during cold weather. See "Recommended lubricants and capacities" on page 10-7. If you aren't sure what weight oil you should use, Kia recommends to consult an authorised Kia dealer/service partner.

Check spark plugs and ignition system

Inspect your spark plugs as described in "Scheduled maintenance service" on page 9-9 and replace them if necessary. Also check all ignition wiring and components to be sure they are not cracked, worn or damaged in any way.

To keep locks from freezing

To keep the locks from freezing, squirt an approved de-icer fluid or glycerine into the key opening. If a lock is covered with ice, squirt it with an approved de-icing fluid to remove the ice. If the lock is frozen internally, you may be able to thaw it out by using a heated key. Handle the heated key with care to avoid injury.

Use approved window washer anti-freeze in system

To keep the water in the window washer system from freezing, add an approved window washer anti-freeze solution in accordance with instructions on the container. Window washer anti-freeze is available from an authorised Kia dealer/service partner and most auto parts outlets. Do not use engine coolant or other

types of anti-freeze as these may damage the paint finish.

Don't let your parking brake freeze

Under some conditions your parking brake can freeze in the engaged position. This is most likely to happen when there is an accumulation of snow or ice around or near the rear brakes or if the brakes are wet. If there is a risk the parking brake may freeze, temporarily apply it with the gear in P (Park). Also, block the rear wheels in advance, so the vehicle may not roll. Then release the parking brake.

Don't let ice and snow accumulate underneath

Under some conditions, snow and ice can build up under the fenders and interfere with the steering. When driving in severe winter conditions where this may happen, you should periodically check underneath the vehicle to be sure the movement of the front wheels and the steering components is not obstructed.

Carry emergency equipment

Depending on the severity of the weather, you should carry appropriate emergency equipment. Some of the items you may want to carry include tyre chains, tow straps or chains, flashlight, emergency flares, sand, shovel, jumper cables, window scraper, gloves, ground cloth, coveralls, blanket, etc.

Drive your vehicle when water vapour condenses and accumulates inside the exhaust pipes

When the vehicle is stopped for a long time in winter whilst the engine is running, water vapour may condense and accumulate inside the exhaust pipes. Water in the exhaust pipes may cause noise, etc., but it is drained driving at medium to high speed.

Trailer towing (if equipped)

If you are considering towing with your vehicle, you should first check with your country's Department of Motor Vehicles to determine their legal requirements.

Since laws vary the requirements for towing trailers, cars, or other types of vehicles or apparatus may differ. Kia recommends to ask an authorised Kia dealer/service partner.

Your vehicle can tow a trailer. To identify what the vehicle trailering capacity is for your vehicle, refer to "Weight of the trailer" on page 6-60 that appears later in this section.

Remember that trailering is different than just driving your vehicle by itself. Trailering means changes in handling, durability, and fuel economy. Successful, safe trailering requires correct equipment, and it has to be used properly.

This section contains many timetested, important trailering tips and safety rules. Many of these are important for your safety and that of your passengers. Please read this section carefully before you pull a trailer.

Load-pulling components such as the engine, transmission, wheel assemblies, and tyres are forced to work harder against the load of the added weight. The engine is required to operate at relatively higher speeds and under greater loads. This additional burden generates extra heat. The trailer also considerably adds wind resistance, increasing pulling requirements.

WARNING

- If you don't use the correct equipment and drive improperly, you can lose control when you pull a trailer. For example, if the trailer is too heavy, the

brakes may not work well - or even at all. You and your passengers could be seriously or fatally injured. Pull a trailer only if you have followed all the steps in this section.

- Before towing, make sure the total trailer weight, gross combination weight, gross vehicle weight, gross axle weight and trailer tongue load are all within the limits.

CAUTION

- Any part of the rear number plate or lighting devices of the vehicle must not be obscured by the mechanical coupling device. If the rear number plate and/or lighting devices can be obscured partially by any part of the mechanical coupling device, mechanical coupling devices that can not be easily removed or repositioned without use of any tool, except an easily operated (i.e. an effort not exceeding 20 N·m) release key which is supplied by the manufacturer of the coupling device, are not permitted for use. Please note that the mechanical coupling device that is fitted and not in use must always be removed or repositioned if the rear number plate and/or rear lighting devices are obscured by any part of the mechanical coupling device.
- Pulling a trailer improperly can damage your vehicle and result in costly repairs not covered by your warranty. To pull a trailer correctly, follow the advice in this section.

NOTICE

- The mounting hole for hitches are located on both sides of the underbody behind the rear tyres.

- **For Europe**

- The technically permissible maximum load on the rear axle(s) may be exceeded by not more than 15% and the technically permissible maximum laden mass of the vehicle may be exceeded by not more than 10% or 100 kg (220.4 lbs), whichever value is lower. In this case, do not exceed 100 km/h (62.1 mph) for vehicle of category M1 or 80 km/h (49.7 mph) for vehicle of category N1.
- When towing a trailer, the additional load imposed at the trailer coupling device may cause the rear tyre maximum load ratings to be exceeded, but not by more than 15%. In such a case, do not exceed 100km/h, and the rear tyre pressure should be at least 20 kPa(0.2 bar) above the tyre pressure(s) as recommended for normal use (i.e. without a trailer attached).

Hitches

It's important to have the correct hitch equipment. Crosswinds, large trucks going by, and rough roads are a few reasons why you'll need the right hitch. Here are some rules to follow:

- Do you have to make any holes in the body of your vehicle when you install a trailer hitch? If you do, then be sure to seal the holes later when you remove the hitch.
If you don't seal them, deadly carbon monoxide (CO) from your exhaust can get into your vehicle, as well as dirt and water.
- The bumpers on your vehicle are not intended for hitches. Do not attach rental hitches or other bumper-type

hitches. Use only a frame-mounted hitch that does not attach to the bumper.

- Any part of the rear number plate or lighting devices of the vehicle must not be obscured by the mechanical coupling device.

If the rear number plate and/or lighting devices can be obscured partially by any part of the mechanical coupling device, mechanical coupling devices that can not be easily removed or repositioned without use of any tools, except an easily operated (i.e. an effort not exceeding 20 Nm) release key which is supplied by the manufacturer of the coupling device, are not permitted for use.

Please note that the mechanical coupling device that is fitted and not in use must always be removed or repositioned if the rear number plate and/or rear lighting devices are obscured by any part of the mechanical coupling device.

- Kia trailer hitch accessory is available at an authorised Kia dealer/service partner.

Safety chains

You should always attach chains between your vehicle and your trailer. Cross the safety chains under the tongue of the trailer so that the tongue will not drop to the road if it becomes separated from the hitch.

Instructions about safety chains may be provided by the hitch manufacturer or by the trailer manufacturer. Follow the manufacturer's recommendation for attaching safety chains. Always leave just enough slack so you can turn with your trailer. And, never allow safety chains drag on the ground.

Trailer brakes

If your trailer is equipped with a braking system, make sure it conforms to your country's regulations and that it is properly installed and operating correctly.

If your trailer weighs more than the maximum trailer weight without trailer brakes loaded, then it needs its own brakes and they must be adequate. Be sure to read and follow the instructions for the trailer brakes so you'll be able to install, adjust and maintain them properly.

- Don't tap into your vehicle's brake system.

WARNING

Do not use a trailer with its own brakes unless you are absolutely certain that you have properly set up the brake system. This is not a task for amateurs. Use an experienced, competent trailer shop for this work.

Driving with a trailer

Towing a trailer requires a certain amount of experience. Before setting out for the open road, you must get to know your trailer. Acquaint yourself with the feel of handling and braking with the added weight of the trailer. And always keep in mind that the vehicle you are driving is now a good deal longer and not nearly so responsive as your vehicle is by itself.

Before you start, check the trailer hitch and platform, safety chains, electrical connector(s), lights, tyres and mirror adjustment. If the trailer has electric brakes, start your vehicle and trailer moving and then apply the trailer brake controller by hand to be sure the brakes

are working. This lets you check your electrical connection at the same time. During your trip, check occasionally to be sure that the load is secure, and that the lights and trailer brakes are still working.

Following distance

Stay at least twice as far behind the vehicle ahead as you would when driving your vehicle without a trailer. This can help you avoid situations that require heavy braking and sudden turns.

Passing

You'll need more passing distance up ahead when you're towing a trailer. And, because of the increased vehicle length, you'll need to go much farther beyond the passed vehicle before you can return to your lane.

Backing up

Hold the bottom of the steering wheel with one hand. Then, to move the trailer to the left, just move your hand to the left. To move the trailer to the right, move your hand to the right. Always back up slowly and, if possible, have someone guide you.

Making turns

When you're turning with a trailer, make wider turns than normal. Do this so your trailer won't strike soft shoulders, kerbs, road signs, trees, or other objects. Avoid jerky or sudden manoeuvres. Signal well in advance.

Turn signals when towing a trailer

When you tow a trailer, your vehicle has to have a different turn signal flasher and extra wiring. The green arrows on your instrument panel will flash whenever you signal a turn or lane change. Properly connected, the trailer lights will also flash to alert other drivers you're about to turn, change lanes, or stop.

When towing a trailer, the green arrows on your instrument panel will flash for turns even if the bulbs on the trailer are burned out. Thus, you may think drivers behind you are seeing your signals when, in fact, they are not. It's important to check occasionally to be sure the trailer bulbs are still working. You must also check the lights every time you disconnect and then reconnect the wires.

Do not connect a trailer lighting system directly to your vehicle's lighting system. Use only an approved trailer wiring harness.

Have yourself assisted by a professional workshop in installing the wiring harness.

Kia recommends to visit an authorised Kia dealer/service partner.

WARNING

Failure to use an approved trailer wiring harness could result in damage to the vehicle electrical system and/or personal injury.

Detection of trailer light connection

This functionality is only given with genuine accessories (tow bar and wiring harness) that recognise when a trailer is connected and consequently inform the

vehicle systems. Trailer recognition works as follows: when a trailer socket is plugged in, either the brake pedal shall be pushed or turn signal lamps activated; the electronic control unit will then detect the trailer because of the power consumption by the trailer lighting and inform the vehicle systems. When the trailer is disconnected, the brake pedal shall be pushed again or turn signal lamps activated for the control unit to be able to detect that there is no power consumption anymore by trailer lighting; the assistance systems that were turned off will automatically turn on again.

It is the driver's responsibility to ensure that all electrical connections are working and all trailer lights are operating before and during towing. You must perform manual checks.

CAUTION

Use only genuine electrical connections. Do not attempt to arbitrarily splice or directly connect the trailer wiring using any other methods. Doing so may damage the vehicle's electrical system, resulting in malfunctions.

Driving on grades

Reduce the speed and shift to a lower gear before you start down a long or steep downgrade. If you don't shift down, you might have to use your brakes so much that they would get hot and no longer operate efficiently.

On a long uphill grade, shift down and reduce your speed to around 70 km/h (45 mph) to reduce the possibility of engine and transmission overheating.

⚠ CAUTION

- When towing a trailer on steep grades (in excess of 6%) pay close attention to the engine coolant temperature gauge to ensure the engine does not overheat. If the needle of the coolant temperature gauge moves across the dial towards "H (HOT) (or 130°C/ 260°F)", pull over and stop as soon as it is safe to do so, and allow the engine to idle until it cools down. You may proceed once the engine has cooled sufficiently.
- You must decide the driving speed depending on trailer weight and uphill grade to reduce the possibility of engine and transmission overheating.

Parking on hills

Generally, if you have a trailer attached to your vehicle, you should not park your vehicle on a hill. People can be seriously or fatally injured, and both your vehicle and the trailer can be damaged if unexpectedly roll down hill.

However, if you ever have to park your trailer on a hill, here's how to do it:

1. Pull the vehicle into the parking space. Turn the steering wheel in the direction of the kerb (left if headed down hill, right if headed up hill).
2. Set the parking brake and shut off the vehicle.
3. Place chocks under the trailer wheels on the down hill side of the wheels.
4. Start the vehicle, hold the brakes, shift to neutral, release the parking brake and slowly release the brakes until the trailer chocks absorb the load.
5. Reapply the brakes, reapply the parking brake.

6. Shut off the vehicle and release the vehicle brakes but leave the parking brake set.

⚠ WARNING

- Parking your vehicle on a hill with a trailer attached could cause serious injury or death, should the trailer break loose.
- It can be dangerous to get out of your vehicle if the parking brake is not firmly set. If you have left the engine running, the vehicle can move suddenly. You or others could be seriously or fatally injured.

When you are ready to leave after parking on a hill

1. Apply your brakes and hold the brake pedal down whilst you:
 - Start your engine;
 - Shift into gear; and
 - Release the parking brake.
2. Slowly remove your foot from the brake pedal.
3. Drive slowly until the trailer is clear of the chocks.
4. Stop and have someone pick up and store the chocks.

Maintenance when trailer towing

Your vehicle will need service more often when you regularly pull a trailer. Important items to pay particular attention to include engine oil, axle lubricant and cooling system fluid. Brake condition is another important item to frequently check. Each item is covered in this manual, and the Index will help you find them quickly. If you're trailering, it's a good idea to review these sections before you start your trip.

Don't forget to also maintain your trailer and hitch. Follow the maintenance schedule that accompanied your trailer and check it periodically. Preferably, conduct the check at the start of each day's driving. Most importantly, all hitch nuts and bolts should be tight.

CAUTION

- Due to higher load during trailer usage, overheating might occur in hot days or during uphill driving. If the coolant gauge indicates overheating, switch off the A/C and stop the vehicle in a safe area to cool down the engine.
 - When towing, check the transmission fluid more frequently.
 - If your vehicle is not equipped with an air conditioner, you should install a condenser fan to improve engine performance when towing a trailer.
- On a long uphill grade, do not exceed 70 km/h (45 mph) or the posted towing speed limit, whichever is lower.
 - The chart contains important considerations that have to do with weight:

If you do decide to pull a trailer

Here are some important points if you decide to pull a trailer:

- Consider using a sway control. You can ask a hitch dealer about sway control.
- Do not do any towing with your vehicle during its first 2,000 km (1,200 miles) in order to allow the engine to properly break in. Failure to heed this caution may result in serious engine or transmission damage.
- When towing a trailer, Kia recommends that you consult an authorised Kia dealer/service partner on additional requirements such as a towing kit, etc.
- Always drive your vehicle at a moderate speed (less than 100 km/h (60 mph)).

Reference weight and distance when towing a trailer

| Item | | Petrol Engine | | | | Diesel Engine |
|---|----------------------|--------------------------|--------------------------|--------------------------|--|--------------------------|
| | | Smartstream G1.6 T-GDi | Smartstream G2.0 | | Smartstream G2.5 GDi | Smartstream D2.0 |
| | | | DCT | MT | AT | |
| Maximum trailer weight | With brake system | 1,650 kg (3,638 lbs.) | 1,900 kg (4,188 lbs.) | 1,650 kg (3,638 lbs.) | Type A: 1,650 kg (3,638 lbs.) Type B: 1,500 kg (3,307 lbs.) | 1,900 kg (4,188 lbs.) |
| | Without brake system | 750 kg (1,653 lbs.) | | | | |
| Maximum permissible static vertical load on the coupling device | | 100 kg (220 lbs.) | | | | |
| Recommended distance from rear wheel centre to coupling point | | 1,077 mm (42.4 inch) | | | | |

Weight of the trailer

What is the maximum safe weight of a trailer? It should never weigh more than the maximum trailer weight with trailer brakes. But even that can be too heavy. It depends on how you plan to use your trailer. For example, speed, altitude, road grades, outside temperature and how often your vehicle is used to pull a trailer are all important. The ideal trailer weight can also depend on any special equipment that you have on your vehicle.

- Never exceed the maximum weight limits of the trailer or trailer towing equipment. Improper loading can result in damage to your vehicle and/or personal injury. Check weights and loading at a commercial scale or highway patrol office equipped with scales.
 - An improperly loaded trailer can cause loss of vehicle control.
-

Weight of the trailer tongue

The tongue load of any trailer is an important weight to measure because it affects the total gross vehicle weight (GVW) of your vehicle. This weight includes the kerb weight of the vehicle, any cargo you may carry in it, and the people who will be riding in the vehicle. And if you tow a trailer, you must add the tongue load to the GVW because your vehicle will also be carrying that weight.

The trailer tongue should weigh a maximum of 10% of the total loaded trailer weight, within the limits of the maximum trailer tongue load permissible.

After you've loaded your trailer, weigh the trailer and then the tongue, separately, to see if the weights are proper. If they aren't, you may be able to correct them simply by moving some items around in the trailer.

WARNING

- Never load a trailer with more weight in the rear than in the front. The front should be loaded with approximately 60% of the total trailer load; the rear should be loaded with approximately 40% of the total trailer load.

Vehicle weight

This section will guide you in the proper loading of your vehicle, to keep your loaded vehicle weight within its design rating capability. Properly loading your vehicle will provide maximum return of the vehicle design performance. Before loading your vehicle, familiarize yourself with the following terms for determining your vehicle's weight ratings, from the vehicle's specifications and the certification label:

Base kerb weight

This is the weight of the vehicle including a full tank of fuel and all standard equipment. It does not include passengers, cargo, or optional equipment.

Vehicle kerb weight

This is the weight of your new vehicle when you picked it up from your dealer plus any aftermarket equipment.

Cargo weight

This figure includes all weight added to the Base Kerb Weight, including cargo and optional equipment.

GAW (Gross axle weight)

This is the total weight placed on each axle (front and rear) - including vehicle kerb weight and all payload.

GAWR (Gross axle weight rating)

This is the maximum allowable weight that can be carried by a single axle (front or rear). These numbers are shown on the certification label (if equipped).

The total load on each axle must never exceed its GAWR.

GVW (Gross vehicle weight)

This is the Base Kerb Weight plus actual Cargo Weight plus passengers.

GVWR (Gross vehicle weight rating)

This is the maximum allowable weight of the fully loaded vehicle (including all options, equipment, passengers and cargo). The GVWR is shown on the certification label (if equipped) located on the driver's (or front passenger's) door sill.

Overloading

Vehicle weight

The gross axle weight rating (GAWR) and the gross vehicle weight rating (GVWR) for your vehicle are on the certification label attached to the driver's (or front passenger's) door. Exceeding these ratings can cause an accident or vehicle damage. You can calculate the weight of your load by weighing the items (and people) before putting them in the vehicle. Be careful not to overload your vehicle.

Loading Your Vehicle (if equipped)

Certification Label (if equipped)



Tyre Label



The Certification/Tyre label is found on the front edge of the RH (or LH) "B" pillar. The label shows the size of your original tyres and inflation pressures needed to obtain the gross weight capacity of your vehicle.

This is called the GVWR (Gross Vehicle Weight Rating). The GVWR includes the weight of the vehicle, all occupants, fuel and cargo. The Certification/Tyre label also tells you the maximum weights for the front and rear axles, called Gross Axle Weight Rating (GAWR).

| | |
|---|-------------|
| Forward Collision-Avoidance Assist (FCA) (Front Camera Only) | 7-5 |
| • Forward Collision-Avoidance Assist settings | 7-5 |
| • Forward Collision-Avoidance Assist operation | 7-7 |
| • Forward Collision-Avoidance Assist malfunction and limitations | 7-9 |
| Forward Collision-Avoidance Assist (FCA) (Sensor Fusion).. | 7-14 |
| • Forward Collision-Avoidance Assist settings | 7-16 |
| • Forward Collision-Avoidance Assist operation | 7-18 |
| • Forward Collision-Avoidance Assist malfunction and limitations | 7-21 |
| Lane Keeping Assist (LKA)..... | 7-26 |
| • Lane Keeping Assist settings | 7-27 |
| • Lane Keeping Assist operation..... | 7-28 |
| • Lane Keeping Assist malfunction and limitations..... | 7-30 |
| Blind-Spot Collision Warning (BCW) | 7-32 |
| • Blind-Spot Collision Warning settings..... | 7-33 |
| • Blind-Spot Collision Warning operation | 7-34 |
| • Blind-Spot Collision Warning malfunction and limitations | 7-36 |
| Blind-Spot Collision-Avoidance Assist (BCA) | 7-39 |
| • Blind-Spot Collision-Avoidance Assist settings..... | 7-41 |
| • Blind-Spot Collision-Avoidance Assist operation | 7-43 |
| • Blind-Spot Collision-Avoidance Assist malfunction and limitations | 7-46 |
| Safe Exit Warning (SEW) | 7-50 |
| • Safe Exit Warning settings | 7-50 |
| • Safe Exit Warning operation | 7-51 |
| • Safe Exit Warning malfunction and limitations | 7-52 |
| Manual Speed Limit Assist (MSLA) | 7-54 |
| • Manual Speed Limit Assist operation..... | 7-54 |

7 Driver assistance system

| | |
|---|-------------|
| Intelligent Speed Limit Assist (ISLA) | 7-56 |
| • Intelligent Speed Limit Assist settings | 7-56 |
| • Intelligent Speed Limit Assist operation | 7-57 |
| • Intelligent Speed Limit Assist malfunction and limitations..... | 7-59 |
| Driver Attention Warning (DAW) | 7-61 |
| • Driver Attention Warning settings | 7-61 |
| • Driver Attention Warning operation | 7-62 |
| • Driver Attention Warning malfunction and limitations | 7-64 |
| Blind-Spot View Monitor (BVM) | 7-66 |
| • Blind-Spot View Monitor settings | 7-66 |
| • Blind-Spot View Monitor operation..... | 7-67 |
| • Blind-Spot View Monitor malfunction..... | 7-67 |
| Cruise Control (CC) | 7-68 |
| • Cruise Control operation | 7-68 |
| Smart Cruise Control (SCC) | 7-70 |
| • Smart Cruise Control settings | 7-71 |
| • Smart Cruise Control operation..... | 7-74 |
| • Smart Cruise Control display and control..... | 7-74 |
| • Smart Cruise Control malfunction and limitations..... | 7-78 |
| Lane Following Assist (LFA) | 7-83 |
| • Lane Following Assist settings | 7-83 |
| • Lane Following Assist operation..... | 7-84 |
| • Lane Following Assist malfunction and limitations..... | 7-85 |
| Rear View Monitor (RVM) | 7-86 |
| • Rear View Monitor settings | 7-86 |
| • Warning methods | 7-86 |
| • Rear View Monitor operation..... | 7-87 |
| • Rear View Monitor malfunction and limitations..... | 7-88 |
| Surround View Monitor (SVM) | 7-89 |
| • Surround View Monitor settings..... | 7-89 |

| | |
|---|--------------|
| • Surround View Monitor operation | 7-91 |
| • Surround View Monitor malfunction and limitations | 7-93 |
| Rear Cross-Traffic Collision Warning (RCCW) | 7-94 |
| • Rear Cross-Traffic Collision Warning settings | 7-94 |
| • Rear Cross-Traffic Collision Warning operation | 7-95 |
| • Rear Cross-Traffic Collision Warning malfunction and limitations | 7-97 |
| Rear Cross-Traffic Collision-Avoidance Assist (RCCA) | 7-100 |
| • Rear Cross-Traffic Collision-Avoidance Assist settings | 7-101 |
| • Rear Cross-Traffic Collision-Avoidance Assist operation | 7-102 |
| • Rear Cross-Traffic Collision-Avoidance Assist malfunction and limitations | 7-105 |
| Reverse Parking Distance Warning (PDW) | 7-109 |
| • Reverse Parking Distance Warning settings | 7-109 |
| • Reverse Parking Distance Warning operation | 7-110 |
| • Reverse Parking Distance Warning malfunction and precautions | 7-111 |
| Forward/Reverse Parking Distance Warning (PDW) | 7-112 |
| • Forward/Reverse Parking Distance Warning settings | 7-113 |
| • Forward/Reverse Parking Distance Warning operation | 7-113 |
| • Forward/Reverse Parking Distance Warning malfunction and precautions | 7-115 |
| Reverse Parking Collision-Avoidance Assist (PCA) | 7-117 |
| • Reverse Parking Collision-Avoidance Assist settings | 7-117 |
| • Reverse Parking Collision-Avoidance Assist operation | 7-118 |
| • Reverse Parking Collision-Avoidance Assist malfunction and limitations | 7-119 |
| Remote Smart Parking Assist (RSPA) | 7-123 |
| • Remote Smart Parking Assist settings | 7-124 |
| • Remote Smart Parking Assist operation | 7-126 |
| • Remote Smart Parking Assist malfunction and limitations | 7-130 |

7 Driver assistance system

Declaration of conformity 7-134

Driver assistance system

* INFORMATION

The infotainment system may change after software updates. The information displayed on the infotainment system may not have some menu or may appear different from this user manual depending on the specifications of your vehicle. For more details, access the manual using the QR code in the infotainment system quick reference guide.

Forward Collision-Avoidance Assist (FCA) (Front Camera Only) (if equipped)



Forward Collision-Avoidance Assist is designed to help detect and monitor the vehicle ahead or help detect a pedestrian or cyclist in the roadway and warn the driver that a collision is imminent with a warning message and an audible warning, apply emergency braking.

Detecting sensor

Front view camera



Refer to the picture above for the detailed location of the detecting sensor.

⚠ CAUTION

- Never disassemble the detecting sensor or sensor assembly, or apply any impact on it.
- If the detecting sensors have been replaced or repaired, have the vehicle inspected by a professional workshop. Kia recommends visiting an authorised Kia dealer/service partner.
- Never install any accessories or stickers on the front windscreen, or tint the front windscreen.
- Pay extreme caution to keep the front view camera dry.
- Never place any reflective objects (i.e. white paper, mirror) over the instrument panel.

Forward Collision-Avoidance Assist settings

Forward Safety

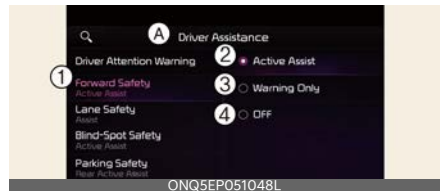
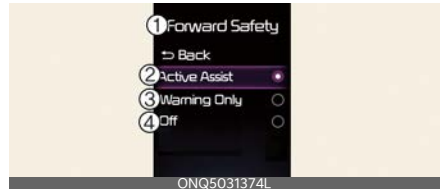

A: Driver assistance

- 1 Forward safety
- 2 Active Assist
- 3 Warning Only
- 4 Off

With the vehicle on, select **Driver assistance** → **Forward safety** from the Settings menu to set whether or not to use each function.

- **Active Assist:** Forward Collision-Avoidance Assist will warn the driver with a warning message, an audible warning and steering wheel vibration (if equipped) depending on the collision risk levels. Braking assist or steering assist (if equipped) will be applied depending on the collision risk.
- **Warning Only:** Forward Collision-Avoidance Assist will warn the driver with a warning message, an audible warning and steering wheel vibration (if equipped) depending on the collision risk levels. Braking and steering (if equipped) will not be assisted. The driver must apply the brake pedal or steer the vehicle if necessary.
- **Off:** Forward Collision-Avoidance Assist will turn off. The warning light (🚨) will appear on the cluster.

The driver can monitor Forward Collision-Avoidance Assist ON/OFF status from the Settings menu. If the warning light (🚨) remains ON when Forward Collision-Avoidance Assist is ON, have the vehicle inspected by a professional workshop. Kia recommends visiting an authorised Kia dealer/service partner.

⚠ WARNING

When the vehicle is restarted, Forward Collision-Avoidance Assist will always turn on. However, if **Off** is selected, the driver should always be aware of the surroundings and drive safely.

⚠ CAUTION

- If **Warning only** is selected, braking and steering (if equipped) is not assisted.
- Steering wheel vibration (if equipped) can be turned on or off. Select or deselect **Driver assistance** → **Haptic warning** from the Settings menu.

*** NOTICE**

Forward Collision-Avoidance Assist will turn off when ESC is turned off by pressing and holding the ESC OFF button. The warning light (🚨) will appear on the cluster.

Warning timing



A: Driver assistance

- 1 Warning timing**
- 2 Normal**
- 3 Late**

With the vehicle on, select **Driver assistance** → **Warning timing** from the Settings menu to change the initial warning activation time for Forward Collision-Avoidance Assist.

- **Normal:** Use in a normal driving environment. If the function operates too

sensitively, set to the warning timing to **Late**.

- **Late:** The warning timing will be slow.

Warning methods

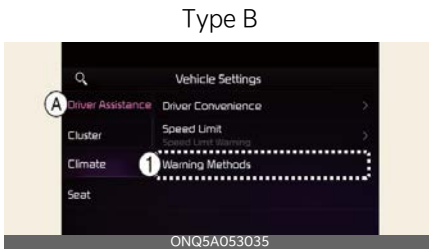
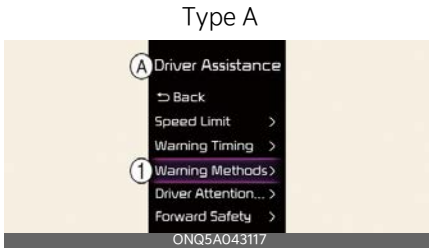

A: Driver Assistance

1 Warning Methods

The Warning Methods can be set with the vehicle on. Select **User Settings** → **Driver Assistance** → **Warning Methods** from the settings menu in the instrument cluster or **Settings** → **Vehicle** → **Driver Assistance** → **Warning Methods** from the settings menu in the infotainment system to change the following settings:

- **Warning Volume:** Adjusts the volume of the warning sound.
- **Haptic Warning:** Activate the steering wheel vibration warning. (if equipped)
- **Driving Safety Priority:** Lowers all other audio volumes when the Driving Safety system sounds a warning.

* INFORMATION

- If you change the Warning Methods, it can be applied to each function of the driver assistance system. Please check and change it in each function.
- If the vehicle is restarted, Warning Methods will maintain the last setting.
- The setting menu may not exist based on vehicle specification.
- The **Warning Volume** and **Haptic Warning** cannot be turned off at the same time. When one of the warning is turned off the other is activated.

Forward Collision-Avoidance Assist operation

Warning and control

The basic function for Forward Collision-Avoidance Assist is warned and controlled by the following level.

- Collision Warning
- Emergency Braking
- Stopping vehicle and ending brake control

Collision Warning



A: Collision Warning

The warning message, an audible warning and the steering wheel will vibrate (if equipped) to warn the driver of a collision. If **Active Assist** is selected, braking may be assisted.

Collision Warning will be activated in the following your vehicle speed conditions,

depending on the target ahead and the collision risk level when:

- A vehicle is detected and your vehicle speed is approximately 5~180 km/h (3~112 mph).
- A pedestrian or cyclist is detected and your vehicle speed is approximately 5~80 km/h (3~50 mph).

Emergency braking



A: Emergency braking

The warning message, an audible warning and the steering wheel will vibrate (if equipped) to warn the driver that emergency braking will be assisted. The brake assist will be activated and it helps avoiding collision of a vehicle, pedestrian and cyclist.

Emergency Braking will be activated in the following your vehicle speed conditions, depending on the target ahead and the collision risk level when:

- A vehicle is detected and your vehicle speed is approximately 5~60 km/h (3~37 mph).
- A pedestrian or cyclist is detected and your vehicle speed is approximately 5~60 km/h (3~37 mph).

Stopping vehicle and ending brake control



A: Drive carefully

When the vehicle is stopped due to emergency braking, the warning message will appear on the cluster.

For your safety, the driver should depress the brake pedal immediately and check the surroundings.

- Brake control will end after the vehicle is stopped by emergency braking for approximately 2 seconds.

⚠ WARNING

- For your safety, change the Settings after parking the vehicle at a safe location.
- With **Active Assist** or **Warning only** selected, when ESC is turned off by pressing and holding the ESC OFF button, Forward Collision-Avoidance Assist will turn off automatically. In this case, Forward Collision-Avoidance Assist cannot be set from the Settings menu and the (⚠) warning light will appear on the cluster which is normal. If ESC is turned on by pressing the ESC OFF button again, Forward Collision-Avoidance Assist will maintain the last setting. Forward Collision-Avoidance Assist does not operate in all situations or cannot avoid all collisions.
- The driver should hold the responsibility to control the vehicle. Do not solely depend on Forward Collision-

Avoidance Assist. Rather, maintain a safe braking distance, and if necessary, depress the brake pedal to reduce driving speed or to stop the vehicle.

- Never deliberately operate Forward Collision-Avoidance Assist on people, objects, etc. It may cause serious injury or death.
- Forward Collision-Avoidance Assist may not operate if the driver depresses the brake pedal to avoid collision.
- Depending on the road and driving conditions, Forward Collision-Avoidance Assist may warn the driver late or may not warn the driver.
- During Forward Collision-Avoidance Assist operation, the vehicle may stop suddenly injuring passengers and shifting loose objects. Always have the seat belt on and keep loose objects secured.
- If any other function's warning message is displayed or audible warning is generated, Forward Collision-Avoidance Assist warning message may not be displayed and audible warning may not be generated.
- You may not hear the warning sound of Forward Collision-Avoidance Assist if the surroundings are noisy.
- Forward Collision-Avoidance Assist may turn off or may not operate properly or may operate unnecessarily depending on the road conditions and the surroundings.
- Even if there is a problem with Forward Collision-Avoidance Assist, the vehicle's basic braking performance will operate normally.
- During emergency braking, braking control by Forward Collision-Avoid-

ance Assist will automatically cancel when the driver excessively depresses the accelerator pedal or sharply steers the vehicle.

⚠ CAUTION

Depending on the condition of the vehicle, pedestrian and cyclist in front and the surroundings, the speed range to operate Forward Collision-Avoidance Assist may reduce. Forward Collision-Avoidance Assist may only warn the driver, or it may not operate.

* NOTICE

- When a collision is imminent, the Forward Collision-Avoidance Assist may assist the driver with brakes if the driver fails to brake enough.
- The images or colours may be displayed differently depending on the specifications of the instrument cluster or theme.

Forward Collision-Avoidance Assist malfunction and limitations

Forward Collision-Avoidance Assist malfunction

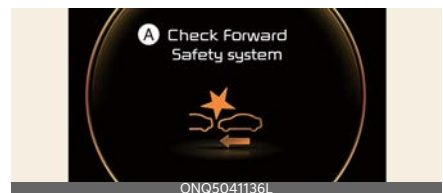

A: Check Forward Safety system

When Forward Collision-Avoidance Assist is not working properly, the warning message will appear, and the (⚠) and (⚠) warning lights will appear on the cluster.

Forward Collision-Avoidance Assist disabled

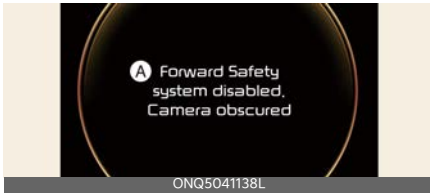

A: Forward safety system disabled. Camera obscured

When the front windscreen where the front view camera is located is covered with foreign material, such as snow or rain, it can reduce the detecting performance and temporarily limit or disable Forward Collision-Avoidance Assist.

If this occurs the warning message, and the (⚠) and (A) warning lights will appear on the cluster. Forward Collision-Avoidance Assist will operate normally when snow, rain or foreign material is removed. Always keep it clean.

If Forward Collision-Avoidance Assist does not operate normally after obstruction (snow, rain, or foreign material) is removed, have the vehicle inspected by a professional workshop. Kia recommends visiting an authorised Kia dealer/service partner.

⚠ WARNING

- Even though the warning message or warning light does not appear on the cluster, Forward Collision-Avoidance Assist may not properly operate.
- Forward Collision-Avoidance Assist may not properly operate in an area (e.g. open terrain), where any substance are not detected after turning ON the vehicle.

Limitations of Forward Collision-Avoidance Assist

Forward Collision-Avoidance Assist may not operate normally, or it may operate unexpectedly under the following circumstances:

- The detecting sensor or the surroundings are contaminated or damaged
- The temperature around the front view camera is high or low due to surrounding environment
- The camera lens is contaminated due to tinted, filmed or coated windscreen, damaged glass, or sticky foreign material (sticker, bug, etc.) on the glass
- Moisture is not removed or frozen on the windscreen
- Washer fluid is continuously sprayed, or the wiper is on
- Driving in heavy rain or snow, or thick fog
- The field of view of the front view camera is obstructed by sun glare
- Street light or light from an oncoming vehicle is reflected on the wet road surface, such as a puddle on the road
- An object is placed on the instrument panel
- Your vehicle is being towed
- The surroundings are very bright
- The surroundings are very dark, such as in a tunnel, etc.
- The brightness changes suddenly, for example when entering or exiting a tunnel
- The brightness outside is low, and the headlamps are not on or are not bright
- Only part of the vehicle, pedestrian or cyclist is detected

- The vehicle in front is a bus, heavy truck, truck with a unusually shaped luggage, trailer, etc.
- The vehicle in front has no tail lights, tail lights are located unusually, etc.
- The brightness outside is low, and the tail lamps are not on or are not bright
- The rear of the front vehicle is small or the vehicle does not look normal, such as when the vehicle is tilted, overturned, or the side of the vehicle is visible, etc.
- The front vehicle's ground clearance is low or high
- A vehicle, pedestrian or cyclist suddenly cuts in front
- The vehicle in front is detected late
- The vehicle in front is suddenly blocked by an obstacle
- The vehicle in front suddenly changes lane or suddenly reduces speed
- The vehicle in front is bent out of shape
- The front vehicle's speed is fast or slow
- The vehicle in front steers in the opposite direction of your vehicle to avoid a collision
- With a vehicle in front, your vehicle changes lane at low speed
- The vehicle in front is covered with snow
- You are departing or returning to the lane
- Unstable driving
- You are on a roundabout and the vehicle in front is not detected
- You are continuously driving in a circle
- The vehicle in front has an unusual shape

- The vehicle in front is driving uphill or downhill
- The pedestrian or cyclist is not fully detected, for example, if the pedestrian is leaning over or is not fully walking upright
- The pedestrian or cyclist is wearing clothing or equipment that makes it difficult to detect as a pedestrian or cyclist

The illustration below shows the image the front view camera will detect as a vehicle, pedestrian and cyclist.



- The pedestrian or cyclist in front is moving very quickly
- The pedestrian or cyclist in front is short or is posing a low posture
- The pedestrian or cyclist in front has impaired mobility
- The pedestrian or cyclist in front is moving intersected with the driving direction
- There is a group of pedestrians, cyclists or a large crowd in front
- The pedestrian or cyclist is wearing clothing that easily blends into the background, making it difficult to detect
- The pedestrian or cyclist is difficult to distinguish from the similar shaped structure in the surroundings
- You are driving by a pedestrian, cyclist, traffic signs, structures, etc. near the intersection
- When driving in the following places

- Driving through steam, smoke or shadow
- Driving through a tunnel or iron bridge
- Driving in large areas where there are few vehicles or structures (i.e. desert, meadow, suburb, etc.)
- Driving in a parking lot
- Driving near areas containing metal substances, such as a construction zone, railroad, etc.
- Driving on an incline road, curved road, etc.
- Driving through a roadside with trees or streetlights
- Driving through a narrow road where trees or grass are overgrown
- There is interference by electromagnetic waves, such as driving in an area with strong radio waves or electrical noise
- The adverse road conditions cause excessive vehicle vibrations whilst driving
- Your vehicle height is low or high due to heavy loads, abnormal tyre pressure, etc.

⚠ WARNING

- Driving on a curved road



Forward Collision-Avoidance Assist may not detect other vehicle, pedestrian or cyclist in front of you on curved roads adversely affecting the performance of the sensors. This may

result in no warning or braking assist when necessary.

When driving on a curved road, you must maintain a safe braking distance, and if necessary, steer the vehicle and depress the brake pedal to reduce your driving speed in order to maintain a safe distance.



Forward Collision-Avoidance Assist may detect a vehicle, pedestrian or cyclist in the next lane or outside the lane when driving on a curved road.

If this occurs, Forward Collision-Avoidance Assist may unnecessarily warn the driver and control the brake or steering wheel (if equipped). Always check the traffic conditions around the vehicle.

- Driving on an inclined road



Forward Collision-Avoidance Assist may not detect other vehicle, pedestrian or cyclist in front of you whilst driving uphill or downhill, adversely affecting the performance of the sensors.

This may result in unnecessary warning or braking assist or no warning or braking assist when necessary.

Also, vehicle speed may rapidly decrease when a vehicle, pedestrian or cyclist ahead is suddenly detected. Always have your eyes on the road whilst driving uphill or downhill and if necessary, steer your vehicle and depress the brake pedal to reduce your driving speed in order to maintain a safe distance.

- Changing lanes

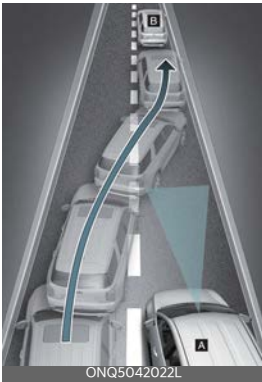

[A]: Your vehicle, [B]: Lane changing vehicle

When a vehicle (B) moves into your lane from an adjacent lane, it cannot be detected by the sensor until it is in the sensor's detection range. Forward Collision-Avoidance Assist may not immediately detect the vehicle when the vehicle changes lanes abruptly. In this case, you must maintain a safe braking distance, and if necessary, steer your vehicle and depress the brake pedal to reduce your driving speed in order to maintain a safe distance.

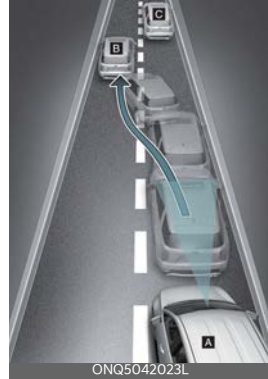

[A]: Your vehicle, [B]: Lane changing vehicle,

[C]: Same lane vehicle

When a vehicle (B) in front of you merges out of the lane, Forward Collision-Avoidance Assist may not immediately detect the vehicle (C) that is now in front of you. In this case, you must maintain a safe braking distance, and if necessary, steer your vehicle and depress the brake pedal to reduce your driving speed in order to maintain a safe distance.

- Detecting a vehicle



If the vehicle in front of you has cargo that extends rearward from the cab, or when the vehicle in front of you has higher ground clearance, additional

special attention is required. Forward Collision-Avoidance Assist may not be able to detect the cargo extending from the vehicle. In these instances, you must maintain a safe braking distance from the rearmost object, and if necessary, steer your vehicle and depress the brake pedal to reduce your driving speed in order to maintain distance.

⚠ WARNING

- When you are towing a trailer or another vehicle, we recommend that Forward Collision-Avoidance Assist is turned off due to safety reasons.
- Forward Collision-Avoidance Assist may operate if objects that are similar in shape or characteristics to vehicle, pedestrian or cyclist are detected.
- Forward Collision-Avoidance Assist does not operate on bicycles, motorcycles, or smaller wheeled objects, such as luggage bags, shopping carts, or strollers.
- Forward Collision-Avoidance Assist may not operate normally if interfered by strong electromagnetic waves.
- Forward Collision-Avoidance Assist may not operate for 15 seconds after the vehicle is started, or the front view camera is initialized.

Forward Collision-Avoidance Assist (FCA) (Sensor Fusion) (if equipped)

Basic function

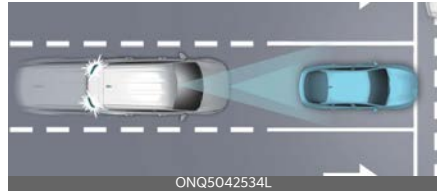

Forward Collision-Avoidance Assist is designed to help detect and monitor the vehicle ahead or help detect a pedestrian or cyclist in the roadway and warn the driver that a collision is imminent with a warning message and an audible warning, apply emergency braking.

Junction Turning function

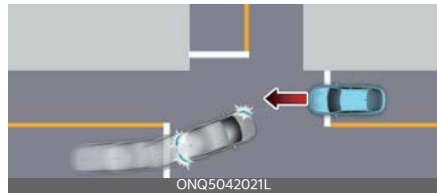

Junction Turning function will help avoid a collision with an oncoming vehicle in an adjacent lane when turning left (left-hand drive) or right (right-hand drive) at a crossroad with the turn signal on by applying emergency braking.

Detecting sensor

Front view camera



Front radar



Refer to the picture above for the detailed location of the detecting sensors.

CAUTION

- Never disassemble the detecting sensor or sensor assembly, or apply any impact on it.
 - If the detecting sensors have been replaced or repaired, have the vehicle inspected by a professional workshop. Kia recommends visiting an authorised Kia dealer/service partner.
 - Never install any accessories or stickers on the front windscreen, or tint the front windscreen.
 - Pay extreme caution to keep the front view camera dry.
 - Never place any reflective objects (i.e. white paper, mirror) over the instrument panel.
 - Do not apply license plate frame or objects, such as a bumper sticker, film or a bumper guard, near the front radar cover.
- Always keep the front radar and cover clean and free of dirt and debris. Use only a soft cloth to wash the vehicle. Do not spray pressurized water directly on the sensor or sensor cover.
 - If unnecessary force has been applied to the radar or around the radar, Forward Collision-Avoidance Assist may not properly operate even though a warning message does not appear on the cluster. Have the vehicle inspected by a professional workshop. Kia recommends visiting an authorised Kia dealer/service partner.
 - The genuine Kia front radar sensor covers are parts with quality and performance ensured. If arbitrarily applying paint on or changing the cover, Forward Collision-Avoidance Assist may not function properly. Use only Kia Genuine Parts or those of an equivalent standard with proven quality and performance to repair or replace the radar sensor covers.
 - Do not place any objects near the front windscreen or install any accessories on the front windscreen. It can affect the performance of the defogging and defrosting function of the climate control system, which may prevent the Driver Assistance systems from operating.

Forward Collision-Avoidance Assist settings

Forward Safety



A: Driver assistance

- 1 Forward safety
- 2 Active Assist
- 3 Warning Only
- 4 Off

With the vehicle on, select **Driver assistance** → **Forward safety** from the Settings menu to set whether or not to use each function.

- **Active Assist:** Forward Collision-Avoidance Assist will warn the driver with a warning message, an audible warning and steering wheel vibration (if equipped) depending on the collision risk levels. Braking assist or steering assist (if equipped) will be applied depending on the collision risk.
- **Warning Only:** Forward Collision-Avoidance Assist will warn the driver with a warning message, an audible warning and steering wheel vibration (if equipped) depending on the collision risk levels. Braking and steering (if equipped) will not be assisted. The

driver must apply the brake pedal or steer the vehicle if necessary.

- **Off:** Forward Collision-Avoidance Assist will turn off. The warning light (🚨) will appear on the cluster.

The driver can monitor Forward Collision-Avoidance Assist ON/OFF status from the Settings menu. If the warning light (🚨) remains ON when Forward Collision-Avoidance Assist is ON, have the vehicle inspected by a professional workshop. Kia recommends visiting an authorised Kia dealer/service partner.

⚠ WARNING

When the vehicle is restarted, Forward Collision-Avoidance Assist will always turn on. However, if **Off** is selected, the driver should always be aware of the surroundings and drive safely.

⚠ CAUTION

- If **Warning only** is selected, braking and steering (if equipped) is not assisted.
- The settings for Forward Safety include 'Basic function' and 'Junction Turning'.
- Steering wheel vibration (if equipped) can be turned on or off. Select or deselect **Driver assistance** → **Haptic warning** from the Settings menu.

* NOTICE

Forward Collision-Avoidance Assist will turn off when ESC is turned off by pressing and holding the ESC OFF button. The warning light (🚨) will appear on the cluster.

Warning timing



A: Driver assistance

1 Warning timing

2 Normal

3 Late

With the vehicle on, select **Driver assistance** → **Warning timing** from the Settings menu to change the initial warning activation time for Forward Collision-Avoidance Assist.

- **Normal:** Use in a normal driving environment. If the function operates too sensitively, set to the warning timing to **Late**.
- **Late:** The warning timing will be slow.

Warning methods

Type A

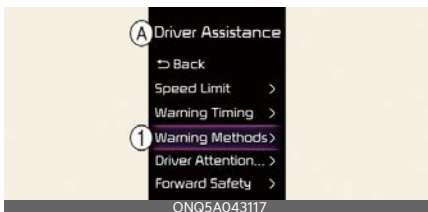

Type B

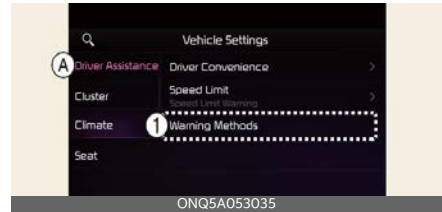

A: Driver Assistance

1 Warning Methods

The Warning Methods can be set with the vehicle on. Select **User Settings** → **Driver Assistance** → **Warning Methods** from the settings menu in the instrument cluster or **Settings** → **Vehicle** → **Driver Assistance** → **Warning Methods** from the settings menu in the infotainment system to change the following settings:

- **Warning Volume:** Adjusts the volume of the warning sound.
- **Haptic Warning:** Activate the steering wheel vibration warning. (if equipped)
- **Driving Safety Priority:** Lowers all other audio volumes when the Driving Safety system sounds a warning.

* INFORMATION

- If you change the Warning Methods, it can be applied to each function of the driver assistance system. Please check and change it in each function.
- If the vehicle is restarted, Warning Methods will maintain the last setting.
- The setting menu may not exist based on vehicle specification.
- The **Warning Volume** and **Haptic Warning** cannot be turned off at the same time. When one of the warning is turned off the other is activated.

Forward Collision-Avoidance Assist operation

Warning and control

The basic function for Forward Collision-Avoidance Assist is warned and controlled by the following level.

- Collision Warning
- Emergency Braking
- Stopping vehicle and ending brake control

Collision Warning



A: Collision Warning

The warning message, an audible warning and the steering wheel will vibrate (if equipped) to warn the driver of a collision. If **Active Assist** is selected, braking may be assisted.

Collision Warning will be activated in the following your vehicle speed conditions, depending on the target ahead and the collision risk level when:

- A vehicle is detected and your vehicle speed is approximately 5~180 km/h (3~112 mph).
- A pedestrian or cyclist is detected and your vehicle speed is approximately 5~85 km/h (3~53 mph).

Emergency braking



A: Emergency braking

The warning message, an audible warning and the steering wheel will vibrate (if equipped) to warn the driver that emergency braking will be assisted. The brake assist will be activated and it helps avoiding collision of a vehicle, pedestrian and cyclist.

Emergency Braking will be activated in the following your vehicle speed conditions, depending on the target ahead and the collision risk level when:

- A vehicle is detected and your vehicle speed is approximately 5~85 km/h (3~53 mph).
- A pedestrian or cyclist is detected and your vehicle speed is approximately 5~65 km/h (3~40 mph).

Stopping vehicle and ending brake control



A: Drive carefully

When the vehicle is stopped due to emergency braking, the warning message will appear on the cluster.

For your safety, the driver should depress the brake pedal immediately and check the surroundings.

- Brake control will end after the vehicle is stopped by emergency braking for approximately 2 seconds.

Junction Turning function

Warning and control

The basic function for Junction Turning function is warned and controlled by the following level.

- Collision Warning
- Emergency Braking
- Stopping vehicle and ending brake control

Collision Warning



A: Collision Warning

The warning message, an audible warning and the steering wheel will vibrate (if equipped) to warn the driver of a collision. If **Active Assist** is selected, braking may be assisted.

Collision Warning will be activated in following conditions.

Your vehicle speed is approximately 7~30 km/h (4~19 mph) and oncoming vehicle speed is approximately 25~70 km/h (15~44 mph)

Emergency braking



A: Emergency braking

The warning message, an audible warning and the steering wheel will vibrate (if equipped) to warn the driver that emergency braking will be assisted. The brake assist will be activated and it helps avoiding collision of a vehicle.

Emergency Braking will be activated in following conditions.

Your vehicle speed is approximately 7~30 km/h (4~19 mph) and oncoming vehicle speed is approximately 25~70 km/h (15~44 mph)

Stopping vehicle and ending brake control



A: Drive carefully

When the vehicle is stopped due to emergency braking, the warning message will appear on the cluster.

For your safety, the driver should depress the brake pedal immediately and check the surroundings.

- Brake control will end after the vehicle is stopped by emergency braking for approximately 2 seconds.

⚠ CAUTION

If the driver's seat is on the left side, Junction Turning function will operate only when the driver turns left. If the driver's seat position is on right side, the function will operate only when you turn right.

WARNING

- For your safety, change the Settings after parking the vehicle at a safe location.
- With **Active Assist** or **Warning only** selected, when ESC is turned off by pressing and holding the ESC OFF button, Forward Collision-Avoidance Assist will turn off automatically. In this case, Forward Collision-Avoidance Assist cannot be set from the Settings menu and the  warning light will appear on the cluster which is normal. If ESC is turned on by pressing the ESC OFF button again, Forward Collision-Avoidance Assist will maintain the last setting.
- Forward Collision-Avoidance Assist does not operate in all situations or cannot avoid all collisions.
- The driver should hold the responsibility to control the vehicle. Do not solely depend on Forward Collision-Avoidance Assist. Rather, maintain a safe braking distance, and if necessary, depress the brake pedal to reduce driving speed or to stop the vehicle.
- Never deliberately operate Forward Collision-Avoidance Assist on people, objects, etc. It may cause serious injury or death.
- Forward Collision-Avoidance Assist may not operate if the driver depresses the brake pedal to avoid collision.
- Depending on the road and driving conditions, Forward Collision-Avoidance Assist may warn the driver late or may not warn the driver.
- During Forward Collision-Avoidance Assist operation, the vehicle may stop suddenly injuring passengers and

shifting loose objects. Always have the seat belt on and keep loose objects secured.

- If any other function's warning message is displayed or audible warning is generated, Forward Collision-Avoidance Assist warning message may not be displayed and audible warning may not be generated.
- You may not hear the warning sound of Forward Collision-Avoidance Assist if the surroundings are noisy.
- Forward Collision-Avoidance Assist may turn off or may not operate properly or may operate unnecessarily depending on the road conditions and the surroundings.
- Even if there is a problem with Forward Collision-Avoidance Assist, the vehicle's basic braking performance will operate normally.
- During emergency braking, braking control by Forward Collision-Avoidance Assist will automatically cancel when the driver excessively depresses the accelerator pedal or sharply steers the vehicle.

CAUTION

- Depending on the condition of the vehicle, pedestrian and cyclist in front and the surroundings, the speed range to operate Forward Collision-Avoidance Assist may reduce. Forward Collision-Avoidance Assist may only warn the driver, or it may not operate.
- Forward Collision-Avoidance Assist will operate under certain conditions by judging the risk level based on the condition of the oncoming vehicle,

driving direction, speed and surroundings.

*** NOTICE**

- In a situation where collision is imminent, braking may be assisted by Forward Collision-Avoidance Assist when braking is insufficient by the driver.
- The images or colours may be displayed differently depending on the specifications of the instrument cluster or theme.

Forward Collision-Avoidance Assist malfunction and limitations

Forward Collision-Avoidance Assist malfunction



A: Check Forward Safety system

When Forward Collision-Avoidance Assist is not working properly, the warning message will appear, and the (🚨) and (⚠️) warning lights will appear on the cluster.

Forward Collision-Avoidance Assist disabled

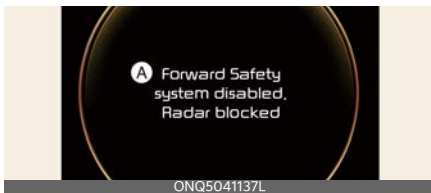

A: Forward safety system disabled. Radar blocked



A: Forward safety system disabled. Camera obscured

When the front windscreen where the front view camera is located, front radar cover, or sensor is located is covered with foreign material, such as snow or rain, it can reduce the detecting performance and temporarily limit or disable Forward Collision-Avoidance Assist.

If this occurs the warning message, and the (🚨) and (⚠️) warning lights will appear on the cluster.

Forward Collision-Avoidance Assist will operate normally when snow, rain or foreign material is removed. Always keep it clean.

If Forward Collision-Avoidance Assist does not operate normally after obstruction (snow, rain, or foreign material) is removed, have the vehicle inspected by a professional workshop. Kia recommends visiting an authorised Kia dealer/ service partner.

⚠️ WARNING

- Even though the warning message or warning light does not appear on the cluster, Forward Collision-Avoidance Assist may not properly operate.
- Forward Collision-Avoidance Assist may not properly operate in an area (e.g. open terrain), where any substance are not detected after turning ON the vehicle.

Limitations of Forward Collision-Avoidance Assist

Forward Collision-Avoidance Assist may not operate normally, or it may operate unexpectedly under the following circumstances:

- The detecting sensor or the surroundings are contaminated or damaged
- The temperature around the front view camera is high or low due to surrounding environment
- The camera lens is contaminated due to tinted, filmed or coated windscreen, damaged glass, or sticky foreign material (sticker, bug, etc.) on the glass
- Moisture is not removed or frozen on the windscreen
- Washer fluid is continuously sprayed, or the wiper is on
- Driving in heavy rain or snow, or thick fog
- The field of view of the front view camera is obstructed by sun glare
- Street light or light from an oncoming vehicle is reflected on the wet road surface, such as a puddle on the road
- An object is placed on the instrument panel
- Your vehicle is being towed
- The surroundings are very bright
- The surroundings are very dark, such as in a tunnel, etc.
- The brightness changes suddenly, for example when entering or exiting a tunnel
- The brightness outside is low, and the headlamps are not on or are not bright
- Only part of the vehicle, pedestrian or cyclist is detected
- The vehicle in front is a bus, heavy truck, truck with a unusually shaped luggage, trailer, etc.
- The vehicle in front has no tail lights, tail lights are located unusually, etc.
- The brightness outside is low, and the tail lamps are not on or are not bright
- The rear of the front vehicle is small or the vehicle does not look normal, such as when the vehicle is tilted, overturned, or the side of the vehicle is visible, etc.
- The front vehicle's ground clearance is low or high
- A vehicle, pedestrian or cyclist suddenly cuts in front
- The bumper around the front radar is impacted, damaged or the front radar is out of position
- The temperature around the front radar is high or low
- Driving through a tunnel or iron bridge
- Driving in large areas where there are few vehicles or structures (i.e. desert, meadow, suburb, etc.)
- Driving near areas containing metal substances, such as a construction zone, railroad, etc.
- A material is near that reflects very well on the front radar, such as a guardrail, nearby vehicle, etc.
- The cyclist in front is on a bicycle made of material that does not reflect on the front radar
- The vehicle in front is detected late
- The vehicle in front is suddenly blocked by an obstacle
- The vehicle in front suddenly changes lane or suddenly reduces speed
- The vehicle in front is bent out of shape

- The front vehicle's speed is fast or slow
- The vehicle in front steers in the opposite direction of your vehicle to avoid a collision
- With a vehicle in front, your vehicle changes lane at low speed
- The vehicle in front is covered with snow
- You are departing or returning to the lane
- Unstable driving
- You are on a roundabout and the vehicle in front is not detected
- You are continuously driving in a circle
- The vehicle in front has an unusual shape
- The vehicle in front is driving uphill or downhill
- The pedestrian or cyclist is not fully detected, for example, if the pedestrian is leaning over or is not fully walking upright
- The pedestrian or cyclist is wearing clothing or equipment that makes it difficult to detect as a pedestrian or cyclist
- The pedestrian or cyclist in front is short or is posing a low posture
- The pedestrian or cyclist in front has impaired mobility
- The pedestrian or cyclist in front is moving intersected with the driving direction
- There is a group of pedestrians, cyclists or a large crowd in front
- The pedestrian or cyclist is wearing clothing that easily blends into the background, making it difficult to detect
- The pedestrian or cyclist is difficult to distinguish from the similar shaped structure in the surroundings
- You are driving by a pedestrian, cyclist, traffic signs, structures, etc. near the intersection
- When driving in the following places
 - Driving through steam, smoke or shadow
 - Driving through a tunnel or iron bridge
 - Driving in large areas where there are few vehicles or structures (i.e. desert, meadow, suburb, etc.)
 - Driving in a parking lot
 - Driving through toll gate, construction areas, partially paved roads, bumpy roads, speed bumps, etc.
 - Driving near areas containing metal substances, such as a construction zone, railroad, etc.
 - Driving on an incline road, curved road, etc.
 - Driving through a roadside with trees or streetlights
 - Driving through a narrow road where trees or grass are overgrown

The illustration below shows the image the front view camera and front radar will detect as a vehicle, pedestrian and cyclist.



- The pedestrian or cyclist in front is moving very quickly

- There is interference by electromagnetic waves, such as driving in an area with strong radio waves or electrical noise
- The adverse road conditions cause excessive vehicle vibrations whilst driving
- Your vehicle height is low or high due to heavy loads, abnormal tyre pressure, etc.

⚠ WARNING

- Driving on a curved road



Forward Collision-Avoidance Assist may not detect other vehicle, pedestrian or cyclist in front of you on curved roads adversely affecting the performance of the sensors. This may result in no warning or braking assist when necessary.

When driving on a curved road, you must maintain a safe braking distance, and if necessary, steer the vehicle and depress the brake pedal to reduce your driving speed in order to maintain a safe distance.



Forward Collision-Avoidance Assist may detect a vehicle, pedestrian or cyclist in the next lane or outside the lane when driving on a curved road.

If this occurs, Forward Collision-Avoidance Assist may unnecessarily warn the driver and control the brake or steering wheel (if equipped). Always check the traffic conditions around the vehicle.

- Driving on an inclined road



Forward Collision-Avoidance Assist may not detect other vehicle, pedestrian or cyclist in front of you whilst driving uphill or downhill, adversely affecting the performance of the sensors.

This may result in unnecessary warning or braking assist or no warning or braking assist when necessary.

Also, vehicle speed may rapidly decrease when a vehicle, pedestrian or cyclist ahead is suddenly detected. Always have your eyes on the road whilst driving uphill or downhill and if necessary, steer your vehicle and depress the brake pedal to reduce your driving speed in order to maintain a safe distance.

- Changing lanes

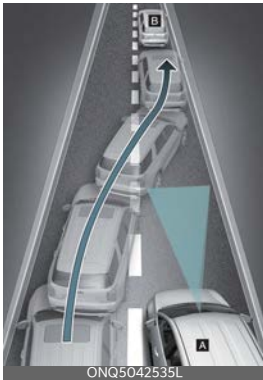

[A]: Your vehicle, [B]: Lane changing vehicle

When a vehicle (B) moves into your lane from an adjacent lane, it cannot be detected by the sensor until it is in the sensor's detection range. Forward Collision-Avoidance Assist may not immediately detect the vehicle when the vehicle changes lanes abruptly. In this case, you must maintain a safe braking distance, and if necessary, steer your vehicle and depress the brake pedal to reduce your driving speed in order to maintain a safe distance.

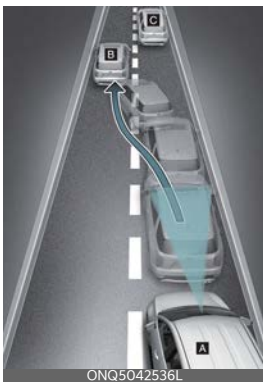

ONQ5042536L

[A]: Your vehicle, [B]: Lane changing vehicle,

[C]: Same lane vehicle

When a vehicle (B) in front of you merges out of the lane, Forward Collision-Avoidance Assist may not immediately detect the vehicle (C) that is now in front of you. In this case, you must maintain a safe braking distance, and if necessary, steer your vehicle and depress the brake pedal to reduce your driving speed in order to maintain a safe distance.

- Detecting a vehicle



ONQ5041024_2

If the vehicle in front of you has cargo that extends rearward from the cab, or when the vehicle in front of you has higher ground clearance, additional special attention is required. Forward Collision-Avoidance Assist may not be able to detect the cargo extending from the vehicle. In these instances, you must maintain a safe braking distance from the rearmost object, and if necessary, steer your vehicle and depress the brake pedal to reduce your driving speed in order to maintain distance.

⚠ WARNING

- When you are towing a trailer or another vehicle, we recommend that Forward Collision-Avoidance Assist is turned off due to safety reasons.
- Forward Collision-Avoidance Assist may operate if objects that are similar in shape or characteristics to vehicle, pedestrian or cyclist are detected.
- Forward Collision-Avoidance Assist does not operate on bicycles, motor-cycles, or smaller wheeled objects, such as luggage bags, shopping carts, or strollers.
- Forward Collision-Avoidance Assist may not operate normally if interfered by strong electromagnetic waves.
- Forward Collision-Avoidance Assist may not operate for 15 seconds after the vehicle is started, or the front view camera is initialized.

Lane Keeping Assist (LKA) (if equipped)

Lane Keeping Assist is designed to help detect lane markings (or road edges) whilst driving over a certain speed. Lane Keeping Assist will warn the driver if the vehicle leaves the lane without using the turn signal, or will automatically assist the driver's steering to help prevent the vehicle from departing the lane.

Detecting sensor

Front view camera



The front view camera is used as a detecting sensor to detect lane markings (or road edges).

Refer to the picture above for the detailed location of the detecting sensor.

⚠ CAUTION

For more details on the precautions of the front view camera, refer to "Forward Collision-Avoidance Assist (FCA) (Front Camera Only) (if equipped)" on page 7-5.

Lane Keeping Assist settings

Lane safety



A: Driver assistance

1 Lane safety

2 Assist

3 Warning only

4 Off

With the vehicle on, select or deselect **Driver assistance** → **Lane safety** from the Settings menu to set whether or not to use each function.

- **Assist:** Lane Keeping Assist will automatically assist the driver's steering when lane departure is detected to help prevent the vehicle from moving out of its lane.
- **Warning only:** Lane Keeping Assist will warn the driver with an audible warning and steering wheel vibration (if equipped) when lane departure is detected. The driver must steer the vehicle.
- **Off:** Lane Keeping Assist will turn off. The indicator (🚗) light will turn off on the cluster.

⚠️ WARNING

- If **Warning only** is selected, steering is not assisted.

- Lane Keeping Assist does not control the steering wheel when the vehicle is driven in the middle of the lane.
- The driver should always be aware of the surroundings and steer the vehicle if **Off** is selected.

Turning Lane Keeping Assist On/Off



Except Europe, Australia, Russia

With the vehicle on, press and hold the Lane Driving Assist button located on the steering wheel to turn on Lane Keeping Assist. The grey or green (🚗) indicator light will appear on the cluster.

Press and hold the button again to turn off the function.

If the vehicle is restarted, Lane Keeping Assist will maintain the last setting.

For Europe, Australia, Russia

Whenever the vehicle is turned on, Lane Keeping Assist will always turn on. The grey (🚗) indicator light will appear on the cluster.

When Lane Keeping Assist is on, press and hold the Lane Driving Assist button to turn off the function.

* NOTICE

When Lane Keeping Assist is turned off with the Lane Driving Assist button, the Lane Safety setting also changes to **Off**.

Warning methods

Type A

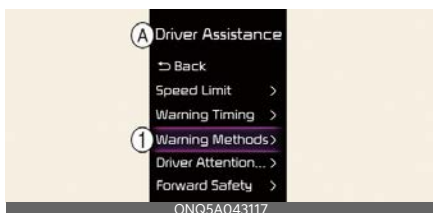

Type B

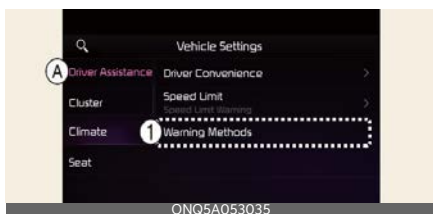

A: Driver Assistance

1 Warning Methods

The Warning Methods can be set with the vehicle on. Select **User Settings** → **Driver Assistance** → **Warning Methods** from the settings menu in the instrument cluster or **Settings** → **Vehicle** → **Driver Assistance** → **Warning Methods** from the settings menu in the infotainment system to change the following settings:

- **Warning Volume:** Adjusts the volume of the warning sound.
- **Haptic Warning:** Activate the steering wheel vibration warning. (if equipped)
- **Lane Safety Audible Warning Off:** Turns off the Lane Safety Audible Warning, even when both warning volume and haptic warning are on. (if equipped)
- **Driving Safety Priority:** Lowers all other audio volumes when the Driving Safety system sounds a warning.

* INFORMATION

- If you change the Warning Methods, it can be applied to each function of the driver assistance system. Please check and change it in each function.
- If the vehicle is restarted, Warning Methods will maintain the last setting.
- The setting menu may not exist based on vehicle specification.
- The **Warning Volume** and **Haptic Warning** cannot be turned off at the same time. When one of the warning is turned off the other is activated.
- The **Lane Safety Audible Warning Off** can be set when both the Warning Volume and the Haptic Warning are on.

Lane Keeping Assist operation

Warning and control

Left



Right



Lane Keeping Assist will warn and control the vehicle with Lane Departure Warning and Lane Keeping Assist.

Lane Departure Warning

- To warn the driver that the vehicle is departing from the projected lane in front, the green (🚗) indicator light will blink on the cluster, the lane line will blink on the cluster depending on which direction the vehicle is steering, and an audible warning will sound. Also, the steering wheel will vibrate (if equipped).
- Vehicle speed: Approximately 60~200 km/h (40~120 mph).

Lane Keeping Assist

- To warn the driver that the vehicle is departing from the projected lane in front, the green (🚗) indicator light will blink on the cluster, and the steering wheel will make adjustments to keep vehicle inside the lane.
- Vehicle speed: Approximately 60~200 km/h (40~120 mph).

Hands-off warning

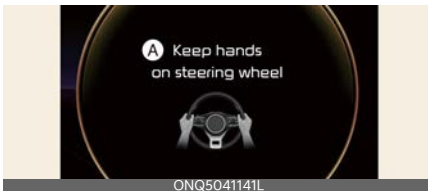

A: Keep hands on steering wheel

If the driver takes their hands off the steering wheel for several seconds, the warning message will appear on the cluster, and an audible warning will sound in stages.

⚠ WARNING

- The steering wheel may not be assisted if the steering wheel is held

very tight or the steering wheel is steered over a certain degree.

- Lane Keeping Assist does not operate at all times. It is the responsibility of the driver to safely steer the vehicle and to maintain the vehicle in its lane.
- The hands-off warning message may appear late depending on road conditions. Always have your hands on the steering wheel whilst driving.
- If the steering wheel is held very lightly, the hands-off warning message may appear because Lane Keeping Assist may not detect that the driver has their hands on the steering wheel.
- If you attach objects to the steering wheel, the hands-off warning may not work properly.

* NOTICE

- For more details on setting the instrument cluster, refer to "Instrument cluster" on page 4-41.
- When lane markings (or road edges) are detected, the lane lines on the cluster will change from gray to white and the green (🚗) indicator light will appear.

Lane undetected



Lane detected



- Even though the steering is assisted by Lane Keeping Assist, the driver may control the steering wheel.
- The steering wheel may feel heavier or lighter when the steering wheel is assisted by Lane Keeping Assist than when it is not.

*** NOTICE**

The images or colours may be displayed differently depending on the specifications of the instrument cluster or theme.

Lane Keeping Assist malfunction and limitations

Lane Keeping Assist malfunction

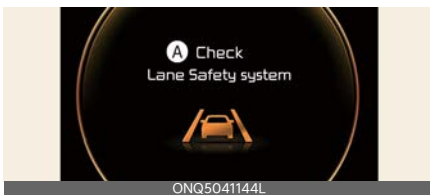

A: Check Lane Safety system

When Lane Keeping Assist is not working properly, the warning message will appear and the yellow (🚗) indicator light will appear on the cluster. If this occurs, have the function inspected by a professional workshop. Kia recommends visiting an authorised Kia dealer/service partner.

Limitations of Lane Keeping Assist

Lane Keeping Assist may not operate normally or may operate unexpectedly under the following circumstances:

- The lane is contaminated or difficult to distinguish because,
 - The lane markings (or road edge) is covered with rain, snow, dirt, sand, oil, puddle etc.
 - The colour of the lane marking (or road edge) is not distinguishable from the road
 - There are markings (or road edges) on the road near the lane or the markings (or road edges) on the road looks similar to the lane markings (or road edges)
 - The lane marking (or road edge) is indistinct or damaged
 - The shadow is on the lane marking (or road edge) by a median strip, trees, guardrail, noise barriers, etc.
- The number of lanes increases or decreases, or the lane markings are crossing
- There are more than two lane markings (or road edges) on the road
- The lane markings (or road edges) are complicated or a structure substitutes for the lines, such as a construction area
- There are road markings, such as zig-zag lanes, crosswalk markings and road signs
- The lane suddenly disappears, such as at the intersection
- The lane (or road width) is very wide or narrow
- There is a road edge without a lane

- There is a boundary structure in the roadway, such as a tollgate, sidewalk, kerb, etc.
- The distance to the front vehicle is extremely short or the vehicle in front is covering the lane marking (or road edge)

* NOTICE

For more details on the limitations of the front view camera, refer to "Forward Collision-Avoidance Assist (FCA) (Front Camera Only) (if equipped)" on page 7-5.

⚠ WARNING

Take the following precautions when using Lane Keeping Assist:

- The driver should hold the responsibility to safely drive and control the vehicle. Do not solely rely on the function and drive dangerously.
- The operation of Lane Keeping Assist can be cancelled or not work properly depending on road conditions and surroundings. Always be cautious whilst driving.
- Refer to "Limitations of Lane Keeping Assist" if the lane is not detected properly.
- When you are towing a trailer or another vehicle, we recommend that Lane Keeping Assist is turned off due to safety reasons.
- If the vehicle is driven at high speed, the steering wheel will not be controlled. The driver must always follow the speed limit when using Lane Keeping Assist.
- If any other function's warning message is displayed or audible warning is generated, Lane Keeping Assist warning message may not be displayed and audible warning may not be generated.
- You may not hear the warning sound of Lane Keeping Assist if the surroundings are noisy.
- If you attach objects to the steering wheel, steering may not be assisted properly.
- Lane Keeping Assist may not operate for 15 seconds after the vehicle is started, or the Front view camera is initialized.
- Lane Keeping Assist will not operate when:
 - The turn signal or hazard warning flasher is turned on
 - The vehicle is not driven in the centre of the lane when the function is turned on or right after changing a lane
 - ESC (Electronic Stability Control) or VSM (Vehicle Stability Management) is activated
 - The vehicle is driven on a sharp curved road
 - Vehicle speed is below 55 km/h (35 mph) or above 210 km/h (130 mph)
 - The vehicle makes sharp lane changes
 - The vehicle brakes suddenly

Blind-Spot Collision Warning (BCW) (if equipped)

Blind-Spot Collision Warning is designed to help detect and monitor approaching vehicles in the driver's blind spot area and warn the driver of a possible collision with a warning message and audible warning.

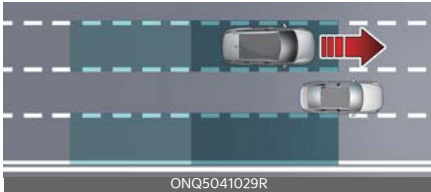

Blind-Spot Collision Warning helps detect and inform the driver that a vehicle is in the blind spot.

CAUTION

The detecting range may vary depending on the speed of your vehicle. However, even if there is a vehicle in the blind spot area, the function may not warn you when you pass by at high speeds.

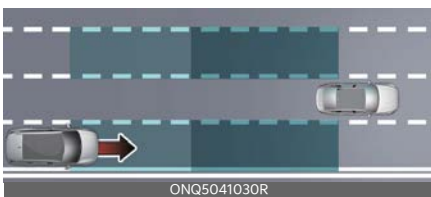

Blind-Spot Collision Warning helps detect and informs the driver that a vehicle is approaching at high speed from the blind spot area.

CAUTION

Warning timing may vary depending on the speed of the vehicle approaching at high speed.

Detecting sensor

Rear corner radar



Refer to the picture above for the detailed location of the detecting sensors.

CAUTION

- Never disassemble the rear corner radar or radar assembly, or apply any impact on it.
- If there is impact on the rear corner radar or near the radar, even though the warning message does not appear on the cluster, Blind-Spot Collision Warning may not operate properly. Have the function be inspected by a professional workshop. Kia recommends to visit an authorised Kia dealer/service partner.
- If the rear corner radars have been replaced or repaired, have the vehicle inspected by a professional workshop. Kia recommends to visit an authorised Kia dealer/service partner.
- Use only Kia Genuine Parts or those of an equivalent standard to repair the rear bumper where the rear corner radar is located.
- Do not apply license plate frame or objects, such as a film, accessories, molding and sticker or a bumper painting near the rear corner radar.
- The function may not work properly if the bumper has been replaced, or the surroundings of the rear corner radar

has been damaged or paint has been applied.

- If a trailer, carrier or other equipments is installed, it may adversely affect the performance of the rear corner radar or the function may not operate.

Blind-Spot Collision Warning settings

Blind-Spot Safety



ONQ5031376L



ONQ5051101L

A: Driver assistance

- 1 Blind-spot safety
- 2 Warning only
- 3 Off

With the engine on, select or deselect 'Driver Assistance → Blind Spot Safety' from the Settings menu to set whether or not to use each function.

- Warning Only: Blind-Spot Collision Warning will warn the driver with audible warning will be applied depending on the collision risk levels. Braking will not be assisted, so driver operate the vehicle directly.
- Off: Blind-Spot Collision Warning will turn off.



ONQ5041145L

A: **Blind-Spot Safety System is Off**

If 'Blind-Spot Safety' function turn on (select except for 'Off' function), when the engine is restarted, the outside rear-view mirror will blink for 3 seconds. It means the function is operated.

When the engine is restarted with Blind-Spot Collision Warning off, the 'Blind-Spot Safety System is Off' message will appear on the cluster.

Warning Timing

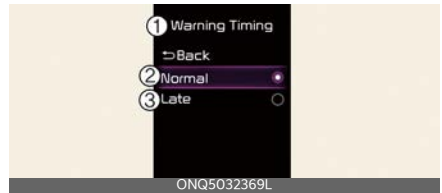

ONQ5032369L

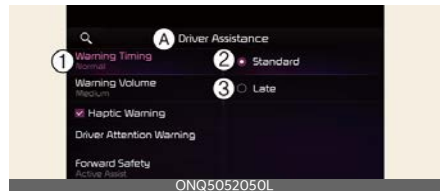

ONQ5052050L

A: Driver assistance

- 1 Warning timing
- 2 Normal
- 3 Late

With the engine on, select **Driver Assistance → Warning Timing** from the Settings menu to change the initial warning activation time for Blind-Spot Collision Warning.

To select the Warning time **Normal** or **Late**.

- **Normal:** Use under normal driving conditions. If it feels too sensitive, set the warning timing to **Late**.

*** NOTICE**

If you change the Warning Timing, the warning time of other Driver Assistance systems may change.

Warning methods

Type A

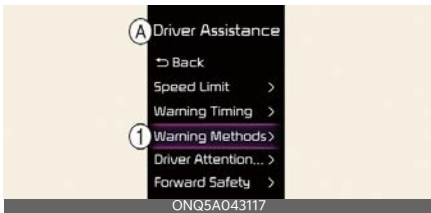

Type B

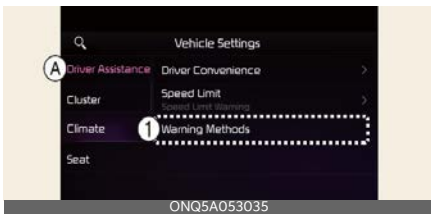

A: Driver Assistance
1 Warning Methods

The Warning Methods can be set with the vehicle on. Select **User Settings** → **Driver Assistance** → **Warning Methods** from the settings menu in the instrument cluster or **Settings** → **Vehicle** → **Driver Assistance** → **Warning Methods** from the settings menu in the infotainment system to change the following settings:

- **Warning Volume:** Adjusts the volume of the warning sound.

- **Haptic Warning:** Activate the steering wheel vibration warning. (if equipped)
- **Driving Safety Priority:** Lowers all other audio volumes when the Driving Safety system sounds a warning.

*** INFORMATION**

- If you change the Warning Methods, it can be applied to each function of the driver assistance system. Please check and change it in each function.
- If the vehicle is restarted, Warning Methods will maintain the last setting.
- The setting menu may not exist based on vehicle specification.
- The **Warning Volume** and **Haptic Warning** cannot be turned off at the same time. When one of the warning is turned off the other is activated.

Blind-Spot Collision Warning operation

Warning

Blind-Spot Collision Warning will warn as following operation.

- Vehicle detection
- Collision warning

Vehicle detection



- Warning light will appear in the outside rear view mirror.

Vehicle detection will operate as following circumstances.

- Vehicle speed: Above 20 km/h (12 mph)
- The speed of the vehicle in the blind spot area: Above 10 km/h (7 mph)

Collision warning

Collision warning will operate when the turn signal to change the lane in the direction of the vehicle in the blind spot area.

- To warn the driver of a collision, the warning light on the side view mirror will blink. At the same time, an audible warning will sound.
- When the turn signal is turned off or you move away from the lane, the collision warning will be cancelled and the function will return to vehicle detection state.
- Collision warning will operate as following circumstances:
 - Your driving speed: Above 40 km/h (25 mph)
 - The speed of the vehicle in the blind spot area: Above 10 km/h (7 mph)

* NOTICE

If collision warning is selected in the Blind-Spot Safety setting, collision warning will be activated even if you approach the lane in the direction of the vehicle in the blind spot side.

▲ WARNING

- The detecting range of the rear corner radar is determined by a standard road width, therefore, on a narrow road, the function may detect other vehicles in the next lane and warn you. In contrast, on a wide road, the function may not be able to detect a

vehicle driving in the next lane and may not warn you.

- When the hazard warning flasher is on, the collision warning by the turn signal will not operate.
- For your safety, change the Settings after parking the vehicle at a safe location.
- If any other system's warning message is displayed or audible warning is generated, Blind-Spot Collision Warning's warning message may not be displayed and audible warning may not be generated.
- You may not hear the warning sound of Blind-Spot Collision Warning if the surrounding is noisy.
- Blind-Spot Collision Warning may warn the driver late or may not warn the driver depending on the road and driving conditions.
- Driver should maintain control of the vehicle at all times. Do not depend on Blind-Spot Collision Warning. Maintain a safe braking distance, and if necessary, depress the brake pedal to reduce driving speed or to stop the vehicle.
- Never operate Blind-Spot Collision Warning on people, animal, objects, etc. It may cause serious injury or death.

* NOTICE

- If the driver's seat is on the left side, the collision warning may occur when you turn left. If the driver's seat is on the right side, the collision warning may occur when you turn right. Maintain a proper distance with the vehicles in the lane.

- Images or colours may be displayed differently depends on the instrument cluster specifications or theme.

Blind-Spot Collision Warning malfunction and limitations

Blind-Spot Collision Warning malfunction



A: Check Blind-Spot Safety system
 When Blind-Spot Collision Warning is not working properly, the warning message will appear on the cluster for several seconds, and the master warning light (⚠) will appear. Have Blind-Spot Collision Warning be inspected by a professional workshop. Kia recommends to visit an authorised Kia dealer/service partner.

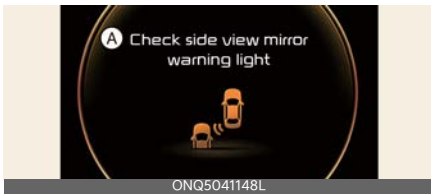

A: Check side view mirror warning light
 When the outside rearview mirror warning light is not working properly, the warning message will appear on the cluster for several seconds, and the master warning light (⚠) will appear. Have Blind-Spot Collision Warning be inspected by a professional workshop. Kia recommends to visit an authorised Kia dealer/service partner.

Blind-Spot Collision Warning disabled

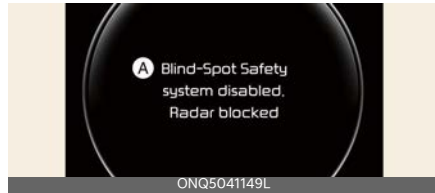

A: Blind-spot safety system disabled. Radar blocked

When the rear bumper around the rear corner radar or sensor is covered with foreign material, such as snow or rain, or installing a trailer or carrier, it can reduce the detecting performance and temporarily limit or disable Blind-Spot Collision Warning.

If this occurs, a warning message will appear on the cluster. However it is not a malfunction.

Blind-Spot Collision Warning will operate normally when such foreign material or trailer, other equipments is removed, and then the engine is restarted. Always keep it clean.

If Blind-Spot Collision Warning does not operate normally vehicle rear luggage, other equipment or foreign material is removed, have Blind-Spot Collision Warning be inspected by a professional workshop. Kia recommends to visit an authorised Kia dealer/service partner.

⚠ WARNING

- Even though the warning message does not appear on the cluster, Blind-Spot Collision-Avoidance Warning may not properly operate.
- Blind-Spot Collision Warning may not properly operate in an area (e.g. open terrain) where any substance are not detected right after the engine is

turned on, or when the detecting sensor is blocked with foreign material right after the engine is turned on.

CAUTION

Turn off Blind-Spot Collision Warning to install a trailer, carrier, etc., or remove the trailer, carrier, etc. to use Blind-Spot Collision Warning.

Limitations of Blind-Spot Collision Warning

Blind-Spot Collision Warning may not operate normally as following circumstances. Pay attention whilst driving.

- There is inclement weather, such as heavy snow, heavy rain, etc.
- The rear corner radar is covered with snow, rain, dirt, etc.
- The temperature around the rear corner radar is high or low
- The rear corner radar is covered by vehicle or pillar, walls etc.
- Driving on a highway (or motorway) ramp and tollgate.
- The road pavement (or the peripheral ground) abnormally contains metallic components (i.e. possibly due to sub-way construction).
- There is a fixed object near the vehicle, such as sound barriers, guardrails, double guardrails, central dividers, entry barriers, street lamps, signs, tunnels, walls, etc. (including double structures)
- Driving through a narrow road where trees or grass are overgrown
- Driving in areas with few nearby vehicles or structures (desert, grassland, suburbs, etc.)
- Driving on a wet road surface

- The other vehicle drives very close behind your vehicle, or the other vehicle passes by your vehicle in close proximity
- The speed of the other vehicle is very fast that it passes by your vehicle in a short time
- Your vehicle passes by the other vehicle
- Your vehicle changes lane
- Your vehicle has started at the same time as the vehicle next to you and has accelerated
- The vehicle in the next lane moves two lanes away from you, or when the vehicle two lanes away moves to the next lane from you
- A trailer or carrier is installed around the rear corner radar
- The bumper around the rear corner radar is covered with objects, such as a bumper sticker, bike rack, etc.
- The bumper around the rear corner radar is impacted, damaged or the radar is out of position
- Your vehicle height is low or high due to heavy loads, abnormal tyre pressure, etc.

When the following objects are detected:

- A motorcycle or bicycle is detected
- A vehicle such as a flat trailer is detected
- A big vehicle such as a bus or truck is detected
- A moving obstacle such as a pedestrian, animal, shopping cart or a baby stroller is detected
- A vehicle with low height such as a sports car is detected

WARNING



- Driving on a curved road
Blind-Spot Collision Warning may not operate properly when driving on a curved road. Blind-Spot Collision Warning may not detect the vehicle in the next lane.
Always pay attention to road and driving conditions whilst driving on a curved road.



Blind-Spot Collision Warning may not operate properly when driving on a curved road. Blind-Spot Collision Warning may detect a vehicle in the same lane.
Always pay attention to road and driving conditions whilst driving.



- Driving where the road is merging/dividing
Blind-Spot Collision Warning may not operate properly when driving where the road merges or divides. Blind-Spot

Collision Warning may not detect the vehicle in the next lane.
Always pay attention to road and driving conditions whilst driving on the road merges or divides.



- Driving on an inclined road
Blind-Spot Collision Warning may not operate properly when driving on a sloped road. Blind-Spot Collision Warning may not detect the vehicle in the next lane or may incorrectly detect the ground or structure.
Always pay attention to road and driving conditions whilst driving on a sloped road.



- Driving where the heights of the lanes are different
Blind-Spot Collision Warning may not operate properly when driving where the heights of the lanes (underpass joining sections, grade separated intersections, etc.) are different. Blind-Spot Collision Warning may not detect the

vehicle on a road with different lane heights.

Always pay attention to road and driving conditions whilst driving where the heights of the lanes are different.

⚠ WARNING

- When you are towing a trailer or another vehicle, make sure that you turn off Blind-Spot Collision Warning. Control safety may be reduced.
- Blind-Spot Collision Warning may not operate normally if interfered by strong electromagnetic waves.
- Blind-Spot Collision Warning may not operate for approximately 3 seconds after the vehicle is started, or rear corner radars are initialized.

Blind-Spot Collision-Avoidance Assist (BCA) (if equipped)

Blind-Spot Collision-Avoidance Assist is designed to help detect and monitor approaching vehicles in the driver's blind spot area and warn the driver of a possible collision with a warning message and audible warning.

In addition, if there is a risk of collision when changing lanes or driving forward out of a parking space, Blind-Spot Collision-Avoidance Assist will help avoid collision by applying the brake.



Blind-Spot Collision-Avoidance Assist helps detect and inform the driver that a vehicle is in the blind spot.

⚠ CAUTION

The detecting range may vary depending on the speed of your vehicle. However, even if there is a vehicle in the blind spot area, the function may not warn you when you pass by at high speeds.

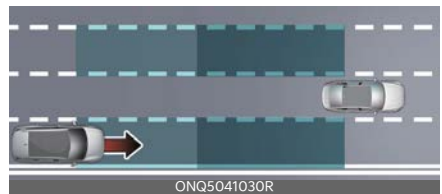

Blind-Spot Collision-Avoidance Assist helps detect and inform the driver that a vehicle is approaching at high speed from the blind spot area.

⚠ CAUTION

Warning timing may vary depending on the speed of the vehicle approaching at high speed.



When changing lanes by detecting the lane ahead, if Blind-Spot Collision-Avoidance Assist judges that there is a collision risk with an approaching vehicle in the blind spot, it will help avoid collision by applying the brake.



When you are driving forward out of a parking space, if Blind-Spot Collision-Avoidance Assist judges that there is a collision risk with an approaching vehicle in the blind spot, it will help avoid collision by applying the brake.

Detecting sensor

Front view camera



Rear corner radar



Refer to the picture above for the detailed location of the detecting sensors.

⚠ CAUTION

Take the following precautions to maintain optimal performance of the detecting sensor:

- Never disassemble the rear corner radar or radar assembly, or apply any impact on it.
- If there is impact on the rear corner radar or near the radar, even though the warning message does not appear on the cluster, Blind-Spot Safety system may not operate properly. Have the function be inspected by a professional workshop. Kia recommends visiting an authorised Kia dealer/service partner.
- If the rear corner radars have been replaced or repaired, have the vehicle inspected by a professional workshop. Kia recommends visiting an authorised Kia dealer/service partner.
- Use only Kia Genuine Parts or those of an equivalent standard to repair the rear bumper where the rear corner radar is located.
- Do not apply license plate frame or objects, such as a bumper sticker, film or a bumper guard near the rear corner radar.
- Blind-Spot Collision-Avoidance Assist may not work properly if the bumper

has been replaced, or the surroundings of the rear corner radar has been damaged or paint has been applied.

- If a trailer, carrier or other equipments is installed, it may adversely affect the performance of the rear corner radar or the function may not operate.

For more details on the precautions of the front view camera, refer to "Forward Collision-Avoidance Assist (FCA) (Front Camera Only) (if equipped)" on page 7-5.

Blind-Spot Collision-Avoidance Assist settings

Blind-spot safety

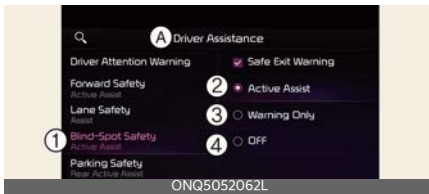

A: **Driver assistance**

- 1 **Blind-spot safety**
- 2 **Active Assist**
- 3 **Warning only**
- 4 **Off**

With the vehicle on, select or deselct **Driver assistance** → **Blind-spot safety** from the Settings menu to set whether or not to use each function.

- **Active Assist:** Blind-Spot Collision-Avoidance Assist will warn the driver with a warning message, an audible warning, steering wheel vibration (if equipped) and braking assist will be applied depending on the collision risk levels.
- **Warning only:** Blind-Spot Collision-Avoidance Assist will warn the driver with a warning message, an audible

warning and steering wheel vibration (if equipped) depending on the collision risk levels. Braking will not be assisted.

- **Off:** Blind-Spot Collision-Avoidance Assist will turn off.



A: **Blind-Spot Safety System is Off**

When the vehicle is restarted with Blind-Spot Collision-Avoidance Assist off, the **Blind-Spot Safety System is Off** message will appear on the cluster.

If you change the setting from **Off** to **Active Assist** or **Warning only**, the warning light on the outside rear view mirror will blink for three seconds.

In addition, if the vehicle is turned on, when Blind-Spot Collision-Avoidance Assist is set to **Active Assist** or **Warning only**, the warning light on the outside rear view mirror will blink for three seconds.

⚠ WARNING

- If **Warning only** is selected, braking is not assisted.
- If **Off** is selected, the driver should always be aware of the surroundings and drive safely.

*** NOTICE**

If the vehicle is restarted, Blind-Spot Collision-Avoidance Assist will maintain the last setting.

Warning timing

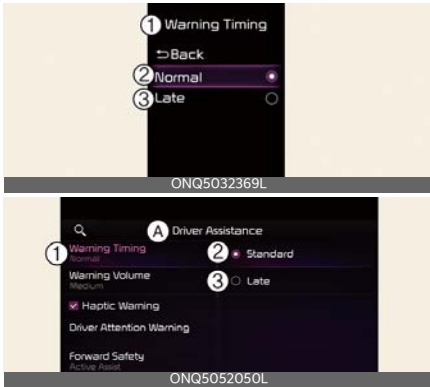

A: Driver assistance

1 Warning timing

2 Normal

3 Late

With the vehicle on, select **Driver assistance** → **Warning timing** from the Settings menu to change the initial warning activation time for Blind-Spot Collision-Avoidance Assist.

To select the Warning time **Normal** or **Late**.

- **Normal:** Use under normal driving conditions. If it feels too sensitive, set the warning timing to **Late**.
- **Late:** The warning timing will be late

Warning methods

Type A

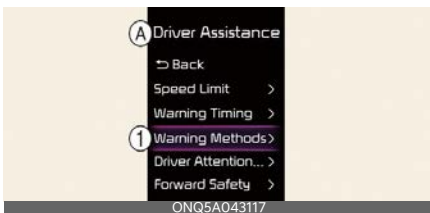

Type B

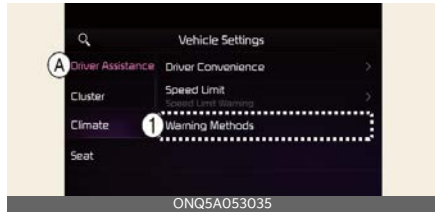

A: Driver Assistance

1 Warning Methods

The Warning Methods can be set with the vehicle on. Select **User Settings** → **Driver Assistance** → **Warning Methods** from the settings menu in the instrument cluster or **Settings** → **Vehicle** → **Driver Assistance** → **Warning Methods** from the settings menu in the infotainment system to change the following settings:

- **Warning Volume:** Adjusts the volume of the warning sound.
- **Haptic Warning:** Activate the steering wheel vibration warning. (if equipped)
- **Driving Safety Priority:** Lowers all other audio volumes when the Driving Safety system sounds a warning.

* INFORMATION

- If you change the Warning Methods, it can be applied to each function of the driver assistance system. Please check and change it in each function.
- If the vehicle is restarted, Warning Methods will maintain the last setting.
- The setting menu may not exist based on vehicle specification.
- The **Warning Volume** and **Haptic Warning** cannot be turned off at the same time. When one of the warning is turned off the other is activated.

Blind-Spot Collision-Avoidance Assist operation

Warning and control

Blind-Spot Collision-Avoidance Assist will warn and control as following operation.

- Vehicle detection
- Collision Warning
- Collision-Avoidance Assist

Vehicle detection



- Warning light will appear in the outside rear view mirror.

Vehicle detection will operate as following circumstances.

- Vehicle speed: Above 20 km/h (12 mph)
- The speed of the vehicle in the blind spot area: Above 10 km/h (7 mph)

Collision warning

Collision warning will operate when the turn signal to change the lane in the direction of the vehicle in the blind spot area.

- If **Warning only** is selected from the Settings menu, the collision warning will operate when your vehicle approaches the lane the blind spot vehicle is detected.
- To warn the driver of a collision, the warning light on the side view mirror will blink. At the same time, an audible

warning will sound and the steering wheel will vibrate (if equipped).

- When the turn signal is turned off or you move away from the lane, the collision warning will be cancelled and the function will return to vehicle detection state.
- Collision warning will operate as following circumstances:
 - Your driving speed: Above 40 km/h (25 mph)
 - The speed of the vehicle in the blind spot area: Above 10 km/h (7 mph)

⚠ WARNING

- The detecting range of the rear corner radar is determined by a standard road width, therefore, on a narrow road, the function may detect other vehicles in the two lanes away and warn you. In contrast, on a wide road, the function may not be able to detect a vehicle driving in the next lane and may not warn you.
- When the hazard warning flasher is on, the collision warning by the turn signal will not operate.

* NOTICE

If the driver's seat is on the left side, the collision warning may occur when you turn left. If the driver's seat is on the right side, the collision warning may occur when you turn right. Maintain a proper distance with the vehicles in the lane.

Collision-Avoidance Assist (parallel exit)

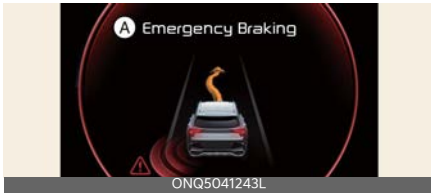

A: Emergency braking

- To warn the driver of a collision, the warning light on the side view mirror will blink and a warning message will appear on the cluster. At the same time, an audible warning will sound and the steering wheel will vibrate (if equipped). It assists in braking control to help prevent collision with the vehicle in the blind spot area.
- Collision-Avoidance Assist will be operated under the following circumstances.
 - Your vehicle speed: 60~200 km/h (40~120 mph)
 - Both lane markings of the driving lane are detected.

⚠ WARNING

- Collision-Avoidance Assist will be cancelled under the following circumstances:
 - Your vehicle enters the next lane by a certain distance
 - Your vehicle is away from the collision risk
 - The steering wheel is sharply steered
 - The brake pedal is depressed
 - Forward Collision-Avoidance Assist is operating
- After Blind-Spot Collision-Avoidance Assist operation or changing lane, you

must drive to the centre of the lane. The function will not operate if the vehicle is not driven in the centre of the lane.

Collision-Avoidance Assist (whilst departing)



A: Emergency braking

- To warn the driver of a collision, the warning light on the outside rear view mirror will blink and a warning message will appear on the cluster. At the same time, an audible warning will sound and the steering wheel will vibrate (if equipped).
- Blind-Spot Collision-Avoidance Assist will operate when your vehicle speed is below 3 km/h (2 mph) and the speed of the vehicle in the blind spot area is above 5 km/h (3 mph).
- Emergency braking will be assisted to help prevent collision with the vehicle in the blind spot area.



A: Drive carefully

When the vehicle is stopped due to emergency braking, the warning message will appear on the cluster. For your safety, the driver should depress the

brake pedal immediately and check the surroundings.

- Brake control will end after the vehicle is stopped by emergency braking for approximately 2 seconds.

WARNING

Take the following precautions when using Blind-Spot Collision-Avoidance Assist:

- For your safety, change the Blind-Spot Safety system Settings after parking the vehicle at a safe location.
- If any other function's warning message is displayed or audible warning is generated, Blind-Spot Collision-Avoidance Assist's warning message may not be displayed and audible warning may not be generated.
- You may not hear the warning sound of Blind-Spot Collision-Avoidance Assist if the surrounding is noisy.
- Blind-Spot Collision-Avoidance Assist may not operate if the driver applies the brake pedal to avoid collision.
- When Blind-Spot Collision-Avoidance Assist is operating, braking control by the function will automatically cancel when the driver excessively depresses the accelerator pedal or control the steering wheel.
- During Blind-Spot Collision-Avoidance Assist operation, the vehicle may stop suddenly injuring passengers and shifting loose objects. Always have the seat belt on and keep loose objects secured.
- Even if there is a problem with Blind-Spot Collision-Avoidance Assist, the vehicle's basic braking performance will operate normally.

- Blind-Spot Collision-Avoidance Assist does not operate in all situations or cannot avoid all collisions.
- Blind-Spot Collision-Avoidance Assist may warn the driver late or may not warn the driver depending on the road and driving conditions.
- Driver should maintain control of the vehicle at all times. Do not depend on Blind-Spot Collision-Avoidance Assist. Maintain a safe braking distance, and if necessary, depress the brake pedal to reduce driving speed or to stop the vehicle.

WARNING

- The brake control may not operate properly depending on the status of ESC (Electronic Stability Control). There will only be a warning when:
 - The ESC (Electronic Stability Control) warning light is on
 - ESC (Electronic Stability Control) is engaged in a different function

NOTICE

The images or colours may be displayed differently depending on the specifications of the instrument cluster or theme.

Blind-Spot Collision-Avoidance Assist malfunction and limitations

Blind-Spot Collision-Avoidance Assist malfunction



A: Check Blind-Spot Safety system
 When Blind-Spot Collision-Avoidance Assist is not working properly, the warning message will appear on the cluster for several seconds, and the master warning light (⚠️) will appear. Have Blind-Spot Collision-Avoidance Assist be inspected by a professional workshop. Kia recommends visiting an authorised Kia dealer/service partner.

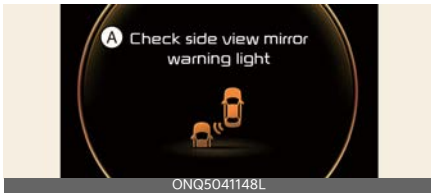

A: Check side view mirror warning light
 When the outside rear view mirror warning light is not working properly, the warning message will appear on the cluster for several seconds, and the master warning light (⚠️) will appear. Have Blind-Spot Collision-Avoidance Assist be inspected by a professional workshop. Kia recommends visiting an authorised Kia dealer/service partner.

Blind-Spot Collision-Avoidance Assist disabled

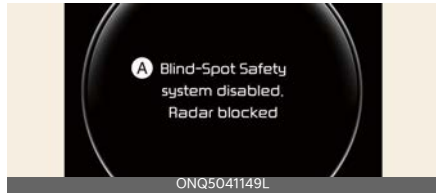

A: Blind-spot safety system disabled. Radar blocked

When the rear bumper around the rear corner radar or sensor is covered with foreign material, such as snow or rain, or installing a trailer or carrier, it can reduce the detecting performance and temporarily limit or disable Blind-Spot Collision-Avoidance Assist.

If this occurs, a warning message will appear on the cluster. However it is not a malfunction.

Blind-Spot Collision-Avoidance Assist will operate normally when such foreign material or trailer, other equipments is removed, and then the vehicle is restarted. Always keep it clean.

If Blind-Spot Collision-Avoidance Assist does not operate normally vehicle rear luggage, other equipment or foreign material is removed, have Blind-Spot Collision-Avoidance Assist be inspected by a professional workshop. Kia recommends visiting an authorised Kia dealer/service partner.

⚠️ WARNING

- Even though the warning message does not appear on the cluster, Blind-Spot Collision-Avoidance Assist may not properly operate.
- Blind-Spot Collision-Avoidance Assist may not properly operate in an area (e.g. open terrain) where any sub-

stance are not detected right after the vehicle is turned on, or when the detecting sensor is blocked with foreign material right after the vehicle is turned on.

CAUTION

Turn off Blind-Spot Collision-Avoidance Assist to install a trailer, carrier, etc., or remove the trailer, carrier, etc. to use Blind-Spot Collision-Avoidance Assist.

Limitations of Blind-Spot Collision-Avoidance Assist

Blind-Spot Collision-Avoidance Assist may not operate normally as following circumstances:

- There is inclement weather, such as heavy snow, heavy rain, etc.
- The rear corner radar is covered with snow, rain, dirt, etc.
- The temperature around the rear corner radar is high or low
- The rear corner radar is covered by vehicle or pillar, walls etc.
- Driving on a highway (or motorway) ramp and tollgate.
- The road pavement (or the peripheral ground) abnormally contains metallic components (i.e. possibly due to subway construction).
- There is a fixed object near the vehicle, such as sound barriers, guardrails, double guardrails, central dividers, entry barriers, street lamps, signs, tunnels, walls, etc. (including double structures)
- Driving through a narrow road where trees or grass are overgrown
- Driving in large areas where there are few vehicles or structures (i.e. desert, meadow, suburb, etc.)
- Driving on a wet road surface, such as a puddle on the road
- The other vehicle drives very close behind your vehicle, or the other vehicle passes by your vehicle in close proximity
- The speed of the other vehicle is very fast that it passes by your vehicle in a short time
- Your vehicle passes by the other vehicle
- Your vehicle changes lane
- Your vehicle has started at the same time as the vehicle next to you and has accelerated
- The vehicle in the next lane moves two lanes away from you, or when the vehicle two lanes away moves to the next lane from you
- A trailer or carrier is installed around the rear corner radar
- The bumper around the rear corner radar is covered with objects, such as a bumper sticker, bike rack, etc.
- The bumper around the rear corner radar is impacted, damaged or the radar is out of position
- Your vehicle height is low or high due to heavy loads, abnormal tyre pressure, etc.

Blind-Spot Collision-Avoidance Assist may not operate normally, or it may operate unexpectedly when the following objects are detected:

- A motorcycle or bicycle is detected
- A vehicle such as a flat trailer is detected
- A big vehicle such as a bus or truck is detected
- A moving obstacle such as a pedestrian, animal, shopping cart or a baby stroller is detected

- A vehicle with low height such as a sports car is detected
- Braking control may not work as following circumstances:

- The vehicle severely vibrates whilst driving over a bumpy road, uneven road or concrete patch
- Driving on a slippery surface due to snow, water puddle, ice, etc.
- The tyre pressure is low or a tyre is damaged
- The brake is reworked
- The vehicle makes abrupt lane changes

*** NOTICE**

For more details on the limitations of the front view camera, refer to "Forward Collision-Avoidance Assist (FCA) (Front Camera Only) (if equipped)" on page 7-5 and "Lane Keeping Assist (LKA) (if equipped)" on page 7-26.

⚠ WARNING

- Driving on a curved road



Blind-Spot Collision-Avoidance Assist may not operate properly when driving on a curved road. Blind-Spot Collision-Avoidance Assist may not detect the vehicle in the next lane.

Always pay attention to road and driving conditions whilst driving.



Blind-Spot Collision-Avoidance Assist may not operate properly when driving on a curved road. Blind-Spot Collision-Avoidance Assist may detect a vehicle in the same lane.

Always pay attention to road and driving conditions whilst driving.

- Driving where the road is merging/ dividing



Blind-Spot Collision-Avoidance Assist may not operate properly when driving where the road merges or divides. Blind-Spot Collision-Avoidance Assist may not detect the vehicle in the next lane.

Always pay attention to road and driving conditions whilst driving on the road merges or divides.

- Driving on an inclined road

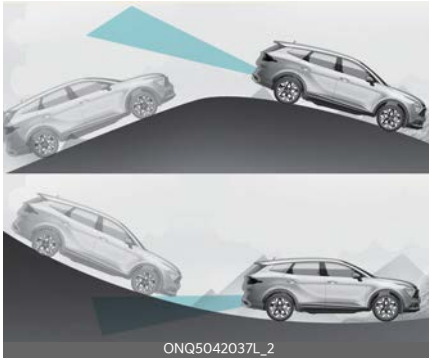

Blind-Spot Collision-Avoidance Assist may not operate properly when driving on a sloped road. Blind-Spot Collision-Avoidance Assist may not detect the vehicle in the next lane or may incorrectly detect the ground or structure.

Always pay attention to road and driving conditions whilst driving.

- Driving where the heights of the lanes are different



Blind-Spot Collision-Avoidance Assist may not operate properly when driving where the heights of the lanes are different. Blind-Spot Collision-Avoidance Assist may not detect the vehicle on a road with different lane heights.

Always pay attention to road and driving conditions whilst driving.

⚠ WARNING

- When you are towing a trailer or another vehicle, make sure that you turn off Blind-Spot Collision-Avoidance Assist.
- Blind-Spot Collision-Avoidance Assist may not operate normally if interfered by strong electromagnetic waves.
- Blind-Spot Collision-Avoidance Assist may not operate for approximately 15 seconds after the vehicle is started, or the front view camera or rear corner radars are initialized.

Safe Exit Warning (SEW) (if equipped)



After the vehicle stops, when an approaching vehicle from the rear area is detected as soon as a passenger opens a door, Safe Exit Warning will warn the driver with a warning message and an audible warning to help prevent a collision.

⚠ CAUTION

Warning timing may vary depending on the speed of the approaching vehicle.

Detecting sensor

Rear corner radar



Refer to the picture above for the detailed location of the detecting sensors.

⚠ CAUTION

For more details on the precautions of the rear corner radars, refer to "Blind-Spot Collision-Avoidance Assist (BCA) (if equipped)" on page 7-39.

Safe Exit Warning settings SEW (Safe Exit Warning)

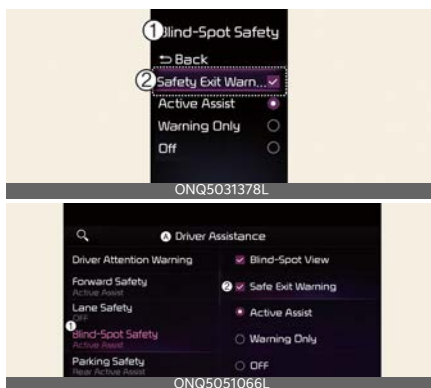

A: **Driver assistance**

1 **Blind-spot safety**

2 **Safe Exit Warning**

With the vehicle on, select **Driver assistance** → **Blind-spot safety** → **Safe Exit Warning** from the Settings menu to turn on Safe Exit Warning and deselect to turn off the function.

⚠ WARNING

The driver should always be aware of unexpected and sudden situations from occurring. If **SEW (Safe Exit Warning)** is deselected, Safe Exit Warning cannot warn you.

* NOTICE

If the vehicle is restarted, Safe Exit Warning will maintain the last setting.

Warning methods

Type A

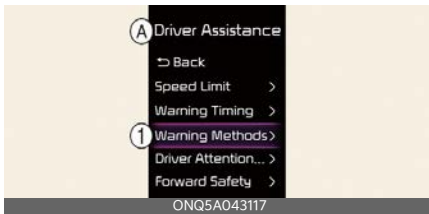

Type B



A: Driver Assistance

1 Warning Methods

The Warning Methods can be set with the vehicle on. Select **User Settings** → **Driver Assistance** → **Warning Methods** from the settings menu in the instrument cluster or **Settings** → **Vehicle** → **Driver Assistance** → **Warning Methods** from the settings menu in the infotainment system to change the following settings:

- **Warning Volume:** Adjusts the volume of the warning sound.
- **Driving Safety Priority:** Lowers all other audio volumes when the Driving Safety system sounds a warning.

* INFORMATION

- If you change the Warning Methods, it can be applied to each function of the driver assistance system. Please check and change it in each function.
- If the vehicle is restarted, Warning Methods will maintain the last setting.

- The setting menu may not exist based on vehicle specification.

Safe Exit Warning operation

Warning

Safe Exit Warning warns the following actions.

Collision warning when exiting vehicle



A: Watch for traffic

- The warning light on the side view mirror will blink and the warning message will appear on the cluster, and an audible warning will sound.
- Safe Exit Warning will warn under the following circumstances:
 - Your vehicle speed: below 3 km/h (2 mph)
 - The speed of the approaching vehicle from the rear: above 6 km/h (4 mph)

⚠ WARNING

Take the following precautions when using Safe Exit Warning:

- For your safety, change the Settings after parking the vehicle at a safe location.
- If any other function's warning message is displayed or audible warning is generated, Safe Exit Warning warning message may not be displayed and audible warning may not be generated.
- You may not hear the warning sound of Safe Exit Warning if the surrounding is noisy.
- Safe Exit Warning does not operate in all situations or cannot prevent all collisions.
- Safe Exit Warning may warn the driver late or may not warn the driver depending and driving conditions. Always check vehicle surroundings.
- The driver and passengers are responsible for accidents that occurs whilst exiting the vehicle. Always check the surroundings before you exit the vehicle.
- Safe Exit Warning does not operate if there is a problem with Blind-Spot Collision Warning or Blind-Spot Collision-Avoidance Assist:
- The warning message of Blind-Spot Collision Warning or Blind-Spot Collision-Avoidance Assist is appeared when:
 - Blind-Spot Collision Warning or Blind-Spot Collision-Avoidance Assist sensor or the sensor surrounding is polluted or covered
 - Blind-Spot Collision Warning or Blind-Spot Collision-Avoidance Assist fails to warn passengers or falsely warn passengers

*** NOTICE**

- After the vehicle is turned off, Safe Exit Warning operates for 3 minutes, but turns off immediately if the doors are locked.
- Images or colours may be displayed differently depends on the instrument cluster specifications or theme.

Safe Exit Warning malfunction and limitations

Safe Exit Warning malfunction



A: Check Blind-Spot Safety system

When Safe Exit Warning is not working properly, the warning message will appear on the cluster, and the master warning light (⚠) will appear on the cluster. Have Safe Exit Warning be inspected by a professional workshop. Kia recommends visiting an authorised Kia dealer/ service partner.

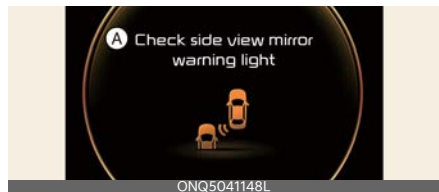

A: Check side view mirror warning light

When the side view mirror warning light is not working properly, the warning message will appear on the cluster for several seconds, and the master warning light (⚠) will appear on the cluster.

Have Safe Exit Warning be inspected by a professional workshop. Kia recommends visiting an authorised Kia dealer/service partner.

Safe Exit Warning disabled

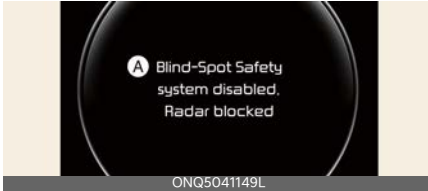

A: **Blind-spot safety system disabled. Radar blocked**

When the rear bumper around the rear corner radar or sensor is covered with foreign material, such as snow or rain, or installing a trailer or carrier, it can reduce the detecting performance and temporarily limit or disable Safe Exit Warning. If this occurs, the **Blind-Spot Safety system disabled. Radar blocked** warning message will appear on the cluster. Safe Exit Warning will operate normally when such foreign material or trailer, etc. is removed, and then the vehicle is restarted.

If Safe Exit Warning does not operate normally after it is removed, Kia recommends visiting an authorised Kia dealer/service partner.

WARNING

- Even though the warning message does not appear on the cluster, Safe Exit Warning may not properly operate.
- Safe Exit Warning may not properly operate in an area (e.g., open terrain), where any substance are not detected right after the vehicle is turned on, or when the detecting sensor is blocked

with foreign material right after the vehicle is turned on.

CAUTION

Turn off Safe Exit Warning to install a trailer, carrier, etc., or remove the trailer, carrier, etc. to use Safe Exit Warning.

Limitations of Safe Exit Warning

Safe Exit Warning may not operate normally, or Safe Exit Warning may operate unexpectedly under the following warning.

- Getting out of the vehicle where trees or grass are overgrown
- Getting out of the vehicle where the road is wet
- The approaching vehicle is very fast or very slow

*** NOTICE**

For more details on the precautions of the rear corner radars, refer to "Blind-Spot Collision-Avoidance Assist (BCA) (if equipped)" on page 7-39.

WARNING

- Safe Exit Warning may not operate normally if interfered by strong electromagnetic waves.
- Safe Exit Warning may not operate for 3 seconds after the vehicle is restarted, or the rear corner radars are initialized.

Manual Speed Limit Assist (MSLA)



- 1 Speed Limit indicator
- 2 Set speed

You can set the speed limit when you do not want to drive over a specific speed. If you drive over the preset speed limit, the warning function operates (set speed limit will blink and chime will sound) until the vehicle speed returns within the speed limit.

Manual Speed Limit Assist operation

Setting speed limit

1. Press and hold Driving Assist (DA) button at the desired speed.



The speed limit indicator (LIMIT) light will appear on the cluster.

2. Push the + switch up or - switch down, and release it at the desired speed. Push the + switch up or - switch down and hold it. The speed will increase or decrease to the nearest multiple of ten (multiple of five in mph) at first, and then increase or decrease by 10 km/h (5 mph).



3. The set speed limit (1) will be displayed on the cluster. If you would like to drive over the preset speed limit, depress the accelerator pedal beyond the pressure point to activate the kick-down mechanism.

The set speed limit will blink and chime will sound until you return the vehicle speed within the speed limit.



* NOTICE

When the accelerator pedal is not depressed beyond the pressure point, vehicle speed will maintain within the speed limit.

Temporarily pausing Manual Speed Limit Assist



Press the (LIMIT) switch to temporarily pause the set speed limit. The set speed limit will turn off but the Speed Limit indicator (LIMIT) will stay on.

Resuming Manual Speed Limit Assist



To resume Manual Speed Limit Assist after the function was paused, operate the +, -, (LIMIT) switch.

If you push the + switch up or - switch down, vehicle speed will be set to the current speed on the cluster.

If you press the (LIMIT) switch, vehicle speed will resume to the preset speed.

Turning off Manual Speed Limit Assist



Press the Driving Assist (Driving Assist) button to turn Manual Speed Limit Assist off. The Speed Limit indicator (LIMIT) will go off.

Always press the Driving Assist (Driving Assist) button to turn Manual Speed Limit Assist off when not in use.

⚠ WARNING

Take the following precautions when using Manual Speed Limit Assist:

- Always set the vehicle speed to the speed limit in your country.
- Keep Manual Speed Limit Assist off when the function is not in use, to avoid inadvertently setting a speed. Check that the Speed Limit indicator (LIMIT) is off.
- Manual Speed Limit Assist does not substitute for proper and safe driving. It is the responsibility of the driver to always drive safely and should always be aware of unexpected and sudden situations from occurring. Pay attention to the road conditions at all times.

* NOTICE

The images or colours may be displayed differently depending on the specifications of the instrument cluster or theme.

Intelligent Speed Limit Assist (ISLA) (if equipped)

Intelligent Speed Limit Assist uses information from the detected road sign and navigation system to inform the driver of the speed limit and additional road signs of the current road. Also, the function helps the driver to maintain within the speed limit of the road.

⚠ CAUTION

- Intelligent Speed Limit Assist may not operate properly if the function is used in other countries.
- Update navigation system regularly for Intelligent Speed Limit Assist to operate normally.

Detecting sensor

Front view camera



Refer to the picture above for the detailed location of the detecting sensor.

⚠ CAUTION

For more precautions related to the camera sensor, refer to "Forward Collision-Avoidance Assist (FCA) (Front Camera Only) (if equipped)" on page 7-5.

Intelligent Speed Limit Assist settings

Speed limit

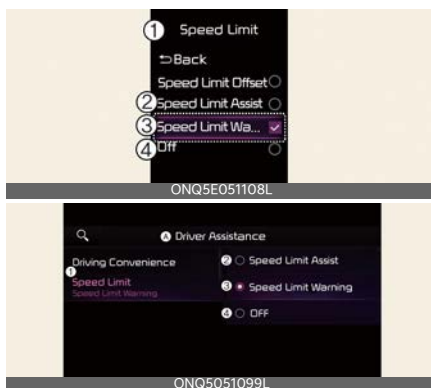

A: **Driver assistance**

- 1 **Speed limit**
- 2 **Speed limit assist**
- 3 **Speed limit warning**
- 4 **Off**

With the vehicle on, select or deselect **Driver assistance** → **Speed limit** from the Settings menu to set whether or not to use each function.

- If **Speed limit Assist** is selected, Intelligent Speed Limit Assist will inform the driver of speed limit and additional road signs. In addition, Intelligent Speed Limit Assist will inform the driver to change set speed of Manual Speed Limit Assist or Smart Cruise Control (If equipped) to help the driver stay within the speed limit.
- If **Speed limit warning** is selected, Intelligent Speed Limit Assist will inform the driver of speed limit and additional road signs. In addition, Intelligent Speed Limit Assist will warn the driver when the vehicle is driven faster than the speed limit. Manual Speed Limit Assist or Smart Cruise

Control (If equipped) set speed will not be automatically adjusted. The driver should adjust the speed manually.

- If **Off** is selected, Intelligent Speed Limit Assist will turn off.

Speed limit offset (for Europe, Australia, Russia)



A: Driver assistance

1 Speed limit

2 Speed limit offset (km/h)

With the vehicle on, when **Driver assistance** → **Speed limit** → **Speed limit offset** is selected, from the Settings menu the Speed Limit Offset can be changed. Speed Limit Warning and Speed Limit Assist will operate by applying the Speed Limit Offset setting to the detected speed limit.

WARNING

- For your safety, change the Settings after parking the vehicle at a safe location.
- Speed Limit Assist function operates based on the Offset setting added to the speed limit. If you want to change

the set speed according to the speed limit, set the offset to **0**.

- Speed Limit Warning function warns the driver when driving speed exceeds the speed at which the set Offset is added to speed limit. If you want Speed Limit Warning to warn you immediately when the driving speed exceeds the speed limit, set the offset to **0**.

Intelligent Speed Limit Assist operation

Warning and control

Intelligent Speed Limit Assist will warn and control the vehicle by 'Displaying speed limit', 'Warning overspeed' and 'Changing set speed'.

* NOTICE

Intelligent Speed Limit Assist warning and control are described based on the Offset set to **0**. For details on Offset setting, refer to "Intelligent Speed Limit Assist settings" on page 7-56.

Displaying speed limit



Speed limit information is displayed on the instrument cluster.

* NOTICE

- If speed limit information of the road cannot be recognised, '---' sign will be displayed. Please refer to "Limitations

of Intelligent Speed Limit Assist" if the road signs are difficult to recognise.

- Intelligent Speed Limit Assist provides additional road sign information in addition to speed limit. The additional road sign information provided may vary according to your country.
- Supplementary sign displayed under the speed limit or overtaking restriction sign means the conditions under which the signs must be followed. If the supplementary sign is not recognised, it will be displayed as blank.

Warning overspeed



When driving at a speed higher than the displayed speed limit, the red speed limit indicator will blink.

Changing set speed



If the speed limit of the road changes during the operation of Manual Speed Limit Assist or Smart Cruise Control (if equipped), an arrow in the direction of up or down is displayed to inform the driver that the set speed needs to be changed. At this time, the driver can change the set speed according to the speed limit by using the + or - switch on the steering wheel.

⚠ WARNING

- If the Offset is set over **0**, the set speed will change to a higher speed than the speed limit of the road. If you want to drive below the speed limit, set the Offset under **0** or use the - switch on the steering wheel to lower the set speed.
- Even after changing the set speed according to the speed limit of the road, the vehicle can still be driven over the speed limit. If necessary, depress the brake pedal to reduce your driving speed.
- If the speed limit of the road is under 30 km/h (20 mph), the set speed change function will not work.
- Intelligent Speed Limit Assist operates using the speed unit in the instrument cluster set by the driver. If the speed unit is set to a unit other than the speed unit used in your country, Intelligent Speed Limit Assist may not operate properly.

* NOTICE

- For more details on function operation of Manual Speed Limit Assist, refer to "Manual Speed Limit Assist (MSLA)" on page 7-54.
- For more details on operation of Smart Cruise Control, refer to "Smart

Cruise Control (SCC) (if equipped)" on page 7-70.

* NOTICE

The images or colours may be displayed differently depending on the specifications of the instrument cluster or theme.

Intelligent Speed Limit Assist malfunction and limitations

Intelligent Speed Limit Assist malfunction

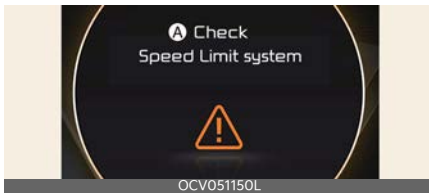

A: Check Speed Limit system

When Intelligent Speed Limit Assist is not working properly, the warning message will appear on the cluster for several seconds, and the master (⚠) warning light will appear on the cluster. If this occurs, we recommend the function checked by an authorised Kia dealer/service partner.

Intelligent Speed Limit Assist disabled

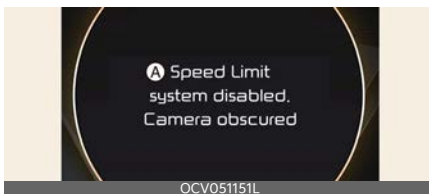

A: Speed limit system disabled. Camera obscured

When the front windscreen where the front view camera is located is covered

with foreign material, such as snow or rain, it can reduce the detecting performance and temporarily limit or disable Intelligent Speed Limit Assist.

If this occurs, the warning message will appear on the cluster. The function will operate normally when snow, rain or foreign material is removed.

If Intelligent Speed Limit Assist does not operate normally after it is removed, we recommend the function checked by an authorised Kia dealer/service partner.

* NOTICE

Even though the warning message or warning light does not appear on the cluster, Intelligent Speed Limit Assist may not operate properly.

Limitations of Intelligent Speed Limit Assist

Intelligent Speed Limit Assist may not operate normally, or the function may operate unexpectedly under the following circumstances:

- The road sign is contaminated or indistinguishable
 - The road sign is difficult to see due to bad weather, such as rain, snow, fog, etc.
 - The road sign is not clear or damaged
 - The road sign is partially obscured by surrounding objects or shadow
- A road sign near the road you are driving is detected
- The road signs do not conform to the standard
 - The text or picture on the road sign is different from the standard

- The road sign is installed between the main line and the exit road or between diverging roads
- A conditional road sign is not installed with a sign located on the road to enter or exit
- A sign is attached to another vehicle
- The distance between the vehicle and the road signs is too far
- The vehicle encounters illuminating road signs
- Intelligent Speed Limit Assist incorrectly recognises numbers in the street signals or other signs as the speed limit
- The minimum speed limit sign on the road is recognised incorrectly
- A lot of signs are installed together
- The brightness changes suddenly, for example when entering or exiting a tunnel or passing under a bridge
- Headlamps are not used or the brightness of the headlamps are weak at night or in the tunnel
- Road signs are difficult to recognise due to the reflection of sunlight, street lights, or oncoming vehicles
- The navigation information or GPS information contain errors.
- The driver does not follow the guide of the navigation.
- The driver is driving a new road that is not in the navigation system yet.
- The field of view of the Front view camera is obstructed by sun glare
- Driving on a road that is sharply curved or continuously curved
- Driving through speed bumps, or driving up and down or left to right on steep inclines

- The vehicle is shaking heavily
- There is an error in the navigation map information or GPS information

WARNING

- Intelligent Speed Limit Assist is a supplemental function that helps the driver to comply with the speed limit on the road, and may not display the correct speed limit or control the driving speed properly.
- Intelligent Speed Limit Assist may not operate for 15 seconds after the vehicle is started, or the front view camera is initialized.
- It is the responsibility of the driver to keep the speed limit.

NOTICE

For more details on the limitations of the front view camera, refer to "Forward Collision-Avoidance Assist (FCA) (Front Camera Only) (if equipped)" on page 7-5.

Driver Attention Warning (DAW) (if equipped)

Basic function

Driver Attention Warning will help determine the driver's attention level by analyzing driving pattern, driving time, etc. whilst vehicle is being driven. Driver Attention Warning will recommend a break when the driver's attention level falls below a certain level.

Leading vehicle departure alert function

Leading Vehicle Departure Alert function will inform the driver when the front vehicle departs from a stop.

Detecting sensor

Front view camera



The front view camera is used to detect driving patterns and front vehicle departure whilst vehicle is being driven.

Refer to the picture above for the detailed location of the detecting sensor.

CAUTION

Always keep the front view camera in good condition to maintain optimal performance of Driver Attention Warning. For more details on the precautions of the front view camera, refer to "Forward Collision-Avoidance Assist (FCA) (Front

Camera Only) (if equipped)" on page 7-5.

Driver Attention Warning settings

DAW (Driver Attention Warning)

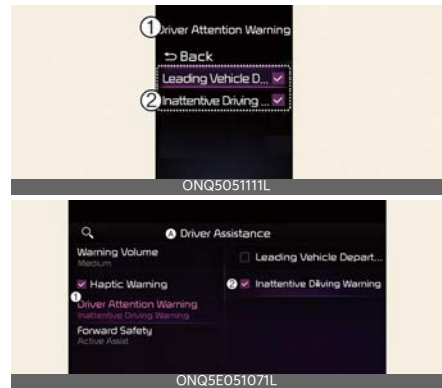

A: Driver assistance

1 Driver Attention Warning

2 Inattentive driving warning

With the vehicle on, select or deselect **Driver assistance** → **Driver Attention Warning** from the Settings menu to set whether or not to use each function.

- Inattentive Driving Warning: Driver Attention Warning will inform the driver the driver's attention level and will recommend taking a break when the level falls below a certain level.

*** NOTICE**

Whenever the vehicle is turned on, Inattentive Driving Warning will always turn on. (For Europe, Australia, Russia)

Leading Vehicle Departure Alert



- A: Driver assistance
- 1 Driver Attention Warning
- 2 Leading Vehicle Departure Alert

Leading Vehicle Departure Alert: The function will inform the driver when the front vehicle departs from a stop.

Warning timing

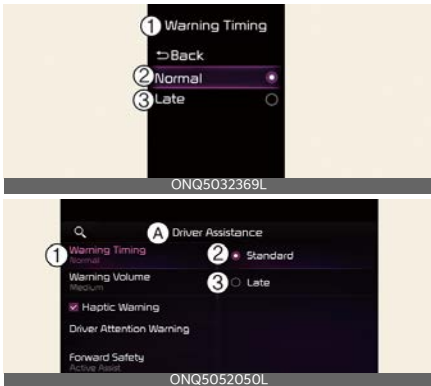

- A: Driver assistance
- 1 Warning timing
- 2 Normal
- 3 Late

With the vehicle on, select **Driver assistance** → **Warning timing** from the Settings menu to change the initial warning

activation time for Driver Attention Warning.

- **Normal:** Use in a normal driving environment. If Driver Attention Warning operates too sensitive, set the warning timing to **Late**.
- **Late:** The warning timing will be late

* NOTICE

If you change the Warning Timing, the warning time of other Driver Assistance systems may change. If the vehicle is restarted, Driver Warning Time will maintain the last setting.

Driver Attention Warning operation

Display and warning

The basic functions of Driver Attention Warning include:

- Attention Level
- Consider taking a break

Attention level

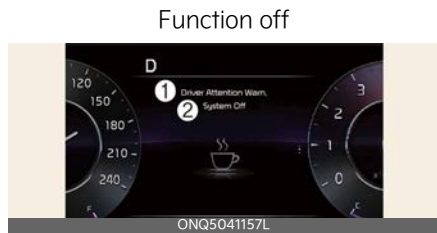

- 1 Driver Attention Warning
- 2 System Off

Standby/Disabled



- 1 Driver Attention Warning
- 2 Standby
- 3 Last Break

Attentive driving



- 1 Attention Level
- 2 High
- 3 Last Break

Inattentive driving



- 1 Attention Level
- 2 Low
- 3 Last Break

The driver's attention level is displayed on the scale of 1 to 5. The lower the level is, the more inattentive the driver is. The level decreases when the driver does not take a break for a certain period of time. Driver Attention Warning (DAW) operates under the following conditions:

- The vehicle speed: Approximately 0~210 km/h (0~130 mph).

When the **Inattentive driving warning** is deselected from the Settings menu, **System Off** is displayed.

When vehicle speed is not within the operating speed, the message **Standby** will be displayed.

Taking a break



A: Consider taking a break

The warning message will appear on the cluster and an audible warning will sound to suggest that the driver take a break, when the driver's attention level is below 1.

Driver Attention Warning will not suggest a break when the total driving time is shorter than 10 minutes or 10 minutes has not passed after the last break was suggested.

⚠ WARNING

For your safety, change the Settings after parking the vehicle at a safe location.

⚠ CAUTION

- Driver Attention Warning may suggest a break depending on the driver's driving pattern or habits, even if the driver doesn't feel fatigued.
- Driver Attention Warning is a supplemental function and may not be able to determine whether the driver is inattentive.

- The driver who feels fatigued should take a break at a safe location, even though there is no break suggestion by Driver Attention Warning.

*** NOTICE**

- For more details on setting the instrument cluster, refer to "Instrument cluster" on page 4-41.
- Driver Attention Warning will reset the last break time to 0:00 in the following situations:
 - The vehicle is turned off
 - The driver unfastens the seat belt and opens the driver's door.
 - The vehicle is stopped for more than 10 minutes.
- When the driver resets Driver Attention Warning, the last break time is set to 0:00 and the driver's attention level is set to High.

Leading vehicle departure alert function



A: Leading vehicle is driving away

When the front vehicle departs from a stop, Leading Vehicle Departure Alert will inform the driver by displaying the warning message on the cluster and an audible warning will sound.

⚠ WARNING

- If any other function's warning message is displayed or audible warning

is generated, Leading Vehicle Departure Alert warning message may not be displayed and audible warning may not be generated.

- The driver should hold the responsibility to safely drive and control the vehicle.

⚠ CAUTION

- Leading Vehicle Departure Alert is a supplemental function and may not alert the driver whenever the front vehicle departs from a stop.
- Always check the front of the vehicle and road conditions before departure.

*** NOTICE**

The images or colours may be displayed differently depending on the specifications of the instrument cluster or theme.

Driver Attention Warning malfunction and limitations

Driver Attention Warning malfunction

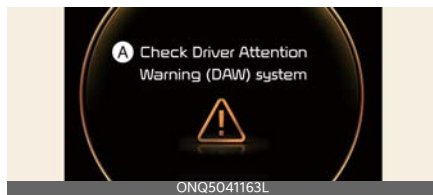

A: Check Driver Attention Warning (DAW) system

When Driver Attention Warning is not working properly, the warning message will appear and (⚠) warning lights will appear on the cluster. If this occurs, have Driver Attention Warning be inspected by a professional workshop. Kia recom-

mends visiting an authorised Kia dealer/ service partner.

Limitations of Driver Attention Warning

Driver Attention Warning may not work properly in the following situations:

- The vehicle is driven violently
- The vehicle intentionally crosses over lanes frequently
- The vehicle is controlled by Driver Assistance system, such as Lane Keeping Assist

Leading vehicle departure alert function

- When the vehicle cuts in



[A]: Your vehicle, [B]: Front vehicle

If a vehicle cuts in front of your vehicle, Leading Departure Alert may not operate properly.

- When the vehicle ahead sharply steers



[A]: Your vehicle, [B]: Front vehicle
If the vehicle in front makes a sharp turn, such as to turn left or right or make a U- turn, etc., Leading Vehicle Departure Alert may not operate properly.

- When the vehicle ahead abruptly departs

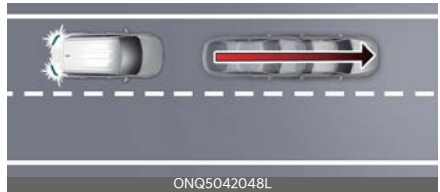

If the vehicle in front abruptly departs, Leading Vehicle Departure Alert may not operate properly.

- When a pedestrian or bicycle is between you and the vehicle ahead



If there is a pedestrian(s) or bicycle(s) in between you and the vehicle in front, Leading Vehicle Departure Alert may not operate properly.

- When in a parking lot

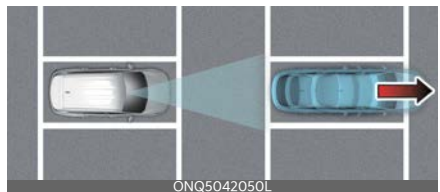

If a vehicle parked in front drives away from you, Leading Vehicle Departure Alert may warn you that the parked vehicle is driving away.

- When driving at a tollgate or intersection, etc.

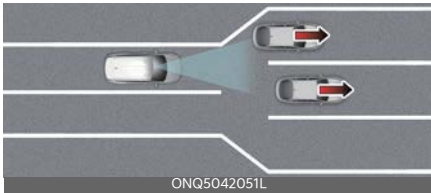

If you pass a tollgate or intersection with lots of vehicles or you drive where lanes are merged or divided frequently, Leading Vehicle Departure Alert may not operate properly.

*** NOTICE**

For more details on the limitations of the front view camera, refer to "Forward Collision-Avoidance Assist (FCA) (Front Camera Only) (if equipped)" on page 7-5.

Blind-Spot View Monitor (BVM) (if equipped)

Left side



Right side



Blind-Spot View Monitor displays the rear blind spot area of the vehicle in the cluster when the turn signal is turned on to help safely change lanes.

Detecting sensor

Wide-side view camera



(camera located at bottom of the mirror)

Refer to the picture above for the detailed location of the detecting sensors.

Blind-Spot View Monitor settings

Blind-Spot View

With the vehicle on, select **Driver assistance** → **Blind-spot safety** → **Blind-spot view** from the Settings menu to

turn on Blind-Spot View Monitor and deselect to turn off the function.

Blind-Spot View Monitor operation

Turn signal lever



Blind-Spot View Monitor will turn on and off when the turn signal is turned on and off.

Blind-Spot View Monitor

Operating conditions

- When the left or right turn signal turns on, the image on the instrument cluster will turn on.

Off conditions

Blind-Spot View Monitor will turn off when one of the following conditions are satisfied:

- When the turn signal is turned off.
- When the hazard warning flasher is on.
- When other important warning is displayed on the instrument cluster.

Blind-Spot View Monitor malfunction

When Blind-Spot View Monitor is not working properly, or the cluster display flickers, or the camera image does not display normally, have Blind-Spot View Monitor be inspected by a professional workshop. Kia recommends visiting an authorised Kia dealer/service partner.

⚠ WARNING

- The image shown on the cluster may differ from the actual distance of the object. Make sure to directly check the vehicle's surroundings for safety.
- If the camera lens is covered with foreign material, Blind-Spot View Monitor may not operate normally. Always keep the camera lens clean. However, do not use chemical solvents such as strong detergents containing high alkaline or volatile organic solvents (petrol, acetone etc.). This may damage the camera lens.

Cruise Control (CC) (if equipped)



- 1 Cruise indicator
- 2 Set speed

Cruise Control will allow you to drive at speeds above 30 km/h (20 mph) without depressing the accelerator pedal.

Cruise Control operation

To set speed

1. Accelerate to the desired speed, which must be more than 30 km/h (20 mph).



2. Press the Driving Assist (DA) button at the desired speed. The set speed and Cruise (CRUISE) indicator will appear on the cluster.
3. Release the accelerator pedal.
Set speed will maintain the set speed even when The accelerator pedal must not be pressed.

* NOTICE

On a steep sloped road, the vehicle may slightly slow down or speed up whilst driving uphill or downhill.

To increase set speed



- Push the + switch up and release it immediately. The set speed will increase by 1 km/h (1 mph) each time the switch is operated in this manner.
- Push the + switch up and hold it whilst monitoring the set speed on the cluster. The set speed will increase to the nearest multiple of ten (multiple of five in mph) at first, and then increase by 10 km/h (5 mph) each time the switch is operated in this manner. Release the switch when the desired speed is shown and the vehicle will accelerate to that speed.

To decrease set speed



- Push the - switch down and release it immediately. The set speed will decrease by 1 km/h (1 mph) each time the switch is operated in this manner.
- Push the - switch down and hold it whilst monitoring the set speed on the cluster. The set speed will decrease to the nearest multiple of ten (multiple of five in mph) at first, and then decrease by 10 km/h (5 mph) each time the switch is operated in this manner.

Release the switch at the set speed you want to maintain.

To temporarily accelerate

If you want to speed up temporarily when Cruise Control is on, depress the accelerator pedal.

To return to the set speed, take your foot off the accelerator pedal.

If you push the + switch up or - switch down at increased speed, the cruising speed will be set to the current increased speed.

To temporarily pause Cruise Control



Cruise Control will be paused when:

- Depressing the brake pedal.
- Pressing the (||) button.
- Shifting the gear to N (Neutral).
- Decreasing set speed to less than approximately 30 km/h (20 mph).
- Increasing set speed to more than approximately 190 km/h (120 mph)
- Operating the electronic parking brake system **EPB**.
- ESC (Electronic Stability Control) is operating.

The set speed will turn off but the Cruise (CRUISE) indicator will stay on.

* NOTICE

If Cruise Control pauses during a situation that is not mentioned, have the vehicle be inspected by a professional

workshop. Kia recommends visiting an authorised Kia dealer/service partner.

To resume Cruise Control



Operate the +, - switch or (||) button.

If you push the + switch up or - switch down, set speed will be set to the current speed on the cluster.

If you press the (||) button, set speed will resume to the preset speed.

Set speed must be above 30 km/h (20 mph) for Cruise Control to resume.

⚠ WARNING

Check the driving condition before using the (||) button. Driving speed may sharply increase or decrease when you press the (||) button.

To turn off Cruise Control



Press the Driving Assist (DA) button to turn Cruise Control off. The Cruise (CRUISE) indicator will go off.

Always press the Driving Assist button to turn Cruise Control off when not in use.

* NOTICE

If your vehicle is equipped with Manual Speed Limit Assist, press and hold the

Driving Assist button to turn off Cruise Control. However, Manual Speed Limit Assist will turn on.

⚠ WARNING

Take the following precautions when using Cruise Control:

- Always set the set speed under the speed limit in your country.
- Keep Cruise Control off when the function is not in use, to avoid inadvertently setting a speed. Check that the Cruise (🚗 CRUISE) indicator is off.
- Cruise Control does not substitute for proper and safe driving. It is the responsibility of the driver to always drive safely and should always be aware of unexpected and sudden situations from occurring.
- Always drive cautiously to prevent unexpected and sudden situations from occurring. Pay attention to the road conditions at all times.
- Do not use Cruise Control when it may be unsafe to keep the vehicle at a constant speed:
 - When driving in heavy traffic, or when traffic conditions make it difficult to drive at a constant speed
 - When driving on rainy, icy, or snow-covered roads
 - When driving on hilly or windy roads
 - When driving in windy areas
 - When driving with limited view (possibly due to bad weather, such as fog, snow, rain and sandstorm)
- Do not use Cruise Control when towing a trailer.

Smart Cruise Control (SCC) (if equipped)

Smart Cruise Control is designed to detect the vehicle ahead and help maintain the desired speed and minimum distance with the vehicle ahead.

Overtaking Acceleration Assist

Whilst Smart Cruise Control is operating, if the function judges that the driver is determined to overtake the vehicle in front, acceleration will be assisted.

Detecting sensor

Front view camera



Front radar



The front view camera and front radar are used as a detecting sensor to detect the vehicles in front.

Refer to the picture above for the detailed location of the detecting sensor.

⚠ CAUTION

- Always keep the front view camera and front radar in good condition to maintain optimal performance of Smart Cruise Control.

- For more details on the precautions of the front view camera and front radar, refer to "Forward Collision-Avoidance Assist (FCA) (Front Camera Only) (if equipped)" on page 7-5.

Each time the button is pressed, the vehicle distance changes as follows:

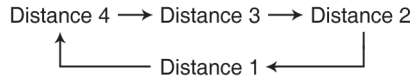

Smart Cruise Control settings

To turn on Smart Cruise Control



Press the Driving Assist () button to turn on the function. The set speed will be set to the current speed on the cluster.

- If there is no vehicle in front of you, the set speed will be maintained.
- If there is a vehicle in front of you, the set speed may be adjusted to maintain the distance to the vehicle ahead. If the vehicle ahead accelerates, your vehicle will travel at a steady cruising speed after accelerating to the set speed.

* NOTICE

If your set speed is between 0~30 km/h (0~20 mph) when you press the Driving Assist () button, the set speed will be set to 30 km/h (20 mph).

To set vehicle distance

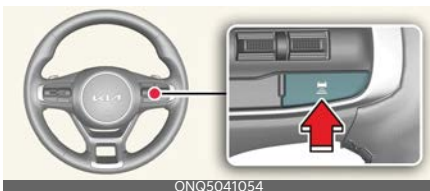

* NOTICE

- If you drive at 90 km/h (56 mph), the distance is maintained as follows:
 - Distance 4 - approximately 52.5 m (172 ft.)
 - Distance 3 - approximately 40 m (130 ft.)
 - Distance 2 - approximately 32.5 m (106 ft.)
 - Distance 1 - approximately 25 m (82 ft.)
- The distance is set to the last set distance when the vehicle is restarted, or when Smart Cruise Control was temporarily cancelled.

To increase set speed



Push the + switch up and release it immediately. The set speed will increase by 1 km/h (1 mph) each time the switch is operated in this manner.

- Push the + switch up and hold it. The set speed will increase by 10 km/h (5 mph) each time the switch is operated in this manner.
- You can increase the set speed to 180 km/h (110 mph).

⚠ WARNING

Check the driving condition before using the + switch. Driving speed may sharply increase when you push up and hold the + switch.

To decrease set speed

Push the - switch down and release it immediately. The set speed will decrease by 1 km/h (1 mph) each time the switch is operated in this manner.

- Push the - switch down and hold it. The set speed will decrease by 10 km/h (5 mph) each time the switch is operated in this manner.
- You can decrease the set speed to 30 km/h (20 mph).

To temporarily cancel Smart Cruise Control

Press the (||) switch or depress the brake pedal to temporarily cancel Smart Cruise Control.

To resume Smart Cruise Control

To resume Smart Cruise Control after the function was canceled, operate the +, - or (||) switch.

- If you push the + switch up or - switch down, set speed will be set to the current speed on the cluster.
- If you press the (||) switch, set speed will resume to the preset speed.

⚠ WARNING

Check the driving condition before using the (||) switch. Driving speed may sharply increase or decrease when you press the (||) switch.

To turn off Smart Cruise Control

Press the Driving Assist (ⓧ) button to turn Smart Cruise Control off.

*** NOTICE**

If your vehicle is equipped with Manual Speed Limit Assist, press and hold the Driving Assist (ⓧ) button to turn off Smart Cruise Control. However Manual Speed Limit Assist will turn on.

Based on Driving Mode

Smart Cruise Control will change acceleration based on the drive mode selected from Drive Mode Integrated Control function. Refer to the following chart.

| Drive Mode | Smart Cruise Control |
|------------|----------------------|
| SMART | Normal |
| ECO | Slow |
| SPORT | Fast |
| NORMAL | Normal |

* NOTICE

- For more details on Drive Mode, refer to "Drive mode integrated control system" on page 6-38.
- Smart Cruise Control may not turn on or off in some of the drive modes for the operating conditions are not satisfied.
- If your vehicle is not equipped with Drive Mode Integrated Control system, Smart Cruise Control accelerates your vehicle at a normal level.

Warning methods

Type A

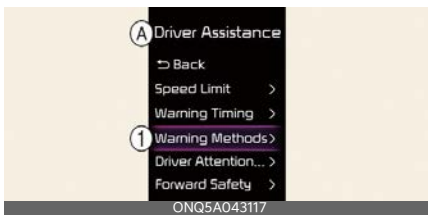

Type B

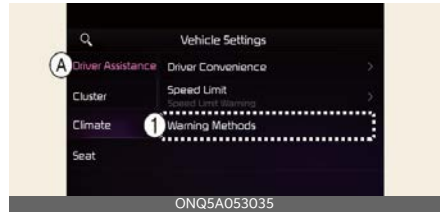

A: Driver Assistance

1 Warning Methods

The Warning Methods can be set with the vehicle on. Select **User Settings** → **Driver Assistance** → **Warning Methods** from the settings menu in the instrument cluster or **Settings** → **Vehicle** → **Driver Assistance** → **Warning Methods** from the settings menu in the infotainment system to change the following settings:

- **Warning Volume:** Adjusts the volume of the warning sound.
- **Haptic Warning:** Activate the steering wheel vibration warning. (if equipped)
- **Driving Safety Priority:** Lowers all other audio volumes when the Driving Safety system sounds a warning.

* INFORMATION

- If you change the Warning Methods, it can be applied to each function of the driver assistance system. Please check and change it in each function.
- If the vehicle is restarted, Warning Methods will maintain the last setting.
- The setting menu may not exist based on vehicle specification.
- The **Warning Volume** and **Haptic Warning** cannot be turned off at the same time. When one of the warning is turned off the other is activated.

Smart Cruise Control operation

Operating conditions

Smart Cruise Control will operate when the following conditions are satisfied.

- The gear is in D (Drive)
- The driver's door is closed
- EPB (Electronic Parking Brake) is not applied
- Your set speed is within the operating speed range
 - When there is no vehicle in front: 10~180 km/h (5~110 mph)
 - when there is a vehicle in front: 0~180 km/h (0~110 mph)
- ESC (Electronic Stability Control) or ABS is on
- ESC (Electronic Stability Control) or ABS is not controlling the vehicle
- Engine is not running at high RPM
- Forward Collision-Avoidance Assist brake control is not operating
- Remote Smart Parking Assist brake control is not operating (if equipped)

* NOTICE

When stopped behind another vehicle, the driver can turn on Smart Cruise Control whilst the brake pedal is depressed.

Overtaking Acceleration Assist

Overtaking Acceleration Assist will operate when the turn signal indicator is turned on to the left (left-hand drive) or turned on to the right (right-hand drive) whilst Smart Cruise Control is operating, and the following conditions are satisfied:

- Your set speed is above 60 km/h (40 mph)
- The hazard warning flasher is off

- A vehicle is detected in front of your vehicle
- Deceleration is not needed to maintain distance with the vehicle in front

⚠ WARNING

- When the turn signal indicator is turned on to the left (left-hand drive) or turned on to the right (right-hand drive) whilst there is a vehicle ahead, the vehicle may accelerate temporarily. Pay attention to the road conditions at all times.
- Regardless of your country's driving direction, Overtaking Acceleration Assist will operate when the conditions are satisfied. When using the function in countries with different driving direction, always check the road conditions at all times.

Smart Cruise Control display and control

Basic function

You can see the status of Smart Cruise Control operation in the Driving Assist mode on the cluster. Refer to "Instrument cluster" on page 4-41.

Smart Cruise Control will be displayed as below depending on the status of the function.

- When operating



1. Whether there is a vehicle ahead and the selected distance level are displayed.

2. Set speed is displayed.
 3. Whether there is a vehicle ahead and the selected target distance are displayed.
- When temporarily cancelled



1. (SCC) indicator is displayed.
2. The previous set speed is shaded.
3. Vehicle ahead and distance level are not displayed.

*** NOTICE**

- The distance of the front vehicle on the cluster is displayed according to the actual distance between your vehicle and the vehicle ahead.
- The target distance may vary according to the set speed and the set distance level. If set speed is low, even though the vehicle distance have changed, the change of the target vehicle distance may be small.

To temporarily accelerate



If you want to speed up temporarily without altering the set speed whilst Smart Cruise Control is operating, depress the accelerator pedal. Whilst the accelerator pedal is depressed, the set

speed, distance level and target distance will blink on the cluster.

However, if the accelerator pedal is depressed insufficiently, the vehicle may decelerate.

⚠ WARNING

Be careful when accelerating temporarily, because the speed and distance is not controlled automatically even if there is a vehicle in front of you.

Smart Cruise Control temporarily cancelled

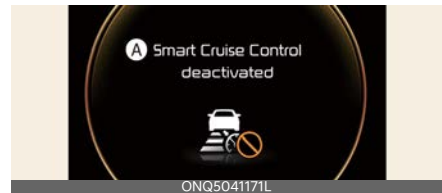

A: Smart Cruise Control deactivated

Smart Cruise Control will be temporarily cancelled automatically when:

- The set speed is above 190 km/h (120 mph)
- The vehicle is stopped for a certain period of time
- The accelerator pedal is continuously depressed for a certain period of time
- The conditions for Smart Cruise Control to operate is not satisfied

If Smart Cruise Control is temporarily cancelled automatically, a warning message will appear on the cluster, and an audible warning will sound to warn the driver.

⚠ WARNING

When Smart Cruise Control is temporarily cancelled, distance with the front vehicle will not be maintained. Always

have your eyes on the road whilst driving, and if necessary, depress the brake pedal to reduce your driving speed in order to maintain a safe distance.

Smart Cruise Control conditions not satisfied

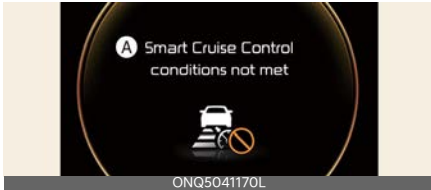

A: Smart Cruise Control conditions not met

If the Driving Assist button, + switch, - switch or (||◁) switch is operated when Smart Cruise Control's operating conditions are not satisfied, a warning message will appear on the cluster, and an audible warning will sound.

In traffic situation

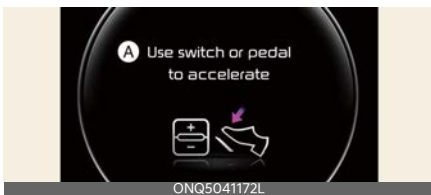

A: Use switch or pedal to accelerate

In traffic, your vehicle will stop if the vehicle ahead of you stops. Also, if the vehicle ahead of you starts moving, your vehicle will start as well.

In addition, after the vehicle has stopped and a certain time have passed, a warning message like above will appear on the cluster. Depress the accelerator pedal or operate the + switch, - switch or (||◁) switch to start driving.

Warning road conditions ahead



A: Watch for surrounding vehicles

In the following situation, the warning message will appear on the cluster, and an audible warning will sound to warn the driver of road conditions ahead.

- The vehicle in front disappears when Smart Cruise Control is maintaining the distance with the vehicle ahead whilst driving below a certain speed.
- whilst the **Use switch or pedal to accelerate** message is displayed on the cluster, if there is no vehicle in front or the vehicle is far away from you, and the + switch, - switch or (||◁) switch is pushed.

⚠ WARNING

Always pay attention to vehicles or objects that may suddenly appear in front of you, and if necessary, depress the brake pedal to reduce your driving speed in order to maintain a safe distance.

Collision warning



A: Collision Warning

Whilst Smart Cruise Control is operating, when the collision risk with the vehicle ahead is high, a warning message will appear on the cluster, an audible warning, and steering wheel vibration (if equipped) will sound to warn the driver. Always have your eyes on the road whilst driving, and if necessary, depress the brake pedal to reduce your driving speed in order to maintain a safe distance.

WARNING

In the following situations, Smart Cruise Control may not warn the driver of a collision.

- The distance from the front vehicle is near, and the vehicle speed of the front vehicle is faster or similar with your vehicle
- The speed of the front vehicle is very slow or is at a standstill
- The accelerator pedal is depressed right after Smart Cruise Control is turned on

WARNING

Take the following precautions when using Smart Cruise Control:

- Smart Cruise Control does not substitute for proper and safe driving. It is the responsibility of the driver to always check the speed and distance to the vehicle ahead.
- Smart Cruise Control may not detect unexpected and sudden situations or complex driving situations, so always pay attention to driving conditions and control your vehicle speed.
- Keep Smart Cruise Control off when the function is not in use to avoid inadvertently setting a speed.

- Do not open the door when Smart Cruise Control is operating, even if the vehicle is stopped.
- Always be aware of the selected speed and vehicle distance.
- Keep a safe distance according to road conditions and vehicle speed. If the vehicle distance is too close during high-speed driving, a serious collision may result. Always pay attention to the road condition ahead.
- When maintaining distance with the vehicle ahead, if the front vehicle disappears, the function may suddenly accelerate to the set speed. Always be aware of unexpected and sudden situations from occurring.
- Set speed may decrease on an upward sloped road and increase on a downward sloped road.
- Always be aware of situations such as when a vehicle cuts in suddenly.
- When you are towing a trailer or another vehicle, we recommend that Smart Cruise Control is turned off due to safety reasons.
- Turn off Smart Cruise Control when your vehicle is being towed.
- Smart Cruise Control may be cancelled if interfered by strong electromagnetic waves.
- Smart Cruise Control may not detect an obstacle in front and lead to a collision. Always look ahead cautiously to prevent unexpected and sudden situations from occurring.
- Vehicles moving in front of you with a frequent lane change may cause a delay in the function's reaction or may cause the function to react to a vehicle actually in an adjacent lane. Always drive cautiously to prevent

unexpected and sudden situations from occurring.

- Always be aware of the surroundings and drive safely, even though a warning message does not appear or an audible warning does not sound.
- If any other function's warning message is displayed or warning sound is generated, Smart Cruise Control warning message may not be displayed and warning sound may not be generated.
- You may not hear the warning sound of Smart Cruise Control if the surrounding is noisy. Always pay attention to the road condition ahead.
- The vehicle manufacturer is not responsible for any traffic violation or accidents caused by the driver whilst Smart Cruise Control is operating.
- Always set the set speed under the speed limit in your country.

*** NOTICE**

- Smart Cruise Control may not operate for 15 seconds after the vehicle is restarted or the front view camera or front radar is initialized.
- You may hear a sound when the brake is controlled by Smart Cruise Control.

*** NOTICE**

The images or colours may be displayed differently depending on the specifications of the instrument cluster or theme.

Smart Cruise Control malfunction and limitations

Smart Cruise Control malfunction



A: Check Smart Cruise Control System

When Smart Cruise Control is not working properly, a warning message will appear, and the (⚠) warning light will appear on the cluster. Have Smart Cruise Control be inspected by a professional workshop. Kia recommends visiting an authorised Kia dealer/service partner.

Smart Cruise Control disabled

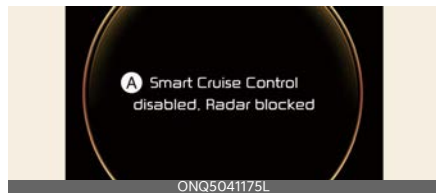

A: Smart Cruise Control disabled. Radar blocked

When the front radar cover or sensor is covered with snow, rain, or foreign material, it can reduce the detecting performance and temporarily limit or disable Smart Cruise Control.

If this occurs, a warning message will appear on the cluster.

Smart Cruise Control will operate normally when snow, rain or foreign material is removed.

⚠ WARNING

Even though the warning message does not appear on the cluster, Smart Cruise Control may not properly operate.

⚠ CAUTION

Smart Cruise Control may not properly operate in an area (e.g. open terrain), where there is nothing to detect after turning ON the vehicle.

Limitations of Smart Cruise Control

Smart Cruise Control may not operate normally under the following circumstances:

- The detecting sensor or the surroundings are contaminated or damaged
- Washer fluid is continuously sprayed, or the wiper is on
- The camera lens is contaminated due to tinted, filmed or coated windscreen, damaged glass, or stuck of foreign material (sticker, bug, etc.) on the glass
- Moisture is not removed or frozen on the windscreen
- The field of view of the front view camera is obstructed by sun glare
- Street light or light from an oncoming vehicle is reflected on the wet road surface, such as a puddle on the road
- The temperature around the front view camera is high or low
- An object is placed on the instrument panel
- The surrounding is very bright
- The surrounding is very dark, such as in a tunnel, etc.
- The brightness changes suddenly, for example when entering or exiting a tunnel
- The brightness outside is low, and the headlamps are not on or are not bright
- Driving in heavy rain or snow, or thick fog
- Driving through steam, smoke or shadow
- Only part of the vehicle is detected
- The vehicle in front has no tail lights, tail lights are located unusually, etc.
- The brightness outside is low, and the tail lamps of the vehicle in front are not on or are not bright
- The rear of the front vehicle is small or does not look normal (i.e. tilted, overturned, etc.)
- The front vehicle's ground clearance is low or high
- A vehicle suddenly cuts in front
- Your vehicle is being towed
- Driving through a tunnel or iron bridge
- Driving near areas containing metal substances, such as a construction zone, railroad, etc.
- A material is near that reflects very well on the front radar, such as a guardrail, nearby vehicle, etc.
- The bumper around the front radar is impacted, damaged or the front radar is out of position
- The temperature around the front radar is high or low
- Driving in large areas where there are few vehicles or structures (i.e. desert, meadow, suburb, etc.)

- The vehicle in front is made of material that does not reflect on the front radar
- Driving near a highway (or motorway) interchange or tollgate
- Driving on a slippery surface due to snow, water puddle, ice, etc.
- Driving on a curved road
- The vehicle in front is detected late
- The vehicle in front is suddenly blocked by an obstacle
- The vehicle in front suddenly changes lane or suddenly reduces speed
- The vehicle in front is bent out of shape
- The front vehicle's speed is fast or slow
- With a vehicle in front, your vehicle changes lane suddenly at low speed
- The vehicle in front is covered with snow
- Unstable driving
- You are on a roundabout and the vehicle in front is not detected
- You are continuously driving in a circle
- Driving in a parking lot
- Driving through a construction area, unpaved road, partial paved road, uneven road, speed bumps, etc.
- Driving on an incline road, curved road, etc.
- Driving through a roadside with trees or streetlights
- The adverse road conditions cause excessive vehicle vibrations whilst driving
- Your vehicle height is low or high due to heavy loads, abnormal tyre pressure, etc.

- Driving through a narrow road where trees or grass are overgrown
- There is interference by electromagnetic waves, such as driving in an area with strong radio waves or electrical noise
- Driving on a curved road



On curved roads, Smart Cruise Control may not detect a vehicle in the same lane, and may accelerate to the set speed. Also, set speed may rapidly decrease when the vehicle ahead is detected suddenly.

Select the appropriate set speed on curved roads and apply the brake pedal or accelerator pedal according to the road and driving conditions ahead.



Your set speed can be reduced due to a vehicle in the adjacent lane.

Check to be sure that the road conditions permit safe operation of Smart Cruise Control and if necessary, depress the brake pedal to reduce your driving speed in order to maintain a safe distance.

- Driving on a inclined road



During uphill or downhill driving, Smart Cruise Control may not detect a moving vehicle in your lane, and cause your vehicle to accelerate to the set speed. Also, set speed will rapidly decrease when the vehicle ahead is detected suddenly.

Select the appropriate set speed on sloped roads and apply the brake pedal or accelerator pedal according to the road and driving conditions ahead.

- Changing lanes



[A]: Your vehicle

[B]: Lane changing vehicle

When a vehicle moves into your lane from an adjacent lane, it cannot be detected by the sensor until it is in the sensor's detection range. Smart Cruise Control may not immediately detect the vehicle when the vehicle changes lanes abruptly. Always pay

attention to the road and driving conditions and drive safely. If necessary, depress the brake pedal to reduce your driving speed in order to maintain a safe distance.

- Detecting a vehicle



In the following cases, some vehicles in your lane cannot be detected by the sensor:

- Vehicles offset to one side
- Slow-moving vehicles or sudden-decelerating vehicles
- Vehicles that has the front lifted due to heavy loads
- Oncoming vehicles
- Stopped vehicles
- Vehicles with small rear profile, such as trailers
- Narrow vehicles, such as motorcycles or bicycles
- Special vehicles
- Animals and pedestrians
- Vehicle at a short distance (about 2m)



In the following cases, the vehicle in front cannot be detected by the sensor. Always pay attention to the road and driving conditions and drive safely. If necessary, adjust your set speed.

- Vehicles with higher ground clearance or vehicles carrying loads that stick out of the back of the vehicle
- Vehicles that has the front lifted due to heavy loads
- You are steering your vehicle
- Driving on narrow or sharply curved roads



- When a vehicle ahead disappears at an intersection, your vehicle may accelerate.
Always pay attention to road and driving conditions whilst driving.



- When a vehicle in front of you merges out of the lane, Smart Cruise Control may not immediately detect the new vehicle that is now in front of you. Always pay attention to road and driving conditions whilst driving.



- Always look out for pedestrians when your vehicle is maintaining a distance with the vehicle ahead.

Lane Following Assist (LFA) (if equipped)

Lane Following Assist is designed to help detect lane markings and/or vehicles on the road, and assists the driver's steering to help keep the vehicle between lanes.

Detecting sensor

Front view camera



The front view camera is used as a detecting sensor to detect lane markings and front vehicles.

Refer to the picture above for the detailed location of the detecting sensor.

CAUTION

For more details on the precautions of the front view camera, refer to "Forward Collision-Avoidance Assist (FCA) (Front Camera Only) (if equipped)" on page 7-5.

Lane Following Assist settings

Turning Lane Following Assist On/Off



With the vehicle on, shortly press the Lane Driving Assist button located on

the steering wheel to turn on Lane Following Assist. The gray or green (LFA icon) indicator light will appear on the cluster. Press the button again to turn off the function.

Warning methods

Type A

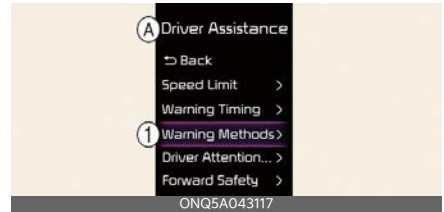

Type B

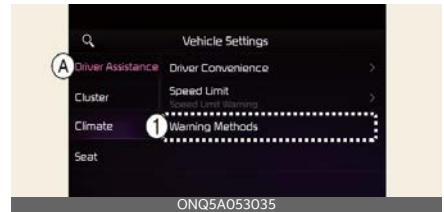

A: Driver Assistance

1 Warning Methods

The Warning Methods can be set with the vehicle on. Select **User Settings** → **Driver Assistance** → **Warning Methods** from the settings menu in the instrument cluster or **Settings** → **Vehicle** → **Driver Assistance** → **Warning Methods** from the settings menu in the infotainment system to change the following settings:

- **Warning Volume:** Adjusts the volume of the warning sound.
- **Driving Safety Priority:** Lowers all other audio volumes when the Driving Safety system sounds a warning.

* INFORMATION

- If you change the Warning Methods, it can be applied to each function of the driver assistance system. Please check and change it in each function.
- If the vehicle is restarted, Warning Methods will maintain the last setting.
- The setting menu may not exist based on vehicle specification.

Lane Following Assist operation Warning and control

Lane Following Assist



If the vehicle ahead and/or both lane markings are detected and your vehicle speed is below 180 km/h (110 mph), Lane Following Assist will help centre the vehicle in the lane by assisting the steering wheel. The green (A) indicator light will appear on the cluster.

⚠ CAUTION

When the steering wheel is not assisted, the white (A) indicator light will blink and change to grey.

Hands-off warning

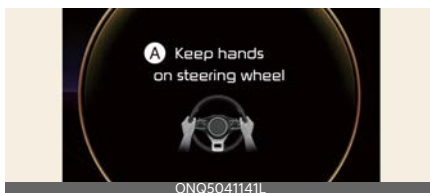

A: Keep hands on steering wheel

If the driver takes their hands off the steering wheel for several seconds, the warning message will appear and an audible warning will sound in stages.

- First stage: Warning message
- Second stage: Warning message (red steering wheel) and audible warning

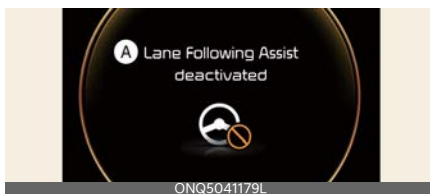

A: Lane Following Assist deactivated

If the driver still does not have their hands on the steering wheel after the hands-off warning, the warning message will appear and Lane Following Assist will be automatically cancelled.

⚠ WARNING

- The steering wheel may not be assisted if the steering wheel is held very tight or the steering wheel is steered over a certain degree.
- Lane Following Assist does not operate at all times. It is the responsibility of the driver to safely steer the vehicle and to maintain the vehicle in its lane.
- The hands-off warning message may appear late depending on road conditions. Always have your hands on the steering wheel whilst driving.

- If the steering wheel is held very lightly the hands-off warning message may appear because Lane Following Assist may not detect that the driver has their hands on the steering wheel.
- If you attach objects to the steering wheel, the hands-off warning may not work properly.

*** NOTICE**

- For more details on setting Lane Following Assist in the infotainment system, refer to Navigation Quick Reference Guide.
- When both lane markings are detected, the lane lines on the cluster will change from grey to white.

Lane undetected



Lane detected



- The images and colours in the cluster may differ depending on the cluster type or theme selected from the cluster.
- If lane markings are not detected, steering wheel control by Lane Following Assist can be limited depend-

ing on whether a vehicle is in front or the driving conditions of the vehicle.

- Even though the steering is assisted by Lane Following Assist, the driver may control the steering wheel.
- The steering wheel may feel heavier or lighter when the steering wheel is assisted by Lane Following Assist than when it is not.

Lane Following Assist malfunction and limitations

Lane Following Assist malfunction

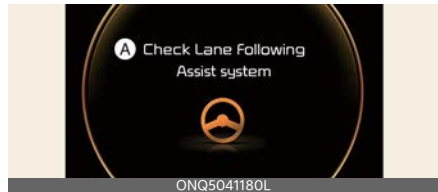

A: Check Lane Following Assist system

When Lane Following Assist is not working properly, the warning message will appear and the master warning light (⚠️) will appear on the cluster. If this occurs, have Lane Following Assist be inspected by a professional workshop. Kia recommends visiting an authorised Kia dealer/service partner.

Limitations of Lane Following Assist

For more details on Lane Following Assist limitations, refer to "Lane Keeping Assist (LKA) (if equipped)" on page 7-26.

⚠️ WARNING

For more details on Lane Following Assist precautions, refer to "Lane Keeping Assist (LKA) (if equipped)" on page 7-26.

Rear View Monitor (RVM) (if equipped)



Rear View Monitor will show the area behind the vehicle to assist you when parking or Reversing.

* NOTICE

If the Display Audio or additional infotainment system (Kia Genuine Parts) is installed, the instructions for the rear view monitor may differ from those in the owner's manual. In this case, access the web manual using the QR code in the infotainment system quick reference guide.

Detecting sensor

Rear view camera



Refer to the picture above for the detailed location of the detecting sensor.

Rear View Monitor settings

Camera settings



With the vehicle on, select the setup icon (⚙️) on the screen or **Settings** → **Vehicle** → **Driver assistance** → **Parking safety** → **Camera settings** from the infotainment system screen to change the Rear View Monitor settings.

- Display Contents: To change the settings of Extended Rear View Monitor and Rear View Parking Guidance Lines.
- Display Settings: To change the screen's brightness and contrast. (if equipped)

* NOTICE

- The horizontal guideline shows the distance of 0.5 m (1.6 ft.), 1 m (3.3 ft.) and 2.3 m (7.6 ft.) from the vehicle.
- The horizontal scale of rear top view parking guide indicates the tailgate opening distance, 1.5 m from the vehicle.

Warning methods

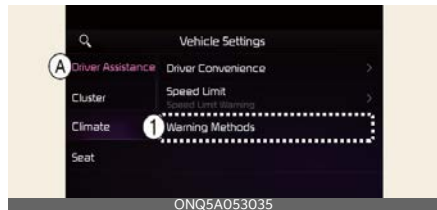

A: Driver Assistance

1 Warning Methods

The Warning Methods can be set with the vehicle on. Select **Settings** → **Vehicle** → **Driver Assistance** → **Warning Methods** from the settings menu in the infotainment system to change the following settings:

- **Parking Safety Priority:** Lowers all other audio volumes when Rear View Monitor is active.

* INFORMATION

- If you change the Warning Methods, it can be applied to each function of the driver assistance system. Please check and change it in each function.
- If the vehicle is restarted, Warning Methods will maintain the last setting.
- The setting menu may not exist based on vehicle specification.

Rear View Monitor operation

Parking/View button



Press the Parking/View button (1) to turn on or off Rear View Monitor.

Rear view



Operating conditions

Rear View Monitor will turn on when the following conditions are satisfied:

- Shifting the gear to R (Reverse).
- Pressing the Parking/View button (1) whilst P (Park) gear position is selected
- Pressing the View icon with the Rear top view on the screen

Off conditions

Rear View Monitor will turn off when the following conditions are satisfied:

- Pressing the Parking/View button (1) again whilst P (Park) gear position is selected, with the rear view on the screen.
- Changing the gear from R (Reverse) to P (Park).

* NOTICE

The rear view cannot be turned off when the gear is in R (Reverse).

Extended Rear View Monitor function

Extended rear view function maintains the rear view of the vehicle when shifting the gear from R (Reverse) to N (Neutral) or D (Drive) to help you park safely.

Operating conditions

Rear View Monitor will maintain when the following conditions are satisfied:

- Shifting the gear from R (Reverse) to N (Neutral) or D (Drive).
- The vehicle speed is below approximately 10 km/h (6 mph).

Off conditions

Extended rear view function will turn off when one of the following conditions are satisfied:

- The vehicle speed is above approximately 10 km/h (6 mph).
- Pressing the Parking/View button (1).
- Shifting the gear to P (Park).

Rear view whilst driving

The driver is able to check the rear view on the screen whilst driving, it is to assist with safe driving.

Operating conditions

Press the Parking/View button (1) whilst the gear is in D (Drive) or N (Neutral), rear view whilst driving will appear on the screen.

Off conditions

Rear view whilst driving function will turn off when one of the following conditions are satisfied:

- Pressing the Parking/View button (1) or the infotainment system button.
- Shifting the gear to P (Park).

Rear top view



Rear top view shows the distance from the vehicle or the object in the back of your vehicle whilst parking.

Press the Rear top view button to turn on Rear top view.

Rear View Monitor malfunction and limitations

Rear View Monitor malfunction

When Rear View Monitor is not working properly, or the screen flickers, or the camera image does not display normally, Kia recommends visiting an authorised Kia dealer/service partner.

Limitations of Rear View Monitor

⚠ WARNING

- The rear view camera does not cover the complete area behind the vehicle. The driver should always check the rear area directly through the inside and outside rear view mirror before parking or Reversing.
- The image shown on the screen may differ from the actual distance of the object. Make sure to directly check the vehicle's surroundings for safety.
- Always keep the rear view camera lens clean. If the lens is covered with foreign material, it may adversely affect camera performance and Rear View Monitor may not operate normally. However, do not use chemical solvents such as strong detergents containing high alkaline or volatile organic solvents (petrol, acetone etc.). This may damage the camera lens.

Surround View Monitor (SVM) (if equipped)



Surround View Monitor can assist in parking by allowing the driver to see around the vehicle.

* NOTICE

If the additional infotainment system (Kia Genuine Parts) is installed, the instructions for the rear view monitor may differ from those in the owner's manual. In this case, access the web manual using the QR code in the infotainment system quick reference guide.

Detecting sensor



- 1: Wide-front view camera
- 2, 3: Wide-side view camera (under the Outside rear view mirror)
- 4: Wide-rear view camera

Refer to the picture above for the detailed location of the detecting sensors.

Surround View Monitor settings

Camera settings



With the vehicle on, select the setup icon (⚙️) on the screen or **Settings** → **Vehicle** → **Driver assistance** → **Parking safety** → **Camera settings** from the infotainment system screen to change the Rear View Monitor settings.

- Display Contents: To change the settings of **Parking distance warning**, **Top view parking guide lines**, and **Rear view parking guide lines** function.
- Display Settings: To change the screen's brightness and contrast. (if equipped)

* NOTICE

The settings menu on your vehicle may not be necessarily be available due to the selected options or regions.

Warning methods

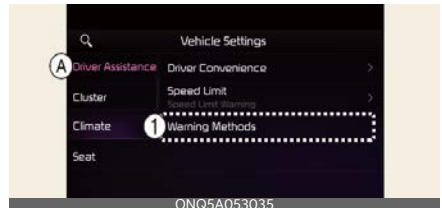

A: Driver Assistance

1 Warning Methods

The Warning Methods can be set with the vehicle on. Select **Settings** → **Vehicle** → **Driver Assistance** → **Warning Methods** from the settings menu in the infotainment system to change the following settings:

- **Parking Safety Priority:** Lowers all other audio volumes when Surround View Monitor is active is active.

* INFORMATION

- If you change the Warning Methods, it can be applied to each function of the driver assistance system. Please check and change it in each function.
- If the vehicle is restarted, Warning Methods will maintain the last setting.
- The setting menu may not exist based on vehicle specification.

Surround View Monitor Auto On

With the vehicle on, select 'Driver Assistance → Parking Safety → Surround View Monitor Auto On' from the infotainment system Settings menu to use the function.

* NOTICE

To use this function, refer to "Surround View Monitor operation" on page 7-91

Top View Parking Guidance

Front top view



Rear top view



Parking guidance is displayed on the right side of the Surround View Monitor screen when the **Front or Rear Top View Parking Guidance** is selected.

Rear View Parking Guidance

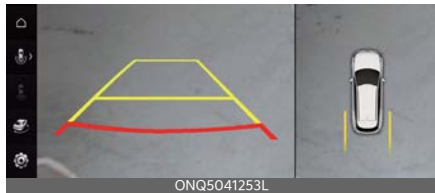

Rear view parking guidance is displayed in the rear view when the **Parking guide in rear view** is selected.

* NOTICE

- The horizontal guideline of the Rear View Parking Guidance shows the distance of 0.5 m (1.6 ft.), 1 m (3.3 ft.) and 2.3 m (7.6 ft.) from the vehicle.
- The horizontal scale of rear top view parking guide indicates the tailgate opening distance, 2 m from the vehicle.

Parking Distance Warning



Parking distance warning is displayed on the right side of the Surround View Monitor top view screen when the **Parking distance warning** is selected.

Surround View Monitor Auto On

With the vehicle on, select **Settings** → **Vehicle** → Driver assistance → **Parking safety** → **Surround view monitor auto On** from the infotainment system screen to use the function.

* NOTICE

For more details on Surround View Monitor Auto On, refer to "Surround View Monitor Auto On" on page 7-91.

Surround View Monitor operation

Parking/View button



Press the Parking/View button (1) to turn on or off Surround View Monitor.

Front view



Front view function is displayed on the screen when the gear is in N (Neutral) or D (Drive) to assist in parking. The front view has a top view, front view, and side view. Also, other view modes can be selected by pressing the view icons (2) on the Surround View Monitor screen.

Operating conditions

Front view function will turn on when the following conditions are satisfied:

- Shifting from R (Reverse) to N (Neutral) or D (Drive) and the vehicle speed is below approximately 10 km/h (6 mph).
- Pressing the Parking/View button (1) when the gear is in D (Drive) or N (Neutral) and vehicle speed is below 10 km/h (6 mph).
- Forward Parking Distance Warning warns the driver whilst driving in D (Drive) (**Driver assistance** → **Parking safety** → **Surround view monitor auto On** selected from the Settings menu)

Off conditions

Front view function will turn off when the following conditions are satisfied:

- Press the Parking/View button (1) or the infotainment system button (3).
- When vehicle speed is above 10 km/h (6 mph).
- Press one of the infotainment system button (3), the screen will change to the infotainment system screen.
- Shifting to P (Park).

* NOTICE

If Surround View Monitor is turned off after driving more than 10 km/h (6 mph), driving below 10 km/h (6 mph) again will not switch to the Surround View Monitor screen.

Rear view

Rear view function is displayed on the screen when the gear is in R (Reverse) or P (Park) to assist in parking. The rear view has a top view, rear view, and side

view. Also, other view modes can be selected by pressing the view icons on the Surround View Monitor screen.

Operating conditions

Rear view function will turn on when the following conditions are satisfied:

- Shifting to R (Reverse).
- Pressing the Parking/View button (1) when P (Park) gear position is selected.

Off conditions

Rear view function will turn off when the following conditions are satisfied:

- Shifting from R (Reverse) to P (Park).
- Pressing the Parking/View button (1) when P (Park) gear position is selected.

* NOTICE

Pressing the infotainment system button (3) will not turn the rear view off when the gear is in R (Reverse).

Rear view whilst driving

The driver is able to check the rear view on the screen whilst driving, it is to assist with safe driving.

Operating conditions

Rear view whilst driving function will turn on when the following conditions are satisfied:

- Pressing the Parking/View button (1) when the vehicle speed is above 10 km/h (6 mph).
- Pressing the view icon on the Surround View Monitor screen when the vehicle speed is below 10 km/h (6 mph).

Off conditions

Rear view whilst driving function will turn off when the following conditions are satisfied:

- Pressing the Parking/View button (1) or the infotainment system button (3).
- Shifting to P (Park).
- Pressing the other view icon on the Surround View Monitor screen when the vehicle speed is below 10 km/h (6 mph).

3D view function

3D view function shows the vehicle in various angles. Press the 3D view icon on the Surround View Monitor screen to choose the angle. Press the 3D view icon again to reset the angle.

Operating conditions

3D view function will turn on when the following conditions are satisfied:

- Shifting to P (Park), N (Neutral) or D (Drive) and the vehicle speed is below 10 km/h (6 mph).
- When shifting to R (Reverse) and Surround View Monitor is on, Press 3D view icon on the Surround View Monitor screen.

Off conditions

3D view function will turn off when the following conditions are satisfied:

- Vehicle in P (Park), N (Neutral) or D (Drive)
 - Shifting to P (Park)
 - Pressing the Parking/View button (1)
 - Pressing the infotainment screen button (3)

- Pressing the home button on the Surround View Monitor screen (2)
- Vehicle speed is above 10 km/h (6 mph)
- Vehicle in R (Reverse)
 - Shifting to P (Park)

* NOTICE

3D view function does not display the parking guide.

Surround View Monitor malfunction and limitations

Surround View Monitor malfunction

When Surround View Monitor is not working properly, or the screen flickers, or the camera image does not display normally, Kia recommends visiting an authorised Kia dealer/service partner.

Limitations of Surround View Monitor

- The screen may be displayed abnormally, and an icon will appear at the top left side of the screen under the following circumstances:
 - The tailgate is opened.
 - The driver or front passenger door is opened.
 - The outside rear view mirror is folded.

▲ WARNING

- ALWAYS look around your vehicle to make sure there are no objects or obstacles before moving the vehicle. What you see on the screen may differ from the actual vehicle's location.
- The image shown on the screen may differ from the actual distance of the

object. Make sure to directly check the vehicle's surroundings for safety.

- Surround View Monitor is designed to be used on a flat surface. Therefore, if used on roads with different heights such as kerbs and speed bumps, the image in the screen may not look correct.
- Always keep the camera lens clean. If the lens is covered with foreign material, it may adversely affect camera performance and Surround View Monitor may not operate normally. However, do not use chemical solvents such as strong detergents containing high alkaline or volatile organic solvents (petrol, acetone etc.). This may damage the camera lens.

* NOTICE

- When Rear View whilst Driving is on, it stays on whilst driving regardless of vehicle speed.
- When Rear View whilst Driving is on whilst Reversing, the screen changes to the rear view.

Rear Cross-Traffic Collision Warning (RCCW) (if equipped)

Rear Cross-Traffic Collision Warning is designed to help detect vehicles approaching from blind spot area whilst your vehicle is reversing, and warn the driver that a collision is imminent with a warning message and an audible warning.



[A]: Rear Cross-Traffic Collision Warning operating range

⚠ CAUTION

The time of warning may vary depending on vehicle speed of the approaching vehicle.

Detecting sensor

Rear corner radar



Refer to the picture above for the detailed location of the detecting sensor.

⚠ CAUTION

For more details on the precautions of the rear corner radar, refer to "Blind-Spot Collision-Avoidance Assist (BCA) (if equipped)" on page 7-39.

Rear Cross-Traffic Collision Warning settings

Rear Cross-Traffic Safety

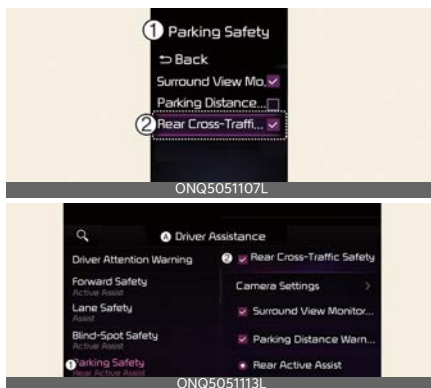

A: Driver assistance

- 1 Parking safety
- 2 Rear Cross-Traffic Safety
- 3 Off

With the engine on, select 'Driver Assistance → Parking Safety → Rear Warning Only' from the Settings menu to turn on Rear Cross-Traffic Collision Warning and deselect to turn off the function.

⚠ WARNING

When the engine is restarted, Rear Cross-Traffic Collision Warning will automatically turn on. However, if 'Off' is selected after the engine is restarted, the driver should always be aware of the surroundings and drive safely.

Warning Timing

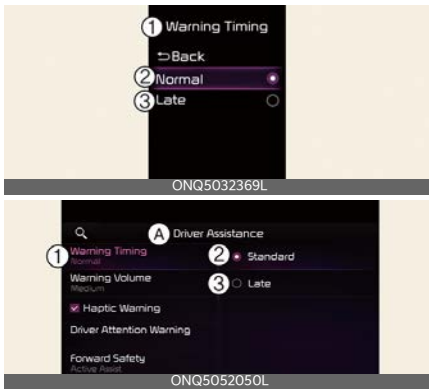

A: Driver assistance

1 Warning timing

2 Normal

3 Late

With the engine on, select 'Driver Assistance → Warning Timing' to change the Settings for Rear Cross-Traffic Collision-Avoidance Warning. You can set the warning point to 'Normal' or 'Late'.

- Normal: Use in a typical driving environment. Select 'Late' if the Warning Timing feels too sensitive.

* NOTICE

If you change the Warning Timing, the warning time of other Driver Assistance systems may change.

Warning methods

Type A

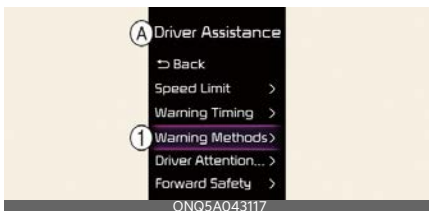

Type B

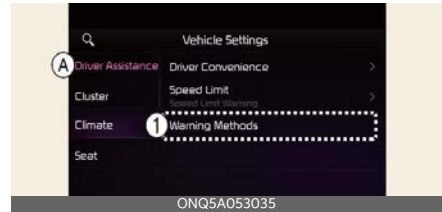

A: Driver Assistance

1 Warning Methods

The Warning Methods can be set with the vehicle on. Select **User Settings** → **Driver Assistance** → **Warning Methods** from the settings menu in the instrument cluster or **Settings** → **Vehicle** → **Driver Assistance** → **Warning Methods** from the settings menu in the infotainment system to change the following settings:

- **Warning Volume:** Adjusts the volume of the warning sound.
- **Haptic Warning:** Activate the steering wheel vibration warning. (if equipped)

* INFORMATION

- If you change the Warning Methods, it can be applied to each function of the driver assistance system. Please check and change it in each function.
- If the vehicle is restarted, Warning Methods will maintain the last setting.
- The setting menu may not exist based on vehicle specification.

Rear Cross-Traffic Collision Warning operation

Warning

Rear Cross-Traffic Collision Warning will warn and control the vehicle depending on collision level

- Collision Warning

Collision warning



- To warn the driver of an approaching vehicle from the rear left/right side of your vehicle, the warning light on the outside rearview mirror will blink and a warning will appear on the cluster. At the same time, an audible warning will sound. If the Rear View Monitor is operating, a warning will also appear on the infotainment system screen. (if equipped)
- Rear Cross-Traffic Collision Warning will operate when all the following conditions are satisfied:
 - The gear is shifted to R (Reverse) and the vehicle speed is below 8 km/h (5 mph)
 - The approaching vehicle is within approximately 25 m (82 ft.) from the blind spot area of your vehicle

- The speed of the vehicle approaching from the blind spot area is above 5 km/h (3 mph)

*** NOTICE**

- If the operating conditions are satisfied, there will be a warning whenever the vehicle approaches from the blind spot area.
- Depending on the instrument cluster specifications or theme, images or colours may be displayed differently.

⚠ WARNING

- For your safety, set the Settings after parking the vehicle at a safe location.
- If any other function's warning message is displayed or audible warning is generated, Rear Cross-Traffic Collision Warning's warning message may not be displayed and audible warning may not be generated.
- You may not hear the warning sound of Rear Cross-Traffic Collision Warning if the surrounding is noisy. Adjust the volume inside the vehicle appropriately be aware of the surroundings and drive safely.
- Rear Cross-Traffic Collision Warning does not operate in all situations or cannot avoid all collisions.
- The driver should hold the responsibility to control the vehicle. Do not solely depend on Rear Cross-Traffic Collision Warning. Rather, maintain a safe braking distance, and if necessary, depress the brake pedal to reduce driving speed or to stop the vehicle.
- Never deliberately operate Rear Cross-Traffic Collision Warning on

people, animal, objects, etc. It may cause serious injury or death.

Rear Cross-Traffic Collision Warning malfunction and limitations

Rear Cross-Traffic Collision Warning malfunction

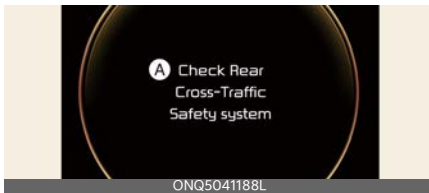

A: Check Rear Cross-Traffic Safety system

When Rear Cross-Traffic Collision Warning is not working properly, the warning message will appear and the master warning light (A) will appear on the cluster, and Rear Cross-Traffic Collision Warning will turn off automatically or Rear Cross-Traffic Collision Warning will be limited. Have Rear Cross-Traffic Collision Warning be inspected by a professional workshop. Kia recommends to visit an authorised Kia dealer/service partner.

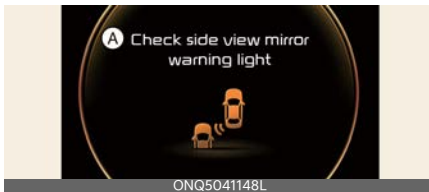

A: Check side view mirror warning light

When the outside rearview mirror warning light is not working properly, the warning message will appear and the master warning light (A) will appear on the cluster. Have Rear Cross-Traffic Col-

lision Warning be inspected by a professional workshop. Kia recommends to visit an authorised Kia dealer/service partner.

Rear Cross-Traffic Collision Warning disabled

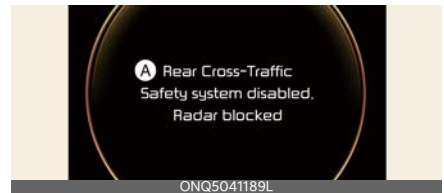

A: Rear Cross-Traffic Safety system disabled. Radar blocked

When the rear bumper around the rear corner radar or rear sensor is covered with foreign material, such as snow or rain, or installing a trailer or carrier, it can reduce the detecting performance and temporarily limit or disable Rear Cross-Traffic Collision Warning.

If this occurs, the 'Rear Cross-Traffic Safety system disabled. Radar blocked' (or 'Rear cross-traffic safety functions disabled. Radar blocked') warning message will appear on the cluster. But it is not Rear Cross-Traffic Collision Warning malfunction.

Rear Cross-Traffic Collision Warning will operate normally when such foreign material or trailer, etc. is removed. Always keep it clean.

If Rear Cross-Traffic Collision Warning does not operate normally after it is removed, have Rear Cross-Traffic Collision Warning be inspected by a professional workshop. Kia recommends to visit an authorised Kia dealer/service partner.

⚠ WARNING

- Even though the warning message or warning light does not appear on the cluster, Rear Cross-Traffic Collision Warning may not operate properly.
- Rear Cross-Traffic Collision Warning may not operate properly in an area or contaminated (for example: open terrain), where any substance are not detected after turning ON the engine.

⚠ CAUTION

Turn off Rear Cross-Traffic Collision Warning to install a trailer, carrier, etc., or remove the trailer, carrier, etc. to use Rear Cross-Traffic Collision Warning.

Limitations of Rear Cross-Traffic Collision Warning

Rear Cross-Traffic Collision Warning may not operate normally, or Rear Cross-Traffic Collision Warning may operate unexpectedly under the following circumstances:

- Departing from where trees or grass are overgrown
- Departing from where roads are wet
- Speed of the approaching vehicle is fast or slow

⚠ CAUTION

For more details on the limitations of the rear corner radar, refer to "Blind-Spot Collision-Avoidance Assist (BCA) (if equipped)" on page 7-39.

⚠ WARNING

- Driving near a vehicle or structure



[A]: Structure

Rear Cross-Traffic Collision Warning may be limited when driving near a vehicle or structure, and may not detect the vehicle approaching from the blind spot area. If this occurs, Rear Cross-Traffic Collision Warning may not warn the driver when necessary.

Always check your surroundings whilst backing up.

- When the vehicle is in a complex parking environment



Rear Cross-Traffic Collision Warning may detect vehicles which are parking or pulling out near your vehicle (for example: a vehicle leaving beside your vehicle, a vehicle parking or pulling out in the rear area, a vehicle approaching your vehicle making a turn, etc.). If this occurs, Rear Cross-Traffic Collision Warning may unnecessarily warn the driver.

Always check your surroundings whilst backing up.

- When the vehicle is parked diagonally



[A]: Vehicle

Rear Cross-Traffic Collision Warning may be limited when backing up diagonally, and may not detect the vehicle approaching from the blind spot area. If this occurs, the function may not warn the driver when necessary. Always check your surroundings whilst backing up.

- When the vehicle is on or near a sloped road



Rear Cross-Traffic Collision Warning may be limited when the vehicle is on a uphill or downhill sloped road, or near it, and may not detect the vehicle approaching from the blind spot area. If this occurs, Rear Cross-Traffic Collision Warning may not warn the driver when necessary.

Always check your surroundings whilst backing up.

⚠ WARNING

- Pulling into the parking space where there is a structure



[A]: Structure, [B]: Wall

Rear Cross-Traffic Collision Warning may detect vehicles passing by in front of you when parking backwards into a parking space with a wall or structure in the rear or side area. If this occurs, Rear Cross-Traffic Collision Warning may unnecessarily warn the driver.

Always check your surroundings whilst backing up.

- When the vehicle is parked backward

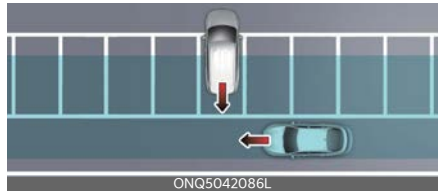

Rear Cross-Traffic Collision Warning may detect vehicles passing by behind you when parking backwards into a parking space. If this occurs, Rear Cross-Traffic Collision Warning may unnecessarily warn the driver.

Always check your surroundings whilst backing up.

⚠ WARNING

- Rear Cross-Traffic Collision Warning may not operate suddenly if interfered by strong electromagnetic waves.
- Rear Cross-Traffic Collision Warning may not operate for 3 seconds after the vehicle is started, or the rear corner radars are initialized.

Rear Cross-Traffic Collision-Avoidance Assist (RCCA) (if equipped)

Rear Cross-Traffic Collision-Avoidance Assist is designed to help detect vehicles approaching from blind spot area whilst your vehicle is reversing, and warn the driver that a collision is imminent with a warning message and an audible warning. Also, braking is assisted to help prevent collision.

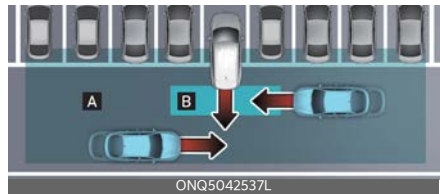

[A]: Rear Cross-Traffic Collision Warning operating range

[B]: Rear Cross-Traffic Collision-Avoidance Assist operating range

⚠ CAUTION

The time of warning may vary depending on vehicle speed of the approaching vehicle.

Detecting sensor

Rear corner radar



Refer to the picture above for the detailed location of the detecting sensor.

*** NOTICE**

For more details on the precautions of the rear corner radar, refer to "Blind-Spot Collision-Avoidance Assist (BCA) (if equipped)" on page 7-39.

Rear Cross-Traffic Collision-Avoidance Assist settings

Rear Cross-Traffic Safety

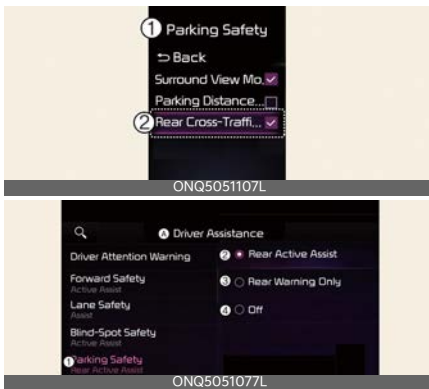

A: Driver assistance

- 1 Parking safety**
- 2 Rear Active Assist**
- 3 Rear Warning Only**
- 4 Off**

With the vehicle on, select **Driver assistance** → **Parking safety** → **Rear Active Assist** from the Settings menu to turn on Rear Cross-Traffic Collision-Avoidance Assist and deselect to turn off the function.

⚠ WARNING

When the vehicle is restarted, Rear Cross-Traffic Collision-Avoidance Assist will automatically turn on. However, if **Off** is selected after the vehicle is restarted, the driver should always be

aware of the surroundings and drive safely.

Warning Timing

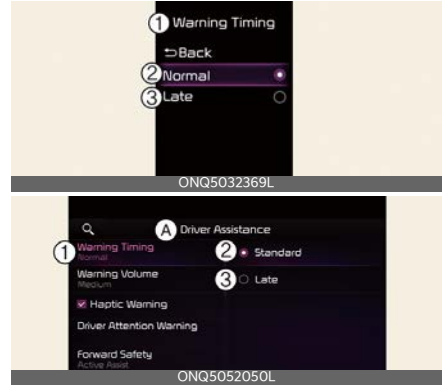

A: Driver assistance

- 1 Warning timing**
- 2 Normal**
- 3 Late**

With the vehicle on, select **Driver assistance** → **Warning timing** from the Settings menu to change the initial warning activation time for Rear Cross-Traffic Collision-Avoidance Assist.

When the vehicle is first delivered, Warning Timing is set to **Normal**. If you change the Warning Timing, the warning time of other Driver Assistance systems may change.

Warning Volume

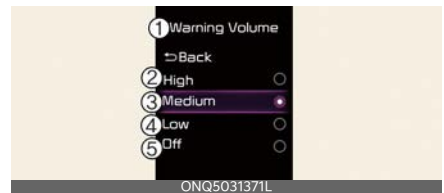



A: Driver assistance

1 Warning volume

2 High

3 Medium

4 Low

5 Off(If steering wheel vibration function is equipped)

With the vehicle on, select **Driver assistance** → **Warning volume** from the Settings menu to change the Warning Volume to **High, Medium, Low** or **Off** for Rear Cross-Traffic Collision-Avoidance Assist.

However, when Warning Volume is turned off, the steering wheel vibration function (If equipped) will turn on.

If you change the Warning Volume, the warning volume of other Driver Assistance systems may change.

⚠ CAUTION

- The setting of the Warning Timing and Warning Volume applies to all functions of the Rear Collision-Avoidance Assist.
- Even though **Normal** is selected for Warning Timing, if the vehicles from the blind spot area approaches at high speed, the initial warning activation time may seem late.
- Select **Late** for Warning Timing when traffic is light and when driving speed is slow.

*** NOTICE**

If the vehicle is restarted, Warning Timing and Warning Volume will maintain the last setting.

Rear Cross-Traffic Collision-Avoidance Assist operation

Warning and control

Rear Cross-Traffic Collision-Avoidance Assist will warn and control the vehicle depending on collision level

- Collision Warning
- Emergency Braking
- Stopping vehicle and ending brake control

Collision warning

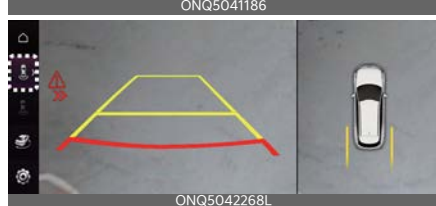

- To warn the driver of an approaching vehicle from the rear left/right side of your vehicle, the warning light on the outside rear view mirror will blink and

a warning will appear on the cluster. At the same time, an audible warning will sound and the steering wheel will vibrate (if equipped). If the Rear View Monitor is operating, a warning will also appear on the infotainment system screen. (if equipped)

- Rear Cross-Traffic Collision-Avoidance Assist will operate when all the following conditions are satisfied:
 - The gear is shifted to R (Reverse) and the vehicle speed is below 8 km/h (5 mph)
 - The approaching vehicle is within approximately 25 m (82 ft.) from the blind spot area of your vehicle
 - The speed of the vehicle approaching from the blind spot area is above 5 km/h (3 mph)

*** NOTICE**

If the operating conditions are satisfied, there will be a warning whenever the vehicle approaches from the left or right side even though your vehicle speed is 0 km/h (0 mph).

Emergency braking

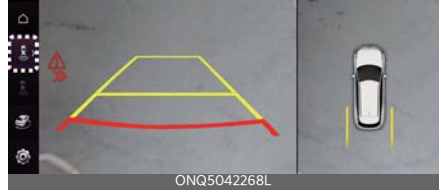
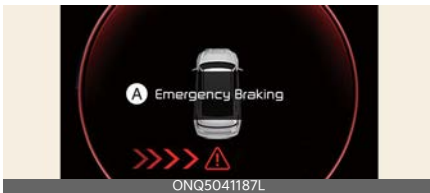

A: Emergency braking

- To warn the driver of an approaching vehicle from the rear left/right side of your vehicle, the warning light on the outside rear view mirror will blink and a warning message will appear on the cluster. At the same time, an audible warning will sound and the steering wheel will vibrate (if equipped). If the Rear View Monitor is operating, a warning will also appear on the infotainment system screen. (if equipped)
- Rear Cross-Traffic Collision-Avoidance Assist will operate when all the following conditions are satisfied:
 - The gear is shifted to R (Reverse) and the vehicle speed is below 8 km/h (5 mph)
 - The approaching vehicle is within approximately 1.5 m (5 ft.) from the blind spot area of your vehicle
 - The speed of the vehicle approaching from the left and right is above 5 km/h (3 mph)
- Emergency braking will be assisted to help prevent collision with approaching vehicles from the blind spot area.

⚠ WARNING

Brake control will end:

- The approaching vehicle is out of the detecting range
- The approaching vehicle passes behind your vehicle
- The approaching vehicle does not drive toward your vehicle

- The approaching vehicle speed slows down
- The driver depresses the brake pedal with sufficient power

Stopping vehicle and ending brake control



A: Drive carefully

- When the vehicle is stopped due to emergency braking, the warning message will appear on the cluster. For your safety, the driver should depress the brake pedal immediately and check the surroundings.
 - Brake control will end after the vehicle is stopped by emergency braking for approximately 2 seconds.
 - During emergency braking, braking control by the function will automatically cancel when the driver excessively depresses the brake pedal.

⚠ WARNING

Take the following precautions when using Rear Cross-Traffic Collision-Avoidance Assist:

- For your safety, set the Settings after parking the vehicle at a safe location.
- If any other function's warning message is displayed or audible warning is generated, Rear Cross-Traffic Safety function's warning message may not be displayed and audible warning may not be generated.
- You may not hear the warning sound of Rear Cross-Traffic Collision-Avoidance Assist if the surrounding is noisy.
- Rear Cross-Traffic Collision-Avoidance Assist may not operate if the driver applies the brake pedal to avoid collision.
- During Rear Cross-Traffic Safety Function Operation, the vehicle may stop suddenly injuring passengers and shifting loose objects. Always have the seat belt on and keep loose objects secured.
- Even if there is a problem with Rear Cross-Traffic Collision-Avoidance Assist, the vehicle's basic braking performance will operate normally.
- Rear Cross-Traffic Collision-Avoidance Assist does not operate in all situations or cannot avoid all collisions.
- When Rear Cross-Traffic Collision-Avoidance Assist is operating, braking control by the function will automatically cancel when the driver excessively depresses the accelerator pedal.
- Rear Cross-Traffic Collision-Avoidance Assist may warn the driver late or may not warn the driver depending on the road and driving conditions.
- The driver should hold the responsibility to control the vehicle. Do not solely depend on Rear Cross-Traffic Collision-Avoidance Assist. Rather, maintain a safe braking distance, and if necessary, depress the brake pedal to reduce driving speed or to stop the vehicle.
- Never deliberately operate Rear Cross-Traffic Collision-Avoidance

Assist on people, animal, objects, etc.
It may cause serious injury or death.

⚠ CAUTION

The brake control may not operate properly depending on the status of ESC (Electronic Stability Control).

There will only be a warning when:

- The ESC (Electronic Stability Control) warning light is on
- ESC (Electronic Stability Control) is engaged in a different function

* NOTICE

If braking is assisted by Rear Cross-Traffic Collision-Avoidance Assist, the driver must immediately depress the brake pedal and check vehicle surroundings.

- Brake control will end when the driver depresses the brake pedal with sufficient power.
- After shifting the gear to R (Reverse), braking control will operate once for left and right vehicle approach.

* NOTICE

The images or colours may be displayed differently depending on the specifications of the instrument cluster or theme.

Rear Cross-Traffic Collision-Avoidance Assist malfunction and limitations

Rear Cross-Traffic Collision-Avoidance Assist malfunction

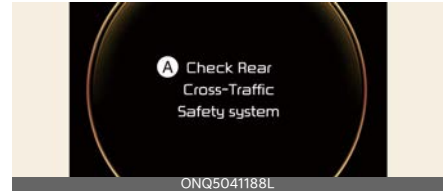

A: Check Rear Cross-Traffic Safety system

When Rear Cross-Traffic Collision-Avoidance Assist is not working properly, the warning message will appear and the master warning light (⚠) will appear on the cluster. Have the function be inspected by a professional workshop. Kia recommends visiting an authorised Kia dealer/service partner.

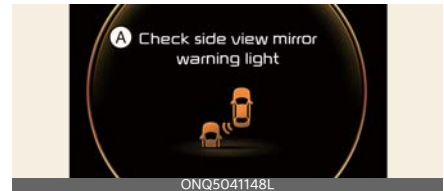

A: Check side view mirror warning light

When the outside rear view mirror warning light is not working properly, the warning message will appear and the master warning light (⚠) will appear on the cluster. Have the function be inspected by a professional workshop. Kia recommends visiting an authorised Kia dealer/service partner.

Rear Cross-Traffic Collision-Avoidance Assist disabled

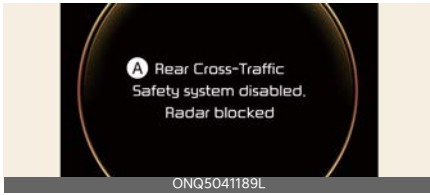

A: Rear Cross-Traffic Safety system disabled. Radar blocked

When the rear bumper around the rear corner radar or rear sensor is covered with foreign material, such as snow or rain, or installing a trailer or carrier, it can reduce the detecting performance and temporarily limit or disable Rear Cross-Traffic Collision-Avoidance Assist.

If this occurs, the warning message will appear on the cluster. But it is not a Rear Cross-Traffic Collision-Avoidance Assist malfunction.

The function will operate normally when such foreign material or trailer, etc. is removed. Always keep it clean.

If the function does not operate normally after it is removed, have the function be inspected by a professional workshop. Kia recommends visiting an authorised Kia dealer/service partner.

⚠ WARNING

- Even though the warning message or warning light does not appear on the cluster, Rear Cross-Traffic Collision-Avoidance Assist may not operate properly.
- Rear Cross-Traffic Collision-Avoidance Assist may not operate properly in an area or contaminated (for example: open terrain), where any sub-

stance are not detected after turning ON the vehicle.

⚠ CAUTION

Turn off Rear Cross-Traffic Collision-Avoidance Assist to install a trailer, carrier, etc., or remove the trailer, carrier, etc. to use Rear Cross-Traffic Collision-Avoidance Assist.

Limitations of Rear Cross-Traffic Collision-Avoidance Assist

Rear Cross-Traffic Collision-Avoidance Assist may not operate normally, or the function may operate unexpectedly under the following circumstances:

- Departing from where trees or grass are overgrown
- Departing from where roads are wet
- Speed of the approaching vehicle is fast or slow

Braking control may not work, driver's attention is required in the following circumstances:

- The vehicle severely vibrates whilst driving over a bumpy road, uneven road or concrete patch
- Driving on a slippery surface due to snow, water puddle, ice, etc.
- The tyre pressure is low or a tyre is damaged
- The brake is reworked
- Remote Smart Parking Assist is operating (if equipped)

* NOTICE

For more details on the limitations of the rear corner radar, refer to "Blind-Spot Collision-Avoidance Assist (BCA) (if equipped)" on page 7-39.

⚠ WARNING

- Driving near a vehicle or structure



[A]: Structure

Rear Cross-Traffic Collision-Avoidance Assist may be limited when driving near a vehicle or structure, and may not detect the vehicle approaching from the blind spot area. If this occurs, the function may not warn the driver or control the brakes when necessary.

Always check your surroundings whilst Reversing.

- When the vehicle is in a complex parking environment



Rear Cross-Traffic Collision-Avoidance Assist may detect vehicles which are parking or pulling out near your vehicle (for example: a vehicle leaving beside your vehicle, a vehicle parking or pulling out in the rear area, a vehicle approaching your vehicle making a turn, etc.). If this occurs, the function may unnecessarily warn the driver and control the brake.

Always check your surroundings whilst Reversing.

- When the vehicle is parked diagonally



[A]: Vehicle

Rear Cross-Traffic Collision-Avoidance Assist may be limited when Reversing diagonally, and may not detect the vehicle approaching from the blind spot area. If this occurs, the function may not warn the driver or control the brakes when necessary. Always check your surroundings whilst Reversing.

- When the vehicle is on or near a slope



Rear Cross-Traffic Collision-Avoidance Assist may be limited when the vehicle is on an uphill or downhill slope, or near it, and may not detect the vehicle approaching from the blind spot area. If this occurs, the function may not warn the driver or control the brakes when necessary.

Always check your surroundings whilst Reversing.

- Pulling into the parking space where there is a structure



[A]: Structure, [B]: Wall

Rear Cross-Traffic Collision-Avoidance Assist may detect vehicles passing by in front of you when parking backwards into a parking space with a wall or structure in the rear or side area. If this occurs, the function may unnecessarily warn the driver and control the brake.

Always check your surroundings whilst Reversing.

- When the vehicle is parked rearward

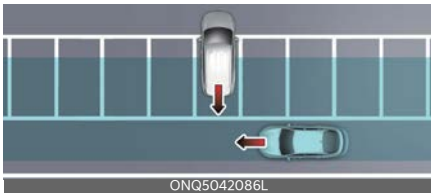

Rear Cross-Traffic Collision-Avoidance Assist may detect vehicles passing by behind you when parking backwards into a parking space. If this occurs, the function may unnecessarily warn the driver and control the brake.

Always check your surroundings whilst Reversing.

Assist. The function could destabilize the vehicle.

- Rear Cross-Traffic Collision-Avoidance Assist may not operate suddenly if interfered by strong electromagnetic waves.
- Rear Cross-Traffic Collision-Avoidance Assist may not operate for 15 seconds after the vehicle is started, or the rear corner radars are initialized.

⚠ WARNING

- When you are towing a trailer or another vehicle, do not use Rear Cross-Traffic Collision-Avoidance

Reverse Parking Distance Warning (PDW) (if equipped)

Reverse Parking Distance Warning will help warn the driver if a person, an animal or an object is detected within a certain distance when the vehicle is moving in reverse.

Detecting sensor

Rear ultrasonic sensors



Refer to the picture above for the detailed location of the detecting sensors.

Reverse Parking Distance Warning settings

Warning methods

Type A

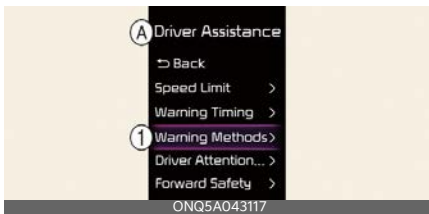

Type B

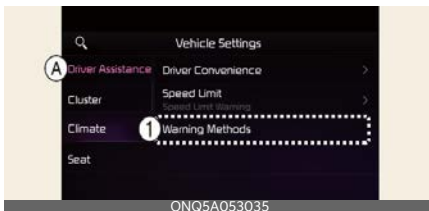

A: Driver Assistance

1 Warning Methods

The Warning Methods can be set with the vehicle on. Select **User Settings** → **Driver Assistance** → **Warning Methods** from the settings menu in the instrument cluster or **Settings** → **Vehicle** → **Driver Assistance** → **Warning Methods** from the settings menu in the infotainment system to change the following settings:

- **Warning Volume:** Adjusts the volume of the warning sound.

* INFORMATION

- If you change the Warning Methods, it can be applied to each function of the driver assistance system. Please check and change it in each function.
- If the vehicle is restarted, Warning Methods will maintain the last setting.
- The setting menu may not exist based on vehicle specification.

Parking Distance Warning Auto On

You can set the Parking Distance Warning to be ON at low speeds. To use Parking Distance Warning Auto On function, select **Settings** → **Vehicle** → 'Driver Assistance' → **Parking safety** → **Parking Distance Warning Auto On** from the infotainment system with the vehicle ON.

* NOTICE

If Parking Distance Warning Auto On is selected, the Parking Safety (P) button indicator light will turn on.

Reverse Parking Distance Warning operation

Parking Safety button



Press the Parking Safety (P) button to turn on or off Reverse Parking Distance Warning.



- When Reverse Parking Distance Warning is off (button indicator light off), if you shift the gear to R (Reverse), Reverse Parking Distance Warning will automatically turn on.
- If you shift the gear to R (Reverse), Reverse Parking Distance Warning will not turn off even if you press the Parking Safety (P) button for your safety.

Reverse Parking Distance Warning

Reverse Parking Distance Warning will operate under the following conditions.

- Shift the gear to R (Reverse).
- The vehicle's speed is below 10 km/h (6 mph).

Function indications and warnings

| Distance from object | Warning indicator when driving backward | Warning sound |
|--------------------------|---|-----------------------------|
| 60-120 cm (24-48 inches) |  | Buzzer beeps intermittently |
| 30-60 cm (12-24 inches) |  | Beeps more frequently |
| within 30 cm (12 inches) |  | Beeps continuously |

- The corresponding indicator will appear on the cluster or infotainment system whenever each ultrasonic sensor detects a person, animal or object in its sensing range. Also an audible warning will sound.
- When more than two objects are detected at the same time, the closest one will be warned with an audible warning.
- Distance from object may be detected differently when obstacles are not located in front of the sensor.
- The shape of the indicator in the illustration may differ from the actual vehicle.

Reverse Parking Distance Warning malfunction and precautions

Reverse Parking Distance Warning malfunction

After starting the vehicle, a beep will sound once when the gear is shifted to R (Reverse) to indicate Reverse Parking Distance Warning is operating normally.

However, if one or more of the following occurs, first check whether the ultrasonic sensor is damaged or blocked with foreign material. If it still does not work properly, Kia recommends visiting an authorised Kia dealer/service partner.

- The audible warning does not sound.
- The buzzer sounds intermittently.
- The warning message appears on the cluster.

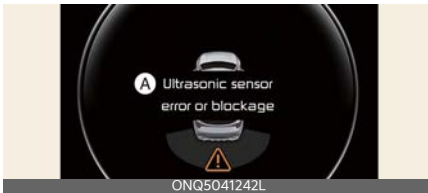

A: Ultrasonic sensor error or blockage

Limitations of Reverse Parking Distance Warning

- Reverse Parking Distance Warning may not operate normally when:
 - Moisture is frozen to the sensor (Reverse Parking Distance Warning will operate normally when it is melted.)
 - Sensor is covered with foreign material, such as snow or water (Reverse Parking Distance Warning will operate normally when such foreign material are removed.)
 - The weather is extremely hot or cold

- The sensor or sensor assembly is disassembled
- The surface of the sensor is pressed hard or an impact is applied with a hard object
- The surface of the sensor is scratched with a sharp object
- The sensors or its surrounding area is directly sprayed with high pressure washer
- Reverse Parking Distance Warning may malfunction when:
 - Heavy rain or water spray is present
 - Water flows on the surface of the sensor
 - Affected by another vehicle's sensors
 - The sensor is covered with snow
 - Driving on uneven road, gravel roads or bushes
 - Objects that generates ultrasonic waves are near the sensor
 - Installing the license plate differently from the original location
 - The vehicle bumper height or ultrasonic sensor installation has been modified
 - Attaching equipments or accessories around the ultrasonic sensors
- The following objects may not be detected:
 - Sharp or slim objects, such as ropes, chains or small poles.
 - Objects, which tend to absorb sensor frequency, such as clothes, spongy material or snow.
 - Objects smaller than 100 cm (40 inches) in length and narrower than 14 cm (6 inches) in diameter.

- Pedestrians, animals or objects that are very close to the ultrasonic sensors

⚠ WARNING

- Reverse Parking Distance Warning is a supplemental function. The operation of Reverse Parking Distance Warning can be affected by several factors (including environmental conditions). It is the responsibility of the driver to always check the rear view before and whilst parking.
- Your vehicle warranty does not cover any accidents or damage to the vehicle due to the malfunction of Reverse Parking Distance Warning.
- Pay close attention when driving near objects, pedestrians, and especially children. Some objects may not be detected by the ultrasonic sensors, due to the objects distance, size or material, all of which can limit the effectiveness of the sensor.
- Parking Distance Warning indicator may not occur sequentially depending on vehicle speed or obstacle shape.
- If Reverse Parking Distance Warning needs repair, Kia recommends visiting an authorised Kia dealer/service partner.

Forward/Reverse Parking Distance Warning (PDW) (if equipped)

Forward/Reverse Parking Distance Warning will help warn the driver if a person, an animal or an object is detected within a certain distance from the ultrasonic sensors when the vehicle is moving forward or in reverse.

Detecting sensor

Front ultrasonic sensors



Rear ultrasonic sensors



Refer to the picture above for the detailed location of the detecting sensors.

Forward/Reverse Parking Distance Warning settings

Warning methods

Type A

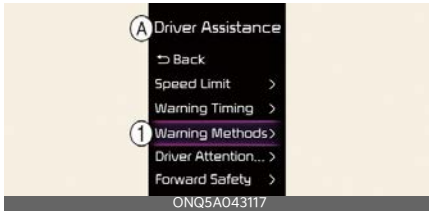

Type B

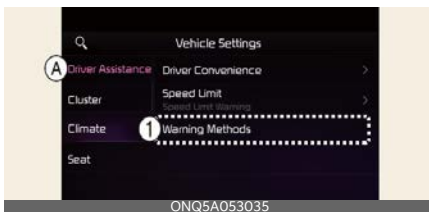

A: Driver Assistance

1 Warning Methods

The Warning Methods can be set with the vehicle on. Select **User Settings** → **Driver Assistance** → **Warning Methods** from the settings menu in the instrument cluster or **Settings** → **Vehicle** → **Driver Assistance** → **Warning Methods** from the settings menu in the infotainment system to change the following settings:

- **Warning Volume:** Adjusts the volume of the warning sound.

* INFORMATION

- If you change the Warning Methods, it can be applied to each function of the driver assistance system. Please check and change it in each function.
- If the vehicle is restarted, Warning Methods will maintain the last setting.

- The setting menu may not exist based on vehicle specification.

Parking Distance Warning Auto On

You can set the parking distance warning to be ON at low speeds. To use Parking Distance Warning Auto On function, select **Driver assistance** → **Parking safety** → **Parking Distance Warning Auto On** from the Settings menu.

* NOTICE

If Parking Distance Warning Auto On is selected, the Parking Safety (P▲) button indicator light will turn on.

Forward/Reverse Parking Distance Warning operation

Parking Safety button



Press the Parking Safety (P▲) button to turn on or off Forward/Reverse Parking Distance Warning.

- When Forward/Reverse Parking Distance Warning is off (button indicator light off), if you shift the gear to R (Reverse), Forward/Reverse Parking Distance Warning will automatically turn on.
- If you shift the gear to R (Reverse), Forward/Reverse Parking Distance Warning will not turn off even if you press the Parking Safety (P▲) button for your safety.

Forward Parking Distance Warning



Forward Parking Distance Warning will operate when one of the condition is satisfied.

- The gear is shifted from R (Reverse) to D (Drive)
- The gear is in D (Drive) and the Parking Safety (P) button indicator light is on
- **Parking Distance Warning Auto On** is selected from the Settings menu and the gear is in D (Drive)
- The function warns the driver when **Settings** → **Vehicle** → **Driver assistance** → **Parking safety** → **Parking Distance Warning Auto On** is selected from the infotainment system, and the gear is in D (Drive)
- Vehicle speed is below 10 km/h (6 mph)

* NOTICE

- Forward Parking Distance Warning does not operate when the vehicle's forward speed is above 10 km/h (6 mph) even when the function is on (Parking Safety button indicator is on). Forward Parking Distance Warning will operate again when the vehicle's forward speed decreases below 10 km/h (6 mph).
- When the vehicle's forward speed is above 30 km/h (18 mph), the Forward Parking Distance Warning will turn off (Parking Safety button indicator off). Although you drive below 10 km/h (6 mph) again, Forward Parking Distance Warning will not automatically turn on (If **Driver assistance** → **Parking safety** → **Parking Distance Warning Auto On** not selected).

Function indications and warnings

| Distance from object | Warning indicator when driving forward | Warning sound |
|--------------------------|---|-----------------------------|
| 60-100 cm (24-40 inches) |  | Buzzer beeps intermittently |
| 30-60 cm (12-24 inches) |  | Beeps more frequently |
| within 30 cm (12 inches) |  | Beeps continuously |

- The corresponding indicator will appear on the cluster or infotainment system screen whenever each ultrasonic sensor detects a person, animal or object in its sensing range. Also an audible warning will sound.
- When more than two objects are detected at the same time, the closest one will be warned with an audible warning.
- Distance from object may be detected differently when obstacles are not located in front of the sensor.
- The shape of the indicator in the illustration may differ from the actual vehicle.

Reverse Parking Distance Warning



Reverse Parking Distance Warning will operate when one of the condition is satisfied.

- The gear is shifted to R (Reverse).
- The vehicle's rearward speed is below 10 km/h (6 mph).

*** NOTICE**

When the vehicle's rearward speed is below 10 km/h (6 mph), both the front and rear ultrasonic sensors will detect objects. However, the front ultrasonic sensors can detect a person, animal or object when it is within 60 cm (24 inches) from the sensors.

Function indications and warnings

| Distance from object | Warning indicator when driving backward | Warning sound |
|--------------------------|---|-----------------------------|
| 60-120 cm (24-48 inches) |  | Buzzer beeps intermittently |
| 30-60 cm (12-24 inches) |  | Beeps more frequently |
| within 30 cm (12 inches) |  | Beeps continuously |

- The corresponding indicator will appear on the cluster or infotainment system screen whenever each ultrasonic sensor detects a person, animal or object in its sensing range. Also an audible warning will sound.
- When more than two objects are detected at the same time, the closest one will be warned with an audible warning.
- Distance from object may be detected differently when obstacles are not located in front of the sensor.
- The shape of the indicator in the illustration may differ from the actual vehicle.

Forward/Reverse Parking Distance Warning malfunction and precautions

Forward/Reverse Parking Distance Warning malfunction

After starting the vehicle, a beep will sound once when the gear is shifted to R (Reverse) to indicate Forward/Reverse Parking Distance Warning is operating normally.

However, if one or more of the following occurs, first check whether the ultrasonic sensor is damaged or blocked with foreign material. If it still does not work properly, Kia recommends visiting an authorised Kia dealer/service partner.

- The audible warning does not sound.
- The buzzer sounds intermittently.
- The warning message appears on the cluster.



A: Ultrasonic sensor error or blockage

Limitations of Forward/Reverse Parking Distance Warning

- Forward/Reverse Parking Distance Warning may not operate normally when:
 - Moisture is frozen to the sensor (Forward/Reverse Parking Distance Warning will operate normally when it is melted.)
 - Sensor is covered with foreign material, such as snow or water (Forward/Reverse Parking Distance Warning will operate nor-

- mally when such foreign material are removed.)
- The weather is extremely hot or cold
- The sensor or sensor assembly is disassembled
- The surface of the sensor is pressed hard or an impact is applied with a hard object
- The surface of the sensor is scratched with a sharp object
- The sensors or its surrounding area is directly sprayed with high pressure washer
- Forward/Reverse Parking Distance Warning may malfunction when:
 - Heavy rain or water spray is present
 - Water flows on the surface of the sensor
 - Affected by another vehicle's sensors
 - The sensor is covered with snow
 - Driving on uneven road, gravel roads or bushes
 - Objects that generates ultrasonic waves are near the sensor
 - Installing the license plate differently from the original location
 - The vehicle bumper height or ultrasonic sensor installation has been modified
 - Attaching equipments or accessories around the ultrasonic sensors
- The following objects may not be detected:
 - Sharp or slim objects, such as ropes, chains or small poles.
 - Objects, which tend to absorb sensor frequency, such as clothes, spongy material or snow.

- Objects smaller than 100 cm (40 inches) in length and narrower than 14 cm (6 inches) in diameter.
- Pedestrians, animals or objects that are very close to the ultrasonic sensors

⚠ WARNING

- Forward/Reverse Parking Distance Warning is a supplemental function. The operation of Forward/Reverse Parking Distance Warning can be affected by several factors (including environmental conditions). It is the responsibility of the driver to always check the front and rear views before and whilst parking.
 - Your vehicle warranty does not cover any accidents or damage to the vehicle due to the malfunction of Forward/Reverse Parking Distance Warning.
 - Pay close attention when driving near objects, pedestrians, and especially children. Some objects may not be detected by the ultrasonic sensors, due to the objects distance, size or material, all of which can limit the effectiveness of the sensor.
 - Parking Distance Warning indicator may not occur sequentially depending on vehicle speed or obstacle shape.
 - If Forward/Reverse Parking Distance Warning needs repair, Kia recommends visiting an authorised Kia dealer/service partner.
-

Reverse Parking Collision-Avoidance Assist (PCA) (if equipped)

Reverse Parking Collision-Avoidance Assist will warn the driver or assist with braking to help reduce the possibility of collision with a pedestrian or an object when Reversing.

Detecting sensor

Rear view camera



Rear ultrasonic sensors



Refer to the picture above for the detailed location of the detecting sensors.

Reverse Parking Collision-Avoidance Assist settings

Parking Safety

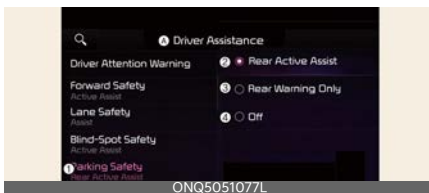

- A: Driver assistance
1 Parking safety

2 Rear Collision-Avoidance Assist

3 Rear Collision Warning

4 Off

With the vehicle on, select or deselect **Driver assistance** → **Parking safety** from the Settings menu to set whether or not to use each function.

- **Rear Collision-Avoidance Assist:** Reverse Parking Collision-Avoidance Assist will warn the driver and assist with braking when a collision with a pedestrian or an object is imminent.
- **Rear Collision Warning:** Reverse Parking Collision-Avoidance Assist will warn the driver when a collision with a pedestrian or an object is imminent. Braking will not be assisted.
- **Off:** Reverse Parking Collision-Avoidance Assist will turn off.

Turning On/Off



Press and hold the Parking Safety (P+L) button for more than 2 seconds to turn Rear Active Assist or Rear Warning Only on or off.

Warning Timing



- A: Driver assistance
1 Warning timing

2 Normal

3 Late

With the vehicle on, select **Driver assistance** → **Warning timing** from the Settings menu to change the initial warning activation time for Reverse Parking Collision-Avoidance Assist.

- **Normal:** Use in a normal driving environment. If the function operates too sensitively, set to the warning timing to **Late**.
- **Late:** The warning timing will be slow.

*** NOTICE**

If you change the Warning Timing, the Warning Timing of other Driver Assistance systems may change.

Warning methods

Type A

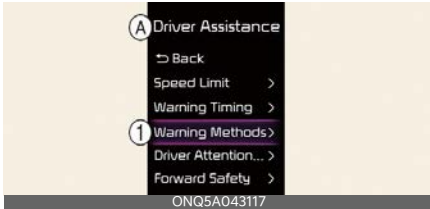

Type B

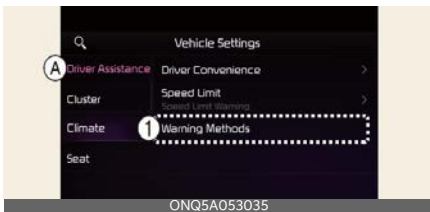

A: Driver Assistance

1 Warning Methods

The Warning Methods can be set with the vehicle on. Select **Driver Assistance** → **Warning Methods** from the settings menu in the instrument cluster or **Set-**

tings → **Vehicle** → **Driver Assistance** → **Warning Methods** from the settings menu in the infotainment system to change the following settings:

- **Warning Volume:** Adjusts the volume of the warning sound.
- **Haptic Warning:** Activate the steering wheel vibration warning. (if equipped)

*** INFORMATION**

- If you change the Warning Methods, it can be applied to each function of the driver assistance system. Please check and change it in each function.
- If the vehicle is restarted, Warning Methods will maintain the last setting.
- The setting menu may not exist based on vehicle specification.

Reverse Parking Collision-Avoidance Assist operation

Operating conditions

After selecting **Rear Collision-Avoidance Assist** or **Rear Collision Warning** from the Settings menu, Reverse Parking Collision-Avoidance Assist will turn on when the following conditions are satisfied:

- The tailgate is closed
- The gear is shifted to R (Reverse)
- Vehicle speed is below 10 km/h (6 mph)
- Reverse Parking Collision-Avoidance Assist components such as the rear view camera and the rear ultrasonic sensors are in normal conditions

When Reverse Parking Collision-Avoidance Assist activates, a line appears behind the vehicle image in the instrument cluster.



ONQ5041191

* NOTICE

Reverse Parking Collision-Avoidance Assist operates only once after the gear is shifted to R (Reverse). To reactivate Reverse Parking Collision-Avoidance Assist, shift the gear from another gear to R (Reverse).

Rear Active Assist

If Reverse Parking Collision-Avoidance Assist detects a risk of collision with a pedestrian or an object, Reverse Parking Collision-Avoidance Assist will warn the driver with an audible warning, steering wheel vibration (if equipped), and warning message on the cluster. When Rear View Monitor is operating, a warning will appear on the infotainment system screen. The warning will turn off when the driver shifts the gear to P (Park), N (Neutral), or D (Drive).

If Reverse Parking Collision-Avoidance Assist detects an imminent collision with a pedestrian or an object behind the vehicle, Reverse Parking Collision-Avoidance Assist will assist you with braking. The driver needs to pay attention as the brake assist will end within 5 minutes. Brake control will also end when:

- The gear is shifted to P (Park) or D (Drive).
- The driver depresses the brake pedal with sufficient power.

* NOTICE

If braking assist has lasted for approximately 5 minutes, the Electronic Parking Brake **EPB** will be engaged simultaneously.

Rear Collision Warning

If Reverse Parking Collision-Avoidance Assist detects a risk of collision with a pedestrian or an object, Reverse Parking Collision-Avoidance Assist will warn the driver with an audible warning, steering wheel vibration (if equipped), and warning message on the cluster. When Rear View Monitor is operating, a warning will appear on the infotainment system screen. Braking will not be assisted. The warning will turn off when the gear is shifted to P (Park), N (Neutral) or D (Drive).

Reverse Parking Collision-Avoidance Assist malfunction and limitations

Reverse Parking Collision-Avoidance Assist malfunction

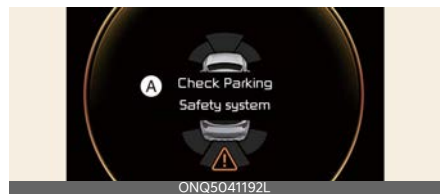

ONQ5041192L

A: Check Parking Safety system

When Reverse Parking Collision-Avoidance Assist or other related functions are not working properly, the warning message will appear on the cluster, and Reverse Parking Collision-Avoidance Assist will turn off automatically.

Kia recommends visiting an authorised Kia dealer/service partner.

Reverse Parking Collision-Avoidance Assist disabled

Wide-rear view camera



The wide-rear view camera is used as a detecting sensor to detect pedestrians. If the camera lens is covered with foreign material, such as snow or rain, it may adversely affect camera performance and Reverse Parking Collision-Avoidance Assist may not operate normally. Always keep the camera lens clean.

Rear ultrasonic sensors



The rear ultrasonic sensors are located inside the rear bumper to detect objects in the rear area. If the sensors are covered with foreign material, such as snow or rain, it may adversely affect sensor performance and Reverse Parking Collision-Avoidance Assist may not operate normally. Always keep the rear bumper clean.

The warning message will appear on the cluster if the following situations occur:

Wide-rear view camera

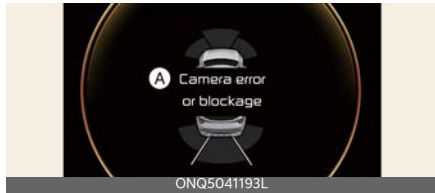

A: Camera error or blockage

Rear ultrasonic sensors



A: Ultrasonic sensor error or blockage

- The rear view camera or rear ultrasonic sensor(s) is covered with foreign material, such as snow or rain, etc.
- There is inclement weather, such as heavy snow, heavy rain, etc.

If this occurs, Reverse Parking Collision-Avoidance Assist may turn off or may not operate properly. Check whether the rear view camera and rear ultrasonic sensors are clean.

Limitations of Reverse Parking Collision-Avoidance Assist

Reverse Parking Collision-Avoidance Assist may not assist braking or warn the driver even if there are pedestrians or objects under the following circumstances:

- Any non-factory equipment or accessory is installed
- Your vehicle is unstable due to an accident or other causes
- Bumper height or rear ultrasonic sensor installation has been modified

- Rear view camera or rear ultrasonic sensor(s) is damaged
- Rear view camera or the rear ultrasonic sensor(s) is stained with foreign material, such as snow, dirt, etc.
- Rear view camera is obscured by a light source or by inclement weather, such as heavy rain, fog, snow, etc.
- The surrounding is very bright or very dark
- Outside temperature is very high or very low
- The wind is either strong (above 20 km/h (12 mph)) or blowing perpendicular to the rear bumper
- Objects generating excessive noise, such as vehicle horns, loud motorcycle engines or truck air brakes, are near your vehicle
- An ultrasonic sensor with similar frequency is near your vehicle
- The pedestrians are difficult to recognise under following conditions:
 - There is ground height difference between the vehicle and the pedestrian
 - The image of the pedestrian in the rear view camera is indistinguishable from the background
 - The pedestrian is near the rear edge of the vehicle
 - The pedestrian is not standing upright
 - The pedestrian is either very short or very tall for Reverse Parking Collision-Avoidance Assist to detect
 - The pedestrian or cyclist is wearing clothing that easily blends into the background, making it difficult to detect

- The pedestrian is wearing clothing that does not reflect ultrasonic waves well
- Size, thickness, height, or shape of the object does not reflect ultrasonic waves well (e.g., pole, bush, kerbs, carts, edge of a wall, etc.)
- The pedestrian or the object is moving
- The pedestrian or the object is very close to the rear of the vehicle
- A wall is behind the pedestrian or the object
- The object is not located at the rear centre of your vehicle
- The object is not parallel to the rear bumper
- The road is slippery or inclined
- The driver backs up the vehicle immediately after shifting to R (Reverse)
- The driver accelerates or circles the vehicle

Reverse Parking Collision-Avoidance Assist may unnecessarily warn the driver or assist with braking even if there are no pedestrians or objects under the following circumstances:

- Any non-factory equipment or accessory is installed
- Your vehicle is unstable due to an accident or other causes
- Bumper height or rear ultrasonic sensor installation has been modified
- Your vehicle height is low or high due to heavy loads, abnormal tyre pressure, etc.
- Rear view camera or the rear ultrasonic sensor(s) is stained with foreign material, such as snow, dirt, etc.
- The pattern on the road is mistaken for a pedestrian

- There is shadow or light reflecting on the ground
- Pedestrians or objects are around the path of the vehicle
- Objects generating excessive noise, such as vehicle horns, loud motorcycle engines or truck air brakes, are near your vehicle
- Your vehicle is backing towards a narrow passage or parking space
- Your vehicle is backing towards an uneven road surface, such as an unpaved road, gravel, bump, gradient, etc.
- A trailer or carrier is installed on the rear of your vehicle
- An ultrasonic sensor with similar frequency is near your vehicle

⚠ WARNING

- Always pay extreme caution whilst driving. The driver is responsible for controlling the brake for safe driving.
- Always pay attention to road and traffic conditions whilst driving, whether or not there is a warning.
- Always look around your vehicle to make sure there are no pedestrians or objects before moving the vehicle.
- The performance of Reverse Parking Collision-Avoidance Assist may vary under certain conditions. If vehicle speed is above 4 km/h (2 mph), Reverse Parking Collision-Avoidance Assist will provide collision avoidance assist only when pedestrians are detected. Always look around and pay attention when Reversing your vehicle.
- Some objects may not be detected by the rear ultrasonic sensors due to the objects distance, size or material, all of

- which can limit the effectiveness of the sensor.
- Reverse Parking Collision-Avoidance Assist may not operate properly or may operate unnecessarily depending on the road conditions and the surroundings.
- Do not solely rely on Reverse Parking Collision-Avoidance Assist. Doing so may lead to vehicle damage or injuries.
- Always keep the rear view camera and rear ultrasonic sensors clean.
- Do not use any cleanser containing acid or alkaline detergents when cleaning the rear view camera lens. Use only a mild soap or neutral detergent, and rinse thoroughly with water.
- Do not spray the rear view camera or the rear ultrasonic sensors or their surrounding area directly with a high pressure washer. It may cause the rear view camera or the rear ultrasonic sensors to malfunction.
- Do not apply objects, such as a bumper sticker or a bumper guard, near the rear view camera or rear ultrasonic sensors or apply paint to the bumper. Doing so may adversely affect the performance of Reverse Parking Collision-Avoidance Assist.
- Never disassemble or apply impact on the rear view camera or the rear ultrasonic sensors components.
- Do not apply unnecessary force on the rear view camera or the rear ultrasonic sensors. Reverse Parking Collision-Avoidance Assist may not operate properly if the rear view camera or the rear ultrasonic sensor(s) is forcibly moved out of proper alignment. Kia recommends visiting an authorised Kia dealer/service partner.

- Noise may be heard when sudden braking occurs to avoid a collision.
- If any other warning sound such as the seat belt warning chime is already generated, Reverse Parking Collision-Avoidance Assist warning may not sound.
- Reverse Parking Collision-Avoidance Assist may not work properly if the bumper has been damaged, replaced or repaired.
- Reverse Parking Collision-Avoidance Assist may not operate normally if interfered by strong electromagnetic waves.
- Playing the vehicle audio system at high volume may prevent passengers from hearing Reverse Parking Collision-Avoidance Assist warning sounds.
- The brake control may not operate properly depending on the status of ESC (Electronic Stability Control).
There will only be a warning when:
 - The ESC (Electronic Stability Control) warning light is on
 - ESC (Electronic Stability Control) is engaged in a different function

*** NOTICE**

Reverse Parking Collision-Avoidance Assist can detect a pedestrian or an object when:

- A pedestrian is standing behind the vehicle
- A large obstacle, such as a vehicle, is parked in the rear centre of your vehicle

Remote Smart Parking Assist (RSPA) (if equipped)

Remote Smart Parking Assist uses vehicle sensors to help the driver park and exit parking spaces remotely from outside the vehicle by automatically searching for parking spaces, and controlling the steering wheel, vehicle speed and gearshifts.

| Function | Description |
|------------------|--|
| Remote Operation | Remotely moving forward or backward  |

- Remote Smart Parking and Remote Operation function may be operated from outside the vehicle using the smart key.
- Smart Parking and Remote Smart Parking function may be operated from inside the vehicle.
- Smart Parking and Remote Smart Parking function helps the driver with perpendicular reverse parking and parallel reverse parking.
- Smart Exit function helps the driver with parallel forward exit.
- When Remote Smart Parking Assist operates, Parking Distance Warning and Surround View Monitor will also operate. For more details, refer to "Forward/Reverse Parking Distance Warning (PDW) (if equipped)" on page 7-112 and "Surround View Monitor (SVM) (if equipped)" on page 7-89.

Detecting sensor

Front ultrasonic sensors



Front side ultrasonic sensors



Rear side ultrasonic sensors



Rear ultrasonic sensors



Refer to the picture above for the detailed location of the detecting sensors.

⚠ WARNING

- Never disassemble the detecting sensor or sensor assembly, or apply any impact on it.
- If the detecting sensor have been replaced or repaired, we recommend

that you have your vehicle inspected by an authorised Kia dealer/service partner.

- Remote Smart Parking Assist may malfunction if the vehicle bumper height or ultrasonic sensor installation has been modified or damaged. Any non-factory installed equipment or accessories may also interfere with the sensor performance.
- When the ultrasonic sensor is frozen or stained with snow, dirt, or water, the sensor may not operate until the stains are removed using a soft cloth.
- Do not push, scratch or strike the ultrasonic sensor. Sensor damage could occur.
- Do not spray the ultrasonic sensors or its surrounding area directly with a high pressure washer.

Remote Smart Parking Assist settings

Warning methods

Type A

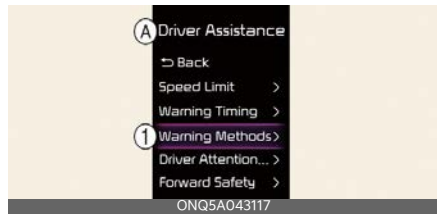

Type B

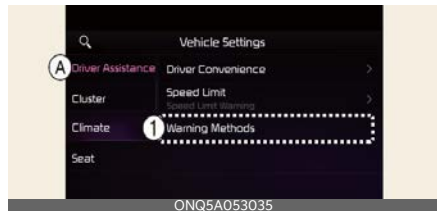

A: Driver Assistance

1 Warning Methods

The Warning Methods can be set with the vehicle on. Select **User Settings** → **Driver Assistance** → **Warning Methods** from the settings menu in the instrument cluster or **Settings** → **Vehicle** → **Driver Assistance** → **Warning Methods** from the settings menu in the infotainment system to change the following settings:

- **Warning Volume:** Adjusts the volume of the warning sound.

* INFORMATION

- If you change the Warning Methods, it can be applied to each function of the driver assistance system. Please check and change it in each function.
- If the vehicle is restarted, Warning Methods will maintain the last setting.
- The setting menu may not exist based on vehicle specification.

Remote Smart Parking Assist operation

Remote Smart Parking button



| Location | Name | Symbol | Description |
|----------------|-----------------------|--------|--|
| Inside vehicle | Parking/View button | | Press and hold the Parking/View button to turn on Remote Smart Parking Assist. Also, Forward/Reverse Parking Distance warning will automatically turn on. |
| | Parking Safety button | | Press the Parking Safety button whilst Remote Smart Parking Assist is operating to end function operation. |
| Smart key | Remote Start button | | <ul style="list-style-type: none"> • Press the Remote Start button after the door is locked with the vehicle off to start the vehicle remotely. • Press the Remote Start button whilst Remote Operation function is operating to end function operation. |
| | Forward button | | When using the Remote Operation function, the vehicle moves in the direction of the button whilst the button is pressed. |
| | Backward button | | |

Remote Operation

Operating order

Remote Operation operates in the following order:

1. Getting ready to remotely move forward and backward
2. Remotely moving forward and backward

1. Getting ready to remotely move forward and backward

There are two ways to operate Remote Operation function.

Method (1): Using the function with vehicle off



1. Within a certain range from the vehicle press the door lock (🔒) button on the smart key and lock all doors.
2. Press and hold the Remote Start button (🔌_{HOLD}) within 4 seconds until the vehicle starts.

* For more details on remotely starting the vehicle, refer to "Locking/unlocking with the smart key" on page 4-12 and "Starting the vehicle remotely (if equipped)" on page 4-9.

Method (2): Using the function with vehicle on

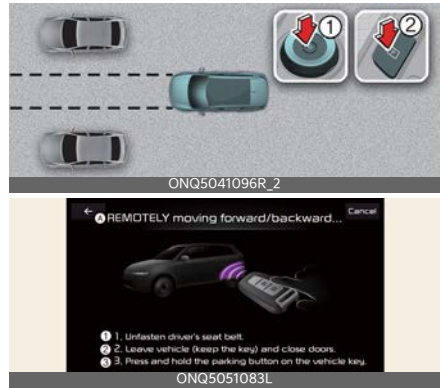

A: REMOTELY moving forward/backward...

1. Unfasten driver's seat belt.
2. Leave car (keep the key) and close doors.
3. Press and hold PARKING button on car key.
 1. Park the vehicle in front of the space where you want to use Remote Operation function, and shift the gear to P (Park).
 2. Press and hold the Parking/View (🅅) button to turn on Smart Parking Assist. A message **Under REMOTE control** will appear on the infotainment system screen.
 3. Get out of the vehicle with the smart key and close all doors.

* NOTICE

Agree must be selected on the infotainment system screen and the infotainment system has to operate properly to use Remote Operation function.

2. Remote Operation



1. Press and hold one of the Forward (⏪) or Backward (⏩) button on the smart key.
 - Remote Smart Parking Assist will automatically control the steering wheel, vehicle speed and gear shift. The vehicle will move in the direction of the button pressed.
 - Whilst Remote Operation function is operating, if you let the button, the vehicle will stop and function control will pause. The function will start operating again when the button is pressed and held again.
2. Hold down the Forward (⏪) or Backward (⏩) button until the vehicle reaches the target location.
3. When Remote Operation is done, get in the vehicle with the smart key or press the Remote Start (⏻) button on the smart key from outside the vehicle.
 - The message will appear on the infotainment system screen. The vehicle will automatically shift to P (Park) and engage the parking brake.
 - When the Remote Start (⏻) button is pressed, the vehicle will turn off. If the driver is in the vehicle, the vehicle will retain ON position.

* NOTICE

- Remote Operation can control the vehicle remotely using the smart key outside the vehicle.
- Check that all smart keys are outside the vehicle when using Remote Operation function.
- Remote Operation function will operate only when the smart key is within 4 m (13 ft.) from the vehicle. If there is no vehicle movement even when the Forward or Backward button is pressed on the smart key, check the distance to the vehicle and press the button again.
- The detecting range of the smart key may vary depending on the surroundings that are affected by radio waves such as transmission tower, broadcast station, etc.
- When remotely moving forward using method (1), it is recognised as an exit situation, and the vehicle moves 4 m (13 ft.) to check for pedestrians, animals or objects around the vehicle. After confirmation, the steering wheel is controlled according to the condition ahead.
- When remotely moving forward using method (2), it is recognised as a parking situation, and will immediately control the steering wheel according to the condition ahead to assist with entering the parking space and aligning the vehicle. However, performance may reduce depending on the pedestrians, animals, shape of objects, location, etc. around the vehicle.
- For moving remotely backward, both method (1) and (2) aligns the steering

wheel first, and then will only move the vehicle straight.

▲ WARNING

- When using Remote Operation function, make sure that all passengers have gotten out of the vehicle.
- Before leaving the vehicle, close windows and sunroofs, and make sure the vehicle is off before locking the doors.
- If the vehicle's battery is discharged or Remote Smart Parking Assist malfunctions when parked in a narrow parking space, Remote Operation function will not operate. Always park your vehicle in a space wide enough for you to get in or out of your vehicle.
- Please note that depending on the parking space, you may not be able to exit from the space you have entered by using Remote Operation function.
- After parking, the surrounding may change due to the movement of surrounding vehicles. If this occurs, Remote Operation function may not operate.

Remote Smart Parking Assist operation status



| Operation Status | Smart key LED |
|------------------|--|
| Under control | Green LED Continuously blinks |
| Pause | Red LED Continuously blinks |
| Off | Red LED illuminates for 4 seconds and then turns off |
| Complete | Green LED illuminates for 4 seconds and then turns off |

*** NOTICE**

- Operation status by the hazard warning light may not be applicable based on the regulation of your country.



- If the smart key is not within the operating range from the vehicle (approximately 4 m (13 ft.)), the smart key LED will not illuminate or blink. Use the smart key within the operating range.

How to turn off Remote Operation function whilst operating

- Press the Parking/View () button or shift the gear except to P (Park) whilst the infotainment system screen guides the driver using method 2.
- Press the Parking Safety () button or select **Cancel** on the infotainment system screen.
- Press the Remote Start () button on the smart key whilst the vehicle is being controlled by Remote Operation function. Remote Operation function will turn off. At this time, the vehicle will turn off.
- Get on the vehicle with the smart key. Remote Operation function will turn off. At this time, the vehicle will remain on.

The function will pause in the following conditions when:

When Remote Operation function is paused, the vehicle will stop. If the condition that made the function to pause disappears, the function may operate again.

- There is a pedestrian, animal or object in the direction the vehicle is moving
- The door or tailgate is open
- The Forward () or Backward () button is not continuously pressed
- Simultaneously pressing multiple buttons on a smart key

- The smart key is not operated within 4 m (13 ft.) from the vehicle
- Button of another smart key is pressed in addition to the operating smart key (Excluding start button)
- Blind-Spot Collision-Avoidance Assist or Rear Cross-Traffic Collision-Avoidance Assist operates whilst the vehicle is being controlled in the reverse direction.
- The vehicle moves 7 m (22 ft.) whilst the smart key is pressed with Remote Operation function (maximum travel distance per button press)

The function will cancel in the following conditions when:

When Remote Operation function is cancelled, the vehicle will automatically stop, shift the gear to P (Park) and engage EPB (Electronic Parking Brake).

- The steering wheel is steered
- The gear is shifted whilst the vehicle is moving
- Operating EPB whilst the vehicle is moving
- The vehicle bonnet is open
- The brake pedal or accelerator pedal is depressed when all the doors are closed
- The smart key is outside the vehicle when the brake pedal is depressed whilst the driver's door is open
- Rapid acceleration occurs
- Vehicle skid occurs
- The wheel is stuck by an obstacle and cannot move
- Approximately 3 minutes and 50 seconds have past after Remote Operation function has started to operate

- The slope of the road exceeds the operational range
- The function is paused for more than 1 minute
- The total travel distance of the vehicle has exceeded 14 m (45 ft.) after Remote Operation function operation
- The steering wheel, gearshift, braking, and drive controls are not working normally
- There is a problem with the smart key or the smart key battery is low
- ABS, TCS or ESC system operates due to slippery road conditions
- The alarm of the Theft Alarm System sounds

Remote Smart Parking Assist malfunction and limitations

Remote Smart Parking Assist malfunction

Remote Smart Parking Assist check

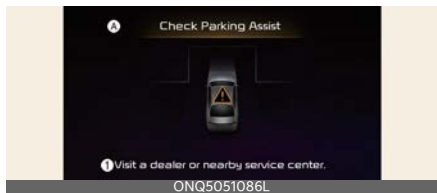

A: Check Parking Assist

1 Visit a dealer or nearby service centre.

When Remote Smart Parking Assist is not working properly, the **Check Parking Assist** warning message will appear on the infotainment system screen. If the message appears, stop using the function, and we recommend that the function be inspected by an authorised Kia dealer/service partner.

Remote Smart Parking Assist cancelled



A: **Parking Assist cancelled.**

1 Please refer to owner's manual.

When Remote Smart Parking Assist is operating, the function can be cancelled, and the **Parking Assist Cancelled** warning message may appear regardless of the parking order. Other messages may appear depending on the situations. Follow the instructions provided on the infotainment system screen whilst parking your vehicle with Remote Smart Parking Assist. Always look around and pay attention when using the function.

Remote Smart Parking Assist standby



A: **Parking Assist conditions Not Met**

1 Please refer to owner's manual.

When **Parking Assist conditions not met** message appears, when Parking/View (P) button has been pressed and held, Remote Smart Parking Assist is in standby. After a whilst, press and hold the Parking/View (P) button again to see if the function works.

The message appears even when the smart key's battery is low. Check the smart key battery level.

Limitations of Remote Smart Parking Assist

In the following circumstances, function performance to park or exit the vehicle may be limited, there may be a risk of collision, or Remote Smart Parking Assist may turn off. Park or exit the vehicle manually if necessary.

- An object is attached to the steering wheel
- The vehicle is installed with a snow chain, spare tyre or different size wheel
- Tyre pressure is lower or higher than the standard tyre pressure
- Your vehicle is loaded with cargo longer or wider than your vehicle or a trailer is connected to your vehicle
- There is a problem with the wheel alignment
- Your vehicle is leaned severely to one side
- Your vehicle is equipped with a trailer hitch
- The license plate is installed differently from the original location
- There is a person, animal or object above or below the ultrasonic sensor when Remote Smart Parking Assist is activated
- There is an obstacle such as a person, animal or object (trash can, bicycle, motorcycle, shopping cart, narrow pillar etc.) near the parking space
- There is a circular pillar or narrow pillar, or a pillar surrounded by objects such as fire extinguisher, etc. near the parking space

- The road surface is bumpy (kerbstone, speed bump, etc.)
- The road is slippery
- The parking space is near a vehicle with higher ground clearance or big, such as a truck, etc.
- The parking space is Inclined
- There is heavy wind
- Operating Remote Smart Parking Assist on uneven roads, gravel roads, bushes, etc.
- The performance of the ultrasonic sensor is affected by extremely hot or cold weather
- The ultrasonic sensor is covered with snow or water
- An object that generates ultrasonic waves is nearby
- A wireless device with a transmission function operates near the ultrasonic sensors
- Your vehicle is affected by another vehicle's Parking Distance Warning
- The sensor is mounted or positioned incorrectly by an impact to the bumper
- When the ultrasonic sensor cannot detect the following objects: Sharp or slim objects, such as ropes, chains or small poles
- Objects smaller than 100 cm (40 inches) in length and narrower than 14 cm (6 inches) in diameter
- Objects which tend to absorb sensor frequency, such as clothes, spongy material or snow

Remote Smart Parking Assist may not operate normally under the following circumstances:

- Parking on inclined road



Park manually when parking on inclines.

- Parking on uneven road



Remote Smart Parking Assist may cancel when the vehicle slips, or the vehicle cannot move due to road conditions such as pebbles or fragmented stones.

- Parking behind a truck



Do not use Remote Smart Parking Assist around vehicles with higher ground clearance, such as a bus, truck, etc. It may lead to an accident.

- Parking near a pillar



Remote Smart Parking Assist performance may reduce or collision with an

obstacle may occur when there is a narrow object, circular pillar, square pillar, or a pillar surrounded by objects such as a fire extinguisher, etc. near the parking space. The driver should park the vehicle manually.

- Parking in a parking space with a vehicle on one side only



If Remote Smart Parking Assist is used, when parking in a parking space with a vehicle only on one side, your vehicle may cross the parking line to avoid the parked vehicle.

- Parking diagonal



Remote Smart Parking Assist does not provide diagonal parking. Even if your vehicle was able to enter the parking space, do not use the function because the function cannot operate normally.

⚠ WARNING

- The driver is responsible for safe parking and exit when using Remote Smart Parking Assist.
- When using Remote Smart Parking Assist, stay out of the way in the direction the vehicle moves for your safety.
- Always check surroundings when using Remote Smart Parking Assist.

You may collide with pedestrians, animals, or objects if they are near the sensor or are in the sensor's blind spot area.

- A collision may occur if a pedestrian, animal, or object suddenly appears whilst Remote Smart Parking Assist is operating.
- Do not use Remote Smart Parking Assist when under the influence of alcohol.
- Do not let children or other people to use the smart key.
- If Remote Smart Parking Assist is used continuously for a long period, it may adversely affect Remote Smart Parking Assist performance.
- Remote Smart Parking Assist may not operate normally if the vehicle needs wheel alignment adjustment such as when the vehicle tilts to one side. We recommend that the vehicle be inspected by an authorised Kia dealer/service partner.
- Noise may be heard when braking occurs by Remote Smart Parking Assist or when the brake pedal is depressed by the driver.
- Remote Smart Parking Assist may suddenly apply the brake to avoid collision.
- Use Remote Smart Parking Assist only in a parking space that is large enough for the vehicle to move safely.

*** NOTICE**

- If the 3rd stage warning (continuous beep) of Forward/Reverse Parking Distance Warning sounds whilst Remote Smart Parking Assist is operating, it means the obstacle detected is close to your vehicle. At this time,

Remote Smart Parking Assist will temporarily stop operating. Make sure there are no pedestrians, animals, or objects around your vehicle.

- Depending on brake operation, the stop lights may come on whilst the vehicle is moving.
- If the vehicle is remotely started that has been parked in cold weather for a long time, the operation of Remote Smart Parking function may be delayed or cancelled depending on vehicle condition.

Declaration of conformity (if equipped)

The radio frequency components (Front Radar) complies:

For Taiwan

第十二條
經型式認證合格之低功率射頻電機，非經許可，公司、商號或使用者均不得擅自變更頻率、加大功率或變更原設計之特性及功能。

第十四條
低功率射頻電機之使用不得影響飛航安全及干擾合法通信；經發現有干擾現象時，應立即停用，並改善至無干擾時方得繼續使用。
前項合法通信，指依電信法規定作業之無線電通信。低功率射頻電機須忍受合法通信或工業、科學及醫療用電波輻射性電機設備之干擾。

ONQ5051043L

For Thailand



ONQ5051044L

For Indonesia

72511/SDPPI/2021
10239



ONQ5051045L

For Singapore

**Complies with
IMDA Standards**

DA105282

ONQ5051046L

For Europe and countries subject to CE certification

Trade mark or Trade name : Hyundai Mobis

MOBIS Parts Europe N.V.
Wilhelm-Fay-Strabe 51, Frankfurt Main, 65936, GermanyFrequency : 76-77 GHz
Max EIRP(Peak) :
Normal Resolution 27.60 dBm
High Resolution : 32.58 dBm

The antenna(s) must be installed such that a minimum separation distance of at least 20 cm is maintained between the radiator (antenna) and all persons at all times. This device must not be co-located or operating in conjunction with any other antenna or transmitter.

Hereby, Hyundai Mobis Co.,Ltd declares that the radio equipment type MAR320A is in compliance with Directive 2014/53/EU.

The full text of the EU declaration of conformity is available at the following internet address:
http://www.mobis-as.com/product_certificate.do

ONQ5052047L

For Ukraine



UA RF:3MOBS320A

ONQ5051088L

Hyundai Mobis Co.,TOB
Гангнам-гу 203, Тереран-ро Сеул 06141
Республика Корея
UNIT ASSY-FR RADAR
MAR320A

Частотний діапазон: 76 - 77 ГГц
Потужність передачі: 27.60 дБм (макс.) EIRP, 32.58 дБм (макс.) EIRP

справним Hyundai Mobis Co.,TOB заявляє, що тип р
адіообладнання MAR320A відповідає Технічному р
егламенту радіобладнання;
повний текст декларації про відповідність доступни
й на вебсайті

за такою адресою:

http://www.mobis-as.com/product_certificate.do

ONQ5052049L

For Moldova

Prin prezenta, Hyundai Mobis Co.,Ltd, declară că
tipul de echipamente radio MAR320A este în
conformitate cu Reglementarea tehnică „Punerea
la dispoziție pe piață a echipamentelor radio”.
Textul integral al declarației de conformitate este
disponibil la următoarea adresă de Internet:
http://www.mobis-as.com/product_certificate.do

ONQ5052053L

For Jordan

Hyundai Mobis Co.,Ltd
UNIT ASSY-FR RADAR
MAR320A

ONQ5051054L

For UAE



ONQ5051055L

For Ghana

NCA Approved: 5R0-1M-7E4-2AA

ONQ5051056L

For Serbia



For Russia



For Republic of South Africa



Model : MAR320A
 Hyundai Mobis
 Rating : 12V DC, 1.5A
 MADE IN KOREA
 Hyundai Mobis Co.,Ltd
 203, Teheran-ro, Gangnam-gu, Seoul, 06141,
 Republic of Korea
 Local representative : Proxy
 Local rep Address : Of. 216, bl.2, Obolenskoe road,
 Protvino, Moscow region, 142281
 Local rep contact : Tel. 7 (495) 369-00-84 , E-mail:
 proxy.russia@gmail.com

ONQ5051067L

For Zambia



For Oman

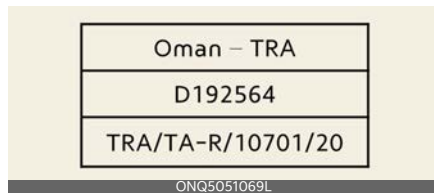

For Nigeria

Connection and use of this communications
 equipment is permitted by the Nigerian
 Communications Commission

ONQ5051064L

For United States and United States territories

The antenna(s) must be installed such
 that a minimum separation distance of at
 least 20 cm is maintained between the
 radiator (antenna) and all persons at all
 times. This device must not be co-located
 or operating in conjunction with any
 other antenna or transmitter.

ONQ5052180L

For Morocco

AGREE PAR L'ANRT MAROC
 Numéro d'agrément : MA00026B76ANRT2020
 Date d'agrément : 24/12/2020

ONQ5051065L

For Korea

- 1.상호 : 현대모비스㈜
- 2.기기명칭 및 모델명 : 특정소출력 무선기기(차량 충돌방지용 레이더 무선기기)/ MAR320A
- 3.제조사 및 제조국가 : 현대모비스/한국

ONQ5052149L

For Canada

This device complies with Innovation, Science and Economic Development Canada's licence-exempt RSS standard(s). Operation is subject to the following two conditions: (1) this device may not cause interference, and (2) this device must accept any interference, including interference that may cause undesired operation of the device.

Le présent appareil est conforme aux CNR d'Industrie Canada applicables aux appareils radio exempts de licence. L'exploitation est autorisée

- aux deux conditions suivantes:
- (1) l'appareil ne doit pas produire de brouillage, et
 - (2) l'utilisateur de l'appareil doit accepter tout brouillage radioélectrique subi, même si le brouillage est susceptible d'en compromettre le fonctionnement.

ONQ5052181L

For China

车辆驾驶辅助雷达系统型号: MAR320A
 执行标准: 信部无[2005]423号
 频率范围: 76-77 GHz
 发射功率: ≤55dBm (EIRP)
 天线类型: 集成型微带贴片阵列天线
 用户控制: 不可
 使用温度: +24.1 °C
 电压: DC 12.0 V

不得擅自更改发射频率、加发射功率(包括额外加发射功率放大器), 不得擅自外接天线或改用其它发射天线

使用时不得对各种合法的无线电通信业务产生有害干扰; 一旦发现有害干扰现象时, 应立即停止使用, 并采取有效措施消除干扰后方可继续使用

使用微功率无线电设备, 必须耐受各种无线电业务的干扰或工业、科学及医疗应用设备的辐射干扰

机场等的电磁环境保护区域内使用微功率设备, 应当遵守电磁环境保护及相关行业主管部门的规定

ONQ5052182L

For Malaysia



ONQ5051070L

For Israel

הנאם מיוחדים והערות המשד:
 א. השימוש במכשיר הינו על בסיס "משנ" ופגור משרתן הפעלה אלחוטי.
 כלומר - לא מוגן מהפרעות וללא הסרעה למערכות אחרות המפעלות כדיון.
 ב. רק "מפעלה בקו" לשימוש עקרי של הלקוח בלבד, היחיד סגור משרתן הפעלה אלחוטי.
 מתן "שרות בקו" לצד ג. מתייב ישותן מיוחד משרד התקשורת.
 ג. אסור להחליף את האנטנה המקורית של המכשיר, ולא לעשות בו כל שינוי טכני אחר.

שם המוצר היעודי והמסחר: יציד לרכב - רדאר

שם המוצר: Hyundai Mobis - יחדא מוביס

שם הרבואן ומכתובת: טלקאר חברת ביל"מ

המסנר 2

תל אביב - יפו

שם הדגם: MAR320A

ארץ יצור: קוריאה

הוראת ביטוח: Hyundai Mobis MAR320A

יש למעול עם כללי הביטוחות הבאים:

אין לפתוח את המוצר, במקרה של בעיה כלשהי, יש לפנות למעבדת השרות הקרובה.

יש להרוחיק את המוצר מנוזלים.

במקרה של ריח מוזר, רעשים שאינם ממוצא, יש לתקוף מיידידית מהמוצר אספקה

ולפנות למעבדת שירות.

אזהרה:

יש להתחקר את האנטנה כך שתחזק מרחק המרדה מינימלי של לפחות 20 מ"מ בין האנטנה לכל האנשים בכל עת.

ONQ5051094L

For Brazil



17417-20-04902

ONQ5051074L

Este equipamento não tem direito à proteção contra interferência prejudicial e não pode causar interferência em sistemas devidamente autorizados

ONQ5051076L

For Mexico

IFETEL:RLVHYMA21-1124

"La operación de este equipo está sujeta a las siguientes dos condiciones:

(1) es posible que este equipo o dispositivo no cause interferencia perjudicial y (2) este equipo o dispositivo debe aceptar cualquier interferencia, incluyendo la que pueda causar su operación no deseada."

ONQ5051078L

For Paraguay



NR : 2021-01-I-0013

ONQ5051079L

Hyundai Mobis Co.,Ltd
MAR320A
Hyundai Mobis

For Argentina



RAMATEL

H-26025

ONQ5051081L

For Pakistan

Approved by PTA
TAC NO : 9.28/2021



ONQ5051082L

For Benin

AGREE PAR L'ATRPT BENIN

numéro d'agrément:

N03B/ARCEP/SE/DJPC/DAR/GU/2021

Date d'agrément: 26 FEB 2021

ONQ5051084L

For United Kingdom

MOBIS Parts Europe N.V.
Ansley Hall Drive, Birch Coppice Business Park
Dordon, Tamworth, B78 1SQ, UK

Frequency : 76-77 GHz
Max EIRP(Peak) :
Normal Resolution 27,60 dBm
High Resolution : 32,58 dBm

Simplified UK Declaration of Conformity

Hereby, Hyundai Mobis Co.,Ltd declares that the radio equipment type MAR320A is in compliance with the Radio Equipment Regulations 2017. The full text of the UK declaration of conformity is available at the following internet address:
http://www.mobis-as.com/product_certificate.do

ONQ5052153L



ONQ5052179L

For Mauritania

AGREE PAR L'ARE MAURITANIE
 Numéro d'agrément : 095B/ARE/2021
 Date d'agrément :27/05/2021

ONQ5052154L

For Sierra Leone



TAN : 2021-002-0067

ONQ5052155L

The radio frequency components (Rear Corner Radar) complies (Type A):

For United States and United States territories



OCV051263N

FCC ID : LTQH5TR

This device complies with Part 15 of the FCC Rules. Operation is subject to the following two conditions:

(1) this device may not cause harmful interference, and

(2) this device must accept any interference received, including interference that may cause undesired operation.

CAUTION TO USERS

Changes or modifications not expressly approved by the party responsible for compliance could void the user's authority to operate the equipment.

ONQ5051136N

For Singapore

Complies with
 IMDA Standards
 DA 103787

ONQ5052046L

For Malaysia



ONQ5052070L

For Japan

This device is granted pursuant to the Japanese Radio Law

under the grant ID n° : 203-JN1053

This device should not be modified (otherwise the granted designation number will become invalid)

本製品は、電波法に基づく特定無線設備の技術基準適合証明などを受けております。認証番号: 203-JN1053

本製品の改造は禁止されています。(適合証明番号などが無効となります。)

OGL3051270L

For Europe and CE certified countries

Declaration of Conformity
Radiocontrolled Vehicle components



Hereby, APTIV, 42367 Wuppertal declares that this HSTR is in compliance with the essential requirements and other relevant provisions of Directive 2014/53/EU (RED).
The original declaration of conformity can be accessed at the following link :
www.aptiv.com/automotive-homologation

frequency band 76-77 GHz
Maximum Output Power 30 dBm (1.0 W)

ONQ5052166L

For Nigeria

Connection and use of this communications equipment is permitted by the Nigerian Communications Commission

ONQ5052064L

For United Kingdom



Hereby, APTIV, 42367 Wuppertal declares that this HSTR is in compliance with the essential requirements and other relevant provisions of Directive Radio Equipment Regulations 2017.

frequency band 76-77 GHz
Maximum Output Power 30 dBm (1.0 W)

ONQ5EP051154L

For Mexico

IFETEL: RCPAPH519-1602

“La operación de este equipo está sujeta a las siguientes dos condiciones:
(1) es posible que este equipo o dispositivo no cause interferencia perjudicial y (2) este equipo o dispositivo debe aceptar cualquier interferencia, incluyendo la que pueda causar su operación no deseada.”

OGL3051265L

For Australia



ONQ5EP051153L

For Brazil



XXXX-XX-XXXX

13265-20-12277

ONQ5052171L

Este equipamento opera em caráter secundário, isto é, não tem direito à proteção contra interferência prejudicial, mesmo de estações do mesmo tipo, e não pode causar interferência a sistemas operando em caráter primário.

ONQ5052172L

For Serbia



For Zambia



For Oman



For Morocco



For Ghana



For Republic of South Africa



For Pakistan



For Paraguay



For Senegal



For Indonesia

75710/SDPPI/2021
10976



ONQ5052169L

For Jordan

TRC/31/7635/2020

ONQ5052168L

For Taiwan



電信法第 48 條, 低功率電波輻射性電機管理辦法
第十二條
經型式認證合格之低功率射頻電機, 非經許可, 公司、商號或使用者均不得擅自變更頻率、加大功率或變更原設計之特性及功能。
第十四條
低功率射頻電機之使用不得影響飛航安全及干擾合法通信; 經發現有干擾現象時, 應立即停用, 並改善至無干擾時方得繼續使用。
前項合法通信, 指依電信法規定作業之無線電通信。低功率射頻電機須忍受合法通信或工業、科學及醫療用電波輻射性電機設備之干擾。
Article 12
Without permission, any company, firm or user shall not alter the frequency, increase the power, or change the characteristics and functions of the original design of the certified lower power frequency electric machinery.
Article 14
The application of low power frequency electric machineries shall not affect the navigation safety nor interface a legal communication, if an interference is found, the service will be suspended until improvement is made and the interference no longer exist.

ONQ5052170L

For Israel

המכשיר מתאים לתדירות השימוש
למעשה יש להימנע משימוש ברכיבי המכשיר
א. המכשיר יבטיח את רמת הביטחון של המכשיר ויבטיח את הפעולה האמורה
ב. אין להשתמש במכשיר לצורך שימוש אחר או שימוש אחר מזה המיועד למכשיר
ג. אין להשתמש במכשיר לצורך שימוש אחר מזה המיועד למכשיר
ד. אין להשתמש במכשיר לצורך שימוש אחר מזה המיועד למכשיר

תקן מספר : 63-67459
א. המכשיר יבטיח את רמת הביטחון של המכשיר ויבטיח את הפעולה האמורה.
ב. אין להשתמש במכשיר לצורך שימוש אחר או שימוש אחר מזה המיועד למכשיר.
ג. אין להשתמש במכשיר לצורך שימוש אחר מזה המיועד למכשיר.
ד. אין להשתמש במכשיר לצורך שימוש אחר מזה המיועד למכשיר.

OGL3051277L

For Thailand



เครื่องวิทยุคมนาคมนี้ ได้รับยกเว้น ไม่ต้องได้
รับใบอนุญาตให้มี ใช้ซึ่งเครื่องวิทยุคมนาคม
หรือตั้งสถานีวิทยุคมนาคมตามประกาศ กสทช.
เรื่อง เครื่องวิทยุคมนาคม และสถานีวิทยุ
คมนาคมที่ได้รับยกเว้นไม่ต้องได้รับใบอนุญาต
วิทยุคมนาคมตามพระราชบัญญัติวิทยุคมนาคม
พ.ศ. 2498



nabp. | โทรคมนาคม
กำกับดูแลเพื่อประชาชน
Call Center 1200 (InSW5)

OGL3051276L

For Ukraine



UA RF: 1APT V H5TR

OGL3051266L

справжнім (найменування виробника) заявляє, що тип радіобладнання (позначення типу радіобладнання) відповідає Технічному регламенту радіобладнання:

повний текст декларації про відповідність доступний на веб-сайті за такою адресою:

www.ap tiv.com/automotive-homologation

OGL3051267L

For Philippines



NTC

Type Approved

No. ESD-1920939C

ONQ5052164L

For UAE

TRA
REGISTERED No:
ER78239/20

DEALER No:
DA0062437/11

ONQ5052167L

For China

车辆驾驶辅助雷达系统型号：H5TR

执行标准：汽车雷达无线电管理暂行规定 2021 181号文

频率范围：76-77 GHz

发射功率：等效全向辐射功率 (EIRP) 30dBm

天线类型：印刷阵列天线

用户控制：不可

使用温度：-40°C ~ +85°C

电压：DC 12.0V

OMIT ID：2022LP9112

不得擅自更改发射频率、加大发射功率（包括额外加装射频功率放大器），不得擅自外接天线或改用其它发射天线

使用时不得对各种合法的无线电通信业务产生有害干扰；一旦发现有干扰现象时，应立即停止使用，并采取措施消除干扰后方可继续使用

使用微功率无线电设备，必须耐受各种无线电业务的干扰或工业、科学及医疗应用设备的辐射干扰

机场等的电磁环境保护区域内使用微功率设备，应当遵守电磁环境保护及相关行业主管部门的规定

ONQ5053189L

The radio frequency components (Rear Corner Radar) complies (Type B):

For United States and United States territories



OCV051263N

FCC ID: LTQ2H5TR

This device complies with Part 15 of the FCC Rules. Operation is subject to the following two conditions:

(1) this device may not cause harmful interference, and

(2) this device must accept any interference received, including interference that may cause undesired operation.

CAUTION TO USERS

Changes or modifications not expressly approved by the party responsible for compliance could void the user's authority to operate the equipment.

ONQ5P052042N

For Singapore

Complies with
IMDA Standards
DA 103787

ONQ5052046L

For Malaysia



MCMC

CIDF17000143

ONQ5052070L

For Japan

This device is granted pursuant to the Japanese Radio Law under the grant ID n° : 203-JN1244
This device should not be modified (otherwise the granted designation number will become invalid)

本製品は、電波法に基づく特定無線設備の技術基準適合証明などを受けております。 認証番号: 203-JN1053
本製品の改造は禁止されています。(適合証明番号などが無□となります。)

ONQ5052163L

For Europe and CE certified countries

Declaration of Conformity
Radiocontrolled Vehicle components



Hereby, APTIV, 42367 Wuppertal declares that this ZH5TR is in compliance with the essential requirements and other relevant provisions of Directive 2014/53/EU (RED).
The original declaration of conformity can be accessed at the following link : www.aptiv.com/automotive-homologation

frequency band 76-77 GHz
Maximum Output Power 30 dBm (1.0 W)

ONQ5052158L

For United Kingdom



Hereby, APTIV, 42367 Wuppertal declares that this ZH5TR is in compliance with the essential requirements and other relevant provisions of Directive Radio Equipment Regulations 2017.

frequency band 76-77 GHz
Maximum Output Power 30 dBm (1.0 W)

ONQ5052160L

For Australia



ONQ5EP051153L

For Nigeria

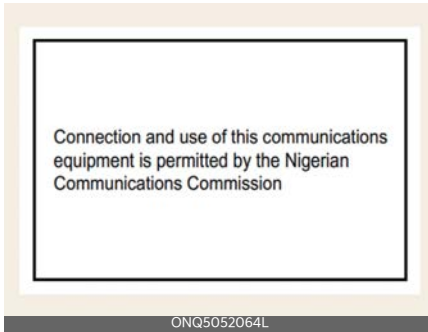

For Serbia



For Mexico

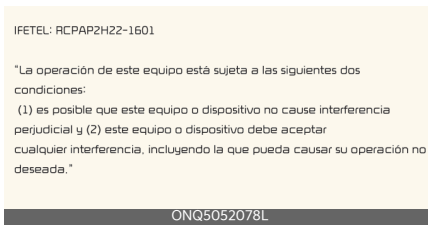

For Morocco



For Brazil



For Republic of South Africa



Este equipamento opera em caráter secundário, isto é, não tem direito à proteção contra interferência prejudicial, mesmo de estações do mesmo tipo, e não pode causar interferência a sistemas operando em caráter primário.

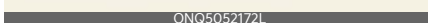

For Paraguay



7

For Zambia



ZMB/ZICTA/TA/2022/3/16

ONQ5052063L

For Oman

| |
|-------------------|
| Oman – TRA |
| D172299 |
| TRA/TA-R/13542/22 |

ONQ5052069L

For Ghana

NCA approved: 7E6-M1-X63-5RD

ONQ5052157L

For Pakistan



Approved by PTA
TAC NO: 9.539/2022

ONQ5052082L

For Senegal

AGREE PAR ARTP SENEGAL

Numéro d’agrément : 072229/AG/ER

ONQ5052159L

For Indonesia

83300/SDPPI/2022
10976



ONQ5052045L

For Jordan

TRC/31/9883/2022

ONQ5052054L

For Taiwan



CCAF22LP0950T2

電信法第 4B 條, 低功率電波輻射性電機管理辦法
第十二條
經型式認證合格之低功率射頻電機, 非經許可, 公司、商號或使用者均不得擅自變更頻率、加大功率或變更原設計之特性及功能。
第十四條
低功率射頻電機之使用不得影響飛航安全及干擾合法通信; 經發現有干擾現象時, 應立即停用, 並改善至無干擾時方得繼續使用。
前項合法通信, 指依電信法規定作業之無線電通信。低功率射頻電機須忍受合法通信或工業、科學及醫療用電波輻射性電機設備之干擾。
Article 12
Without permission, any company, firm or user shall not alter the frequency, increase the power, or change the characteristics and functions of the original design of the certified lower power frequency electric machinery.
Article 14
The application of low power frequency electric machineries shall not affect the navigation safety nor interface a legal communication, if an interference is found, the service will be suspended until improvement is made and the interference no longer exist.

ONQ5052162L

For Israel

14. מידע מיוחדים הנוגעים הישראל
 לפני השימוש יראו היטב את המפרט של המוצר יורדיב מובדקת, בה יזוהו רישום כי:
 א. הישיבות במכשיר זהות על בסיס "סמל" מסווג מרשימן הפעלה אלוהיטי
 ב. כי מוצר זה מתקשרת וכלה התקנה למערכות אחרות המעולות כדור
 ג. כי המערכת יודית מרשימת עמית של הלכות בלבד, תודית מסוג מרשימן הפעלה אלוהיטי.
 מות: "ישירות כוכי" לבד ג. סמלית מרשימן מיוחד מסווגת התקשרות.
 ג. אסור להעתיק את האנמטה המוקדמת של המכשיר, ולא לפעולת כלל שינוי סמל אחר.

תקת מספר: 63-66570

א. המכשיר במכשיר זהות על בסיס "סמל" ומסור מרשימן הפעלה אלוהיטי.
 כלומר - לא מונן מהמפרט וכל המפרט למערכות אחרות המעולות כדור
 ב. כי "פעולה בוק" לשימוש עמית של הלכות בלבד, תודית מסוג מרשימן הפעלה אלוהיטי.
 מות "שרות בוק" לבד ג. סמלית מרשימן מיוחד מסווגת התקשרות.
 ג. אסור להעתיק את האנמטה המוקדמת של המכשיר, ולא לפעולת כלל שינוי סמל אחר.
 ד. האשור לכל תקת אחר רק עבר בוד אלוהיטי, "operating frequencies of the device".
 הפעול בתחום הדורם של
 הסמן השרור שלו את עולה על "output power of the device"

ONQ5052094L

For Thailand

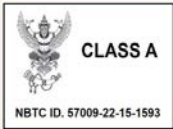

CLASS A
 NBTC ID. 57009-22-15-1593

1) เครื่องโทรคมนาคมและอุปกรณ์ มีความสอดคล้องตามมาตรฐานหรือข้อกำหนดของ กสทช.
 2) เครื่องวิทยุคมนาคมนี้มีระดับการแผ่คลื่นแม่เหล็กไฟฟ้าสอดคล้องตามมาตรฐานความปลอดภัยต่อสุขภาพของมนุษย์จากการใช้เครื่องวิทยุคมนาคมที่คณะกรรมการกิจการโทรคมนาคมแห่งชาติประกาศกำหนด

ONQ5052044L

For Ukraine



UA RF: 1APT V 2HTR

ONQ5053186L

справжнім (найменування виробника) заявляє, що тип радіообладнання (позначення типу радіообладнання) відповідає Технічному регламенту радіообладнання:
 повний текст декларації про відповідність доступний на веб-сайті за такою адресою:
www.aptv.com/automotive-homologation

ONQ5053187L

For Philippines



NTC

Type Approved
 No. ESD-RCE-2229725

ONQ5052165L

For UAE



TDRA - United Arab Emirates
 Dealer ID: DA000243711
 TA RTTE: ER00574-22
 Model: 2HSTR
 Product Type: Vehicle Radar



ONQ5052156L

For China

车辆驾驶辅助雷达系统型号：2H5TR

执行标准：汽车雷达无线电管理暂行规定 2021 181号文

频率范围：76-77 GHz

发射功率：等效全向辐射功率(EIRP) 30dBm

天线类型：印刷阵列天线

用户控制：不可

使用温度：-40°C - +85°C

电压：DC 12.0V

CMII T ID：2022LJ18795

不得擅自更改发射频率、加大发射功率（包括额外加装射频功率放大器），不得擅自外接天线或改用其它发射天线

使用时不得对各种合法的无线电通信业务产生有害干扰；一旦发现有害干扰现象时，应立即停止使用，并采取相应措施消除干扰后方可继续使用

使用微功率无线电设备，必须耐受各种无线电业务的干扰或工业、科学及医疗应用设备的辐射干扰

机场等的电磁环境保护区内使用微功率设备，应当遵守电磁环境保护及相关行业主管部门的规定

ONQ5053188L

| | |
|---|-------------|
| Road warning | 8-3 |
| • Hazard warning flasher..... | 8-3 |
| In case of an emergency whilst driving | 8-3 |
| • If the vehicle stalls whilst driving..... | 8-3 |
| • If the engine stalls at a crossroad or crossing..... | 8-3 |
| • If you have a flat tyre whilst driving..... | 8-3 |
| If the engine does not start | 8-4 |
| • If engine does not turn over or turns over slowly..... | 8-4 |
| • If engine turns over normally but does not start..... | 8-4 |
| Emergency starting | 8-5 |
| • Jump-starting..... | 8-5 |
| • Push-starting..... | 8-6 |
| If the engine overheats | 8-6 |
| • Cooling down the vehicle..... | 8-6 |
| • If the cooling fan does not work..... | 8-7 |
| • If the coolant is running out..... | 8-7 |
| • If the water pump drive belt is broken..... | 8-7 |
| • If overheating happens again..... | 8-7 |
| Tyre Pressure Monitoring System (TPMS) | 8-8 |
| • Low tyre pressure telltale..... | 8-9 |
| • Tyre Pressure Monitoring System (TPMS) malfunction indicator..... | 8-10 |
| • Changing a tyre with TPMS..... | 8-11 |
| If you have a flat tyre (with spare tyre) | 8-12 |
| • Removing and storing the spare tyre..... | 8-12 |
| • Changing tyres..... | 8-13 |
| • Important - use of compact spare tyre..... | 8-15 |
| • Jack label..... | 8-17 |
| Towing | 8-21 |
| • Towing service..... | 8-21 |

8 What to do in an emergency

- Emergency towing..... 8-22
- Emergency commodity 8-24**
- ERA-GLONASS emergency call 8-24**
- ERA-GLONASS system..... 8-25

What to do in an emergency

Road warning

When in an emergency situation occurs whilst driving or when you park by the edge of the roadway, you must alert approaching or passing vehicles to be careful as they pass. For this, you should use the hazard warning flasher.

Hazard warning flasher

The hazard warning flasher serves as a warning to other drivers to exercise extreme caution when approaching, overtaking, or passing your vehicle.



Condition(s)

- When in an emergency situation occurs whilst driving
- Parking by the edge of the roadway

Operation

1. Push the hazard warning flasher switch.

* INFORMATION

- The hazard warning flasher operates whether your vehicle is running or not.
- The turn signals do not work when the hazard flasher is on.

In case of an emergency whilst driving

If the vehicle stalls whilst driving

Operation

1. Reduce the speed and keep a straight line.
2. Stop the vehicle to a safe place.
3. Turn the hazard warning flasher on.
4. Start the vehicle again.

If the engine still does not start, contact a professional workshop or seek other qualified assistance. Kia recommends to call an authorised Kia dealer/service partner.

If the engine stalls at a crossroad or crossing

Operation

1. Change the gear to N (Neutral).
2. Push the vehicle to a safe place.

If you have a flat tyre whilst driving

Operation

1. Reduce the speed slowly and keep a straight line.
2. Stop the vehicle to a safe leveled place away from traffic.
3. Turn the hazard warning flasher on.
4. Set the parking brake.
5. Change the gear to P (Parking).
6. Have all passengers get out of the vehicle away from traffic.

Refer to "If you have a flat tyre (with spare tyre)" on page 8-12.

If the engine does not start

* INFORMATION

When the engine does not start, first check to see how much fuel there is and whether the battery is discharged.

If engine does not turn over or turns over slowly

Operation

1. Set the parking brake.
2. Change the gear to N or P.
3. Check if the battery and starter connections are clean and tight.
 - The battery is discharged if the interior light dims or goes out when you start the vehicle.

⚠ WARNING

If the engine does not start, do not push or pull the vehicle to start it. This could result in a collision or cause other damage. In addition, push or pull starting may cause the catalytic converter to be overloaded and create a fire hazard.

* NOTICE

Do not start the vehicle by pulling or pushing. Refer to "Jump-starting" on page 8-5.

- Fuel line in the engine compartment.

If the engine still does not start, contact a professional workshop or seek other qualified assistance. Kia recommends to call an authorised Kia dealer/service partner.

If engine turns over normally but does not start

Operation

1. Check the following:
 - Fuel level. Add fuel if necessary.
 - Ignition coils and spark plug connectors. Reconnect any that may be disconnected or loose.

Emergency starting

Jump-starting

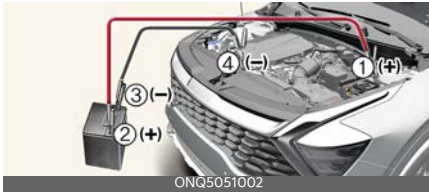

Condition(s)

- When the vehicle will not start due to low battery power, you may need to jump start the vehicle.

Operation

1. Make sure the booster battery is 12-volt and that its negative terminal is grounded. If the booster battery is in another vehicle, do not allow the vehicles to come in contact.
2. Turn off all unnecessary electrical loads.
3. Connect the jumper cables in the exact sequence shown in the illustration.
 - Connect one end of a jumper cable to the positive terminal of the discharged battery (1).
 - Connect the other end to the positive terminal of the booster battery (2).
 - Proceed to connect one end of the other jumper cable to the negative terminal of the booster battery (3), then the other end to a solid, stationary, metallic point away from the battery (4). Do not allow the jumper cables to contact anything except the correct battery terminals or the correct ground. Do not lean

over the battery when making connections.

4. If connected with the other vehicle, start the vehicle with the booster battery first and let it run at 2,000 rpm for several minutes.
5. Start the vehicle with the discharged battery.
6. If the engine starts, disconnect one end of the negative terminal of the booster battery (3), then other end of the positive terminal of the booster battery (2) and the discharged battery (1). If the cause of your battery discharging is not apparent, you should have your vehicle checked by a professional workshop. Kia recommends to visit an authorised Kia dealer/service partner.

⚠ WARNING

- Keep all flames or sparks away from the battery. The battery produces hydrogen gas which may explode if exposed to flame or sparks. If these instructions are not followed exactly, serious personal injury and damage to the vehicle may occur! If you are not sure how to follow this procedure, seek qualified assistance. Automobile batteries contain sulfuric acid. This is poisonous and highly corrosive. When jump starting, wear protective glasses and be careful not to get acid on yourself, your clothing or on the vehicle.
- Do not attempt to jump start the vehicle if the discharged battery is frozen or if the electrolyte level is low; the battery may rupture or explode.
- Do not allow the (+) and (-) jumper cables to touch. It may cause sparks.
- Never attempt to check the electrolyte level of the battery as this may cause

the battery to rupture or explode causing serious injury.

⚠ CAUTION

Use only a 12-volt jumper system. You can damage a 12-volt starting motor, ignition system, and other electrical parts beyond repair by use of a 24- volt power supply (either two 12-volt batteries in series or a 24-volt motor generator set).

*** NOTICE**

Do not connect the jumper cable from the negative terminal of the booster battery to the negative terminal of the discharged battery. This can cause the discharged battery to overheat and crack, releasing battery acid. Make sure to connect one end of the jumper cable to the negative terminal of the booster battery, and the other end to a metallic point, far away from the battery.

Push-starting

Vehicles equipped with automatic transmission cannot be push-started, and only jump-starting can be applied. Refer to "Jump-starting" on page 8-5.

⚠ WARNING

Never tow a vehicle to start it. When the engine starts, the vehicle can suddenly surge forward and could cause a collision with the tow vehicle.

If the engine overheats

*** INFORMATION**

When the temperature gauge indicates overheating, loss of power or a loud pinging, knocking noise will occur, being the engine too hot.

Cooling down the vehicle

Operation

1. Stop the vehicle to a safe place.
2. Turn the hazard warning flasher on.
3. Set the parking brake.
4. Change the gear to P (Park).
5. If the air conditioning is on, turn it off.
6. Check the following:
 - Engine cooling fan
 - Water pump drive belt
 - Belt tension
 - Leaks of the radiator, hoses or under the vehicle (If the air conditioning had been in use, it is normal for cold water to be draining from it when you stop).
7. Wait until the engine temperature returns normal.
8. Proceed with caution and keep an eye on further signs of overheating.

If the cooling fan does not work

Operation

- Stop the engine.

If the coolant is running out

Operation

1. Stop the engine.
2. Do not open the bonnet.
3. Wait until coolant has stopped running or the steam stops.
4. Add enough coolant to the reservoir.

If the water pump drive belt is broken

Operation

1. Stop the engine.
2. Contact a professional workshop or seek other qualified assistance. Kia recommends to call an authorised Kia dealer/service partner.

If overheating happens again

Operation

- Contact a professional workshop or seek other qualified assistance. Kia recommends to call an authorised Kia dealer/service partner.

CAUTION

- Serious loss of coolant indicates there is a leak in the cooling system and this should be checked as soon as possible by a professional workshop. Kia recommends to visit an authorised Kia dealer/service partner.
- When the engine overheats from low engine coolant, suddenly adding engine coolant may cause cracks in the engine. Add engine coolant slowly in small quantities to prevent damage.

WARNING



• Whilst the engine is running, keep hair, hands and clothing away from the fan and drive belts to prevent injury.

• Do not remove the radiator cap when the engine is hot. This may result in coolant being blown out of the opening and cause serious burns.

Tyre Pressure Monitoring System (TPMS) (if equipped)



- 1 Low tyre pressure telltale /TPMS malfunction indicator
- 2 Low tyre pressure position telltale (Shown on the LCD display)

Check tyre pressure

- You can check the tyre pressure in the assist mode on the cluster.
 - Refer to "User settings mode" on page 4-49.
- Tyre pressure is displayed 1~2 minutes later after driving.
- If tyre pressure is not displayed when the vehicle is stopped, "Drive to display" message displays. After driving, check the tyre pressure.
- You can change the tyre pressure unit in the user settings mode on the cluster.
 - psi, kpa, bar (Refer to "User settings mode" on page 4-49.

Each tyre, including the spare (if provided), should be checked monthly when cold and inflated to the inflation pressure recommended by the vehicle manufacturer on the vehicle placard or tyre inflation pressure label.

(If your vehicle has tyres of a different size than the size indicated on the vehicle placard or tyre inflation pressure label, you should determine the proper tyre inflation pressure for those tyres.) As an added safety feature, your vehicle has been equipped with a tyre pressure monitoring system (TPMS) that appears a low tyre pressure telltale when one or more of your tyres is significantly under-inflated. Accordingly, when the low tyre pressure telltale appears, you should stop and check your tyres as soon as possible, and inflate them to the proper pressure. Driving on a significantly under-inflated tyre causes the tyre to overheat and can lead to tyre failure. Under-inflation also reduces fuel efficiency and tyre tread life, and may affect the vehicle's handling and stopping ability.

Please note that the TPMS is not a substitute for proper tyre maintenance, and it is the driver's responsibility to maintain correct tyre pressure, even if under-inflation has not reached the level to trigger illumination of the TPMS low tyre pressure telltale.

Your vehicle has also been equipped with a TPMS malfunction indicator to indicate when the system is not operating properly. The TPMS malfunction indicator is combined with the low tyre pressure telltale. When the system detects a malfunction, the telltale will flash for approximately 1 minute and then remain continuously appeared. This sequence will continue upon subsequent vehicle start-ups as long as the malfunction exists. When the TPMS malfunction indicator remains appeared after blinking for approximately 1 minute, the system may not be able to

detect or signal low tyre pressure as intended.

TPMS malfunctions may occur for a variety of reasons, including the installation of replacement or alternate tyres or wheels on the vehicle that prevent the TPMS from functioning properly. Always check the TPMS malfunction telltale after replacing one or more tyres or wheels on your vehicle to ensure that the replacement or alternate tyres and wheels allow the TPMS to continue to function properly.

*** NOTICE**

If any of the below happens, have the system checked by a professional workshop. Kia recommends to visit an authorised Kia dealer/service partner.

1. The low tyre pressure telltale/ TPMS malfunction indicator do not appear for 3 seconds when the ignition switch is turned to the ON position or engine is running.
2. The TPMS malfunction indicator remains appeared after blinking for approximately 1 minute.
3. The Low tyre pressure position telltale remains appeared.

Low tyre pressure telltale (!)

Low tyre pressure position telltale



A: Low tyre pressure

When the tyre pressure monitoring system warning indicators are appeared and warning message displayed on the cluster LCD display, one or more of your tyres is significantly under-inflated. The low tyre pressure position telltale light will indicate which tyre is significantly under-inflated by illuminating the corresponding position light.

If either telltale appears, immediately reduce your speed, avoid hard cornering and anticipate increased stopping distances. You should stop and check your tyres as soon as possible. Inflate the tyres to the proper pressure as indicated on the vehicle's placard or tyre inflation pressure label located on the driver's side centre pillar outer panel. If you cannot reach a service station or if the tyre cannot hold the newly added air, replace the low pressure tyre with a spare tyre.

If you drive the vehicle for about 10 minutes at speeds above 25 km/h after replacing the low pressure tyre with the spare tyre, one of the following will happen:

- The TPMS malfunction indicator may blink for approximately 1 minute and then remain continuously appeared because the TPMS sensor is not mounted on the spare wheel.

(changed tyre equipped with a sensor not in the vehicle)

- The TPMS malfunction indicator will remain continuously appeared whilst driving because the TPMS sensor is not mounted on the spare wheel. (changed tyre equipped with a sensor in the vehicle)

⚠ WARNING

Low pressure damage

Significantly low tyre pressure makes the vehicle unstable and can contribute to loss of vehicle control and increased braking distances.

Continued driving on low pressure tyres can cause the tyres to overheat and fail.

⚠ CAUTION

- In winter or cold weather, the low tyre pressure telltale may appeared if the tyre pressure was adjusted to the recommended tyre inflation pressure in warm weather. It does not mean your TPMS is malfunctioning because the decreased temperature leads to a lowering of tyre pressure.
- When you drive your vehicle from a warm area to a cold area or from a cold area to a warm area, or the outside temperature is higher or lower, you should check the tyre inflation pressure and adjust the tyres to the recommended tyre inflation pressure.
- When filling tyres with more air, conditions to turn off the low tyre pressure telltale may not be met. This is because a tyre inflator has a margin of error in performance. The low tyre pressure telltale will be turned off if the tyre pressure is above the recommended tyre inflation pressure.

Tyre Pressure Monitoring System (TPMS) malfunction indicator (!)

The TPMS malfunction indicator will appear after it blinks for approximately one minute when there is a problem with the Tyre Pressure Monitoring System.

In this case, have the system checked by a professional workshop to determine the cause of the problem. Kia recommends to visit an authorised Kia dealer/service partner.

⚠ CAUTION

- The TPMS malfunction indicator may blink for approximately 1 minute and then remain continuously appeared if the vehicle is moving around electric power supply cables or radios transmitter such as at police stations, government and public offices, broadcasting stations, military installations, airports, or transmitting towers, etc. This can interfere with normal operation of the Tyre Pressure Monitoring System (TPMS).
- The TPMS malfunction indicator may blink for approximately 1 minute and then remain continuously appeared if snow chains are used or some separate electronic devices such as notebook computer, mobile charger, remote starter or navigation etc., are used in the vehicle. This can interfere with normal operation of the Tyre Pressure Monitoring System (TPMS).

*** NOTICE**

If there is a malfunction with the TPMS, the low tyre pressure position telltale will not be displayed even though the vehicle has an underinflated tyre.

Changing a tyre with TPMS

If you have a flat tyre, the low tyre Pressure and Position telltales will come on. In this case, have the system checked by a professional workshop. Kia recommends to visit an authorised Kia dealer/service partner.

CAUTION

We recommend that you use the sealant approved by Kia.

The sealant on the tyre pressure sensor and wheel shall be eliminated when you replace the tyre with a new one.

Each wheel is equipped with a tyre pressure sensor mounted inside the tyre behind the valve stem. You must use TPMS specific wheels. Have your tyres serviced by a professional workshop. Kia recommends to visit an authorised Kia dealer/service partner.

If you drive the vehicle for about 10 minutes at speeds above 25 km/h after replacing the low pressure tyre with the spare tyre, one of the following will happen:

- The TPMS malfunction indicator may blink for approximately 1 minute and then remain continuously appeared because the TPMS sensor is not mounted on the spare wheel. (changed tyre equipped with a sensor not in the vehicle)
- The TPMS malfunction indicator will remain continuously appeared whilst driving because the TPMS sensor is not mounted on the spare wheel. (changed tyre equipped with a sensor in the vehicle)

You may not be able to identify a low tyre by simply looking at it. Always use a good quality tyre pressure gauge to

measure the tyre's inflation pressure. Please note that a tyre that is hot (from being driven) will have a higher pressure measurement than a tyre that is cold (from sitting stationary for at least 3 hours and driven less than 1 mile (1.6 km) during that 3 hour period).

A cold tyre means the vehicle has been sitting for 3 hours and driven for less than 1 mile (1.6 km) in that 3 hour period. Allow the tyre to cool before measuring the inflation pressure. Always be sure the tyre is cold before inflating to the recommended pressure.

WARNING

TPMS

- The TPMS cannot alert you to severe and sudden tyre damage caused by external factors such as nails or road debris.
- If you feel any vehicle instability, immediately take your foot off the accelerator, apply the brakes gradually and with light force, and slowly move to a safe position off the road.

WARNING

Protecting TPMS

Tampering with, modifying, or disabling the Tyre Pressure Monitoring System (TPMS) components may interfere with the system's ability to warn the driver of low tyre pressure conditions and/or TPMS malfunctions. Tampering with, modifying, or disabling the Tyre Pressure Monitoring System (TPMS) components may void the warranty for that portion of the vehicle.

⚠ WARNING

For EUROPE

- Do not modify the vehicle, it may interfere with the TPMS function.
- The wheels on the market do not have a TPMS sensor. For your safety, use parts for replacement from a professional workshop. Kia recommends to visit an authorised Kia dealer/service partner.
- If you use the wheels on the market, use a TPMS sensor approved by an authorised Kia dealer.

If your vehicle is not equipped with a TPMS sensor or TPMS does not work properly, you may fail the periodic vehicle inspection conducted in your country.

- All vehicles sold in the EUROPE market during below period must be equipped with TPMS.
- New model vehicle: Nov. 1, 2012 ~
- Current model vehicle: Nov. 1, 2014~ (Based on vehicle registrations)

⚠ CAUTION

We recommend that you use the sealant approved by Kia if your vehicle is equipped with a Tyre Pressure Monitoring System. The liquid sealant can damage the tyre pressure sensors.

If you have a flat tyre (with spare tyre)

Jack and tools



- 1 Jack
- 2 Wheel lug nut wrench

Removing and storing the spare tyre

Operation

1. Remove the luggage board cover.



2. Turn the tyre hold-down wing bolt counterclockwise. If it is hard to loosen the tyre holddown wing bolt by hand, you can loosen it easily using the wheel lug nut wrench.



3. Store the tyre in the reverse order of removal. To prevent the spare tyre and tools from "rattling" whilst the vehicle is in motion, store them properly.

WARNING

- Be cautious as the minimum ground clearance gets lower when you store the original tyre in the bottom of the vehicle after replacing it with a spare tyre. In particular, drive below 30 km/h (18 mph) when driving over a speed bump and on uphill/downhill/uneven road.
- Never attempt vehicle repairs in the traffic lanes of a public road or highway.
- Always move the vehicle completely off the road and onto the shoulder before trying to change a tyre. The jack should be used on firm level ground. If you cannot find a firm level place off the road, call a towing service company for assistance.
- Be sure to use the correct front and rear jacking positions on the vehicle; never use the bumpers or any other part of the vehicle for jacking support.
- The vehicle can easily roll off the jack causing serious injury or death.
- Do not get under a vehicle that is supported by a jack.
- Do not start or run the engine whilst the vehicle is on the jack.
- Do not allow anyone remain in the vehicle whilst it is on the jack.
- Make sure any children present are in a secure place away from the road and from the vehicle to be raised with the jack.
- Ensure the spare tyre retainer is properly aligned with the centre of the spare tyre to prevent the spare tyre from "rattling". Otherwise, it may cause the spare tyre to fall off the carrier and lead to an accident.

Changing tyres

Operation

1. Stop the vehicle to a safe leveled place away from traffic.



2. Turn the hazard warning flasher on.
3. Set the parking brake.
4. Change the gear to P and turn the vehicle off.
5. Remove the jack, wheel lug nut wrench and the spare tyre from the vehicle.
6. Block both the front and rear of wheel that is diagonally opposite the jack position.



7. Loosen the wheel lug nuts counter-clockwise one turn each. Do not remove any wheel lug nuts until the tyre has been raised off the ground.



8. Place the jack at the front (1) or rear (2) designated jacking positions.



9. Insert the jack handle into the jack and turn it clockwise. Raise the vehicle until the tyre just clears the ground. Make sure the vehicle is stable before removing the wheel lug nuts.



- 10. Loosen the wheel nuts and remove them by hand.
- 11. Slide the wheel off the studs and lay it flat so it does not roll away.
- 12. Pick up the spare tyre, line up the holes with the studs and slide the wheel onto them. Tip the wheel slightly and get the top hole in the wheel lined up with the top stud. Jiggle the wheel back and forth until the wheel slides over the other studs.
- 13. Hold it on the studs, put the wheel nuts on the studs and tighten them by hand. Jiggle the tyre to make sure it is completely seated.
- 14. Lower the vehicle to the ground by turning the wheel lug nut wrench counterclockwise.

15. Position the wheel lug nut wrench and tighten the wheel nuts. Be sure the socket is seated completely over the nut. Go around the wheel tightening every other nut until they are all tight. Double-check each nut for tightness.



After changing tyres, have your vehicle checked by a professional workshop or seek other qualified assistance. Kia recommends to call an authorised Kia dealer/service partner.

⚠ WARNING

- To prevent vehicle movement whilst changing a tyre, always set the parking brake fully, and always block the wheel diagonally opposite the wheel being changed.
- We recommend that the wheels of the vehicle be chocked, and that no person remain in a vehicle that is being jacked.
- To reduce the possibility of injury, be sure to use only the jack provided with the vehicle and in the correct jack position; never use any other part of the vehicle for jack support.
- Wheels may have sharp edges. Handle them carefully to avoid possible severe injury. Before putting the wheel into place, be sure that there is nothing on the hub or wheel (such as mud, tar, gravel, etc.) that interferes with the wheel from fitting solidly against the hub. If there is, remove it. If there is not good contact on the mounting surface between the wheel

and hub, the wheel nuts could come loose and cause the loss of a wheel. Loss of a wheel may result in loss of control of the vehicle. This may cause serious injury or death.

Wheel lug nut tightening torque

- 11~13 kgf·m (79~94 lbf·ft)

* INFORMATION

If the pressure is lower than recommended, drive slowly to the nearest service station and inflate to the correct pressure. If it is too high, adjust it until it is correct.

▲ CAUTION

Your vehicle has metric threads on the wheel studs and nuts. Make certain during wheel removal that the same nuts that were removed are reinstalled - or, if replaced, that nuts with metric threads and the same chamfer configuration are used. Installation of a non-metric thread nut on a metric stud or vice-versa will not secure the wheel to the hub properly and will damage the stud so that it must be replaced.

Note that most lug nuts do not have metric threads. Be sure to use extreme care in checking for thread style before installing aftermarket lug nuts or wheels. If in doubt, consult a professional workshop. Kia recommends to consult an authorised Kia dealer/service partner.

▲ WARNING

- If the studs are damaged, they may lose their ability to retain the wheel. This could lead to the loss of the wheel and a collision resulting in serious injuries.

- Check the inflation pressures as soon as possible after installing the spare tyre. Adjust it to the specified pressure, if necessary. Refer to "Tyres and wheels" on page 9-49.

Important - use of compact spare tyre

The compact spare tyre is smaller than a conventional tyre and is designed for temporary use only.

Precautions

- Do not exceed 80 km/h (50 mph).
- Drive slowly enough to avoid all hazards.
- Continuous road use could result in tyre failure, loss of vehicle control, and possible personal injury.
- Do not exceed the vehicle's maximum load rating or the load carrying capacity.
- Avoid driving over obstacles.
- Do not take the vehicle through an automatic car wash.
- Do not use tyre chains on the temporary compact tyre.
- Do not install on the front axle if the vehicle must be driven in snow or on ice.
- Do not use on any other vehicle.
- Inspect your compact spare tyre regularly and replace with the same size and design.
- The compact spare tyre should not be used on any other wheels, nor should standard tyres, snow tyres, wheel covers or trim rings be used with the compact spare wheel.
- Do not use more than one compact spare tyre at a time.

- Do not tow a trailer whilst the compact spare tyre is installed.

⚠ WARNING

The compact spare tyre is for emergency use only. Do not operate your vehicle on this compact spare at the speed over 80 km/h (50 mph). The original tyre should be repaired or replaced as soon as possible to avoid failure of the spare possibly leading to personal injury or death.

⚠ CAUTION

- You should drive carefully when the compact spare is in use. The compact spare should be replaced by the proper conventional tyre and rim at the first opportunity.
 - The operation of this vehicle is not recommended with more than one compact spare tyre in use at the same time.
 - Check the inflation pressure after installing the spare tyre. Adjust it to the specified pressure, as necessary.
-

Jack label

Type A

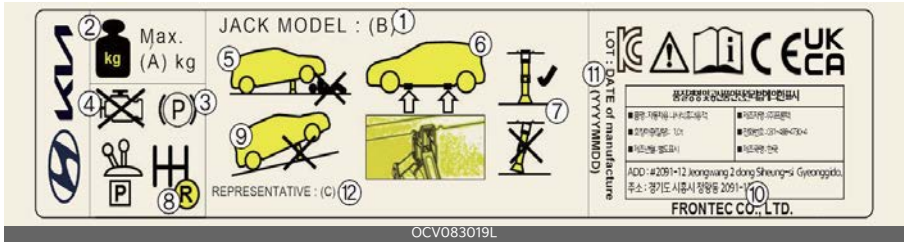

Type B

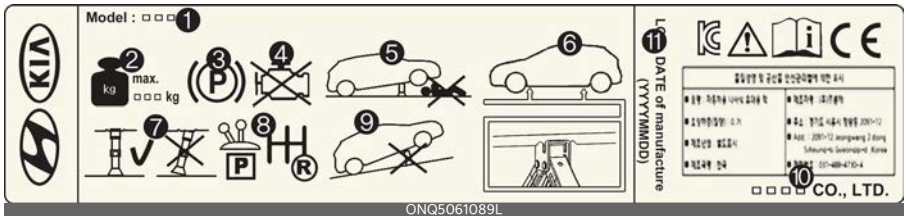

Type C



Type D



* The actual Jack label in the vehicle may differ from the illustration. For more detailed specifications, refer to the label attached to the jack.

- 1 Model Name
- 2 Maximum allowable load
- 3 When using the jack, set your parking brake.

- 4** When using the jack, stop the engine.
- 5** Do not get under a vehicle that is supported by a jack.
- 6** The designated locations under the frame
- 7** When supporting the vehicle, the base plate of jack must be vertical under the lifting point.
- 8** Shift into Reverse gear on vehicles with manual transmission or move the shift lever to the P position on vehicles with automatic transmission/dual clutch transmission.
- 9** The jack should be used on firm level ground.
- 10** Jack manufacturer
- 11** Production date
- 12** Representative company and address

Declaration of Conformity for Jack

CE



EC Declaration of Conformity
according to EC Machinery Directive 2006/42/EC

We, **FRONTEC CO., LTD.**
64 Huimanggongwon-ro, Siheung-si, Gyeonggi-do, Korea
declare under our sole responsibility that the product

Product : JACK-ASSY
Type Designation(s) : 1200KG, 1000KG, 800KG, 700KG, 500KG
Serial No. : N/A (prototype)
Year of Manufacture : 2014

to which this declaration relates is in conformity with the following standard(s) or other normative document(s);

| | |
|-----------------------|--|
| EN ISO12100 (2010) | Safety of machinery - General principles for design – Risk assessment and risk reduction |
| EN 1494/A1 (2008) | Mobile or movable jacks and associated lifting equipment |

following the provisions of Directive(s);

| | |
|------------|--|
| 2006/42/EC | Directive on the approximation of the laws of Member States relating to machinery (OJ L157 Jun. 9, 2006) |
|------------|--|



Siheung-si Gyeonggi-d ,Korea / 06.10.2022 SOO HONG, MIN President

(Place and date of issue)(Name and signature or equivalent making of authorized person)

* T.C.F Compiling Location:

- Address: PRIBORSKA 280, 739 42 FRYDEK MISTEK,CHLEBOVICE, CZECH REPUBLIC
- Team: Purchase team
- Company name: HANWHA

ONQ5E052168L

UKCA

UK Declaration Of Conformity

According to The Supply of Machinery (Safety) Regulations 2008

For the Client,

| | |
|---------------------|-------------------------------------|
| Machine description | Jack-Assy |
| Machine Type/Model | 500KG, 700KG, 800KG, 1000KG, 1200KG |
| Serial No. | - |
| Year of Manufacture | - |

Manufacturer:

FRONTEC CO., LTD.

2091-12, Jeongwang 2(i)-dong, Siheung-si, Gyeonggi-do, Korea
(64 Huimangongwon-ro, Siheung-si, Gyeonggi-do, Korea)

We declare that the **above equipment complies with the Annex I: Essential health and safety requirements relating to the design and construction of machinery by applying** the below regulation and following standards.

Applied regulation

Annex I: Essential health and safety requirements relating to the design and construction of machinery of The Supply of Machinery (Safety) Regulations 2008

Applied standards

| | |
|-------------------|--|
| EN ISO 12100:2010 | Safety of machinery – General principles for design – Risk assessment and Risk reduction |
| EN 1494/A1(2008) | Safety of machinery – Electrical equipment for machines – Part 1: General requirements |

***TCF Compiling**

N.A

location

| | |
|--|-----|
| The notified body which carried out the EC type-examination or quality assurance system approval | N/A |
| Name, Address | - |
| Identification No. | - |

Manufacturer

Name: SooHong, Min
 Position: President
 Signature: 

Authorized representative in the Community

Name: N/A
 Address: N/A
 Signature: _____

ONQ5E052169L

Towing

Towing service

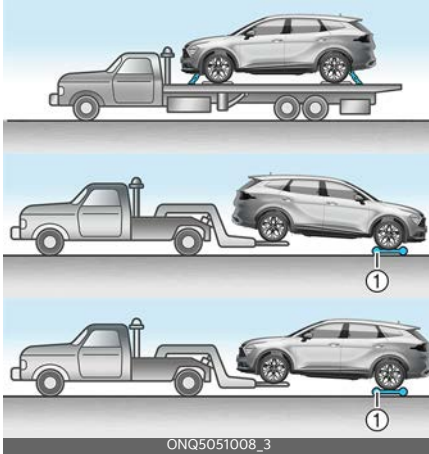

1 Wheel dolly

- Proper lifting and towing procedures are necessary to prevent damage to the vehicle. The use of wheel dolly (1) or flatbed is recommended.
- On 2WD vehicles, it is acceptable to tow the vehicle with the rear wheels on the ground (without dollies) and the front wheels off the ground.

* INFORMATION

If emergency towing is necessary, we recommend having it done by an authorised Kia dealer or a commercial tow-truck service.

⚠ CAUTION

The AWD vehicle should never be towed with the wheels on the ground. This can cause serious damage to the transmission or the AWD system.

Towing All-Wheel Drive vehicle



Operation

1. Open the tailgate, and remove the towing hook from the tool case.
2. Tow the vehicle with a wheel lift and dollies or flatbed equipment with all wheels off the ground.

⚠ CAUTION

- Do not tow the vehicle backwards with the front wheels on the ground as this may cause damage to the vehicle.
- Do not tow with sling-type equipment. Use wheel lift or flatbed equipment.

Towing without wheel dolly

Operation

1. Set the vehicle to ACC (Accessory).
2. Change the gear to N.
3. Release the parking brake.

⚠ CAUTION

Failure to shift the gear to N (Neutral) may cause internal damage to the transmission.

Emergency towing

Front



Rear



Operation

1. Remove the hole cover pressing the lower part of the cover on the bumper.
2. Install the towing hook by turning it clockwise into the hole until it is fully secured.
3. Remove the towing hook and install the cover after use.

* INFORMATION

Towing in this manner may be done only on hard-surfaced roads for a short distance and at low speed. Also, the wheels, axles, power train, steering and brakes must all be in good condition.

- If towing is necessary, we recommend you to have it done by an authorised Kia dealer or a commercial tow truck service. If towing service is not available in an emergency, your vehicle may be temporarily towed using a cable or chain secured to the emergency towing hook under the front (or rear) of the vehicle. Use extreme cau-

tion when towing the vehicle. A driver must be in the vehicle to steer it and operate the brakes.

- Do not use the tow hooks to pull a vehicle out of mud, sand or other conditions from which the vehicle cannot be driven out under its own power.
- Avoid towing a vehicle heavier than the vehicle doing the towing.
- The drivers of both vehicles should communicate with each other frequently.
- Before emergency towing, check if the hook is not broken or damaged.
- Fasten the towing cable or chain securely to the hook.
- Do not jerk the hook. Apply it steadily and with even force.
- To avoid damaging the hook, do not pull from the side or at a vertical angle. Always pull straight ahead.
- Turn the ignition switch or the ENGINE START/STOP button to the ACC position so the steering wheel is not locked.
- Change the gear to N (Neutral).
- Release the parking brake.
- The vehicle should be towed at a speed of 25 km/h (15 mph) or less within the distance of 20 km (12 miles). (for Manual transmission vehicle)
- To avoid serious damage to the automatic transmission / dual clutch transmission, limit the vehicle speed to 15 km/h (10 mph) and drive less than 1.5 km (1 mile) when towing. (for automatic transmission and dual clutch transmission)
- Press the brake pedal with more force than normal since you will have reduced brake performance.

- More steering effort will be required because the power steering system will be disabled.
- If you are driving down a long hill, the brakes may overheat and brake performance will be reduced. Stop often and let the brakes cool off.
- The driver must be in the vehicle for steering and braking operations when the vehicle is towed and passengers other than the driver must not be allowed to be on board.

WARNING

Use extreme caution when towing the vehicle.

- Avoid sudden starts or erratic driving manoeuvres which would place excessive stress on the emergency towing hook and towing cable or chain. The hook and towing cable or chain may break and cause serious injury or damage.
- If the disabled vehicle is unable to be moved, do not forcibly continue the towing. We recommend that you contact an authorised Kia dealer or a commercial tow truck service for assistance.
- Tow the vehicle as straight ahead as possible.
- Keep away from the vehicle during towing.

CAUTION

- Attach a towing strap to the tow hook.
- Using a portion of the vehicle other than the tow hooks for towing may damage the body of your vehicle.
- Use only a cable or chain specifically intended for use in towing vehicles.

Securely fasten the cable or chain to the towing hook provided.

- Accelerate or decelerate the vehicle in a slow and gradual manner whilst maintaining tension on the tow rope or chain to start or drive the vehicle, otherwise tow hooks and the vehicle may be damaged.
- If the car is being towed with all four wheels on the ground, it can be towed only from the front. Be sure that the transmission is in neutral. Be sure the steering is unlocked by placing the ignition switch in the ACC position. A driver must be in the towed vehicle to operate the steering and brakes.
- The vehicle should be towed at a speed of 25 km/h (15 mph) or less within the distance of 20 km (12 miles). (for Manual transmission vehicle)
- Before towing, check the automatic transmission / dual clutch transmission for fluid leaks under your vehicle. If the automatic transmission / dual clutch transmission fluid is leaking, flatbed equipment or a towing dolly must be used.

Emergency commodity (if equipped)

There are some emergency commodities in the vehicle to help you respond to the emergency situation.

Fire extinguisher

1. Pull the pin at the top of the extinguisher.
2. Aim the nozzle toward the base of the fire.
3. Stand approximately 2.5 m (8 ft) away from the fire and squeeze the handle to discharge the extinguisher.
4. Sweep the nozzle back and forth at the base of the fire. After the fire appears to be out, watch it carefully since it may re-ignite.

First aid kit

Scissors, bandage and adhesive tape and etc. in the kit is provided.

Triangle reflector

Place the triangle reflector on the road to warn oncoming vehicles.

Tyre pressure gauge

1. Unscrew the inflation valve cap.
2. Press and hold the gauge against the tyre valve.
3. A firm non-leaking push will activate the gauge.
 - Read the tyre pressure on the gauge to know whether the tyre pressure is low or high.
4. Adjust the tyre pressures to the specified pressure.
5. Reinstall the inflation valve cap.

ERA-GLONASS emergency call (if equipped)

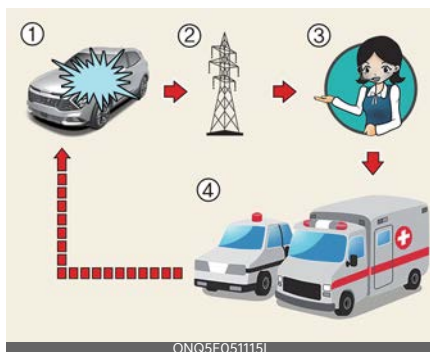

- 1 Road accident
- 2 Wireless network
- 3 Single duty dispatch service (SDDS)
- 4 Rescue

The car is equipped with a device¹ connected with the system ERA-GLONASS for making emergency call to response teams. The system ERA-GLONASS is an automatic emergency call service made in event of a traffic accident or other² accidents on the roads of Russian Federation. The system allows contacting with an officer of the single duty dispatch service in case of accidents on the roads of Russian Federation.

The system ERA-GLONASS given conditions, stated in the Owner's Manual as well as Warranty and Service book transmits data to the single duty dispatch service, including such information as vehicle location, vehicle type, VIN (vehicle identification number of the car).

Once the data which stored in the ERA-GLONASS system is delivered to the rescue centre to assist the driver and passengers with proper rescue operations, the data will be deleted after rescue operation is completed.

Operator of the system ERA-GLONASS (stock company "GLONASS") is responsible for all components of the system ERA-GLONASS (excluding equipment, installed in the car) in accordance with the federal law "On state automated information system ERA-GLONASS" # 395-FZ from 28.12.2013.

1. * ERA-GLONASS device in the Owner's Manual means equipment, installed in the car, which provides connection with the ERA-GLONASS system.
2. * "Other accidents" mean any accidents on the roads of Russian Federation resulted in injured people and/or necessity of provision of assistance. In case of registration of any accident, it is necessary to stop a vehicle, press button SOS (location of the button is specified on the picture in the chapter "ERA-GLONASS EMERGENCY CALL (IF EQUIPPED)") of the Owner's Manual. When making a call, the system gathers information about the car (from which a call was made), after which connects the car with an officer of the single duty dispatch service to tell about the reason of the emergency call.

ERA-GLONASS system



- 1 Microphone
- 2 SOS button
- 3 SOS TEST button
- 4 LED

SOS button: the driver/passenger makes an emergency call to the single duty dispatch service by pressing the button.

SOS TEST button (test): the button is to check working ability of the system in the official dealership of Kia. The mode "SOS TEST" can be activated strictly by the specialist of the authorised dealer/service partner of Kia. To avoid erroneous calls, please, do not press this button and do not activate the mode "SOS TEST" by yourself.

LED: The red and green LED illuminates for 3 seconds when the ignition switch is in the ON position. After that they will switch off at normal operation of the system.

If there are some problems in the system, the LED remains in red.

Automatic accident reporting

1. System operation in the event of a traffic accident



2. Connection with the single duty dispatch service



3. Emergency services



The ERA-GLONASS device automatically makes an emergency call to the single duty dispatch service for proper rescuing operations in event of car accident. For proper emergency services and support the ERA-GLONASS system automatically transmits the accident data to the single duty dispatch service when a traffic accident is detected.

In this case, the emergency call cannot be hung up by pressing the SOS button and the ERA-GLONASS system remains connected until the emergency service officer, receiving the call, disconnects the emergency call.

* NOTICE

In even of minor traffic accidents the ERA-GLONASS system may not execute an emergency call. However, an emergency call may be made manually by pressing the SOS button.

⚠ CAUTION

Operation of the system is impossible in case of absence of mobile transmission and GPS and GLONASS signals.

Manual accident reporting

1. Pressing the SOS button



2. Connection with the single duty dispatch service



3. Emergency services



Driver or passenger manually can make an emergency call in the single duty dispatch service, by pressing SOS button to call the necessary emergency services.

A call to the emergency services through the ERA-GLONASS system can be cancelled by pressing the SOS button again only before the call connection.

After activation of emergency call in the manual mode (for proper emergency services and support), the ERA-GLONASS system automatically transmits the road accident data/or data on other accident to the officer of the single duty dispatch service (during emergency call) by pressing the SOS button.

In case of road accident or other accident for activation of emergency call in manual mode it is necessary:

1. Stop a car, after which in accordance with traffic rules to ensure safety to yourself and other participants of road traffic;
2. Press the SOS button, when pressing the button SOS registration of the device in the wireless telephonic communication networks is carried out, minimum data set about car and its location is collected in accordance with of the technical requirements of the device. After that connection with the officer of the ERA-GLONASS system is made for clearing up reasons (conditions) of the emergency call.
3. After clearing up reasons of the emergency call, the officer of the single duty dispatch service sends minimum data set to emergency services and completes the emergency call.

If the emergency call is not carried out in accordance with the procedure, mentioned above, the emergency call will be considered as erroneous.

⚠ WARNING

Emergency power supply of the system ERA-GLONASS from the battery

- The ERA-GLONASS system battery supplies power during 1 hour in case main power source of the vehicle is cut off due to the collision during the emergency situations.
- The ERA-GLONASS system battery should be replaced every 4 years. For more information refer to "Scheduled maintenance service" on page 9-9.

LED illumination in red (system malfunction)

If red LED illuminates in normal driving conditions, this can indicate malfunction of the ERA-GLONASS system. Please, have the ERA-GLONASS system

checked at an authorised Kia dealer/service partner immediately. Otherwise correct operation of the ERA-GLONASS system device, installed in your car is not guaranteed. Owner of the car incurs liability for consequences, occurred as a result of nonobservance of conditions, mentioned above.

Arbitrary Removal or Modification

The ERA-GLONASS system calls emergency services for assistance. Thus, any arbitrary removal or changes to the ERA-GLONASS system settings may affect your driving safety. Also, it may even make an erroneous emergency call to the single duty dispatch service. Thereby, we kindly ask you not to make any changes by yourself or by the third parties in the settings of the equipment of the ERA-GLONASS system, installed in your car.

Test Mode



Elements of the system ERA-GLONASS, installed in passenger compartment:

- 1 Microphone
- 2 SOS button
- 3 SOS TEST button
- 4 LED

There is a technical opportunity to check working ability of the ERA-GLONASS device, installed in your car. In order to avoid making erroneous calls and incorrect operation of the device, checking of the ERA-GLONASS device, installed in your car, should be carried out only by specialists of authorised Kia dealer/service partner and on their territory in accordance with the following manual (on applying user interface for launching test mode).

You can start the ERA-GLONASS test mode by pressing the SOS TEST button. The test mode starts with a voice guidance to check working ability of the ERA-GLONASS device. In the course of checking working ability of the ERA-GLONASS device red and green LED illuminate.

Re-press the SOS TEST button again to deactivate the test mode during the voice guidance.

| | |
|--|-------------|
| Engine compartment | 9-5 |
| Maintenance services | 9-7 |
| • Owner's responsibility..... | 9-7 |
| • Owner maintenance precautions..... | 9-7 |
| Owner maintenance | 9-8 |
| • Owner maintenance schedule..... | 9-8 |
| Scheduled maintenance service | 9-9 |
| Scheduled maintenance service | 9-17 |
| Explanation of scheduled maintenance items | 9-32 |
| • Engine oil and filter..... | 9-32 |
| • Drive belts..... | 9-32 |
| • Fuel filter cartridge (for diesel engine)..... | 9-32 |
| • Fuel filter (for petrol engine)..... | 9-32 |
| • Fuel lines, fuel hoses and connections..... | 9-32 |
| • Vapour hose and fuel filler cap (for petrol engine)..... | 9-32 |
| • Vacuum crankcase ventilation hoses..... | 9-33 |
| • Air cleaner filter..... | 9-33 |
| • Spark plugs (for petrol engine)..... | 9-33 |
| • Cooling system..... | 9-33 |
| • Coolant..... | 9-33 |
| • Dual clutch transmission (DCT) fluid..... | 9-33 |
| • Automatic transmission (AT) fluid..... | 9-33 |
| • Brake hoses and lines..... | 9-34 |
| • Brake/clutch fluid..... | 9-34 |
| • Parking brake..... | 9-34 |
| • Brake discs, pads and calipers..... | 9-34 |
| • Suspension mounting bolts..... | 9-34 |
| • Steering gear box, linkage & boots/lower arm ball joint..... | 9-34 |
| • Drive shafts and boots..... | 9-34 |
| • Air conditioning refrigerant..... | 9-34 |
| • Propeller shaft..... | 9-34 |

9 Maintenance

| | |
|--|-------------|
| • Checking fluid levels..... | 9-34 |
| Engine oil | 9-35 |
| • Checking engine oil level..... | 9-35 |
| • Replenishing engine oil | 9-36 |
| • Changing engine oil and filter..... | 9-36 |
| Engine coolant | 9-38 |
| • Checking coolant level..... | 9-38 |
| • Changing coolant..... | 9-39 |
| Brake/clutch fluid | 9-40 |
| • Checking brake/clutch fluid level | 9-40 |
| Washer fluid | 9-41 |
| • Checking washer fluid level | 9-41 |
| Parking brake..... | 9-41 |
| • Checking the parking brake (Hand type) | 9-41 |
| • Checking the parking brake (Foot type) | 9-42 |
| Fuel filter (Diesel) | 9-42 |
| • Draining water from fuel filter..... | 9-42 |
| • Replacing fuel filter cartridge..... | 9-42 |
| Air cleaner filter | 9-43 |
| • Replacing air cleaner filter | 9-43 |
| Climate control air filter..... | 9-44 |
| • Replacing climate control air filter | 9-44 |
| Wiper blades..... | 9-45 |
| • Replacing front wiper blade..... | 9-45 |
| • Replacing rear wiper blade..... | 9-45 |
| Battery..... | 9-47 |
| • For best battery service | 9-47 |
| • Battery capacity label | 9-48 |
| • Battery recharging | 9-48 |
| • Reset items | 9-49 |

| | |
|---|-------------|
| Tyres and wheels | 9-49 |
| • Tyre care..... | 9-49 |
| • Recommended cold tyre inflation pressures..... | 9-49 |
| • Checking tyre inflation pressure..... | 9-49 |
| • Tyre rotation..... | 9-51 |
| • Wheel alignment and tyre balance..... | 9-51 |
| • Tyre replacement..... | 9-51 |
| • Wheel replacement..... | 9-52 |
| • Tyre traction..... | 9-53 |
| • Tyre maintenance..... | 9-53 |
| • Tyre sidewall labeling..... | 9-53 |
| • Low aspect ratio tyre..... | 9-55 |
| Fuses | 9-56 |
| • Replacing inner panel fuse..... | 9-58 |
| • Replacing engine compartment fuse..... | 9-58 |
| • Fuse/relay panel description..... | 9-59 |
| Light bulbs | 9-70 |
| • Bulb replacement precautions..... | 9-70 |
| • Light position (Front)..... | 9-71 |
| • Light position (Rear)..... | 9-72 |
| • Light position (Side)..... | 9-72 |
| • Replacing lights (LED type)..... | 9-72 |
| • Replacing front turn signal lamp (Bulb type)..... | 9-72 |
| • Replacing front fog lamp (Bulb type)..... | 9-73 |
| • Replacing rear turn signal lamp, stop lamp (Bulb type)..... | 9-73 |
| • Replacing rear fog lamp (Bulb type)..... | 9-74 |
| • Replacing license plate lamp (Bulb type)..... | 9-74 |
| • Replacing map lamp (Bulb type)..... | 9-74 |
| • Replacing room lamp (Bulb type)..... | 9-75 |
| • Replacing vanity mirror lamp (Bulb type)..... | 9-75 |
| • Replacing glove box lamp (Bulb type)..... | 9-75 |
| • Replacing luggage lamp (Bulb type)..... | 9-76 |

9 Maintenance

| | |
|---|-------------|
| • Headlamp and front fog lamp aiming (for Europe) | 9-76 |
| Appearance care | 9-81 |
| • Exterior care | 9-81 |
| • Interior care | 9-85 |
| Emission control system | 9-87 |
| • Lean NOx Trap..... | 9-90 |
| • Selective Catalytic Reduction | 9-90 |

Maintenance

Engine compartment

Smartstream G2.5 GDi



ONQ5061001R

Smartstream G1.6 T-GDi



ONQ5061087R

Smartstream G2.0



Smartstream D2.0



* The actual features in your vehicle may not necessarily be available due to the selected options or regions.

- 1 Engine coolant reservoir
- 2 Brake fluid reservoir
- 3 Air cleaner
- 4 Engine oil filler cap
- 5 Engine oil dipstick
- 6 Windscreen washer fluid reservoir
- 7 Positive battery terminal (+)
- 8 Negative battery terminal (-)
- 9 Fuse box

Maintenance services

Owner's responsibility

- Have your vehicle serviced by a professional workshop. Kia recommends to visit an authorised Kia dealer/service partner.
- Retain documents that show proper maintenance.
- Establish your compliance with the servicing and maintenance requirements of your vehicle warranties.
- Repairs and adjustments required as a result of improper maintenance or a lack of required maintenance are not covered when your vehicle is covered by warranty.

* NOTICE

Maintenance Service and Record Retention are the owner's responsibility.

Owner maintenance precautions

Improper or incomplete service may result in problems. This section gives instructions only for the maintenance items that are easy to perform.

Diesel engine compartment precautions

- The piezo injector operates at high voltage (maximum 200V).
- Do not touch the injector, injector wirings, and the engine computer whilst the engine is running.
- Do not remove the injector connector whilst the engine is running.
- People using pacemakers must not go near the engine whilst the engine is starting or running.

⚠ WARNING

- Performing maintenance work on a vehicle can be dangerous. You can be seriously injured whilst performing some maintenance procedures. If you lack sufficient knowledge and experience or the proper tools and equipment to do the work, have the system serviced by a professional workshop. Kia recommends to visit an authorised Kia dealer/service partner.
- Working under the bonnet with the engine running is dangerous. It becomes even more dangerous when you wear jewelry or loose clothing. These can become entangled in moving parts and result in injury. Therefore, if you must run the engine whilst working under the bonnet, make certain that you remove all jewelry (especially rings, bracelets, watches, and necklaces) and all neckties, scarves, and similar loose clothing before getting near the engine or cooling fans.
- Never work on the injection system with the engine running or within 30 seconds after shutting off the engine. High-pressure pump, rail, injectors and high-pressure pipes are subject to high pressure even after the engine stopped. The fuel jet produced by fuel leaks may cause serious injury, if it touches the body. People using pacemakers should not move more than 30cm closer to the ECU or wiring harness within the engine room whilst the engine is running, since the high currents in the electronic engine control system produce considerable magnetic fields.

⚠ CAUTION

- Do not put heavy objects or apply excessive force on top of the engine cover (if equipped) or fuel related parts.
- When you inspect the fuel system (fuel lines and fuel injection devices), contact a professional workshop. Kia recommends to visit an authorised Kia dealer/service partner.
- Do not drive long time with the engine cover removed.
- When checking the engine room, do not go near fire. Fuel, washer fluid, etc. are flammable oils that may cause fire.
- Before touching the battery, ignition cables and electrical wiring, you should disconnect the battery "-" terminal. You may get an electric shock from the electric current.
- When you remove the interior trim cover with a flat bed (-) driver, be careful not to damage the cover.
- Be careful when you replace and clean bulbs to avoid burns or electrical shock.

*** NOTICE**

Improper owner maintenance during the warranty period may affect warranty coverage. For details, read the separate Warranty & Maintenance book provided with the vehicle. If you're unsure about any servicing or maintenance procedure, have the system serviced by a professional workshop. Kia recommends to visit an authorised Kia dealer/service partner.

Owner maintenance**Owner maintenance schedule****When you stop for fuel**

- Check the coolant level in the coolant reservoir.
- Check the windscreen washer fluid level.
- Look for low or under-inflated tyres.

⚠ WARNING

Be careful when checking your engine coolant level when the engine is hot. Scalding hot coolant and steam may blow out under pressure. This could cause burns or other serious injury.

Whilst operating your vehicle

- Note any changes in the sound of the exhaust or any smell of exhaust fumes in the vehicle.
- Check for vibrations in the steering wheel. Notice any increased steering effort or looseness in the steering wheel, or change in its straightahead position.
- Notice if your vehicle constantly turns slightly or "pulls" to one side when travelling on smooth, level road.
- When stopping, listen and check for unusual sounds, pulling to one side, increased brake pedal travel or "hard-to-push" brake pedal.
- If any slipping or changes in the operation of your transmission occurs, check the transmission fluid level.
- Check the parking brake.
- Check for fluid leaks under your vehicle (water dripping from the air conditioning system during or after use is normal).

At least monthly

- Check the coolant level in the engine coolant reservoir.
- Check the operation of all exterior lights, including the stoplights, turn signals and hazard warning flashers.
- Check the inflation pressures of all tyres including the spare for tyres that are worn, show uneven wear, or are damaged.
- Check for loose wheel lug nuts.

At least twice a year

- Check the radiator, heater and air conditioning hoses for leaks or damage.
- Check the windscreen washer spray and wiper operation. Clean the wiper blades with clean cloth dampened with washer fluid.
- Check the headlight alignment.
- Check the muffler, exhaust pipes, shields and clamps.
- Check the lap/shoulder belts for wear and function.

At least once a year

- Clean the body and door drain holes.
- Lubricate the door hinges and checks, and bonnet hinges.
- Lubricate the door and bonnet locks and latches.
- Lubricate the door rubber weatherstrips.
- Check the air conditioning system.
- Inspect and lubricate the automatic transmission linkage and controls.
- Clean the battery and terminals.
- Check the brake fluid level.

Scheduled maintenance service

If your vehicle is operated in any of the severe driving conditions, you should inspect, replace or refill more frequently, using the severe usage maintenance schedule instead of the normal usage maintenance schedule.

Normal maintenance schedule - except Europe (Including Russia)

The following maintenance services must be performed to ensure good emission control and performance. Keep receipts for all vehicle emission services to protect your warranty. Where both mileage and time are shown, the frequency of service is determined by whichever occurs first.

| NO. | Item | Remark |
|-----|---|---|
| 1 | Engine oil and engine oil filter | <ul style="list-style-type: none"> As it is normal for engine oil to be consumed during driving, the engine oil level should be checked on regular basis. The engine oil change interval for normal operating conditions is based on the use of the recommended engine specification. If the recommended engine oil specification is not used, then replace the engine oil according to the maintenance schedule under severe operating conditions. Never add any additives to the engine oil. Engine oil additives can change the properties of engine oil and may cause serious engine failure. |
| 2 | Engine oil and engine oil filter (Diesel) | <ul style="list-style-type: none"> The engine oil level should be checked regularly and maintained properly. Operating with an insufficient amount oil can damage the engine, and such damage is not covered by warranty. This maintenance schedule depends on fuel quality. It is applicable only when using a qualified fuel <"EN590 or equivalent">. If the diesel fuel specifications don't meet the EN590, it must be replaced according to the severe maintenance schedule. Never add any additives to the engine oil. Engine oil additives can change the properties of engine oil and may cause serious engine failure. |
| 3 | Coolant (Engine) | When adding coolant, use only deionized water or soft water for your vehicle and never mix hard water in the coolant filled at the factory. An improper coolant mixture can result in serious malfunction or engine damage. |
| 4 | Drive belts (Engine) | <ul style="list-style-type: none"> Adjust alternator, water pump and air conditioner drive belt. Inspect and if necessary repair or replace. Inspect drive belt tensioner, idler and alternator pulley and if necessary correct or replace. |
| 5 | Spark plug | For your convenience, it can be replaced prior to it's interval when you do maintenance of other items. |
| 6 | Rear differential oil (AWD) | Differential oil should be changed anytime it has been submerged in water. |
| 7 | Transfer case oil (AWD) | Transfer case oil should be changed anytime it has been submerged in water. |
| 8 | Fuel additives | <p>Kia recommends that you use unleaded petrol which has an octane rating of RON (Research Octane Number) 95 / AKI (Anti Knock Index) 91 or higher (for Europe) or Octane Rating of RON (Research Octane Number) 91 / AKI (Anti-Knock Index) 87 or higher (except Europe).</p> <p>For customers who do not use good quality petrols including fuel additives regularly, and have problems starting or the engine does not run smoothly, one bottle of additives should be added to the fuel tank when the engine oil is replaced. Additives are available from a professional workshop along with information on how to use them. Kia recommends to visit an authorised Kia dealer/service partner. Do not mix other additives.</p> |
| 9 | Fuel filter cartridge (Diesel) | This maintenance schedule depends on fuel quality. It is applicable only when using a qualified fuel <"EN590 or equivalent">. If the diesel fuel specifications don't meet the EN590, it must be replaced more frequently. Kia recommend "every 7,500 km (5,000 miles) inspection, every 15,000 km (10,000 miles) replacement". If there are some important safety matters like fuel flow restriction, surging, loss of power, hard starting problem etc, replace the fuel filter immediately regardless of maintenance schedule and consult a professional workshop. Kia recommends to consult an authorised Kia dealer/service partner. |
| * | Transmission fluid | Transmission fluid should be changed anytime it has been submerged in water. |

I: Inspect and adjust, correct, clean, or replace if necessary.

R: Replace or change.

| Normal Maintenance Schedule | | | | | | | | | | | |
|---|----------------------|---|---|--|----|----|----|-----|-----|---|---|
| Number of months or driving distance, whichever comes first | | | | | | | | | | | |
| Months | | 12 | 24 | 36 | 48 | 60 | 72 | 84 | 96 | | |
| Miles× 1,000 | | 10 | 20 | 30 | 40 | 50 | 60 | 70 | 80 | | |
| Km× 1,000 | | 15 | 30 | 45 | 60 | 75 | 90 | 105 | 120 | | |
| Engine oil and engine oil filter ¹² | Petrol | Smartstream G1.6 T-GDI | Except Mexico, China | Replace every 10,000 km (6,500 miles) or 12 months | | | | | | | |
| | | | For Mexico | Replace every 10,000 km (6,500 miles) or 6 months | | | | | | | |
| | | | For China | Replace every 5,000 km (3,000 miles) or 6 months | | | | | | | |
| | | Smartstream G2.0 | Except Middle East, Iran, Morocco, Algeria, Tunisia, Libya, Egypt, Sudan, India, Central & South America, Brazil, Mexico, China | R | R | R | R | R | R | R | R |
| | | | For Middle East, Iran, Morocco, Algeria, Tunisia, Libya, Egypt, Sudan, India, Central & South America, Brazil | Replace every 10,000 km (6,500 miles) or 12 months | | | | | | | |
| | | | For Mexico | Replace every 10,000 km (6,500 miles) or 6 months | | | | | | | |
| | Smartstream G2.5 GDI | Except Middle East, Iran, Morocco, Algeria, Tunisia, Libya, Egypt, Sudan, India, Central & South America, Brazil, Mexico, China | R | R | R | R | R | R | R | R | |
| | | | For Middle East, Iran, Morocco, Algeria, Tunisia, Libya, Egypt, Sudan, India, Central & South America, Brazil | Replace every 10,000 km (6,500 miles) or 12 months | | | | | | | |
| | | | For Mexico | Replace every 10,000 km (6,500 miles) or 6 months | | | | | | | |
| | Smartstream D2.0 | For Russia, Australia, New Zealand and Republic of South Africa | R | R | R | R | R | R | R | R | |
| | | | Except Russia, Australia, New Zealand and Republic of South Africa | Replace every 10,000 km (6,500 miles) or 12 months | | | | | | | |
| | | | For China | Replace every 5,000 km (3,000 miles) or 6 months | | | | | | | |
| Coolant (Engine) ³ | Petrol, Diesel | | At first, replace 210,000 km (140,000 miles) or 120 months After that, replace every 30,000 km (20,000 miles) or 24 months | | | | | | | | |
| Drive belts (Engine) ⁴ | Petrol | | - | I | - | I | - | I | - | I | |
| | Diesel | For Russia, Australia, New Zealand and Republic of South Africa | At first, inspect 90,000 km (60,000 miles) or 48 months After that, inspect every 30,000 km (20,000 miles) or 24 months | | | | | | | | |
| | | Except Russia, Australia, New Zealand and Republic of South Africa | At first, inspect 80,000 km (52,000 miles) or 48 months After that, inspect every 20,000 km (13,000 miles) or 12 months | | | | | | | | |

| Normal Maintenance Schedule | | | | | | | | | | | |
|---|--|------------------------|---|---|----|----|----|----|----|-----|-----|
| Number of months or driving distance, whichever comes first | | | | | | | | | | | |
| Months | | | | 12 | 24 | 36 | 48 | 60 | 72 | 84 | 96 |
| Miles× 1,000 | | | | 10 | 20 | 30 | 40 | 50 | 60 | 70 | 80 |
| Km× 1,000 | | | | 15 | 30 | 45 | 60 | 75 | 90 | 105 | 120 |
| Vacuum hoses and crankcase ventilation hoses | Petrol, Diesel | | | - | | - | | - | | - | |
| Spark plugs ⁵ | Petrol | Smartstream G1.6 T-GDi | Unleaded | Replace every 70,000 km (45,500 miles) | | | | | | | |
| | | Smartstream G2.0 | Unleaded | Replace every 150,000 km (100,000 miles) | | | | | | | |
| | | Smartstream G2.5 GDi | Unleaded | Replace every 150,000 km (100,000 miles) | | | | | | | |
| Automatic transmission (AT) fluid [†] | Petrol | Smartstream G2.0 | | No check, No service required | | | | | | | |
| | | Smartstream G2.5 GDi | | | | | | | | | |
| | Diesel | Smartstream D2.0 | | | | | | | | | |
| Dual clutch transmission (DCT) fluid [†] | Petrol | Smartstream G1.6 T-GDi | | No check, No service required | | | | | | | |
| Manual transmission (MT) fluid [†] | Petrol | Smartstream G2.0 | | No check, No service required | | | | | | | |
| Drive shaft and boots | Petrol, Diesel | | | - | | - | | - | | - | |
| Propeller shaft (AWD) | Petrol, Diesel | | | - | | - | | - | | - | |
| Rear differential oil (AWD) ⁶ | Petrol, Diesel | | | - | - | - | | - | - | - | |
| Transfer case oil (AWD) ⁷ | Petrol, Diesel | | | - | - | - | | - | - | - | |
| Fuel additives ⁸ | Petrol | Smartstream G1.6 T-GDi | Except Mexico, China | Add every 10,000 km (6,500 miles) or 12 months | | | | | | | |
| | | | For Mexico | Add every 10,000 km (6,500 miles) or 6 months | | | | | | | |
| | | | For China | Add every 5,000 km (3,000 miles) or 6 months | | | | | | | |
| | | Smartstream G2.5 GDi | Except Middle East, Iran, Morocco, Algeria, Tunisia, Libya, Egypt, Sudan, India, Central & South America, Brazil, Mexico, China | Add every 15,000 km (10,000 miles) or 12 months | | | | | | | |
| | | | For Middle East, Iran, Morocco, Algeria, Tunisia, Libya, Egypt, Sudan, India, Central & South America, Brazil | Add every 10,000 km (6,500 miles) or 12 months | | | | | | | |
| | | | For Mexico | Add every 10,000 km (6,500 miles) or 6 months | | | | | | | |
| For China | Add every 5,000 km (3,000 miles) or 6 months | | | | | | | | | | |
| Fuel filter | Petrol | For China, Brazil | | - | | - | R | - | | - | R |
| Fuel lines, hoses and connections | Petrol | | | - | - | - | | - | - | - | |
| | Diesel | | | - | | - | | - | | - | |

| Normal Maintenance Schedule | | | | | | | | | | |
|---|----------------|----------------------------------|--|----|----|----|----|-----|-----|---|
| Number of months or driving distance, whichever comes first | | | | | | | | | | |
| Months | | 12 | 24 | 36 | 48 | 60 | 72 | 84 | 96 | |
| Miles× 1,000 | | 10 | 20 | 30 | 40 | 50 | 60 | 70 | 80 | |
| Km× 1,000 | | 15 | 30 | 45 | 60 | 75 | 90 | 105 | 120 | |
| Fuel tank air filter | Petrol | Except China | - | I | - | R | - | I | - | R |
| | | For China | I | I | R | I | I | R | I | I |
| | Diesel | | - | - | - | I | - | - | - | I |
| Vapour hose and fuel filler cap | Petrol | | - | - | - | I | - | - | - | I |
| Fuel filler cap | Diesel | | - | - | - | I | - | - | - | I |
| Fuel filter cartridge*10 | Diesel | | - | I | - | R | - | I | - | R |
| Air cleaner filter | Petrol, Diesel | Except India, Middle East | I | I | R | I | I | R | I | I |
| | | For India, Middle East | R | R | R | R | R | R | R | R |
| Intercooler, in/out hose, air intake-hose | Petrol | Smartstream G1.6 T-GDi | Inspect every 10,000 km (6,500 miles) or 12 months | | | | | | | |
| Exhaust system | Petrol, Diesel | | - | I | - | I | - | I | - | I |
| Cooling system | Petrol, Diesel | | - | - | - | I | - | I | - | I |
| Air conditioner compressor/refrigerant | Petrol, Diesel | | I | I | I | I | I | I | I | I |
| Climate control air filter | Petrol, Diesel | Except Australia and New Zealand | R | R | R | R | R | R | R | R |
| | | For Australia and New Zealand | I | R | I | R | I | R | I | R |
| Brake discs and pads | Petrol, Diesel | | - | I | - | I | - | I | - | I |
| Brake lines, hoses and connections | Petrol, Diesel | | - | I | - | I | - | I | - | I |
| Brake/clutch fluid | Petrol, Diesel | Except Australia and New Zealand | I | I | R | I | I | R | I | I |
| | | For Australia and New Zealand | I | R | I | R | I | R | I | R |
| Parking brake (Foot/Hand type) | Petrol, Diesel | | - | I | - | I | - | I | - | I |
| Steering gear rack, linkage and boots | Petrol, Diesel | | I | I | I | I | I | I | I | I |
| Suspension ball joints | Petrol, Diesel | | I | I | I | I | I | I | I | I |
| Tyre (pressure & tread wear) | Petrol, Diesel | | I | I | I | I | I | I | I | I |
| Battery (12V) condition | Petrol, Diesel | Except Middle East | - | I | - | I | - | I | - | I |
| | | For Middle East | Inspect every 10,000 km (6,500 miles) or 6 months | | | | | | | |
| Urea solution line & connections | Diesel | | - | I | - | I | - | I | - | I |
| Urea solution filler cap | Diesel | | - | I | - | I | - | I | - | I |

| Normal Maintenance Schedule | | | | | | | | | |
|--|--------|--|----|----|----|----|----|-----|-----|
| Number of months or driving distance, whichever comes first | | | | | | | | | |
| Months | | 12 | 24 | 36 | 48 | 60 | 72 | 84 | 96 |
| Miles× 1,000 | | 10 | 20 | 30 | 40 | 50 | 60 | 70 | 80 |
| Km× 1,000 | | 15 | 30 | 45 | 60 | 75 | 90 | 105 | 120 |
| Timing belt | Diesel | Inspect every 120,000 km (80,000 miles) | | | | | | | |
| Timing belt system (Timing belt, Water pump, Tensioner, Idler) | Diesel | Replace every 240,000 km (160,000 miles) | | | | | | | |
| ERA-GLONASS system (if equipped) | | | | | | | | | |
| ERA-GLONASS system battery (if equipped) | | Replace every 4 years | | | | | | | |

- Fuel filter (Petrol engine): The fuel filter is considered to be maintenance free but periodic inspection is recommended for this maintenance schedule depends on fuel quality.
 - If there are some important safety matters like fuel flow restriction, surging, loss of power, hard starting problem etc, replace the fuel filter immediately regardless of maintenance schedule and consult an authorised Kia dealer/service partner for details.

Maintenance under severe usage conditions - except Europe (Including Russia)

I: Inspect and adjust, correct, clean, or replace if necessary.

R: Replace or change.

| Maintenance item | | | Maintenance operation | Maintenance intervals | Driving condition | |
|--------------------------------------|---|------------------------|---|---------------------------------|--|------------------------------------|
| Engine oil and engine oil filter | Petrol | Smartstream G1.6 T-GDI | Except Mexico, China | R | Every 5,000 km (3,000 miles) or 6 months | A, B, C, D, E, F, G, H, I, J, K, L |
| | | | For Mexico, China | | Every 5,000 km (3,000 miles) or 3 months | |
| | | Smartstream G2.0 | Except Middle East, Iran, Morocco, Algeria, Tunisia, Libya, Egypt, Sudan, India, Central & South America, Brazil, Mexico, China | R | Every 7,500 km (5,000 miles) or 6 months | A, B, C, D, E, F, G, H, I, J, K, L |
| | | | For Middle East, Iran, Morocco, Algeria, Tunisia, Libya, Egypt, Sudan, India, Central & South America, Brazil | | Every 5,000 km (3,000 miles) or 6 months | |
| | | | For Mexico, China | | Every 5,000 km (3,000 miles) or 3 months | |
| | | Smartstream G2.5 GDI | Except Middle East, Iran, Morocco, Algeria, Tunisia, Libya, Egypt, Sudan, India, Central & South America, Brazil, Mexico, China | R | Every 7,500 km (5,000 miles) or 6 months | A, B, C, D, E, F, G, H, I, J, K, L |
| | For Middle East, Iran, Morocco, Algeria, Tunisia, Libya, Egypt, Sudan, India, Central & South America, Brazil | | Every 5,000 km (3,000 miles) or 6 months | | | |
| | For Mexico, China | | Every 5,000 km (3,000 miles) or 3 months | | | |
| | Diesel | Smartstream D2.0 | For Russia, Australia, New Zealand and Republic of South Africa | R | Every 7,500 km (4,500 miles) or 6 months | A, B, C, D, E, F, G, H, I, J, K, L |
| | | | Except Russia, Australia, New Zealand and Republic of South Africa | | Every 5,000 km (3,000 miles) or 6 months | |
| Spark plugs | Petrol | | R | More frequently | A, B, F, G, H, I, K | |
| Automatic transmission (AT) fluid | Petrol, Diesel | | R | Every 90,000 km (60,000 miles) | A, C, F, G, H, I, J, K | |
| Dual clutch transmission (DCT) fluid | Petrol | | R | Every 120,000 km (80,000 miles) | C, D, F, G, H, I, J | |
| Manual transmission (MT) fluid | Petrol | | R | Every 120,000 km (80,000 miles) | C, D, F, G, H, I, J | |
| Drive shaft and boots | Petrol, Diesel | | I | More frequently | C, D, E, F, G, H, I, J | |
| Propeller shaft (AWD) | Petrol, Diesel | | I | More frequently | C, D, E, F, G, H, I, J | |

| Maintenance item | | Maintenance operation | Maintenance intervals | Driving condition |
|---------------------------------------|----------------|-----------------------|--|------------------------|
| Rear differential oil (AWD) | Petrol, Diesel | R | Every 120,000 km (80,000 miles) | C, E, G, H, I, J |
| Transfer case oil (AWD) | Petrol, Diesel | R | Every 120,000 km (80,000 miles) | C, E, G, H, I, J |
| Air cleaner filter | Petrol, Diesel | R | More frequently | C, E |
| Climate control air filter | Petrol, Diesel | R | More frequently | C, E, G |
| Brake discs, pads and calipers | Petrol, Diesel | I | More frequently | C, D, E, G, H, I, J, K |
| Parking brake (Foot/Hand type) | Petrol, Diesel | I | More frequently | C, D, G, H |
| Steering gear rack, linkage and boots | Petrol, Diesel | I | More frequently | C, D, E, F, G |
| Suspension ball joints | Petrol, Diesel | I | More frequently | C, D, E, G, H, I |
| ERA-GLONASS system (if equipped) | | I | Every 7,500 km (5,000 miles) or 6 months | A, K |

A: Repeated driving short distance of less than 8 km (5 miles) in normal temperature or less than 16 km (10 miles) in freezing temperature

B: Extensive engine idling or low speed driving for long distances

C: Driving on rough, dusty, muddy, unpaved, gravelled or salt-spread roads

D: Driving in areas using salt or other corrosive materials or in very cold weather

E: Driving in heavy dust condition

F: Driving in heavy traffic area

G: Driving on uphill, downhill, or mountain road repeatedly

H: Using for towing or camping and driving with loading on the roof

I: Driving as a patrol car, taxi, other commercial use of vehicle towing

J: Frequently driving under high speed or rapid acceleration/deceleration

K: Frequently driving in stop-and-go condition

L: Engine oil usage which is not recommended (Mineral type, Semi-synthetic, Lower grade spec, etc.).

Scheduled maintenance service

If your vehicle is operated in any of the severe driving conditions, you should inspect, replace or refill more frequently, using the severe usage maintenance schedule instead of the normal usage maintenance schedule.

Normal maintenance schedule - Non Turbo Model [For Australia and New Zealand]

The following maintenance services must be performed to ensure good emission control and performance. Keep receipts for all vehicle emission services to protect your warranty. Where both mileage and time are shown, the frequency of service is determined by whichever occurs first.

| NO. | Item | Remark |
|-----|---|---|
| 1 | Engine oil and engine oil filter | <ul style="list-style-type: none"> As it is normal for engine oil to be consumed during driving, the engine oil level should be checked on regular basis. The engine oil change interval for normal operating conditions is based on the use of the recommended engine specification. If the recommended engine oil specification is not used, then replace the engine oil according to the maintenance schedule under severe operating conditions. |
| 2 | Engine oil and engine oil filter (Diesel) | <ul style="list-style-type: none"> The engine oil level should be checked regularly and maintained properly. Operating with an insufficient amount of oil can damage the engine, and such damage is not covered by warranty. This maintenance schedule depends on fuel quality. It is applicable only when using a qualified fuel <EN590 or equivalent>. If the diesel fuel specifications don't meet the EN590, it must be replaced according to the severe maintenance schedule. |
| 3 | Coolant (Engine) | When adding coolant, use only deionized water or soft water for your vehicle and never mix hard water in the coolant filled at the factory. An improper coolant mixture can result in serious malfunction or engine damage. |
| 4 | Drive belts (Engine) | <ul style="list-style-type: none"> Adjust alternator, water pump and air conditioner drive belt. Inspect and if necessary repair or replace. Inspect drive belt tensioner, idler and alternator pulley and if necessary correct or replace. |
| 5 | Spark plug | For your convenience, it can be replaced prior to it's interval when you do maintenance of other items. |
| 6 | Rear differential oil (AWD) | Differential oil should be changed anytime it has been submerged in water. |
| 7 | Transfer case oil (AWD) | Transfer case oil should be changed anytime it has been submerged in water. |
| 8 | Fuel filter cartridge (Diesel) | This maintenance schedule depends on fuel quality. It is applicable only when using a qualified fuel <EN590 or equivalent>. If the diesel fuel specifications don't meet the EN590, it must be replaced more frequently. Kia recommend "every 7,500 km (5,000 miles) inspection, every 15,000 km (10,000 miles) replacement". If there are some important safety matters like fuel flow restriction, surging, loss of power, hard starting problem etc, replace the fuel filter immediately regardless of maintenance schedule and consult a professional workshop. Kia recommends to consult an authorised Kia dealer/service partner. |
| * | Transmission fluid | Transmission fluid should be changed anytime it has been submerged in water. |

I: Inspect and adjust, correct, clean, or replace if necessary.

R: Replace or change.

| Normal Maintenance Schedule | | | | | | | | | | |
|---|----------------|--|--|----|----|----|----|-----|-----|-------------------------------|
| Number of months or driving distance, whichever comes first | | | | | | | | | | |
| Months | | 12 | 24 | 36 | 48 | 60 | 72 | 84 | 96 | |
| Km× 1,000 | | 15 | 30 | 45 | 60 | 75 | 90 | 105 | 120 | |
| Engine oil and engine oil filter ¹² | Petrol | Smartstream G2.0 | | | | | | | | R |
| | Diesel | Smartstream D2.0 | | | | | | | | R |
| Coolant (Engine) ³ | Petrol, Diesel | | At first, replace 210,000 km or 120 months After that, replace every 30,000 km or 24 months | | | | | | | |
| Drive belts (Engine) ¹⁴ | Petrol | - | I | - | I | - | I | - | I | |
| | Diesel | At first, inspect 90,000 km or 48 months After that, inspect every 30,000 km or 24 months | | | | | | | | |
| Vacuum hoses and crankcase ventilation hoses | Petrol, Diesel | | - | I | - | I | - | I | - | |
| Spark plugs ⁵ | Petrol | Smartstream G2.0 | | | | | | | | Replace every 150,000 km |
| Automatic transmission (AT) fluid ⁴ | Petrol | Smartstream G2.0 | | | | | | | | No check, No service required |
| | Diesel | Smartstream D2.0 | | | | | | | | |
| Manual transmission (MT) fluid ⁴ | Petrol | Smartstream G2.0 | | | | | | | | No check, No service required |
| Drive shaft and boots | Petrol, Diesel | | - | I | - | I | - | I | - | |
| Propeller shaft (AWD) | Petrol, Diesel | | - | I | - | I | - | I | - | |
| Rear differential oil (AWD) ¹⁶ | Petrol, Diesel | | - | - | - | I | - | - | - | |
| Transfer case oil (AWD) ¹⁷ | Petrol, Diesel | | - | - | - | I | - | - | - | |
| Fuel lines, hoses and connections | Petrol | - | - | - | I | - | - | - | I | |
| | Diesel | - | I | - | I | - | I | - | I | |
| Fuel tank air filter | Petrol | - | I | - | R | - | I | - | R | |
| Vapour hose and fuel filler cap | Petrol | - | - | - | I | - | - | - | I | |
| Fuel filler cap | Diesel | - | - | - | I | - | - | - | I | |
| Fuel filter cartridge ⁸ | Diesel | - | I | - | R | - | I | - | R | |
| Air cleaner filter | Petrol, Diesel | | I | I | R | I | I | R | I | |
| Exhaust system | Petrol, Diesel | | - | I | - | I | - | I | - | |
| Cooling system | Petrol, Diesel | | - | - | - | I | - | I | - | |
| Air conditioner compressor/refrigerant | Petrol, Diesel | | I | I | I | I | I | I | I | |
| Climate control air filter | Petrol, Diesel | | I | R | I | R | I | R | I | |
| Brake discs and pads | Petrol, Diesel | | - | I | - | I | - | I | - | |

| Normal Maintenance Schedule | | | | | | | | | |
|--|----------------|--------------------------|----|----|----|----|----|-----|-----|
| Number of months or driving distance, whichever comes first | | | | | | | | | |
| Months | | 12 | 24 | 36 | 48 | 60 | 72 | 84 | 96 |
| Km× 1,000 | | 15 | 30 | 45 | 60 | 75 | 90 | 105 | 120 |
| Brake lines, hoses and connections | Petrol, Diesel | - | I | - | I | - | I | - | I |
| Brake/clutch fluid | Petrol, Diesel | I | R | I | R | I | R | I | R |
| Parking brake (Hand type) | Petrol, Diesel | - | I | - | I | - | I | - | I |
| Steering gear rack, linkage and boots | Petrol, Diesel | I | I | I | I | I | I | I | I |
| Suspension ball joints | Petrol, Diesel | I | I | I | I | I | I | I | I |
| Tyre (pressure & tread wear) | Petrol, Diesel | I | I | I | I | I | I | I | I |
| Battery (12V) condition | Petrol, Diesel | - | I | - | I | - | I | - | I |
| Timing belt | Diesel | Inspect every 120,000 km | | | | | | | |
| Timing belt system (Timing belt, Water pump, Tensioner, Idler) | Diesel | Replace every 240,000 km | | | | | | | |

- Fuel filter (Petrol engine): The fuel filter is considered to be maintenance free but periodic inspection is recommended for this maintenance schedule depends on fuel quality.
 - If there are some important safety matters like fuel flow restriction, surging, loss of power, hard starting problem etc, replace the fuel filter immediately regardless of maintenance schedule and consult an authorised Kia dealer/service partner for details.

Maintenance under severe usage conditions - Non Turbo Model [For Australia and New Zealand]

I: Inspect and adjust, correct, clean, or replace if necessary.

R: Replace or change.

| Maintenance item | | Maintenance operation | Maintenance intervals | Driving condition | |
|---------------------------------------|----------------|-----------------------|-----------------------|----------------------------|------------------------------------|
| Engine oil and engine oil filter | Petrol | Smartstream G2.0 | R | Every 7,500 km or 6 months | A, B, C, D, E, F, G, H, I, J, K, L |
| | Diesel | Smartstream D2.0 | R | Every 7,500 km or 6 months | A, B, C, D, E, F, G, H, I, J, K, L |
| Spark plugs | Petrol | | R | More frequently | A, B, F, G, H, I, K |
| Automatic transmission (AT) fluid | Petrol, Diesel | | R | Every 90,000 km | A, C, F, G, H, I, J, K |
| Manual transmission (MT) fluid | Petrol | | R | Every 120,000 km | C, D, F, G, H, I, J |
| Drive shaft and boots | Petrol, Diesel | | I | More frequently | C, D, E, F, G, H, I, J |
| Propeller shaft (AWD) | Petrol, Diesel | | I | More frequently | C, D, E, F, G, H, I, J |
| Rear differential oil (AWD) | Petrol, Diesel | | R | Every 120,000 km | C, E, G, H, I, J |
| Transfer case oil (AWD) | Petrol, Diesel | | R | Every 120,000 km | C, E, G, H, I, J |
| Air cleaner filter | Petrol, Diesel | | R | More frequently | C, E |
| Climate control air filter | Petrol, Diesel | | R | More frequently | C, E, G |
| Brake discs, pads and calipers | Petrol, Diesel | | I | More frequently | C, D, E, G, H, I, J, K |
| Parking brake (Hand type) | Petrol, Diesel | | I | More frequently | C, D, G, H |
| Steering gear rack, linkage and boots | Petrol, Diesel | | I | More frequently | C, D, E, F, G |
| Suspension ball joints | Petrol, Diesel | | I | More frequently | C, D, E, G, H, I |

A: Repeated driving short distance of less than 8 km (5 miles) in normal temperature or less than 16 km (10 miles) in freezing temperature

B: Extensive engine idling or low speed driving for long distances

C: Driving on rough, dusty, muddy, unpaved, gravelled or salt-spread roads

D: Driving in areas using salt or other corrosive materials or in very cold weather

E: Driving in heavy dust condition

F: Driving in heavy traffic area

G: Driving on uphill, downhill, or mountain road repeatedly

H: Using for towing or camping and driving with loading on the roof

I: Driving as a patrol car, taxi, other commercial use of vehicle towing

J: Frequently driving under high speed or rapid acceleration/deceleration

K: Frequently driving in stop-and-go condition

L: Engine oil usage which is not recommended (Mineral type, Semi-synthetic, Lower grade spec, etc.).

Normal maintenance schedule - Turbo Model [For Australia and New Zealand]

The following maintenance services must be performed to ensure good emission control and performance. Keep receipts for all vehicle emission services to protect your warranty. Where both mileage and time are shown, the frequency of service is determined by whichever occurs first.

| NO. | Item | Remark |
|-----|----------------------------------|---|
| 1 | Engine oil and engine oil filter | <ul style="list-style-type: none"> As it is normal for engine oil to be consumed during driving, the engine oil level should be checked on regular basis. The engine oil change interval for normal operating conditions is based on the use of the recommended engine specification. If the recommended engine oil specification is not used, then replace the engine oil according to the maintenance schedule under severe operating conditions. |
| 2 | Coolant (Engine) | When adding coolant, use only deionized water or soft water for your vehicle and never mix hard water in the coolant filled at the factory. An improper coolant mixture can result in serious malfunction or engine damage. |
| 3 | Drive belts (Engine) | <ul style="list-style-type: none"> Adjust alternator, water pump and air conditioner drive belt. Inspect and if necessary repair or replace. Inspect drive belt tensioner, idler and alternator pulley and if necessary correct or replace. |
| 4 | Spark plug | For your convenience, it can be replaced prior to it's interval when you do maintenance of other items. |
| 5 | Rear differential oil (AWD) | Differential oil should be changed anytime it has been submerged in water. |
| 6 | Transfer case oil (AWD) | Transfer case oil should be changed anytime it has been submerged in water. |
| 7 | Fuel additives | <p>Kia recommends that you use unleaded petrol which has an octane rating of RON (Research Octane Number) 95 / AKI (Anti Knock Index) 91 or higher (for Europe) or Octane Rating of RON (Research Octane Number) 91 / AKI (Anti-Knock Index) 87 or higher (except Europe).</p> <p>For customers who do not use good quality petrols including fuel additives regularly, and have problems starting or the engine does not run smoothly, one bottle of additives should be added to the fuel tank when the engine oil is replaced. Additives are available from a professional workshop along with information on how to use them. Kia recommends to visit an authorised Kia dealer/service partner. Do not mix other additives.</p> |
| * | Transmission fluid | Transmission fluid should be changed anytime it has been submerged in water. |

I: Inspect and adjust, correct, clean, or replace if necessary.

R: Replace or change.

| Normal Maintenance Schedule | | | | | | | | | | |
|---|--------|------------------------|--|----|----|----|----|----|----|----|
| Number of months or driving distance, whichever comes first | | | | | | | | | | |
| Months | | | 12 | 24 | 36 | 48 | 60 | 72 | 84 | 96 |
| Km× 1,000 | | | 10 | 20 | 30 | 40 | 50 | 60 | 70 | 80 |
| Engine oil and engine oil filter ¹ | Petrol | Smartstream G1.6 T-GDi | R | R | R | R | R | R | R | R |
| Coolant (Engine) ² | Petrol | | At first, replace 210,000 km or 120 months After that, replace every 30,000 km or 24 months | | | | | | | |
| Drive belts (Engine) ³ | Petrol | | - | I | - | I | - | I | - | I |
| Vacuum hoses and crankcase ventilation hoses | Petrol | | - | I | - | I | - | I | - | I |
| Spark plugs ⁴ | Petrol | Smartstream G1.6 T-GDi | Replace every 70,000 km | | | | | | | |
| Dual clutch transmission (DCT) fluid | Petrol | | No check, No service required | | | | | | | |
| Drive shaft and boots | Petrol | | - | I | - | I | - | I | - | I |
| Propeller shaft (AWD) | Petrol | | - | I | - | I | - | I | - | I |
| Rear differential oil (AWD) ⁵ | Petrol | | - | - | - | I | - | - | - | I |
| Transfer case oil (AWD) ⁶ | Petrol | | - | - | - | I | - | - | - | I |
| Fuel additives ⁷ | Petrol | Smartstream G1.6 T-GDi | Add every 10,000 km or 12 months | | | | | | | |
| Fuel lines, hoses and connections | Petrol | | - | - | - | I | - | - | - | I |
| Fuel tank air filter | Petrol | | - | I | - | R | - | I | - | R |
| Vapour hose and fuel filler cap | Petrol | | - | - | - | I | - | - | - | I |
| Air cleaner filter | Petrol | | I | I | R | I | I | R | I | I |
| Intercooler, in/out hose, air intakehose | Petrol | Smartstream G1.6 T-GDi | I | I | I | I | I | I | I | I |
| Exhaust system | Petrol | | - | I | - | I | - | I | - | I |
| Cooling system | Petrol | | - | - | - | I | - | I | - | I |
| Air conditioner compressor/refrigerant | Petrol | | I | I | I | I | I | I | I | I |
| Climate control air filter | Petrol | | I | R | I | R | I | R | I | R |
| Brake discs and pads | Petrol | | - | I | - | I | - | I | - | I |
| Brake lines, hoses and connections | Petrol | | - | I | - | I | - | I | - | I |
| Brake fluid | Petrol | | I | R | I | R | I | R | I | R |

| Normal Maintenance Schedule | | | | | | | | | |
|---|--------|----|----|----|----|----|----|----|----|
| Number of months or driving distance, whichever comes first | | | | | | | | | |
| Months | | 12 | 24 | 36 | 48 | 60 | 72 | 84 | 96 |
| Km× 1,000 | | 10 | 20 | 30 | 40 | 50 | 60 | 70 | 80 |
| Parking brake (Hand type) | Petrol | - | | - | | - | | - | |
| Steering gear rack, linkage and boots | Petrol | | | | | | | | |
| Suspension ball joints | Petrol | | | | | | | | |
| Tyre (pressure & tread wear) | Petrol | | | | | | | | |
| Battery (12V) condition | Petrol | - | | - | | - | | - | |

- Fuel filter (Petrol engine): The fuel filter is considered to be maintenance free but periodic inspection is recommended for this maintenance schedule depends on fuel quality.
 - If there are some important safety matters like fuel flow restriction, surging, loss of power, hard starting problem etc, replace the fuel filter immediately regardless of maintenance schedule and consult an authorised Kia dealer/service partner for details.

Maintenance under severe usage conditions - Turbo Model [For Australia and New Zealand]

I: Inspect and adjust, correct, clean, or replace if necessary.
 R: Replace or change.

| Maintenance item | | Maintenance operation | Maintenance intervals | Driving condition |
|---------------------------------------|----------------------------------|-----------------------|----------------------------|------------------------------------|
| Engine oil and engine oil filter | Petrol Smartstream G1.6 T-GDi | R | Every 5,000 km or 6 months | A, B, C, D, E, F, G, H, I, J, K, L |
| Spark plugs | Petrol | R | More frequently | A, B, F, G, H, I, K |
| Dual clutch transmission (DCT) | Petrol | R | Every 120,000 km | C, D, F, G, H, I, J |
| Drive shaft and boots | Petrol | I | More frequently | C, D, E, F, G, H, I, J |
| Propeller shaft (AWD) | Petrol | I | More frequently | C, D, E, F, G, H, I, J |
| Rear differential oil (AWD) | Petrol | R | Every 120,000 km | C, E, G, H, I, J |
| Transfer case oil (AWD) | Petrol | R | Every 120,000 km | C, E, G, H, I, J |
| Air cleaner filter | Petrol | R | More frequently | C, E |
| Climate control air filter | Petrol | R | More frequently | C, E, G |
| Brake discs, pads and callipers | Petrol | I | More frequently | C, D, E, G, H, I, J, K |
| Parking brake (Hand type) | Petrol | I | More frequently | C, D, G, H |
| Steering gear rack, linkage and boots | Petrol | I | More frequently | C, D, E, F, G |
| Suspension ball joints | Petrol | I | More frequently | C, D, E, G, H, I |

A: Repeated driving short distance of less than 8 km (5 miles) in normal temperature or less than 16 km (10 miles) in freezing temperature

B: Extensive engine idling or low speed driving for long distances

C: Driving on rough, dusty, muddy, unpaved, gravelled or salt-spread roads

D: Driving in areas using salt or other corrosive materials or in very cold weather

E: Driving in heavy dust condition

F: Driving in heavy traffic area

G: Driving on uphill, downhill, or mountain road repeatedly

H: Using for towing or camping and driving with loading on the roof

I: Driving as a patrol car, taxi, other commercial use of vehicle towing

J: Frequently driving under high speed or rapid acceleration/deceleration

K: Frequently driving in stop-and-go condition

L: Engine oil usage which is not recommended (Mineral type, Semi-synthetic, Lower grade spec, etc.).

Normal maintenance schedule

The following maintenance services must be performed to ensure good emission control and performance. Keep receipts for all vehicle emission services to protect your warranty. Where both mileage and time are shown, the frequency of service is determined by whichever occurs first.

| NO. | Item | Remark |
|-----|---|--|
| 1 | Engine oil and engine oil filter | <ul style="list-style-type: none"> As it is normal for engine oil to be consumed during driving, the engine oil level should be checked on regular basis. The engine oil change interval for normal operating conditions is based on the use of the recommended engine specification. If the recommended engine oil specification is not used, then replace the engine oil according to the maintenance schedule under severe operating conditions. |
| 2 | Engine oil and engine oil filter (Diesel) | <ul style="list-style-type: none"> The engine oil level should be checked regularly and maintained properly. Operating with an insufficient amount of oil can damage the engine, and such damage is not covered by warranty. This maintenance schedule depends on fuel quality. It is applicable only when using a qualified fuel <"EN590 or equivalent">. If the diesel fuel specifications don't meet the EN590, it must be replaced according to the severe maintenance schedule. |
| 3 | Coolant (Engine) | When adding coolant, use only deionized water or soft water for your vehicle and never mix hard water in the coolant filled at the factory. An improper coolant mixture can result in serious malfunction or engine damage. |
| 4 | Drive belts (Engine) | <ul style="list-style-type: none"> Adjust alternator, water pump and air conditioner drive belt. Inspect and if necessary repair or replace. Inspect drive belt tensioner, idler and alternator pulley and if necessary correct or replace. |
| 5 | Spark plug | For your convenience, it can be replaced prior to its interval when you do maintenance of other items. |
| 6 | Rear differential oil (AWD) | Differential oil should be changed anytime it has been submerged in water. |
| 7 | Transfer case oil (AWD) | Transfer case oil should be changed anytime it has been submerged in water. |
| 8 | Fuel additives | Kia recommends that you use unleaded petrol which has an octane rating of RON (Research Octane Number) 95 / AKI (Anti Knock Index) 91 or higher (for Europe) or Octane Rating of RON (Research Octane Number) 91 / AKI (Anti-Knock Index) 87 or higher (except Europe). For customers who do not use good quality petrols including fuel additives regularly, and have problems starting or the engine does not run smoothly, one bottle of additives should be added to the fuel tank when the engine oil is replaced. Additives are available from a professional workshop along with information on how to use them. Kia recommends to visit an authorised Kia dealer/service partner. Do not mix other additives. |
| 9 | Fuel filter cartridge (Diesel) | This maintenance schedule depends on fuel quality. It is applicable only when using a qualified fuel <"EN590 or equivalent">. If the diesel fuel specifications don't meet the EN590, it must be replaced more frequently. If there are some important safety matters like fuel flow restriction, surging, loss of power, hard starting problem etc., replace the fuel filter immediately regardless of maintenance schedule and consult a professional workshop for more details. Kia recommends to consult an authorised Kia dealer/service partner. |
| * | Transmission fluid | Transmission fluid should be changed anytime it has been submerged in water. |

I: Inspect and adjust, correct, clean, or replace if necessary.

R: Replace or change.

| Normal Maintenance Schedule | | | | | | | | | | |
|---|--------------------------------|--|---|---|----|----|----|-----|-----|---|
| Number of months or driving distance, whichever comes first | | | | | | | | | | |
| Months | | 12 | 24 | 36 | 48 | 60 | 72 | 84 | 96 | |
| Miles× 1,000 | | 10 | 20 | 30 | 40 | 50 | 60 | 70 | 80 | |
| Km× 1,000 | | 15 | 30 | 45 | 60 | 75 | 90 | 105 | 120 | |
| Engine oil and engine oil filter ¹² | Petrol | Smartstream G1.6 T-GDi | Except Mexico, China | Replace every 10,000 km (6,500 miles) or 12 months | | | | | | |
| | | | For Mexico | Replace every 10,000 km (6,500 miles) or 6 months | | | | | | |
| | | | For China | Replace every 5,000 km (3,000 miles) or 6 months | | | | | | |
| | Petrol | Smartstream G2.0 | Except Middle East, Iran, Morocco, Algeria, Tunisia, Libya, Egypt, Sudan, India, Central & South America, Brazil, Mexico, China | R | R | R | R | R | R | R |
| | | | For Middle East, Iran, Morocco, Algeria, Tunisia, Libya, Egypt, Sudan, India, Central & South America, Brazil | Replace every 10,000 km (6,500 miles) or 12 months | | | | | | |
| | | | For Mexico | Replace every 10,000 km (6,500 miles) or 6 months | | | | | | |
| | Petrol | Smartstream G2.5 GDi | Except Middle East, Iran, Morocco, Algeria, Tunisia, Libya, Egypt, Sudan, India, Central & South America, Brazil, Mexico, China | R | R | R | R | R | R | R |
| | | | For Middle East, Iran, Morocco, Algeria, Tunisia, Libya, Egypt, Sudan, India, Central & South America, Brazil | Replace every 10,000 km (6,500 miles) or 12 months | | | | | | |
| | | | For Mexico | Replace every 10,000 km (6,500 miles) or 6 months | | | | | | |
| | Diesel | Smartstream D2.0 | For Russia, Australia, New Zealand and Republic of South Africa | R | R | R | R | R | R | R |
| | | | Except Russia, Australia, New Zealand and Republic of South Africa | Replace every 10,000 km (6,500 miles) or 12 months | | | | | | |
| | Coolant (Engine) ¹³ | Petrol, Diesel | | At first, Replace 210,000 km (140,000 miles) or 120 months After that, replace every 30,000 km (20,000 miles) or 24 months | | | | | | |
| Drive belts (Engine) ¹⁴ | Petrol | | - | I | - | I | - | I | - | |
| | Diesel | For Russia, Australia, New Zealand and Republic of South Africa | At first, Inspect 90,000 km (60,000 miles) or 48 months After that, Inspect every 30,000 km (20,000 miles) or 24 months | | | | | | | |
| Diesel | | Except Russia, Australia, New Zealand and Republic of South Africa | At first, Inspect 80,000 km (50,000 miles) or 48 months After that, Inspect every 20,000 km (13,000 miles) or 12 months | | | | | | | |

| Normal Maintenance Schedule | | | | | | | | | | | |
|---|--|------------------------|---|---|----|----|----|----|----|-----|-----|
| Number of months or driving distance, whichever comes first | | | | | | | | | | | |
| Months | | | | 12 | 24 | 36 | 48 | 60 | 72 | 84 | 96 |
| Miles× 1,000 | | | | 10 | 20 | 30 | 40 | 50 | 60 | 70 | 80 |
| Km× 1,000 | | | | 15 | 30 | 45 | 60 | 75 | 90 | 105 | 120 |
| Vacuum hoses and crankcase ventilation hoses | Petrol | | | - | | - | | - | | - | |
| Spark plugs ⁵ | Petrol | Smartstream G1.6 T-GDi | Unleaded | Replace every 70,000 km (45,500 miles) | | | | | | | |
| | | Smartstream G2.0 | Unleaded | Replace every 150,000 km (100,000 miles) | | | | | | | |
| | | Smartstream G2.5 GDi | Unleaded | Replace every 150,000 km (100,000 miles) | | | | | | | |
| Automatic transmission (AT) fluid [†] | Petrol, Diesel | | | No check, No service required | | | | | | | |
| Dual clutch transmission (DCT) fluid [†] | Petrol | | | - | - | - | | - | - | - | |
| Manual transmission (MT) fluid [†] | Petrol | | | - | - | - | | - | - | - | |
| Drive shaft and boots | Petrol, Diesel | | | - | | - | | - | | - | |
| Propeller shaft (AWD) | Petrol, Diesel | | | - | | - | | - | | - | |
| Rear differential oil (AWD) ⁶ | Petrol, Diesel | | | - | - | - | | - | - | - | |
| Transfer case oil (AWD) ⁷ | Petrol, Diesel | | | - | - | - | | - | - | - | |
| Fuel additives ⁸ | Petrol | Smartstream G1.6 T-GDi | Except Mexico, China | Add every 10,000 km (6,500 miles) or 12 months | | | | | | | |
| | | | For Mexico | Add every 10,000 km (6,500 miles) or 6 months | | | | | | | |
| | | | For China | Add every 5,000 km (3,000 miles) or 6 months | | | | | | | |
| | | Smartstream G2.5 GDi | Except Middle East, Iran, Morocco, Algeria, Tunisia, Libya, Egypt, Sudan, India, Central & South America, Brazil, Mexico, China | Add every 15,000 km (10,000 miles) or 12 months | | | | | | | |
| | | | For Middle East, Iran, Morocco, Algeria, Tunisia, Libya, Egypt, Sudan, India, Central & South America, Brazil | Add every 10,000 km (6,500 miles) or 12 months | | | | | | | |
| | | | For Mexico | Add every 10,000 km (6,500 miles) or 6 months | | | | | | | |
| For China | Add every 5,000 km (3,000 miles) or 6 months | | | | | | | | | | |
| Fuel filter [†] | Petrol | | | - | | - | R | - | | - | R |
| Fuel lines, hoses and connections | Petrol | | | - | - | - | | - | - | - | |
| | Diesel | | | - | | - | | - | | - | |

| Normal Maintenance Schedule | | | | | | | | | | |
|---|----------------|---|---|--|----|----|----|-----|-----|---|
| Number of months or driving distance, whichever comes first | | | | | | | | | | |
| Months | | 12 | 24 | 36 | 48 | 60 | 72 | 84 | 96 | |
| Miles× 1,000 | | 10 | 20 | 30 | 40 | 50 | 60 | 70 | 80 | |
| Km× 1,000 | | 15 | 30 | 45 | 60 | 75 | 90 | 105 | 120 | |
| Fuel tank air filter | Petrol | Except China | - | I | - | R | - | I | - | R |
| | | For China | I | I | R | I | I | R | I | I |
| Vapour hose and fuel filler cap | Petrol | - | - | - | I | - | - | - | I | |
| Fuel filler cap | Diesel | - | - | - | I | - | - | - | I | |
| Fuel filter cartridge ⁹ | Diesel | - | I | - | R | - | I | - | R | |
| Air cleaner filter | Petrol, Diesel | Except India, Middle East | I | I | R | I | I | R | I | I |
| | | For India, Middle East | R | R | R | R | R | R | R | R |
| Intercooler, in/out hose, air intake-hose | Petrol | Smartstream G1.6 T-GDi | | Inspect every 10,000 km (6,500 miles) or 12 months | | | | | | |
| Exhaust system | Petrol, Diesel | - | I | - | I | - | I | - | I | |
| Cooling system | Petrol, Diesel | - | - | - | I | - | I | - | I | |
| Air conditioner compressor/refrigerant | Petrol, Diesel | I | I | I | I | I | I | I | I | |
| Climate control air filter | Petrol, Diesel | Except Australia and New Zealand | R | R | R | R | R | R | R | |
| | | For Australia and New Zealand | I | R | I | R | I | R | I | R |
| Brake discs and pads | Petrol, Diesel | - | I | - | I | - | I | - | I | |
| Brake lines, hoses and connections | Petrol, Diesel | - | I | - | I | - | I | - | I | |
| Brake/clutch fluid | Petrol, Diesel | Except Australia and New Zealand | I | I | R | I | I | R | I | I |
| | | For Australia and New Zealand | I | R | I | R | I | R | I | R |
| Parking brake (Foot/Hand type) | Petrol, Diesel | - | I | - | I | - | I | - | I | |
| Steering gear rack, linkage and boots | Petrol, Diesel | I | I | I | I | I | I | I | I | |
| Suspension ball joints | Petrol, Diesel | I | I | I | I | I | I | I | I | |
| Tyre (pressure & tread wear) | Petrol, Diesel | I | I | I | I | I | I | I | I | |
| Battery (12V) condition | Petrol, Diesel | Except Middle East | - | I | - | I | - | I | - | I |
| | | For Middle East | Inspect every 10,000 km (6,500 miles) or 6 months | | | | | | | |
| Urea solution line & connections | Diesel | - | I | - | I | - | I | - | I | |
| Urea solution filler cap | Diesel | - | I | - | I | - | I | - | I | |
| Timing belt | Diesel | Inspect every 120,000 km (80,000 miles) | | | | | | | | |

| Normal Maintenance Schedule | | | | | | | | | |
|--|--------|--|----|----|----|----|----|-----|-----|
| Number of months or driving distance, whichever comes first | | | | | | | | | |
| Months | | 12 | 24 | 36 | 48 | 60 | 72 | 84 | 96 |
| Miles× 1,000 | | 10 | 20 | 30 | 40 | 50 | 60 | 70 | 80 |
| Km× 1,000 | | 15 | 30 | 45 | 60 | 75 | 90 | 105 | 120 |
| Timing belt system (Timing belt, Water pump, Tensioner, Idler) | Diesel | Replace every 240,000 km (160,000 miles) | | | | | | | |
| ERA-GLONASS system (if equipped) | | | | | | | | | |
| ERA-GLONASS system battery (if equipped) | | Replace every 3 years | | | | | | | |

* The fuel filter is considered to be maintenance free but periodic inspection is recommended for this maintenance schedule depends on fuel quality. If there are some important safety matters like fuel flow restriction, surging, loss of power, hard starting problem etc, replace the fuel filter immediately regardless of maintenance schedule and consult an authorised Kia dealer/service partner for details.

Maintenance under severe usage conditions

I: Inspect and adjust, correct, clean, or replace if necessary.

R: Replace or change.

| Maintenance item | | | Maintenance operation | Maintenance intervals | Driving condition | |
|--------------------------------------|---|------------------------|---|---------------------------------|--|------------------------------------|
| Engine oil and engine oil filter | Petrol | Smartstream G1.6 T-GDi | Except Mexico, China | R | Every 5,000 km (3,000 miles) or 6 months | A, B, C, D, E, F, G, H, I, J, K, L |
| | | | For Mexico, China | | Every 5,000 km (3,000 miles) or 3 months | |
| | | Smartstream G2.0 | Except Middle East, Iran, Morocco, Algeria, Tunisia, Libya, Egypt, Sudan, India, Central & South America, Brazil, Mexico, China | R | Every 7,500 km (5,000 miles) or 6 months | A, B, C, D, E, F, G, H, I, J, K, L |
| | | | For Middle East, Iran, Morocco, Algeria, Tunisia, Libya, Egypt, Sudan, India, Central & South America, Brazil | | Every 5,000 km (3,000 miles) or 6 months | |
| | | | For Mexico, China | | Every 5,000 km (3,000 miles) or 3 months | |
| | | Smartstream G2.5 GDi | Except Middle East, Iran, Morocco, Algeria, Tunisia, Libya, Egypt, Sudan, India, Central & South America, Brazil, Mexico, China | R | Every 7,500 km (5,000 miles) or 6 months | A, B, C, D, E, F, G, H, I, J, K, L |
| | For Middle East, Iran, Morocco, Algeria, Tunisia, Libya, Egypt, Sudan, India, Central & South America, Brazil | | Every 5,000 km (3,000 miles) or 6 months | | | |
| | For Mexico, China | | Every 5,000 km (3,000 miles) or 3 months | | | |
| | Diesel | Smartstream D2.0 | For Russia, Australia, New Zealand and Republic of South Africa | R | Every 7,500 km (4,500 miles) or 6 months | A, B, C, D, E, F, G, H, I, J, K, L |
| | | | Except Russia, Australia, New Zealand and Republic of South Africa | | Every 5,000 km (3,000 miles) or 6 months | |
| Spark plugs | Petrol | | R | More frequently | A, B, F, G, H, I, K | |
| Automatic transmission (AT) fluid | Petrol, Diesel | | R | Every 90,000 km (60,000 miles) | A, C, F, G, H, I, J, K | |
| Dual clutch transmission (DCT) fluid | Petrol | | R | Every 120,000 km (80,000 miles) | C, D, F, G, H, I, J | |
| Manual transmission (MT) fluid | Petrol | | R | Every 120,000 km (80,000 miles) | C, D, F, G, H, I, J | |
| Drive shaft and boots | Petrol, Diesel | | I | More frequently | C, D, E, F, G, H, I, J | |
| Propeller shaft (AWD) | Petrol, Diesel | | I | More frequently | C, D, E, F, G, H, I, J | |

| Maintenance item | | Maintenance operation | Maintenance intervals | Driving condition |
|---------------------------------------|----------------|-----------------------|--|------------------------|
| Rear differential oil (AWD) | Petrol, Diesel | R | Every 120,000 km (80,000 miles) | C, E, G, H, I, J |
| Transfer case oil (AWD) | Petrol, Diesel | R | Every 120,000 km (80,000 miles) | C, E, G, H, I, J |
| Air cleaner filter | Petrol, Diesel | R | More frequently | C, E |
| Climate control air filter | Petrol, Diesel | R | More frequently | C, E, G |
| Brake discs, pads and calipers | Petrol, Diesel | I | More frequently | C, D, E, G, H, I, J, K |
| Parking brake (Foot/Hand type) | Petrol, Diesel | I | More frequently | C, D, G, H |
| Steering gear rack, linkage and boots | Petrol, Diesel | I | More frequently | C, D, E, F, G |
| Suspension ball joints | Petrol, Diesel | I | More frequently | C, D, E, G, H, I |
| ERA-GLONASS system (if equipped) | | I | Every 7,500 km (5,000 miles) or 6 months | A, L |

A: Repeated driving short distance of less than 8 km (5 miles) in normal temperature or less than 16 km (10 miles) in freezing temperature

B: Extensive engine idling or low speed driving for long distances

C: Driving on rough, dusty, muddy, unpaved, gravelled or salt-spread roads

D: Driving in areas using salt or other corrosive materials or in very cold weather

E: Driving in heavy dust condition

F: Driving in heavy traffic area

G: Driving on uphill, downhill, or mountain road repeatedly

H: Using for towing or camping and driving with loading on the roof

I: Driving as a patrol car, taxi, other commercial use of vehicle towing

J: Frequently driving under high speed or rapid acceleration/deceleration

K: Frequently driving in stop-and-go condition

L: Engine oil usage which is not recommended (Mineral type, Semi-synthetic, Lower grade spec, etc.).

Explanation of scheduled maintenance items

Engine oil and filter

The engine oil and filter should be changed at the intervals specified in the maintenance schedule. If the vehicle is being driven in severe conditions, more frequent oil and filter changes are required.

Drive belts

Inspect all drive belts for evidence of cuts, cracks, excessive wear or oil saturation and replace if necessary. Drive belts should be checked periodically for proper tension and adjusted as necessary.

CAUTION

When you are inspecting the belt, place the ignition switch in the LOCK/OFF or ACC position.

Fuel filter cartridge (for diesel engine)

A clogged filter can limit the speed at which the vehicle may be driven, damage the emission system and cause multiple issues such as hard starting. If an excessive amount of foreign matter accumulates in the fuel tank, the filter may require replacement more frequently.

After installing a new filter, run the engine for several minutes, and check for leaks at the connections. Have the fuel filter replaced by a professional workshop. Kia recommends to visit an authorised Kia dealer/service partner.

Fuel filter (for petrol engine)

Kia petrol vehicles are equipped a lifetime fuel filter that integrated with the

fuel tank. Regular maintenance or replacement is not needed but depends on fuel quality. If there are some important safety matters like fuel flow restriction, surging, loss of power, hard starting problem etc, fuel filter inspection or replace is needed.

Have the fuel filter inspected or replaced by a professional workshop. Kia recommends to visit an authorised Kia dealer/service partner.

Fuel lines, fuel hoses and connections

Check the fuel lines, fuel hoses and connections for leakage and damage. Have the fuel lines, fuel hoses and connections replaced by a professional workshop. Kia recommends to visit an authorised Kia dealer/service partner.

WARNING

Diesel only

Never work on the injection system with the engine running or within 30 seconds after shutting off the engine. High pressure pump, rail, injectors and high pressure pipes are subject to high pressure even after the engine stops. The fuel jet produced by fuel leaks may cause serious injury, if it touches the body. People wearing a cardiac pacemaker should maintain a distance of at least 30 cm from the ECU or wiring harness within the engine room whilst the engine is running, since the high currents in the Common Rail system produce considerable magnetic fields.

Vapour hose and fuel filler cap (for petrol engine)

The vapour hose and fuel filler cap should be inspected at those intervals specified in the maintenance schedule.

Make sure that a new vapour hose or fuel filler cap is correctly replaced.

Vacuum crankcase ventilation hoses (if equipped)

Inspect the surface of hoses for evidence of heat and/or mechanical damage. Hard and brittle rubber, cracking, tears, cuts, abrasions, and excessive swelling indicate deterioration. Particular attention should be paid to examine those hose surfaces nearest to high heat sources, such as the exhaust manifold.

Inspect the hose routing to assure that the hoses do not come in contact with any heat source, sharp edges or moving component which might cause heat damage or mechanical wear. Inspect all hose connections, such as clamps and couplings, to make sure they are secure, and that no leaks are present. Hoses should be replaced immediately if there is any evidence of deterioration or damage.

Air cleaner filter

Have the air cleaner filter replaced by a professional workshop. Kia recommends to visit an authorised Kia dealer/service partner.

Spark plugs (for petrol engine)

Make sure to install new spark plugs of the correct heat range.

When assembling parts, be sure to wipe the inside and outside of the boot bottom of the ignition coil and the insulator of the spark plug with a soft cloth to prevent contamination of the spark plug insulator.

⚠ WARNING

Do not disconnect and inspect spark plugs when the engine is hot. You may burn yourself.

Cooling system

Check the cooling system components, such as the radiator, coolant reservoir, hoses and connections for leakage and damage. Replace any damaged parts.

Coolant

The coolant should be changed at the intervals specified in the maintenance schedule.

Dual clutch transmission (DCT) fluid (if equipped)

Inspect the dual clutch transmission fluid according to the maintenance schedule.

Automatic transmission (AT) fluid (if equipped)

Automatic transmission fluid should not be checked under normal usage conditions. Have the automatic transmission fluid changed by a professional workshop according to the maintenance schedule. Kia recommends to visit an authorised Kia dealer/service partner.

*** NOTICE**

Automatic transmission fluid colour is basically red.

As the vehicle is driven, the automatic transmission fluid will begin to look darker. It is normal condition and you should not judge the need to replace the fluid based upon the changed colour.

⚠ CAUTION

The use of a non-specified fluid could result in transmission malfunction and failure.

Use only specified automatic transmission fluid. (Refer to "Recommended lubricants and capacities" on page 10-7.)

Brake hoses and lines

Visually check for proper installation, chafing, cracks, deterioration and any leakage. Replace any deteriorated or damaged parts immediately.

Brake/clutch fluid

Check the brake/clutch fluid level in the brake fluid reservoir. The level should be between "MIN" and "MAX" marks on the side of the reservoir. Use only hydraulic brake/clutch fluid conforming to DOT 4 specification.

Parking brake

Inspect the parking brake system including the parking brake pedal and cables.

Brake discs, pads and calipers

Check the pads for excessive wear, discs for run out and wear, and calipers for fluid leakage.

For more information on checking the pads or lining wear limit, we recommend to refer to the Kia web site.

(www.kia-hotline.com)

Suspension mounting bolts

Check the suspension connections for looseness or damage. Retighten to the specified torque.

Steering gear box, linkage & boots/lower arm ball joint

With the vehicle stopped and engine off, check for excessive free-play in the steering wheel.

Check the linkage for bends or damage. Check the dust boots and ball joints for deterioration, cracks, or damage. Replace any damaged parts.

Drive shafts and boots

Check the drive shafts, boots and clamps for cracks, deterioration, or damage. Replace any damaged parts and, if necessary, repack the grease.

Air conditioning refrigerant

Check the air conditioning lines and connections for leakage and damage.

Propeller shaft (if equipped)

Check the propeller shaft, boots, clamps, rubber coupling and centre bearing rubber for cracks, deterioration, or damage. Replace any damaged parts and if necessary, repack the grease.

Checking fluid levels

When checking engine oil, engine coolant, brake fluid, and washer fluid, always be sure to clean the area around any filler plug, drain plug, or dipstick before checking or draining any lubricant or fluid. This is especially important in dusty or sandy areas and when the vehicle is used on unpaved roads. Cleaning the plug and dipstick areas will prevent dirt and grit from entering the engine and other mechanisms that could be damaged.

Engine oil

Checking engine oil level

Engine oil is used for lubricating, cooling, and operating various hydraulic components in the engine. Engine oil consumption whilst driving is normal, and it is necessary to check and refill the engine oil regularly. Also, check and refill the oil level within the recommended maintenance schedule to prevent deterioration of oil performance.

Check the engine oil following the below procedure.

Smartstream G2.5 GDi

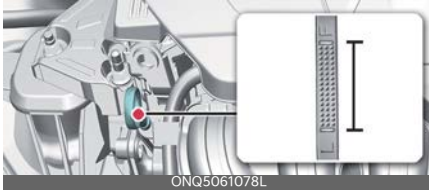

ONQ5061078L

Smartstream G1.6 T-GDi



ONQ5061004L

Smartstream G2.0



ONQ5061079L

Smartstream D2.0



ONQ5061005L

Operation

1. Be sure the vehicle is on level ground.
2. Start the engine and allow it to reach normal operating temperature.
3. Turn the engine off, remove the oil filler cap and pull the dipstick out. Wait for 15 minutes for the oil to return to the oil pan.
4. Wipe the dipstick clean and re-insert it fully.
5. Pull the dipstick out again and check the level.
 - For petrol engine, check if the oil level is between the F-L line, and if it is below the L line, add enough oil to bring the level to F line.
 - For diesel engine, the level should be in the C range. If the level is in the D range, add enough engine oil to bring the level up the range.

| Range | Required action according to the respective engine oil level |
|-------|--|
| A | Contact an authorised Kia dealer/service partner. |
| B | Do not refill oil. |
| C | You may add oil as long as the oil level does not go above C-range. |
| D | You must add oil and make sure that the oil level is in the C-Range. |

Replenishing engine oil

Smartstream G2.5 GDi



Smartstream G1.6 T-GDi

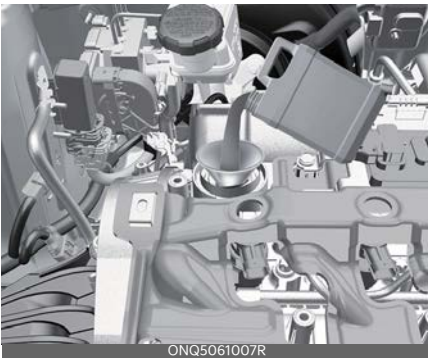

Smartstream G2.0

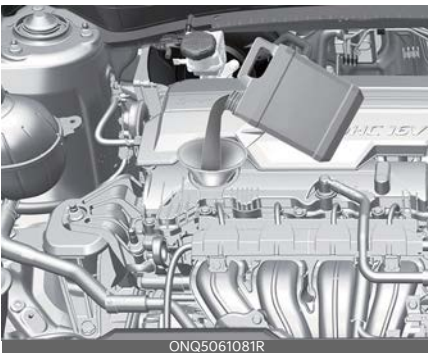

Smartstream D2.0



Use a funnel to help prevent oil from being spilled on engine components.

Use only the specified engine oil. (Refer to "Recommended lubricants and capacities" on page 10-7.)

- Do not spill engine oil when adding or changing engine oil. Wipe off spilled oil immediately.
- The engine oil consumption may increase whilst you break in a new vehicle and it will be stabilized after driving 6,000 km (4,000 miles).
- The engine oil consumption can be affected by driving habits, climate conditions, traffic conditions, oil quality, etc. Therefore, it is recommended that you inspect the engine oil level regularly and refill it if necessary.

Changing engine oil and filter

Have the engine oil and filter replaced by a professional workshop. Kia recommends to visit an authorised Kia dealer/service partner.

- If exceeding the maintenance schedule for replacement of engine oil, the engine oil performance may deteriorate and the engine condition may be affected. Therefore, the replacement cycle should be observed.

- To keep the engine in optimal condition, use recommended engine oil. If not using the recommended oil, replace it according to the severe usage maintenance conditions.
- * The engine oil change interval is set for the purpose of preventing oil deterioration, and is not related the amount of oil consumption; so, check and refill the amount of the oil regularly.

WARNING

- Be very careful not to touch the radiator hose when checking or adding the engine oil as it may be hot enough to burn you.
- Used engine oil may cause irritation or cancer of the skin if left in contact with the skin for prolonged periods of time. Used engine oil contains chemicals that have caused cancer in laboratory animals. Always protect your skin by washing your hands thoroughly with soap and warm water as soon as possible after handling used oil. Do not leave used engine oil within the reach of children.

CAUTION

- When you wipe the oil level gauge, you should wipe it with a clean cloth. When mixed with debris, it can cause engine damage.
- The engine oil is very hot immediately after the vehicle has been driven and can cause burns during replacement. Replace the engine oil after the engine oil has cooled down.

* NOTICE

Never add any additives to the engine oil. Engine oil additives can change the

properties of engine oil and may cause serious engine failure.

* NOTICE

When the oil pressure is low due to insufficient engine oil, the Engine Oil Pressure () warning light will appear.

In addition, the enhanced engine protection system, which limits the engine's power is activated and the Malfunction Indicator Lamp () will appear when the vehicle is driven in this state continuously.

When oil pressure is restored, the Engine Oil Pressure warning light will turn off and the engine power will no longer be limited.

For Smartstream G2.0/Smartstream G2.5 GDi, when the engine oil pressure is restored, the warning light and the enhanced engine protection system will turn off after the engine is restarted.

Engine coolant

Checking coolant level



Check the condition and connections of all cooling system hoses and heater hoses. Replace any swollen or deteriorated hoses.

The coolant level should be filled between MAX and MIN (F and L) marks on the side of the coolant reservoir when the engine is cool.

* INFORMATION

If frequent additions are required, have the system inspected by a professional workshop. Kia recommends to visit an authorised Kia dealer/service partner.

⚠ WARNING



The electric motor (cooling fan) is controlled by engine coolant temperature, refrigerant pressure and vehicle speed. It

may sometimes operate even when the engine is not running. Use extreme caution when working near the blades of the cooling fan so that you are not injured by a rotating fan blades. As the engine coolant temperature decreases, the electric motor will automatically shut off. This is a normal condition. The electric motor (cooling fan) may operate until you disconnect the negative battery cable.

⚠ CAUTION



• Never attempt to remove the radiator cap whilst the engine is operating or hot. Doing so might lead to cooling

system and engine damage. Also, hot coolant or steam could cause serious personal injury. Turn the engine off and wait until it cools down. Use extreme care when removing the radiator cap. Wrap a thick towel around it, and turn it counterclockwise slowly to the first stop. Step back whilst the pressure is released from the cooling system. When you are sure all the pressure has been released, press down on the cap, using a thick towel, and continue turning counterclockwise to remove it. Even if the engine is not operating, do not remove the radiator cap or the drain plug whilst the engine and radiator are hot. Hot coolant and steam may still blow out under pressure, causing serious injury.

- When the engine overheats from low engine coolant, suddenly adding engine coolant may cause cracks in the engine. To prevent damage, add engine coolant slowly in small quantities.
- Do not drive with no engine coolant. It may cause water pump failure and engine seizure, etc.

* NOTICE

Make sure the coolant cap is properly closed after refill of coolant. Otherwise the engine could be overheated whilst driving.

Operation

1. Check if the radiator cap label is straight in front.



2. Make sure that the tiny protrusions inside the coolant cap are securely interlocked.

Recommended engine coolant

- When adding coolant, use only deionized water or soft water for your vehicle and never mix hard water in the coolant filled at the factory.
- Do not use alcohol or methanol coolant or mix them with the specified coolant.
- Do not use a solution that contains more than 60% antifreeze or less than 35% antifreeze.

Refer to the following table for mixture percentage.

| Ambient Temperature | Mixture Percentage (volume) | |
|---------------------|-----------------------------|-------|
| | Antifreeze | Water |
| -15°C (5°F) | 35 | 65 |
| -25°C (-13°F) | 40 | 60 |
| -35°C (-31°F) | 50 | 50 |
| -45°C (-49°F) | 60 | 40 |

⚠ WARNING

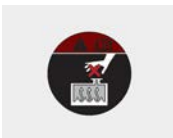

• Do not remove the radiator cap when the engine and radiator are hot. Scalding hot coolant and steam may blow out under pressure causing serious injury.

- Do not use radiator coolant or anti-freeze in the washer fluid reservoir.
- Radiator coolant can severely obscure visibility when sprayed on the wind-screen and may cause loss of vehicle control or damage the paint and body trim.

Changing coolant

Have the coolant replaced by a professional workshop. Kia recommends to visit an authorised Kia dealer/service partner.

⚠ CAUTION

Put a thick cloth around the radiator cap before refilling the coolant in order to prevent the coolant from overflowing into engine parts such as the alternator.

Brake/clutch fluid

Checking brake/clutch fluid level



Operation

1. Clean the area around the reservoir cap.
2. Periodically check that the fluid level in the brake fluid reservoir is between MIN and MAX. The level will fall with accumulated mileage. This is a normal condition associated with the wear of the brake linings.

Check the fluid level in the reservoir periodically. The fluid level should be between MAX and MIN marks on the side of the reservoir. Never mix different types of fluid.

Use only the specified brake fluid. (Refer to "Recommended lubricants and capacities" on page 10-7.)

* INFORMATION

If the fluid level is excessively low, have the system checked by a professional workshop. Kia recommends to visit an authorised Kia dealer/service partner.

⚠ WARNING

- In the event the brake system requires frequent additions of fluid, have the system inspected by a professional workshop. Kia recommends to visit an authorised Kia dealer/service partner.
- When changing and adding brake fluid, handle it carefully. Do not let it

come in contact with your eyes. If brake fluid should come in contact with your eyes, immediately flush them with a large quantity of fresh tap water. Have your eyes examined by a doctor as soon as possible.

⚠ CAUTION

Do not allow brake fluid to contact the vehicle's body paint, as paint damage will result. Brake fluid, which has been exposed to open air for an extended time should never be used as its quality cannot be guaranteed. It should be properly disposed. Don't put in the wrong kind of fluid. A few drops of mineral-based oil, such as engine oil, in your brake system can damage brake system parts.

Washer fluid

Checking washer fluid level



Operation

1. Check the fluid level in the washer fluid reservoir and add fluid if necessary. Plain water may be used if washer fluid is not available.
2. However, use washer solvent with antifreeze characteristics in cold climates to prevent freezing.

The reservoir is translucent so that you can check the level with a quick visual inspection.

⚠ WARNING

- Do not use radiator coolant or anti-freeze in the washer fluid reservoir.
- Radiator coolant can severely obscure visibility when sprayed on the windscreen and may cause loss of vehicle control or damage to paint and body trim.
- Windscreen Washer fluid agents contain some amounts of alcohol and can be flammable under certain circumstances. Do not allow sparks or flame to contact the washer fluid or the washer fluid reservoir. Damage to the vehicle or occupants could occur.
- Windscreen washer fluid is poisonous to humans and animals. Do not drink and avoid contacting windscreen washer fluid. Serious injury or death could occur.

Parking brake

Checking the parking brake (Hand type)



Check the stroke of the parking brake by counting the number of "clicks" heard whilst fully applying it from the released position. Also, the parking brake alone should securely hold the vehicle on a fairly steep grade. If the stroke is more or less than specified, we recommend that the system be inspected by an authorised Kia dealer/service partner.

Stroke: 5~6 click at a force of 20 kgf (44 lbf, 196 N).

Checking the parking brake (Foot type)



Operation

1. Check whether the stroke is within specification when the parking brake pedal is depressed with 30 kg (66 lb, 294 N) of force.
2. Also, the parking brake alone should securely hold the vehicle on a fairly steep grade.

If the stroke is more or less than specified, have the system serviced by a professional workshop. Kia recommends to visit an authorised Kia dealer/service partner.

Stroke: 5~6 click at a force of 30kgf

Fuel filter (Diesel)

Draining water from fuel filter

Condition(s)

- If water accumulates in the fuel filter, the fuel filter warning light (🚫) comes on.

Operation

- Take your vehicle to a professional workshop, have the water drained and check the system. Kia recommends to visit an authorised Kia dealer/service partner.

Replacing fuel filter cartridge

Operation

- Have the fuel filter cartridge replaced by a professional workshop. Kia recommends to visit an authorised Kia dealer/service partner.

⚠ CAUTION

If the water accumulated in the fuel filter is not drained at proper times, damages to the major parts such as the fuel system can be caused by water permeation in the fuel filter.

* NOTICE

When replacing the fuel filter cartridge, use parts for replacement from a professional workshop. Kia recommends to visit an authorised Kia dealer/service partner.

Air cleaner filter

Replacing air cleaner filter

Operation

1. Pull up the lever (1) on the air cleaner cover and release the lock.



2. Rotate the fixed lever on the filter and loosen the lock.



3. Replace the air cleaner filter.



4. Assemble in reverse order.

⚠ CAUTION

- Do not drive with the air cleaner removed; this will result in excessive engine wear.
- When removing the air cleaner filter, be careful that dust or dirt does not enter the air intake, or damage may result.
- Use parts for replacement from a professional workshop. Kia recommends to visit an authorised Kia dealer/service partner.

Climate control air filter

Replacing climate control air filter

Operation

1. Open the glove box and remove the stopper (1).

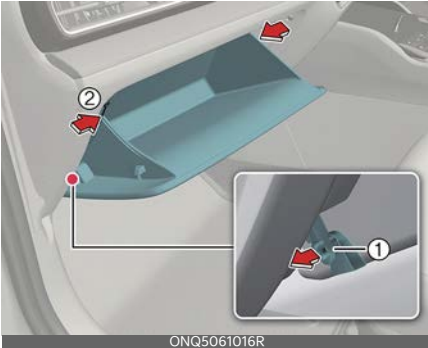

2. With the glove box open, pull the support strap.



3. Remove the climate control air filter cover by pulling out both sides of the cover.



4. Replace the climate control air filter.
5. Assemble in reverse order.

* NOTICE

When replacing the climate control air filter install it properly. Otherwise, the system may produce noise and the effectiveness of the filter may be reduced.

Wiper blades

Replacing front wiper blade



Operation

1. Turn off the vehicle.
2. Move the wiper switch to the single wiping (MIST/1x) position.
3. Hold the wiper switch for more than 2 seconds.

4. Type A (if equipped)

- Raise the wiper arm.
- Lift the wiper blade clip up. Pull down the blade assembly and remove it.



- Install the new blade assembly.



5. Type B (if equipped)

- Raise the wiper arm and turn the wiper blade assembly to expose the plastic locking clip.



- Compress the clip and slide the blade assembly downward.



- Lift it off the arm.
 - Install the blade assembly in the reverse order of removal.
6. Return the wiper arm on the wind-screen.
 7. Turn the vehicle on and wiper arms will return to the normal operating position.

Replacing rear wiper blade



Operation

1. Turn off the vehicle.
2. Move the wiper switch to the single wiping (MIST) position.
3. Hold the wiper switch for more than 2 seconds.
4. Raise the wiper arm and pull out the wiper blade assembly.



5. Lift up the wiper blade, and pull the blade to remove it.

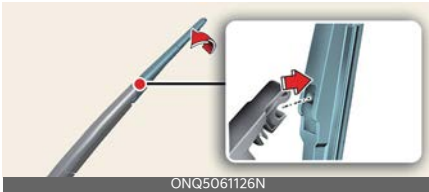

6. Install the new blade assembly by inserting the centre part into the slot in the wiper arm until it clicks into place.

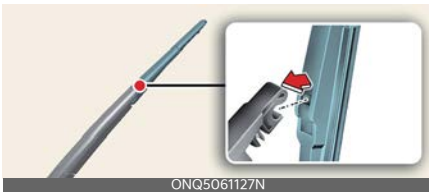

If the replacement is complete, put down the wiper arm to place it on the rear windscreen, and turn the vehicle ignition to ON and operate the wipers to check the blade is installed correctly.

7. Make sure the blade assembly is installed firmly by trying to pull it slightly.

* INFORMATION

To prevent damage to the wiper arms or other components, have the wiper blade replaced by a professional workshop. Kia recommends to visit an authorised Kia dealer/service partner.

⚠ CAUTION

- Do not use petrol, kerosene, paint thinner, or other solvents on or near them.
- Do not attempt to move the wipers manually.
- The use of a non-specified wiper blade could result in wiper malfunction and failure.
- Do not allow the wiper arm to fall against the windscreen, since it may chip or crack the windscreen.
- If the wiper arm receives too much force whilst pulling the blade, the centre part may be damaged.
- The wiper could not operate for approximately 10 seconds when the wiper is operated without washer fluid or the blades are frozen. This is not a malfunction, it is a wiper protection system activated by motor overload circuit within the wiper motor.
- The front windscreen should be cleaned with water hose and wiped with clean towel with wiper blades raised up. Also, the wiper blades should be wiped clean when the grease or wax is applied to the blades.

* NOTICE

Commercial hot waxes applied by automatic car washes have been known to make the windscreen difficult to clean. And it is the responsibility of customers to wash and manage the vehicle with adequate methods and materials.

Battery

For best battery service



- Keep the battery securely mounted.
- Keep the battery top clean and dry.
- Keep the terminals and connections clean, tight, and coated with petroleum jelly or terminal grease.
- Rinse any spilled electrolyte from the battery immediately with a solution of water and baking soda.
- If the vehicle is not going to be used for an extended time, disconnect the battery cables.

⚠ WARNING



Always read the following instructions carefully when handling a battery.



Keep lighted cigarettes and all other flames or sparks away from the battery.



Hydrogen, a highly combustible gas, is always present in battery cells and may explode if ignited.



Keep batteries out of the reach of children because batteries contain highly corrosive SULFURIC ACID. Do not allow battery

acid to contact your skin, eyes, clothing or paint finish.



If any electrolyte gets into your eyes, flush your eyes with clean water for at least 15 minutes and get immediate medical attention.

If electrolyte gets on your skin, thoroughly wash the contacted area. If you feel pain or burning sensation, get medical attention immediately.



Wear eye protection when charging or working near a battery. Always provide ventilation when working in an enclosed

space.



An inappropriately disposed battery can be harmful to the environment and human health.

Dispose the battery according to your local law(s) or regulation.

- When lifting a plastic-cased battery, excessive pressure on the case may cause battery acid to leak, resulting in personal injury. Lift with a battery carrier or with your hands on opposite corners.
- Never attempt to recharge the battery when the battery cables are connected.
- The electrical ignition system works with high voltage. Never touch these components with the engine running or the ignition switched on.

Failure to follow the above warnings can result in serious bodily injury or death.

⚠ CAUTION

If you connect unauthorised electronic devices to the battery, the battery may be discharged. Never use unauthorised devices.

*** NOTICE**

Your vehicle is equipped with maintenance free battery. If your vehicle is equipped with the battery marked with LOWER and UPPER on the side, you can check the electrolyte level. The electro-

lyte level should be between LOWER and UPPER. If the electrolyte level is low, it needs to add distilled (demineralized) water (Never add sulfuric acid or other electrolyte). When refill, be careful not to splash the battery and adjacent components. And do not overfill the battery cells. It can cause corrosion on other parts. Make sure that the cell caps are tightened.

Contact a professional workshop. Kia recommends to visit an authorised Kia dealer/service partner.

Battery capacity label

Example



* The actual battery label in the vehicle may differ from the illustration.

1. The Kia model name of battery
2. The nominal capacity (in Ampere hours)
3. The nominal reserve capacity (in min.)
4. The nominal voltage
5. The cold-test current in amperes by SAE
6. The cold-test current in amperes by EN

Battery recharging

Your vehicle has a maintenance-free, calcium-based battery.

- If the battery becomes discharged in a short time (because, for example, the headlights or interior lights were left on whilst the vehicle was not in use),

recharge it by slow charging (trickle) for 10 hours.

- If the battery gradually discharges because of high electric load whilst the vehicle is being used, recharge it at 20~30 A for two hours.

⚠ WARNING

- When recharging the battery, observe the following precautions:
 - The battery must be removed from the vehicle and placed in an area with good ventilation.
 - Do not allow cigarettes, sparks, or flame near the battery.
 - Watch the battery during charging, and stop or reduce the charging rate if the battery cells begin gassing (boiling) violently or if the temperature of the electrolyte of any cell exceeds 49°C (120°F).
 - Wear eye protection when checking the battery during charging.
 - Disconnect the battery charger in the following order.
 1. Turn off the battery charger main switch.
 2. Unhook the negative clamp from the negative battery terminal.
 3. Unhook the positive clamp from the positive battery terminal.
- Before performing maintenance or recharging the battery, turn off all accessories and stop the engine.
- The negative battery cable must be removed first and installed last when the battery is disconnected.

⚠ CAUTION

Do not open or remove the cap on top of the battery. This may cause leaks of

internal electrolyte that could result in severe injury.

Reset items

Items should be reset after the battery has been discharged or the battery has been disconnected.

- Auto up/down window
- Panorama sunroof
- Trip computer
- Climate control system
- Driver position memory system
- Integrated memory system
- Infotainment system
- Audio

Tyres and wheels

Tyre care

For proper maintenance, safety, and maximum fuel economy, you must always maintain recommended tyre inflation pressures and stay within the load limits and weight distribution recommended for your vehicle.

Recommended cold tyre inflation pressures



All specifications (sizes and pressures) can be found on a label attached to the vehicle.

* INFORMATION

All tyre pressures (including the spare) should be checked when the tyres are cold. "Cold Tyres" means the vehicle has not been driven for at least three hours or driven less than 1.6 km (one mile).

Checking tyre inflation pressure

- Remove the valve cap from the tyre valve stem. Press the tyre gauge firmly onto the valve to get a pressure measurement. If the pressure is low, add air until you reach the recommended amount.
- If you overfill the tyre, release air by pushing on the metal stem in the centre of the tyre valve. Be sure to put the valve caps back on the valve stems.

⚠ WARNING

- Overinflation or underinflation can reduce tyre life, adversely affect vehicle handling, and lead to sudden tyre failure. This could result in loss of vehicle control and potential injury.
- Severe underinflation (70 kPa (10 psi) or more) can lead to severe heat build-up, causing blowouts, tread separation and other tyre failures that can result in the loss of vehicle control leading to severe injury or death. This risk is much higher on hot days and when driving for long periods at high speeds.
- Inspect your tyres frequently for proper inflation as well as wear and damage. Always use a tyre pressure gauge.
- Tyres with too much or too little pressure wear unevenly causing poor handling, loss of vehicle control, and sudden tyre failure leading to accidents, injuries, and even death. The recommended cold tyre pressure for your vehicle can be found in this manual and on the tyre label located on the driver's side centre pillar.
- Worn tyres can cause accidents. Replace tyres that are worn, show uneven wear, or are damaged.
- Remember to check the pressure of your spare tyre. Kia recommends that you check the spare every time you check the pressure of the other tyres on your vehicle.

⚠ CAUTION

- Underinflation also results in excessive wear, poor handling and reduced fuel economy. Wheel deformation also is possible. Keep your tyre pres-

ures at the proper levels. If a tyre frequently needs refilling, have the system checked by a professional workshop. Kia recommends to visit an authorised Kia dealer/service partner.

- Overinflation produces a harsh ride, excessive wear at the centre of the tyre tread, and a greater possibility of damage from road hazards.
- Warm tyres normally exceed recommended cold tyre pressures by 28 to 41 kPa (4 to 6 psi). Do not release air from warm tyres to adjust the pressure or the tyres will be underinflated.
- Be sure to reinstall the tyre inflation valve caps. Without the valve cap, dirt or moisture could get into the valve core and cause air leakage. If a valve cap is missing, install a new one as soon as possible.
- Always observe the following:
 - Check tyre pressure when the tyres are cold. (After vehicle has been parked for at least three hours or hasn't been driven more than 1.6 km (one mile) since startup.)
 - Check the pressure of your spare tyre each time you check the pressure of other tyres.
 - Never overload your vehicle. Be careful not to overload a vehicle luggage rack if your vehicle is equipped with one.
 - Worn, old tyres can cause accidents. If your tread is badly worn, or if your tyres have been damaged, replace them.

Tyre rotation

With a full-size spare tyre

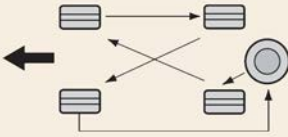

ODEPPH072019L

Without a spare tyre

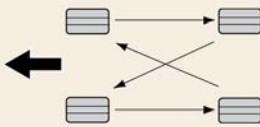

ODEPV072053

Directional tyres

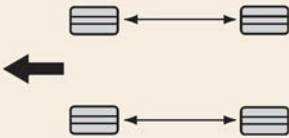

ODEPPH072020L

To equalize tread wear, it is recommended that the tyres be rotated every 10,000 km (6,500 miles) or sooner if irregular wear develops.

⚠ WARNING

- Do not use the compact spare tyre for tyre rotation.
- Do not mix bias ply and radial ply tyres under any circumstances. This may cause unusual handling characteristics that could result in death, severe injury, or property damage.

*** NOTICE**

Rotate radial tyres that have an asymmetric tread pattern only from front to rear and not from right to left.

Wheel alignment and tyre balance

The wheels on your vehicle were aligned and balanced carefully at the factory to give you the longest tyre life and best overall performance.

If you notice your vehicle vibrating when driving on a smooth road, your wheels may need to be rebalanced.

⚠ CAUTION

Improper wheel weights can damage your vehicle's aluminium wheels. Use only approved wheel weights.

Tyre replacement

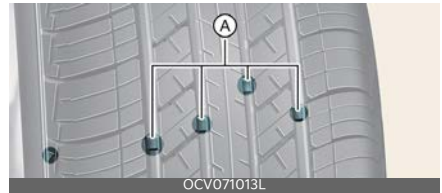

A: Tread wear indicator

If the tyre is worn evenly, a tread wear Indicator will appear as a solid band across the tread.

This shows there is less than 1.6 mm (1/16 in.) of tread left on the tyre. Replace the tyre when this happens.

Do not wait for the band to appear across the entire tread before replacing the tyre.

Compact spare tyre replacement (if equipped)

A compact spare tyre has a shorter tread life than a regular size tyre. Replace it when you can see the tread wear indicator bars on the tyre. The replacement compact spare tyre should be the same size and design tyre as the one provided with your new vehicle and should be mounted on the same compact spare tyre wheel. The compact spare tyre is not designed to be mounted on a regular size wheel, and the compact spare tyre wheel is not designed for mounting a regular size tyre.

WARNING

To reduce the chance of serious or fatal injuries from an accident caused by tyre failure or loss of vehicle control:

- Replace tyres that are worn, show uneven wear, or are damaged. Worn tyres can cause loss of braking effectiveness, steering control, and traction.
- Do not drive your vehicle with too little or too much pressure in your tyres. This can lead to uneven wear and tyre failure.
- When replacing tyres, never mix radial and bias-ply tyres on the same car. You must replace all tyres (including the spare) if moving from radial to bias-ply tyres.
- It is best to replace all four tyres at the same time. If that is not possible, or necessary, then replace the two front or two rear tyres as a pair.
Replacing just one tyre can seriously affect your vehicle's handling.
- Using tyres and wheels other than the recommended sizes could cause unusual handling characteristics and

poor vehicle control, resulting in a serious accident.

- Wheels that do not meet Kia's specifications may fit poorly and result in damage to the vehicle or unusual handling and poor vehicle control.
- The ABS works by comparing the speed of the wheels. The tyre size affects wheel speed. When replacing tyres, all 4 tyres must use the same size, type, construction and tread pattern originally supplied with the vehicle. Using tyres of a different size can cause the ABS (Anti-lock Brake System) and ESC (Electronic Stability Control) to work irregularly.

CAUTION

When replacing the tyres, recheck and tighten the wheel nuts after driving about 50 km (31 miles) and recheck after driving about 1,000 km (620 miles). If the steering wheel shakes or the vehicle vibrates whilst driving, the tyre is out of balance. Align the tyre balance. If the problem is not solved, contact a professional workshop. Kia recommends to visit an authorised Kia dealer/service partner.

NOTICE

We recommend that when replacing tyres, use the same originally supplied with the vehicles. If not, that affects driving performance.

Wheel replacement

When replacing the metal wheels for any reason, make sure the new wheels are equivalent to the original factory units in diameter, rim width and offset.

WARNING

A wheel that is not the correct size may adversely affect wheel and bearing life, braking and stopping abilities, handling characteristics, ground clearance, body-to-tyre clearance, snow chain clearance, speedometer and odometer calibration, headlight aim and bumper height.

Tyre traction

Tyre traction can be reduced if you drive on worn tyres, tyres that are improperly inflated or on slippery road surfaces. Tyres should be replaced when tread wear indicators appear. Slow down whenever there is rain, snow or ice on the road to reduce the possibility of losing control of the vehicle.

Tyre maintenance

In addition to proper inflation, correct wheel alignment helps to decrease tyre wear. If you find a tyre is worn unevenly, have a professional workshop check the wheel alignment. Kia recommends to visit an authorised Kia dealer/service partner.

When you have new tyres installed, make sure they are balanced. This will increase vehicle ride comfort and tyre life. Additionally, a tyre should always be rebalanced if it is removed from the wheel.

Tyre sidewall labeling



This information identifies and describes the fundamental characteristics of the

tyre and also provides the tyre identification number (TIN) for safety standard certification. The TIN can be used to identify the tyre in case of a recall.

1. Manufacturer or brand name

2. Tyre size designation

A tyre's sidewall is marked with a tyre size designation. You will need this information when selecting replacement tyres for your vehicle. The following explains what the letters and numbers in the tyre size designation mean.

Example tyre size designation:

(These numbers are provided as an example only; your tyre size designator could vary depending on your vehicle.)

P235/55R19 108T

235 - Tyre width in millimetre.

55 - Aspect ratio. The tyre's section height as a percentage of its width.

R - Tyre construction code (Radial).

19 - Rim diameter in inches.

108 - Load Index, a numerical code associated with the maximum load the tyre can carry.

T - Speed Rating Symbol. See the speed rating chart in this section for additional information.

Tyre speed ratings

The chart below lists many of the different speed ratings currently being used for passenger car tyres. The speed rating is part of the tyre size designation on the sidewall of the tyre. This symbol corresponds to that tyre's designed maximum safe operating speed.

| Speed Rating Symbol | Maximum Speed |
|---------------------|--------------------|
| S | 180 km/h (112 mph) |
| T | 190 km/h (118 mph) |
| H | 210 km/h (130 mph) |
| V | 240 km/h (149 mph) |
| W | 270 km/h (168 mph) |
| Y | 300 km/h (186 mph) |

3. Checking tyre life (TIN : Tyre Identification Number)

Any tyres that are over 6 years old, based on the manufacturing date, should be replaced by new ones. You can find the manufacturing date on the tyre sidewall, displaying the DOT Code. The manufacturing date is designated by the last four digits (characters) of the DOT code.

DOT: XXXX XXXX OOOO

The front part of the DOT means a plant code number, tyre size and tread pattern and the last four numbers indicate week and year manufactured.

For example, DOT XXXX XXXX 1623 represents that the tyre was produced in the 16th week of 2023.

⚠ WARNING

Tyres degrade over time, even when they are not being used. Regardless of the remaining tread, we recommend that tyres be replaced after approximately six (6) years of normal service. Heat caused by hot climates or frequent high loading conditions can accelerate the aging process. Failure to follow this warning can result in sudden tyre failure, which could lead to a loss of control and an accident involving serious injury or death.

4. Tyre ply composition and material

The number of layers or plies of rubber-coated fabric in the tyre. Tyre manufacturers also must indicate the materials in the tyre, which include steel, nylon, polyester, and others. The letter "R" means radial ply construction; the letter "D" means diagonal or bias ply construction; and the letter "B" means belted-bias ply construction.

5. Maximum permissible inflation pressure

This number is the greatest amount of air pressure that should be put in the tyre. Do not exceed the maximum permissible inflation pressure. Refer to "Tyre specification and pressure label" on page 10-10.

6. Maximum load rating

This number indicates the maximum load in kilograms and pounds that can be carried by the tyre. When replacing the tyres on the vehicle, always use a tyre that has the same load rating as the factory installed tyre.

7. Uniform tyre quality grading

Quality grades can be found where applicable on the tyre sidewall between tread shoulder and maximum section width.

For example:

- TREADWEAR 200**
- TRACTION AA**
- TEMPERATURE A**

WARNING

- The traction grade assigned to this tyre is based on straightahead braking traction tests, and does not include acceleration, cornering, hydroplaning, or peak traction characteristics.
- The temperature grade for this tyre is established for a tyre that is properly inflated and not overloaded. Excessive speed, underinflation, or excessive loading, either separately or in combination, can cause heat build-up in tyre and sudden tyre failure. This can cause loss of vehicle control and serious injury or death.

Tread wear

The tread wear grade is a comparative rating based on the wear rate of the tyre when tested under controlled conditions on a specified government test course. For example, a tyre graded 150 would wear one-and-a-half times (1½) as well on the government course as a tyre graded 100.

The relative performance of tyres depends upon the actual conditions of their use, however, and may depart significantly from the norm due to variations in driving habits, service practices and differences in road characteristics and climate.

These grades are molded on the sidewalls of passenger vehicle tyres. The tyres available as standard or optional equipment on your vehicle may vary with respect to grade.

Traction - AA, A, B & C

The traction grades, from highest to lowest, are AA, A, B and C. Those grades

represent the tyre's ability to stop on wet pavement as measured under controlled conditions on specified government test surfaces of asphalt and concrete. A tyre marked C may have poor traction performance.

Temperature -A, B & C

The temperature grades are A (the highest), B, and C, representing the tyre's resistance to the generation of heat and its ability to dissipate heat when tested under controlled conditions on a specified indoor laboratory test wheel.

Sustained high temperature can cause the material of the tyre to degenerate and reduce tyre life, and excessive temperature can lead to sudden tyre failure. Grades B and A represent higher levels of performance on the laboratory test wheel than the minimum required by law.

Low aspect ratio tyre

Low aspect ratio tyres, whose aspect ratio is lower than 50, are provided for sporty looks.

Because the low aspect ratio tyres are optimized for handling and braking, it may be more uncomfortable to ride in and there is more noise compare with normal tyres.

CAUTION

- Because the sidewall of the low aspect ratio tyre is shorter than the normal, the wheel and tyre of the low aspect ratio tyre is easier to be damaged. So, follow the instructions below.
 - When driving on a rough road or off road, drive cautiously because tyres and wheels may be damaged. And after driving, inspect tyres and wheels.

- When passing over a pothole, speed bump, manhole, or kerb stone, drive slowly so that the tyres and wheels are not damaged.
- If the tyre is impacted, inspect the tyre condition or contact a professional workshop. Kia recommends to visit an authorised Kia dealer/ service partner.
- To prevent damage to the tyre, inspect the tyre condition and pressure every 3,000 km.
- It is not easy to recognise the tyre damage with your own eyes. But if there is the slightest hint of tyre damage, even though you cannot see the tyre damage with your own eyes, have the tyre checked or replaced because the tyre damage may cause air leakage from the tyre.
- If the tyre is damaged by driving on a rough road, off road, pothole, manhole, or kerb stone, it will not be covered by the warranty.
- You can find out the tyre information on the tyre sidewall.

Fuses

Blade type



Cartridge type



Multi fuse



BFT

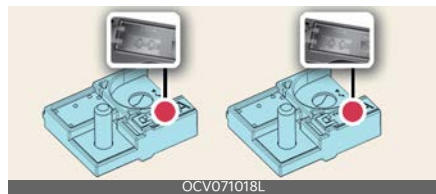

* Left: Normal, Right: Blown

* The actual fuse/relay panel label may differ.

Before replacing a blown fuse, disconnect the negative battery cable.

If the electrical system does not work, first check the driver's side fuse panel.

Always replace a blown fuse with one of the same rating.

If the replacement fuse blows, this indicates an electrical problem. Avoid using the system involved and immediately consult a professional workshop. Kia recommends to consult an authorised Kia dealer/service partner.

WARNING

- Never replace a fuse with anything but another fuse of the same rating.
- A higher capacity fuse could cause damage and possibly a fire.
- Never install a wire or aluminium foil instead of the proper fuse even as a temporary repair. It may cause extensive wiring damage and a possible fire.
- Do not arbitrarily modify or add-on electric wiring of the vehicle.
- Do not plug in screwdrivers or after-market wiring into the terminal originally designed for fuse and relays only. The electrical system and wiring of the vehicle interior may be damaged or burned due to contact failure.
- If you directly connect the wire on the taillight or replace the bulb which is over the regulated capacity to install trailers etc., the inner junction block can get burned.
- Do not use a screwdriver or any other metal object to remove fuses because it may cause a short circuit and damage the system.

CAUTION

- When replacing a blown fuse or relay with a new one, make sure the new fuse or relay fits tightly into the clips. The incomplete fastening fuse or relay may cause the vehicle wiring and electric systems damage and a possible fire.
- Do not remove fuses, relays and terminals fastened with bolts or nuts. The fuses, relays and terminals may be fastened incompletely, and it may cause a possible fire. If fuses, relays and terminals fastened with bolts or nuts are blown, consult a professional workshop. Kia recommends to consult an authorised Kia dealer/service partner.
- Do not input any other objects except fuses or relays into fuse/relay terminals such as a driver or wiring. It may cause contact failure and system malfunction.

NOTICE

- When replacing fuse, turn the ignition "OFF" and turn off switches of all electrical devices then remove battery (-) terminal.
- The actual fuse/relay panel label may differ from equipped items.
- **Window tinting precaution**
Window tint (especially metallic film) might cause communication disorder or poor radio reception, and malfunction of the automatic lighting system due to excessive change of illumination inside the vehicle. The solution used might also flow into electric, electronic devices causing disorder and failure.

Replacing inner panel fuse

Operation

1. Turn the ignition switch and all other switches off.
2. Open the fuse panel cover.



3. Pull the suspected fuse straight out. Use the removal tool provided in the main fuse box in the engine compartment.



4. Check the removed fuse; replace it if it is blown. Spare fuses are provided in the instrument panel fuse panel (or in the engine compartment fuse panel).
5. Push in a new fuse of the same rating, and make sure it fits tightly in the clips.

* INFORMATION

If the headlights or taillights, stoplights, courtesy lamp, day time running lights (DRL) do not work and the fuses are OK, consult a professional workshop. Kia recommends to consult an authorised Kia dealer/service partner.

Replacing engine compartment fuse

Operation

1. Turn the ignition switch and all other switches off.
2. Remove the fuse panel cover by pressing the tab and pulling the cover up.



When the blade type fuse is disconnected, remove it by using the clip designed for changing fuses located in the engine room fuse box. Upon removal, securely insert reserve fuse of equal quantity.

3. Check the removed fuse; replace it if it is blown. To remove or insert the fuse, use the fuse puller in the engine compartment fuse panel.
4. Push in a new fuse of the same rating, and make sure it fits tightly in the clips. If it fits loosely, consult a professional workshop. Kia recommends to consult an authorised Kia dealer/service partner.

⚠ CAUTION

After checking the fuse panel in the engine compartment, securely install the fuse panel cover through the audible clicking sound. If not, electrical failures may occur from water contact.

Replacing main fuse (multi fuse)



Operation

1. Turn off the engine.
2. Disconnect the negative battery cable.
3. Remove the nuts shown in the picture above.
4. Replace the fuse with a new one of the same rating.
5. Reinstall in the reverse order of removal.

⚠ CAUTION

Visually inspect the battery cap for secure closing. If the battery cap is not securely latched, the electrical system may be damaged to due influx of moisture into the system.

* NOTICE

- The electronic system may not function correctly even when the engine room and internal fuse box's individual fuses are not disconnected. In such case the cause of the problem may be disconnection of the main fuse (BFT type), which is located inside the positive battery terminal (+) cap. Since the main fuse is designed more intricately than other parts, visit a professional workshop. Kia recommends to visit the nearest authorised Kia dealer/service partner.
- If the multi fuse is blown, consult a professional workshop. Kia recom-

mends to consult an authorised Kia dealer/service partner.

Fuse/relay panel description

Inside the fuse/relay panel covers, you can find the fuse/relay label describing fuse/relay name and capacity.

* NOTICE

Not all fuse panel descriptions in this manual may be applicable to your vehicle. It is accurate at the time of printing. When you inspect the fuse panel in your vehicle, refer to the fuse panel label.



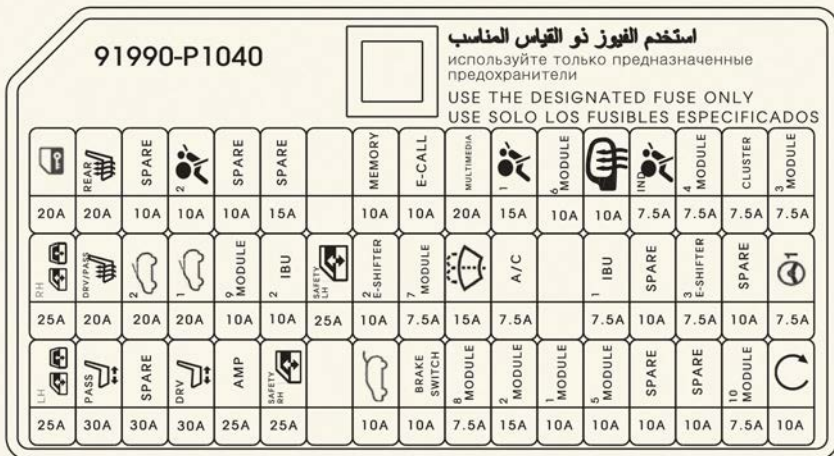







Driver's side fuse panel







ONQ5061105L

ICU Junction Block

| Fuse Name | Symbol | Fuse Rating | Circuit Protected |
|-----------------|--------|-------------|---|
| DOOR LOCK | | 20A | Centre Door Lock/Unlock Relay |
| P/WINDOW RH | | 25A | Power Window Main Switch, Passenger Power Window Switch |
| P/WINDOW LH | | 25A | Power Window Main Switch |
| S/HEATER (REAR) | | 20A | Rear Seat Warmer Control Module |

| Fuse Name | Symbol | Fuse Rating | Circuit Protected |
|-------------------------------------|---|-------------|--|
| S/HEATER (DRV/ PASS) |  | 20A | Front Air Ventilation Seat Control Module, Front Seat Warmer Control Module |
| P/SEAT (PASS) |  | 30A | Passenger Power Seat Switch |
| SUNROOF2 | ²  | 20A | Sunroof Controller (Blind Motor) |
| AIRBAG2 | ²  | 10A | SRS (Supplemental Restraint System) Control Module |
| SUNROOF1 | ¹  | 20A | Sunroof Controller (Glass Motor) |
| P/SEAT DRV |  | 30A | Driver Power Seat Switch, Driver IMS (Integrated memory system) Control Module |
| MODULE9 | ⁹ MODULE | 10A | Clutch Module Cylinder Sensor, Driver IMS (Integrated memory system) Control Module, Driver/Passenger Smart Key Outside Handle, Rain Sensor, Hazard Switch, Data Link Connector, Power Tailgate Unit, Steering Telescopic Unit |
| AMP (Amplifier) | AMP | 25A | AMP (Amplifier) |
| IBU (Integrated Body Control Unit)2 | ² IBU | 10A | IBU (Integrated Body Control Unit), Ignition Switch, Auto Transmission Lever |
| P/WINDOW SAFETY RH |  | 25A | Passenger Safety Power Window Module |
| P/WINDOW SAFETY LH |  | 25A | Driver Safety Power Window Module |
| MEMORY | MEMORY | 10A | Outside Mirror Folding/Unfolding Relay, Driver/Passenger Power Outside Mirror, Instrument Cluster, Air Conditioner Controller (LCD), Air Conditioner Control Module, Mood Lamp Unit, Mood Lamp (Passenger), Crash Pad Switch, ADAS Parking ECU |
| E-SHIFTER2 | ² E-SHIFTER | 10A | SCU (Shift by wire Control Unit), Electronic Auto Transmission Shift Lever Switch |
| TAILGATE |  | 10A | Tailgate Relay |
| E-CALL | E-CALL | 10A | Emergency Call (E-Call) Module |
| MODULE7 | ⁷ MODULE | 7.5A | IBU (Integrated Body Control Unit) |
| BRAKE SWITCH | BRAKE SWITCH | 10A | Stop Lamp Switch, IBU (Integrated Body Control Unit) |
| MULTIMEDIA | MULTI MEDIA | 20A | Audio (Display), Audio/Video & Navigation Head Unit |
| WASHER |  | 15A | Multifunction Switch |
| MODULE8 | ⁸ MODULE | 7.5A | Front Air Ventilation Seat Control Module, Front/Rear Seat Warmer Control Module, E/R Junction Block (Windscreen Heated Relay LH) |
| AIRBAG1 | ¹  | 15A | SRS (Supplemental Restraint System) Control Module |
| Air ConditionerON | A/C | 7.5A | E/R Junction Block (PTC Heater Relay #1, Blower Relay), Air Conditioner Controller (LCD), Air Conditioner Control Module |
| MODULE2 | ² MODULE | 15A | Front USB Charger Connector, Driver/Passenger Seat USB Port |
| MODULE6 | ⁶ MODULE | 10A | Console Switch, Drive Mode Switch, Data Link Connector, Auto Transmission Shift Lever Indicator |







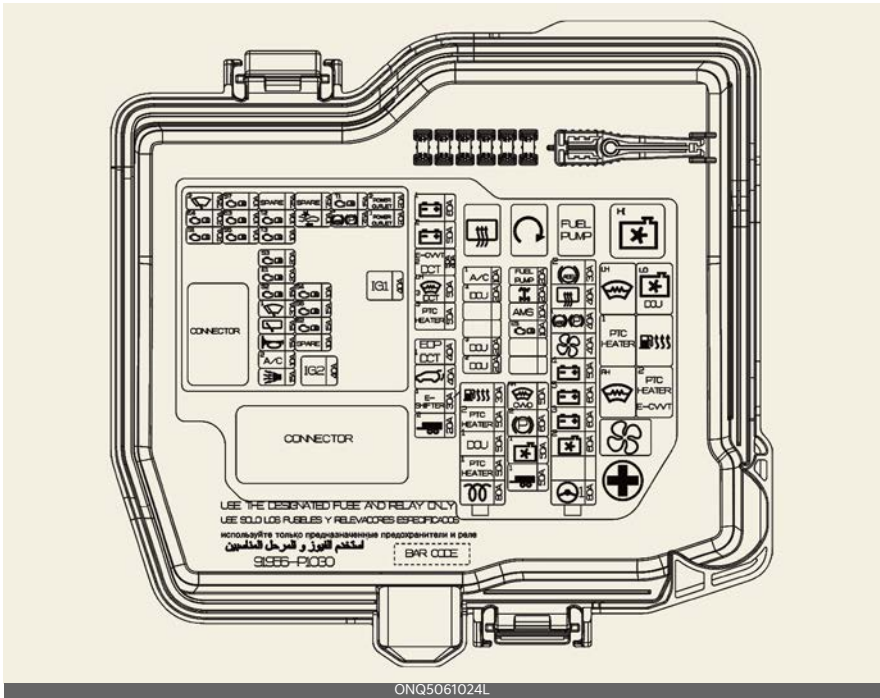







| Fuse Name | Symbol | Fuse Rating | Circuit Protected |
|---|---|-------------|---|
| MODULE1 | ¹ MODULE | 10A | ADAS Parking ECU, IBU (Integrated Body Control Unit), Audio Keyboard, Audio/Video & Navigation Keyboard, Power Outside Mirror Switch, Emergency Call (E-Call) Module, AMP (Amplifier), Audio (Display), Audio/Video & Navigation Head Unit |
| HEATED MIRROR |  | 10A | Driver/Passenger Power Outside Mirror |
| IBU (Integrated Body Control Unit) ¹ | ¹ IBU | 7.5A | IBU (Integrated Body Control Unit) |
| MODULE5 | ⁵ MODULE | 10A | Driver IMS (Integrated memory system) Control Module, Rear Seat Warmer Control Module, Front Air Ventilation Seat Control Module, AMP (Amplifier), Front Seat Warmer Control Module, Audio (Display), Audio/Video & Navigation Head Unit, Front Wireless Charger, Emergency Call (E-Call) Module, Air Conditioner Controller (LCD), Air Conditioner Control Module, Electro Chromic Mirror, |
| AIRBAG IND | ^{IND}  | 7.5A | Instrument Cluster |
| MODULE4 | ⁴ MODULE | 7.5A | IBU (Integrated Body Control Unit), Front View Camera, Crash Pad Switch, ADAS Parking ECU, Rear Corner Radar LH/RH, Clutch Module Cylinder Sensor, 4WD (4 Wheel Drive) DCU (Dosing Control unit), Head Lamp LH/RH |
| E-SHIFTER3 | ³ E-SHIFTER | 7.5A | SCU (Shift by wire Control Unit), Electronic Auto Transmission Shift Lever Switch |
| CLUSTER | CLUSTER | 7.5A | Instrument Cluster |
| MODULE3 | ³ MODULE | 7.5A | Stop Lamp Switch, Overhead Console Lamp |
| Motor Driven Power Steering ¹ |  | 7.5A | Motor Driven Power Steering Unit |
| START |  | 10A | Burglar Alarm Horn Relay, Transaxle Range Switch, Power train Control Module, IBU (Integrated Body Control Unit), Ignition Switch, E/R Junction Block (Start Relay) |
| MODULE10 | ¹⁰ MODULE | 7.5A | Diesel Fuel Filter system |











* 1: MDPS (Motor Driven Power Steering) is the same as EPS (Electric Power Steering).

Engine compartment fuse panel





















Engine Room Junction Block





| Fuse Name | Symbol | Fuse Rating | Circuit Protected |
|--|---|---|--|
| Motor Driven Power Steering ¹ |  1 | 80A | Motor Driven Power Steering Unit |
| COOLING FAN2 | 2  | 60A | Cooling Fan Controller |
| B+3 | 3  | 60A | ICU Junction Block (Fuse - S/HEATER (DRV/PASS), P/SEAT(PASS), SUNROOF2, SUNROOF1, P/SEAT DRV, AMP, P/WINDOW SAFETY RH, Power Window Main Relay) |
| B+5 | 5  | 60A | PCB Block (Fuse - IG2, IG1, HORN, A/CON2, B/ALARM HORN, ECU2, Engine Control Relay, Wiper Main Relay) |
| B+4 | 4  | 50A | ICU Junction Block (Fuse - DOOR LOCK, S/HEATER (DRV/PASS), AIRBAG2, MODULE9, IBU2, P/WINDOW SAFETY LH, E-SHIFTER2, TAILGATE, BRAKE SWITCH, Long Term Load Latch Relay) |
| MULTI FUSE-1 | BLOWER |  | 40A Blower Relay |
| ABS1/EPB1 | 1  / 1  | 40A | ESP (Electronic Stability Program Control Module) |
| REAR HEATED |  | 40A | Rear Heated Relay |
| ABS2 | 2  | 30A | ESP (Electronic Stability Program Control Module) |
| GLOW |  | 80A | GLOW Unit (Diesel) |
| PTC HEATER1 | 1  PTC HEATER | 50A | Positive Temperature Coefficient Heater1 Relay (Diesel) |
| DCU1 | 1  DCU | 50A | Dosing Control Unit Relay (Diesel) |
| PTC HEATER2 | 2  PTC HEATER | 50A | Positive Temperature Coefficient Heater2 Relay (Diesel) |
| FUEL FILTER HTR |  | 30A | Diesel Fuel Filter Relay (Diesel) |

| Fuse Name | Symbol | Fuse Rating | Circuit Protected |
|---------------------------|--|-----------------------------|--|
| TRAILER1 | ¹  | 50A | Trailer Connector |
| COOLING FAN1 | ¹  | 50A | Cooling Fan Relay High |
| EPB2 | ² (P) | 60A | ESP (Electronic Stability Program Control Module) |
| W/S HEATED GLASSRH / CVVD | RH  NG5 ER | 50A | Windscreen Heated Relay RH, Continuous Variable Valve Duration Actuator (Smartstream G1.6 T-GDi) |
| ECU5 | ^{E5}  | 10A | ECM (Engine Control Module) |
| AMS | AMS | 10A | Battery Sensor |
| 4WD |  | 20A | AWD ECM (Engine Control Module) |
| FUEL PUMP | FUEL PUMP | 20A | Fuel Pump Relay |
| Air ConditionerON1 | ¹ A/C | 10A | Blower Relay, Air Conditioner Control Module |
| TRAILER2 | ²  | 20A | Trailer Connector |
| E-SHIFTER1 | ¹ E-SHIFTER | 30A | SCU (System Control Unit) |
| TAILGATE |  | 40A | Power Tailgate Unit |
| EOP | EOP | 40A | Not Used |
| PTC HEATER3 | ³ PTC HEATER | 50A | Fuel Filter Heating Relay |
| W/S HEATED GLASSLH / DCT3 | LH  DCT NG5 ER | 50A | Windscreen Heated Relay LH, Double Clutch Transmission (Smartstream G1.6 T-GDi) |
| E-CVVT/DCT2 | ¹ E-CVVT ² DCT NG5 ER | E-CVVT (50A)/ DCT2 (40A) | Double Clutch Transmission (Smartstream G1.6 T-GDi), E-CVVT Relay (Smartstream G2.5 GDi) |
| B+2 | ²  | 50A | ICU Junction Block (IPS06/IPS07/IPS08/IPS09/IPS10/IPS11) |
| B+1 | ¹  | 60A | ICU Junction Block (IPS01/IPS02/IPS03/IPS04/IPS05) |
| DCT1 | ¹ DCT NG5 ER | 40A | Double Clutch Transmission Module |
| E-SHIFTER1 | ¹ E-SHIFTER NG5 ER E | 30A | SCU (Shift by wire Control Unit) |
| DCU2 | ² DCU | 20A | Dosing Control unit (Diesel) |
| DCU3 | ³ DCU | 20A | Dosing Control unit (Diesel) |
| DCU4 | ⁴ DCU | 20A | Dosing Control unit (Diesel) |

FUSE

PCB Block











| Fuse Name | Symbol | Fuse Rating | Circuit Protected |
|--------------------|--|-------------|--|
| IG2 | IG2 | 40A | IG2 Relay |
| IG1 | IG1 | 40A | IG1 Relay, ACC Relay |
| FR WIPER2 | ²  | 7.5A | Front Wiper (Low) Relay, ECM (Engine Control Module), IBU (Integrated Body Control Unit) |
| ECU4 | ^{E4}  | 20A | Power train Control Module |
| SENSOR1 | ^{S1}  | 20A | Ignition Coil #1~#4 |
| SENSOR7 | ^{S7}  | 10A | GLOW Unit (Diesel) |
| ECU3 | ^{E3}  | 10A | Power train Control Module |
| SENSOR5 | ^{S5}  | 10A | Fuel Pump Relay |
| TCU2 | ^{T2}  | 10A | Transmission Control Module |
| TCU3 | ^{T3}  | 10A | Transaxle Range Switch |
| SENSOR3 | ^{S3}  | 20A | ECM (Engine Control Module) |
| ECU1 | ^{E1}  | 20A | Power train Control Module |
| SENSOR2 | ^{S2}  | 15A | Oxygen Sensor (UP/DOWN) |
| FR WIPER1 | ¹  | 30A | Wiper Main Relay, Front Wiper (Low) Relay |
| RR WIPER |  | 15A | Wiper Main Relay, ICU Junction Block (Rear Wiper Relay) |
| HORN |  | 15A | Horn Relay |
| Air ConditionerON2 | ² A/C | 10A | Air Conditioner Comp Relay |
| B/ALARM HORN |  | 15A | Burglar Alarm Horn Relay |
| FCA |  | 10A | Front Radar |
| SENSOR4 | ^{S4}  | 10A | [Smartstream G2.0] Oil Control Valve #1/#2 (Intake/Exhaust), Variable Oil Pump Solenoid, Variable Intake Solenoid Valve, Purge Control Solenoid Valve, Cooling Fan Controller, Air Conditioner Comp Relay, E/R Junction Block (Cooling Fan Relay High) [Smartstream G2.5 T-GDi] Oil Control Valve #2 (Exhaust), Purge Control Solenoid Valve, Variable Oil Pump Solenoid, Variable Intake Solenoid Valve, Cooling Fan Controller, Air Conditioner Comp Relay |
| SENSOR6 | ^{S6}  | 15A | Injector #1 ~ #4 |
| ECU2 | ^{E2}  | 15A | Power train Control Module |

| Fuse Name | Symbol | Fuse Rating | Circuit Protected |
|---------------|--|-------------|--|
| TCU1 | ^{T1}  | 15A | Transmission Control Module |
| ABS3/EPB3 | ³  | 7.5A | ESP (Electronic Stability Program) (Electronic Stability Program) Control Module |
| POWER OUTLET2 | ² POWER OUTLET  | 20A | Front Power Outlet |
| POWER OUTLET1 | ¹ POWER OUTLET  | 20A | Luggage Power Outlet |

* 1: MDPS (Motor Driven Power Steering) is the same as EPS (Electric Power Steering).

Relay

Refer to the following table for the relay type.

| Relay Name | Symbol | TYPE |
|--|--|-------|
| Rear Heated Relay |  | MICRO |
| Start Relay |  | MICRO |
| Fuel Pump Relay | FUEL PUMP  | MICRO |
| Cooling Fan Relay High | ^H  | MINI |
| Windscreen Heated Relay LH | ^{LH}  | MICRO |
| Cooling Fan Relay low (Smartstream G2.0) DCU Relay (Smartstream D2.0) | ^{LD} DCU  | MICRO |
| PTC Heater Relay #1 | ¹ PTC HEATER  | MICRO |
| Fuel Filter Heating Relay |  | MICRO |
| Windscreen Heated Relay RH | ^{RH}  | MICRO |
| PTC Heater Relay #2 (Diesel) E-CVVT Relay (Smartstream G2.5 GDi) | ² PTC HEATER E-CVVT  | MICRO |
| Blower Relay |  | MICRO |

Engine compartment fuse panel (Battery terminal cover)

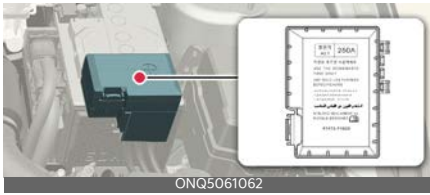

Type A



Type B



Light bulbs

Bulb replacement precautions

Turn off the engine at a safe place, firmly apply the side brake and take out the battery's negative (-) terminal. Use only the bulbs of the specified wattage.

Lamp part malfunction due to net-work failure

The headlamp, taillight, and fog light may lit up when the head lamp switch is turned ON, and not light up when the taillight or for light switch is turned ON. This may be caused by network failure or vehicle electrical control system malfunction. If there is a problem, have the system serviced by a professional workshop. Kia recommends to visit an authorised Kia dealer/service partner.

Lamp part malfunction due to electrical control system stabilization

A normally functioning lamp may flicker momentarily. This momentary occurrence is due to stabilization of the vehicle's electrical control system. If the lamp soon returns to normal, the vehicle does not require service.

However, if the lamp goes out after the momentary flickering, or the flickering continues, have the system serviced by a professional workshop. Kia recommends to visit an authorised Kia dealer/service partner.

⚠ WARNING

- Prior to working on the light, firmly apply the parking brake, ensure that the ignition switch is turned to the LOCK position and turn off the lights to avoid sudden movement of the

vehicle and burning your fingers or receiving an electric shock.

- Be sure to replace the burned out bulb with one of the same wattage rating. Otherwise, it may cause extensive wiring damage and possible fire.

⚠ CAUTION

- If you don't have necessary tools, the correct bulbs and the expertise, consult a professional workshop. Kia recommends to consult an authorised Kia dealer/service partner.
- In many cases, it is difficult to replace vehicle light bulbs because other parts of the vehicle must be removed before you can get to the bulb. This is especially true if you have to remove the headlight assembly to get to the bulb(s). Removing/installing the headlight assembly can result in damage to the vehicle. Use only Kia Genuine Parts or those of an equivalent standard part. If not, it may lead to blowing a fuse or other wiring damages.
- If unauthentic parts or substandard lights are used when changing lights, it may lead to fuse disconnection and malfunction, and other wiring damages.
- Do not install extra lamps or LED to the vehicle. If supplementary lights are installed, it may lead to lamp malfunction and flickering of the lights. In addition, the fuse box and other wiring may be damaged.

*** NOTICE**

- If the light bulb or lamp connector is removed from an operating lamp activated by electricity, the fuse box's electronic device may scan it as a

malfunction. Therefore, a lamp malfunction history may be recorded in Diagnostic Trouble Code (DTC) in the fuse box.

- It is normal for an operating lamp may blink temporarily. Since this occurrence is due stabilization function of the vehicle's electronic control device, if the lamp lights up normally after temporary blinking, there is no problem in the vehicle.

However, if the lamp continues to blink several times or turn off completely, there may be an error in the vehicle's electronic control device. In this case, have the vehicle checked by a professional workshop immediately. Kia recommends to visit an authorised Kia dealer/service partner.

- After an accident or after the headlight assembly is reinstalled, have the headlight aiming adjusted by a professional workshop. Kia recommends to visit an authorised Kia dealer/service partner.
- After driving in heavy rain or washing, headlamp and taillamp lenses could appear frosty. This condition is caused by the temperature difference between the lamp inside and outside. This is similar to the condensation on your windows inside your vehicle during the rain and doesn't indicate a problem with your vehicle. If the water leaks into the lamp bulb circuitry, have the vehicle checked by a professional workshop. Kia recommends to visit an authorised Kia dealer/service partner.

Light position (Front)

Head lamp - Type A



Head lamp - Type B



Front fog lamp



- 1 Headlamp (Low) (LED type)
- 2 Headlamp (Low/High) (LED type)
- 3 Front turn signal lamp (LED type)
- 4 Front turn signal lamp (Bulb type)
- 5 Day time running lamp/Position lamp (LED type)
- 6 Front fog lamp (LED type)

Light position (Rear)

Rear combination lamp - Type A

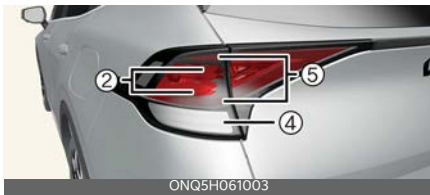

Rear combination lamp - Type B



- 1 Stop lamp (LED type)
- 2 Stop lamp (Bulb type)
- 3 Rear turn signal lamp (LED type)
- 4 Rear turn signal lamp (Bulb type)
- 5 Tail lamp (LED type)
- 6 High mounted stop lamp (LED type)
- 7 License plate lamp (Bulb type)

- 8 Backup lamp (LED type) / Rear fog lamp (LED type)
- 9 Rear fog lamp (Bulb type)

Light position (Side)



- 1 Side repeater lamp (LED type)

Replacing lights (LED type)

If the LED lamp does not operate, have your vehicle checked by a professional workshop. Kia recommends to visit an authorised Kia dealer/service partner.

The LED lamp cannot be replaced as a single unit because it is an integrated unit. The LED lamp has to be replaced with the unit.

A skilled technician should check or repair the LED lamp, for it may damage related parts of the vehicle.

Replacing front turn signal lamp (Bulb type)



Operation

1. Disconnect the negative terminal from the battery.
2. Remove the socket from the assembly by turning the socket counterclockwise until the tabs on the socket align with the slots on the assembly.

3. Remove the bulb from the socket by pressing it in and rotating it counterclockwise until the tabs on the bulb align with the slots in the socket. Pull the bulb out of the socket.
4. Insert a new bulb by inserting it into the socket and rotating it until it locks into place.
5. Install the socket in the assembly by aligning the tabs on the socket with the slots in the assembly. Push the socket into the assembly and turn the socket clockwise.
6. Connect the negative terminal from the battery.

Replacing front fog lamp (Bulb type)



Operation

1. Turn off vehicle and disconnect the negative terminal from the battery.
2. Remove the bumper.
3. Loosen the light assembly retaining screws with a cross-tip screw driver.
4. Disconnect the front fog lamp connector.
5. Remove the socket from the assembly by turning the socket counterclockwise until the tabs on the socket align with the slots on the assembly.
6. Insert a new bulb by inserting it into the socket and rotating it until it locks into place.
7. Install the light assembly in the reverse order of removal.

Replacing rear turn signal lamp, stop lamp (Bulb type)



Operation

1. Open the tailgate.
 2. Open the service cover.
 3. Loosen the light assembly retaining screws with a cross-tip screw driver.
 4. Remove the rear combination lamp assembly from the body of the vehicle.
 5. Disconnect the rear combination lamp connector.
 6. Remove the socket from the assembly by turning the socket counterclockwise until the tabs on the socket align with the slots on the assembly.
-
- 1) Stop lamp bulb
 - 2) Rear turn signal lamp bulb
7. Remove the bulb from the socket by pressing it in and rotating it counterclockwise until the tabs on the bulb align with the slots in the socket. Pull the bulb out of the socket.
 8. Insert a new bulb by inserting it into the socket and rotating it until it locks into place.

9. Install the socket in the assembly by aligning the tabs on the socket with the slots in the assembly. Push the socket into the assembly and turn the socket clockwise.
10. Install the rear combination lamp assembly to the body of the vehicle.
11. Install the service cover.

Replacing rear fog lamp (Bulb type)



Operation

1. Turn off vehicle and disconnect the negative terminal from the battery.
2. Remove the bumper.
3. Loosen the light assembly retaining screws with a cross-tip screw driver.
4. Disconnect the rear fog lamp connector.
5. Remove the socket from the assembly by turning the socket counterclockwise until the tabs on the socket align with the slots on the assembly.
6. Insert a new bulb by inserting it into the socket and rotating it until it locks into place.
7. Install the light assembly in the reverse order of removal.

Replacing license plate lamp (Bulb type)



Operation

1. Turn off vehicle and disconnect the negative terminal from the battery.
2. Using a screwdriver, gently pry the lamp assembly.
3. Remove the bulb by pulling it straight out.
4. Install a new bulb in the socket.
5. Install the lamp assembly.

⚠ CAUTION

Be careful not to dirty or damage the lens, lens tab, and plastic housings.

Replacing map lamp (Bulb type)



Operation

1. Using a flat-blade screwdriver, gently pry the lens cover from lamp housing.
2. Remove the bulb by pulling it straight out.
3. Install a new bulb in the socket.
4. Align the lens cover tabs with the lamp housing notches and snap the lens into place.

⚠ WARNING

Prior to working on the Interior lamps, ensure that the "OFF" button is depressed to avoid burning your fingers or receiving an electric shock.

Replacing room lamp (Bulb type)**Operation**

1. Using a flat-blade screwdriver, gently pry the lens cover from lamp housing.
2. Remove the bulb by pulling it straight out.
3. Install a new bulb in the socket.
4. Align the lens cover tabs with the lamp housing notches and snap the lens into place.

⚠ WARNING

Prior to working on the Interior lamps, ensure that the "OFF" button is depressed to avoid burning your fingers or receiving an electric shock.

Replacing vanity mirror lamp (Bulb type)**Operation**

1. Using a flat-blade screwdriver, gently pry the lens cover from lamp housing.
2. Remove the bulb by pulling it straight out.
3. Install a new bulb in the socket.
4. Align the lens cover tabs with the lamp housing notches and snap the lens into place.

⚠ WARNING

Prior to working on the Interior lamps, ensure that the "OFF" button is depressed to avoid burning your fingers or receiving an electric shock.

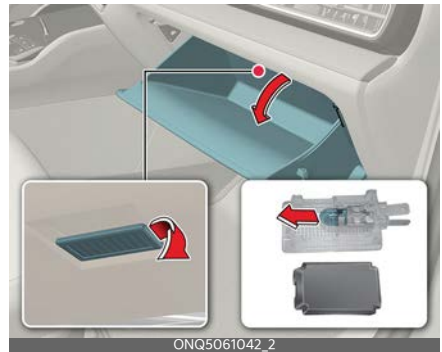
Replacing glove box lamp (Bulb type)

Operation

1. Using a flat-blade screwdriver, gently pry the lamp assembly from interior.
2. Remove the cover from the lamp assembly.
3. Remove the bulb by pulling it straight out.
4. Install a new bulb in the socket.
5. Install the cover to the lamp assembly.
6. Install the lamp assembly to interior.

⚠ WARNING

Prior to working on the Interior lamps, ensure that the "OFF" button is depressed to avoid burning your fingers or receiving an electric shock.

Replacing luggage lamp (Bulb type)



Operation

1. Using a flat-blade screwdriver, gently pry the lens cover from lamp housing.
2. Remove the bulb by pulling it straight out.
3. Install a new bulb in the socket.
4. Align the lens cover tabs with the lamp housing notches and snap the lens into place.

⚠ WARNING

Prior to working on the Interior lamps, ensure that the "OFF" button is

depressed to avoid burning your fingers or receiving an electric shock.

Headlamp and front fog lamp aiming (for Europe)

Headlamp aiming

Type A

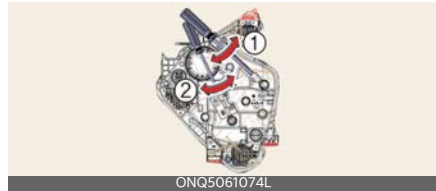

Type B



Operation

- Inflate the tyres to the specified pressure and remove any loads from the vehicle except the driver, spare tyre, and tools.
- The vehicle should be placed on a flat floor.
- Draw vertical lines (Vertical lines passing through respective head lamp centres) and a horizontal line (Horizontal line passing through centre of head lamps) on the screen.
- With the head lamp and battery in normal condition, aim the head lamps so the brightest portion falls on the horizontal and vertical lines.
- To aim the low beam left or right, turn the screwdriver (1) clockwise or counterclockwise. To aim the low beam up

or down, turn the screwdriver (2) clockwise or counterclockwise.

Front fog lamp aiming

Type A



Type B



The front fog lamp can be aimed in the same manner as the head lamps. With the front fog lamps and battery in normal condition, aim the front fog lamps.

Operation

- Turn the screwdriver clockwise or counterclockwise to aim the front fog lamp up or down.

Aiming point

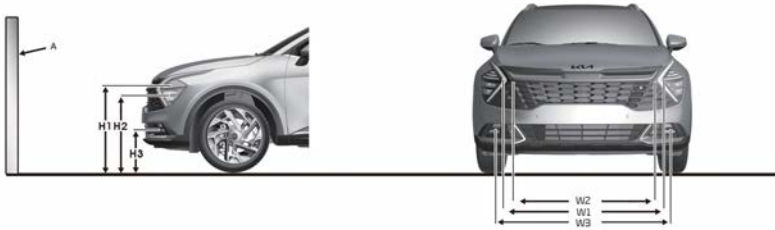

ONQ5061086L

A: Screen

| Vehicle condition | | Head lamp (LED type) | | | | Front Fog lamp (LED type) (if equipped) | |
|-----------------------------|--------|----------------------|-----------------|------------------------|-----------------|---|------------------------|
| | | Ground Height | | Distance between lamps | | Ground Height | Distance between lamps |
| | | Low/High beam | | Low/High beam | | | |
| | | H1 | H2 | W1 | W2 | H3 | W3 |
| without driver [mm (in)] | Type A | 764.1 (30.1) | 713.6 (28.1) | 1,532 (60.3) | 1,546 (60.9) | 427 (16.8) | 1,380 (54.3) |
| | Type B | 764.1 (30.1) | 713.6 (28.1) | 1,532 (60.3) | 1,546 (60.9) | 402 (15.8) | 1,157 (45.6) |
| with driver [mm (in)] | Type A | 754.1 (29.7) | 703.6 (27.7) | 1,532 (60.3) | 1,546 (60.9) | 417 (16.4) | 1,380 (54.3) |
| | Type B | 754.1 (29.7) | 703.6 (27.7) | 1,532 (60.3) | 1,546 (60.9) | 392 (15.4) | 1,157 (45.6) |

Head lamp low beam (LHD Vehicle)

Based on 10m screen

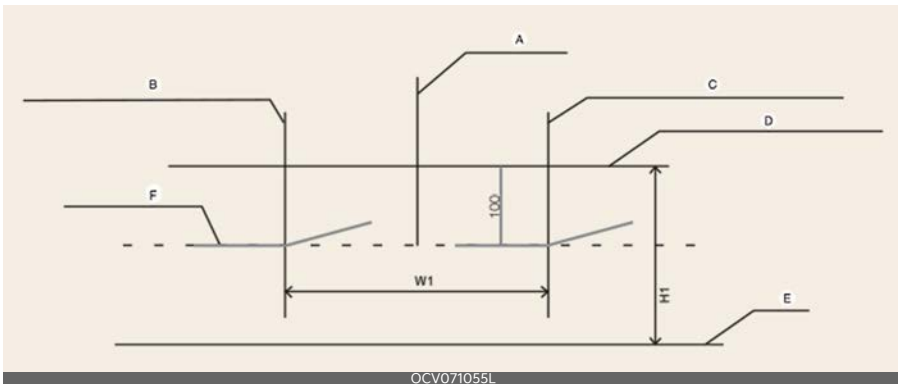

OCV071055L

- A: Vehicle axis
- B: Vertical line of the left head lamp bulb centre
- C: Vertical line of the right head lamp bulb centre
- D: Horizontal line of head lamp bulb centre
- E: Ground
- F: Cut-Off line

Operation

1. Turn the low beam on without driver aboard.
2. The cut-off line should be projected in the cut-off line shown in the picture.
3. When aiming the low beam, vertical aiming should be adjusted after adjusting the horizontal aiming.
4. If head lamp levelling device is equipped, adjust the head lamp levelling device switch with 0 positions.

Head lamp low beam (RHD Vehicle)

Based on 10m screen

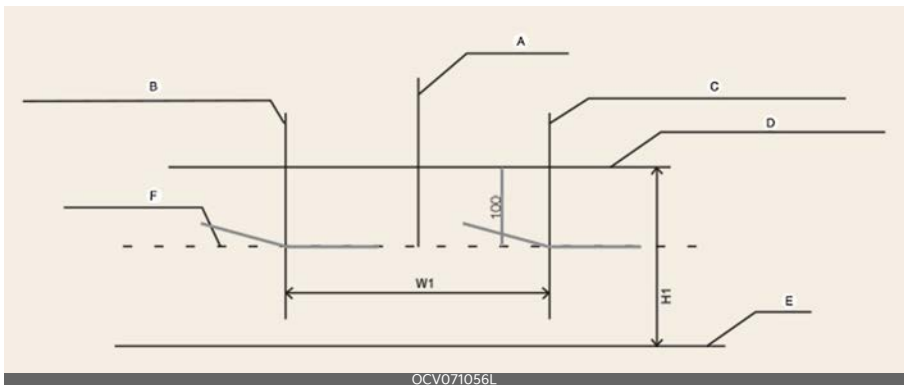

- A: Vehicle axis
- B: Vertical line of the left head lamp bulb centre
- C: Vertical line of the right head lamp bulb centre
- D: Horizontal line of head lamp bulb centre
- E: Ground
- F: Cut-Off line

Operation

1. Turn the low beam on without driver aboard.
2. The cut-off line should be projected in the cut-off line shown in the picture.

3. When aiming the low beam, vertical aiming should be adjusted after adjusting the horizontal aiming.
4. If head lamp levelling device is equipped, adjust the head lamp levelling device switch with 0 positions.

Front fog lamp

Based on 10m screen

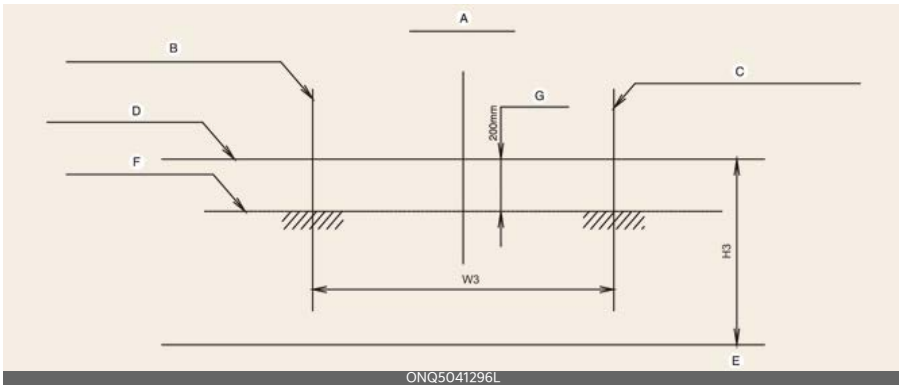

- A: Vehicle axis
- B: Vertical line of the left fog lamp bulb centre
- C: Vertical line of the right fog lamp bulb centre
- D: Horizontal line of fog lamp bulb centre
- E: Ground
- F: Cut-Off line
- G: Upper limit

Operation

1. Turn the front fog lamp on without the driver aboard.
2. The cut-off line should be projected in the allowable range (shaded region).

Appearance care

Exterior care

Exterior general caution

It is very important to follow the label directions when using any chemical cleaner or polish. Read all warning and caution statements that appear on the label.

* NOTICE

If you park the vehicle around a stainless signboard or windscreen building etc., the plastic exterior trim (bumper, spoiler, garnish, lamp, outside mirror etc.) may be damaged by reflected sunlight from the external structure. To avoid damaging the plastic exterior trim, park the vehicle away from the areas where the reflected light may occur or use a vehicle cover. (Depending on the vehicle, the type of exterior trim applied such as spoiler may differ.)

Finish maintenance

Washing

To help protect your vehicle's finish from rust and deterioration, wash it thoroughly and frequently at least once a month with lukewarm or cold water.

If you use your vehicle for off-road driving, you should wash it after each off-road trip. Pay special attention to the removal of any accumulation of salt, dirt, mud, and other foreign materials. Make sure the drain holes in the lower edges of the doors and rocker panels are kept clear and clean. Insects, tar, tree sap, bird droppings, industrial pollution and

similar deposits can damage your vehicle's finish if not removed immediately. Even prompt washing with plain water may not completely remove all these deposits. A mild soap, safe for use on painted surfaces, may be used. After washing, rinse the vehicle thoroughly with lukewarm or cold water. Do not allow soap to dry on the finish.

⚠ WARNING

After washing the vehicle, test the brakes whilst driving slowly to see if they have been affected by water. If braking performance is impaired, dry the brakes by applying them lightly whilst maintaining a slow forward speed.

⚠ CAUTION

- Do not use strong soap, chemical detergents or hot water, and do not wash the vehicle in direct sunlight or when the body of the vehicle is warm.
- Be careful when washing the side windows and other gaps (between door and body structure, side windows and exterior) of your vehicle. Especially, with high-pressure water, water may leak through the windows and wet the interior.
- To prevent damage to the plastic parts and lamps, do not clean with chemical solvents or strong detergents.

High-pressure washing



- When using high-pressure washers, make sure to maintain sufficient distance from the vehicle. Insufficient clearance or excessive pressure can lead to component damage or water penetration.
- Do not spray the camera, sensors or its surrounding area directly with a high pressure washer. Shock applied from high pressure water may cause the device to not operate normally.
- Do not bring the nozzle tip close to boots (rubber including weather strips or plastic covers) or connectors as they may be damaged if they come into contact with high pressure water.

⚠ CAUTION

- Water washing in the engine compartment including high pressure water washing may cause the failure of electrical circuits located in the engine compartment.
- Never allow water or other liquids to come in contact with electrical/electronic components inside the vehicle as this may damage them.

* NOTICE

Matte paint finish vehicle (if equipped)

Automatic car wash which uses rotating brushes should not be used as this can damage the surface of your vehicle. A steam cleaner which washes the vehicle surface at high temperature may result the oil to adhere and leave stains that is difficult to remove.

Use a soft cloth (e.g. microfiber towel or sponge) when washing your vehicle and dry with a microfiber towel. When you hand wash your vehicle, you should not use a cleaner that finishes with wax. If

the vehicle surface is too dirty (sand, dirt, dust, contaminant, etc.), clean the surface with water before washing the car.

Waxing

Wax the vehicle when water will no longer bead on the paint.

Always wash and dry the vehicle before waxing. Use a good quality liquid or paste wax, and follow the manufacturer's instructions. Wax all metal trim to protect it and to maintain its luster.

Removing oil, tar, and similar materials with a spot remover will usually strip the wax from the finish. Be sure to re-wax these areas even if the rest of the vehicle does not yet need waxing. Do not apply wax on embossed unpainted unit, as it may tarnish the unit.

⚠ CAUTION

- Wiping dust or dirt off the body with a dry cloth will scratch the finish.
- Do not use steel wool, abrasive cleaners, acid detergents or strong detergents containing high alkaline or caustic agents on chrome-plated or anodized aluminium parts. This may result in damage to the protective coating and cause discoloration or paint deterioration.

* NOTICE

- **Matte paint finish vehicle (if equipped)**

Do not use any polish protector such as a detergent, an abrasive and a polish. In case wax is applied, remove the wax immediately using a silicon remover and if any tar or tar contaminant is on the surface use a tar

remover to clean. However, be careful not to apply too much pressure on the painted area.

Finish damage repair

Deep scratches or stone chips in the painted surface must be repaired promptly. Exposed metal will quickly rust and may develop into a major repair expense.

* NOTICE

- If your vehicle is damaged and requires any metal repair or replacement, be sure the body shop applies anti-corrosion materials to the parts repaired or replaced.
- **Matte paint finish vehicle (if equipped)**

In case of matte paint finish vehicles, it is impossible to modify only the damaged area and repair of the whole part is necessary. If the vehicle is damaged and painting is required, we recommend that you have your vehicle maintained and repaired by an authorised Kia dealer/service partner. Take extreme care, as it is difficult to restore the quality after the repair.

Bright-metal maintenance

- To remove road tar and insects, use a tar remover, not a scraper or other sharp object.
- To protect the surfaces of bright metal parts from corrosion, apply a coating of wax or chrome preservative and rub to a high luster.
- During winter weather or in coastal areas, cover the bright metal parts with a heavier coating of wax or pre-

servative. If necessary, coat the parts with non-corrosive petroleum jelly or other protective compound.

Underbody maintenance

Corrosive materials used for ice and snow removal and dust control may collect on the underbody. If these materials are not removed, accelerated rusting can occur on underbody parts such as the fuel lines, frame, floor pan and exhaust system, even though they have been treated with rust protection.

Thoroughly flush the vehicle underbody and wheel openings with lukewarm or cold water once a month, after off-road driving and at the end of each winter. Pay special attention to these areas because it is difficult to see all the mud and dirt. It will do more harm than good to wet down the road grime without removing it. The lower edges of the doors, rocker panels, and frame members have drain holes that should not clog with dirt; trapped water in these areas can cause rusting.

⚠ WARNING

After washing the vehicle, test the brakes whilst driving slowly to see if they have been affected by water. If braking performance is impaired, dry the brakes by applying them lightly whilst maintaining a slow forward speed.

Aluminium wheel maintenance

The aluminium wheels are coated with a clear protective finish.

- Do not use any abrasive cleaner, polishing compound, solvent, or wire brushes on aluminium wheels. They may scratch or damage the finish.

- Clean the wheel when it has cooled.
- Use only a mild soap or neutral detergent, and rinse thoroughly with water. Also, be sure to clean the wheels after driving on salted roads. This helps prevent corrosion.
- Avoid washing the wheels with high-speed car wash brushes.
- Do not use any alkaline or acid detergent. It may damage and corrode the aluminium wheels coated with a clear protective finish.

Corrosion protection

Protecting your vehicle from corrosion

By using the most advanced design and construction practices to combat corrosion, we produce vehicles of the highest quality. However, this is only part of the job. To achieve the longterm corrosion resistance your vehicle can deliver, the owner's cooperation and assistance is also required.

Common causes of corrosion

The most common causes of corrosion on your vehicle are:

- Road salt, dirt and moisture that is allowed to accumulate underneath the vehicle.
- Removal of paint or protective coatings by stones, gravel, abrasion or minor scrapes and dents which leave unprotected metal exposed to corrosion.

High-corrosion areas

If you live in an area where your vehicle is regularly exposed to corrosive materials, corrosion protection is particularly

important. Some of the common causes of accelerated corrosion are road salts, dust control chemicals, ocean air and industrial pollution.

Moisture breeds corrosion

Moisture creates the conditions in which corrosion is most likely to occur. For example, corrosion is accelerated by high humidity, particularly when temperatures are just above freezing. In such conditions, the corrosive material is kept in contact with the vehicle's surface by moisture that evaporate slowly. Mud is particularly corrosive because it dries slowly and holds moisture in contact with the vehicle. Although the mud appears to be dry, it can still retain moisture and promote corrosion. High temperatures can also accelerate corrosion of parts that are not properly ventilated so the moisture can be dispersed.

For all these reasons, it is particularly important to keep your vehicle clean and free of mud or accumulations of other materials. This applies not only to the visible surfaces but particularly to the underside of the vehicle.

To help prevent corrosion

You can help prevent corrosion from getting started by observing the following:

Keep your vehicle clean

The best way to prevent corrosion is to keep your vehicle clean and free of corrosive materials. Attention to the underside of the vehicle is particularly important.

- If you live in a high-corrosion area - where road salts are used, near the ocean, areas with industrial pollution,

acid rain, etc., you should take extra care to prevent corrosion. In winter, hose off the underside of your vehicle at least once a month and be sure to clean the underside thoroughly when winter is over.

- When cleaning underneath the vehicle, give particular attention to the components under the fenders and other areas that are hidden from view. Do a thorough job; just dampening the accumulated mud rather than washing it away will accelerate corrosion rather than prevent it. Water under high pressure and steam are particularly effective in removing accumulated mud and corrosive materials.
- When cleaning lower door panels, rocker panels and frame members, be sure that drain holes are kept open so that moisture can escape and not be trapped inside to accelerate corrosion.

Keep your garage dry

Don't park your vehicle in a damp, poorly ventilated garage. This creates a favorable environment for corrosion. This is particularly true if you wash your vehicle in the garage or drive it into the garage when it is still wet or covered with snow, ice or mud. Even a heated garage can contribute to corrosion unless it is well ventilated so moisture is dispersed.

Keep paint and trim in good condition

Scratches or chips in the finish should be covered with "touch-up" paint as soon as possible to reduce the possibility of corrosion. If bare metal is showing through,

the attention of a qualified body and paint shop is recommended.

Bird droppings: Bird droppings are highly corrosive and may damage painted surfaces in just a few hours. Always remove bird droppings as soon as possible.

Don't neglect the interior

Moisture can collect under the floor mats and carpeting and cause corrosion. Check under the mats periodically to be sure the carpeting is dry. Use particular care if you carry fertilizers, cleaning materials or chemicals in the vehicle. These should be carried only in proper containers and any spills or leaks should be cleaned up, flushed with clean water and thoroughly dried.

Interior care

Interior general precautions

Prevent chemicals such as perfume, cosmetic oil, sun cream, hand cleaner, and air freshener from contacting the interior parts because they may cause damage or discoloration. If they do contact the interior parts, wipe them off immediately. If necessary, use a mixture of warm water and mild non-detergent cleaner (test all cleaners on a concealed area before use). Use proper car cleaner to clean interior parts.

CAUTION

- Never allow water or other liquids to come in contact with electrical/electronic components inside the vehicle as this may damage them.
- When cleaning leather products (steering wheel, seats etc.), use neutral detergents or low alcohol content

solutions. If you use high alcohol content solutions or acid/alkaline detergents, the colour of the leather may fade or the surface may get stripped off.

Taking care of leather seats (if equipped)

- Vacuum the seat periodically to remove dust and sand on the seat. It will prevent abrasion or damage of the leather and maintain its quality.
- Wipe the leather seat cover often with dry or soft cloth.
- Sufficient use of a leather protective may prevent abrasion of the cover and helps maintain the colour. Be sure to read the instructions and consult a specialist when using leather coating or protective agents.
- Leather with bright colours (beige, cream beige) is easily contaminated and clear in appearance. Clean the seats frequently.
- Avoid wiping with wet cloth. It may cause the surface to crack.

Cleaning the leather seats (if equipped)

- Remove all contaminations instantly. Refer to instructions below for removal of each contaminant.
- Cosmetic products (sunscreen, foundation, etc.)
 - Apply cleansing cream on a cloth and wipe the contaminated point. Wipe off the cream with a wet cloth and remove water with a dry cloth.
- Beverages (coffee, soft drink, etc.)

- Apply a small amount of neutral detergent and wipe until contaminations do not smear.
- Oil
 - Remove oil instantly with absorbable cloth and wipe with stain remover for leather only.
- Chewing gum
 - Harden the gum with ice and remove gradually.

Fabric seat cover using precautions (if equipped)

Please clean the fabric seats regularly with a vacuum cleaner in consideration of fabric material characteristics. If they are heavily soiled with beverage stains, etc., use a suitable interior cleaner. To prevent damage to seat covers, wipe off the seat covers down to the seams with a large wiping motion and moderate pressure using a soft sponge or microfiber cloth.

Velcro closures on clothing or sharp objects may cause snagging or scratches on the surface of the seats. Make sure not to rub such objects against the surface.

Cleaning the upholstery and interior trim

Car interior surfaces

Remove dust and loose dirt from interior surfaces with a whisk broom or a vacuum cleaner. If necessary, clean interior surfaces with a mixture of warm water and mild non-detergent cleaner (test all cleaners on a concealed area before use).

Fabric

Remove dust and loose dirt from fabric with a whisk broom or vacuum cleaner. Clean with a mild soap solution recommended for upholstery or carpets. Remove fresh spots immediately with a fabric spot cleaner. If fresh spots do not receive immediate attention, the fabric can be stained and its colour can be affected. Also, its fire-resistant properties can be reduced if the material is not properly maintained.

CAUTION

Using anything but recommended cleaners and procedures may affect the fabric's appearance and fire-resistant properties.

Cleaning the lap/shoulder belt webbing

Clean the belt webbing with any mild soap solution recommended for cleaning upholstery or carpet. Follow the instructions provided with the soap. Do not bleach or re-dye the webbing because this may weaken it.

Cleaning the interior window glass

If the interior glass surfaces of the vehicle become fogged (that is, covered with an oily, greasy or waxy film), they should be cleaned with a glass cleaner. Follow the directions on the glass cleaner container.

CAUTION

Do not scrape or scratch the inside of the rear window. This may result in damage of the rear window defroster grid.

Emission control system (if equipped)

The emission control system of your vehicle is covered by a written limited warranty. Please see the warranty information contained in the Warranty & Maintenance book in your vehicle.

Your vehicle is equipped with an emission control system to meet all applicable emission regulations.

There are three emission control systems, as follows.

1. Crankcase emission control system
2. Evaporative emission control system
3. Exhaust emission control system

In order to assure the proper function of the emission control systems, have your vehicle inspected and maintained by a professional workshop in accordance with the maintenance schedule in this manual. Kia recommends to visit an authorised Kia dealer/service partner.

Caution for the Inspection and Maintenance Test (With Electronic Stability Control (ESC) system)

- To prevent the vehicle from misfiring during dynamometer testing, turn the Electronic Stability Control (ESC) system off by pressing the ESC switch.
- After dynamometer testing is completed, turn the ESC system back on by pressing the ESC switch again.

1. Crankcase emission control system

The positive crankcase ventilation system is employed to prevent air pollution caused by blow-by gases being emitted from the crankcase. This system supplies fresh filtered air to the crankcase through the air intake hose. Inside the

crankcase, the fresh air mixes with blow-by gases, which then pass through the PCV valve into the induction system.

2. Evaporative emission control system

The Evaporative Emission Control System is designed to prevent fuel vapours from escaping into the atmosphere.

Canister

Fuel vapours generated inside the fuel tank are absorbed and stored in the onboard canister. When the engine is running, the fuel vapours absorbed in the canister are drawn into the surge tank through the purge control solenoid valve.

Purge Control Solenoid Valve (PCSV)

The purge control solenoid valve is controlled by the Engine Control Module (ECM); when the engine coolant temperature is low during idling, the PCSV closes so that evaporated fuel is not taken into the engine. After the engine warms up during ordinary driving, the PCSV opens to introduce evaporated fuel to the engine.

3. Exhaust emission control system

The Exhaust Emission Control System is a highly effective system which controls exhaust emissions whilst maintaining good vehicle performance.

Engine exhaust gas precautions (carbon monoxide)

- Carbon monoxide can be present with other exhaust fumes. Therefore, if you

smell exhaust fumes of any kind inside your vehicle, have it inspected and repaired immediately. If you ever suspect exhaust fumes are coming into your vehicle, drive it only with all the windows fully open. Have your vehicle checked and repaired immediately.

- Do not operate the engine in confined or closed areas (such as garages) any more than what is necessary to move the vehicle in or out of the area.
- When the vehicle is stopped in an open area for more than a short time with the engine running, adjust the ventilation system (as needed) to draw outside air into the vehicle.
- Never sit in a parked or stopped vehicle for any extended time with the engine running.
- When the engine stalls or fails to start, excessive attempts to restart the engine may cause damage to the emission control system.

WARNING

Engine exhaust gases contain carbon monoxide (CO). Though colourless and odourless, it is dangerous and could be lethal if inhaled. Follow the instructions on this page to avoid CO poisoning.

Operating precautions for catalytic converters

Your vehicle is equipped with a catalytic converter emission control device.

Therefore, the following precautions must be observed:

- Make sure to refuel your vehicle according to the "Fuel requirements" on page 1-2.

- Do not operate the vehicle when there are signs of engine malfunction, such as misfire or a noticeable loss of performance.
- Do not misuse or abuse the engine. Examples of misuse are coasting with the ignition off and descending steep grades in gear with the ignition off.
- Do not operate the engine at high idle speed for extended periods (5 minutes or more).
- Do not modify or tamper with any part of the engine or emission control system. All inspections and adjustments must be made by a professional workshop. Kia recommends to visit an authorised Kia dealer/service centre.
- Avoid driving with an extremely low fuel level. Running out of fuel could cause the engine to misfire, damaging the catalytic converter.

Failure to observe these precautions could result in damage to the catalytic converter and to your vehicle. Additionally, such actions could void your warranties.

WARNING

- A hot exhaust system can ignite flammable items under your vehicle. Do not park the vehicle over or near flammable objects, such as grass, vegetation, paper, leaves, etc.
- The exhaust system and catalytic system are very hot whilst the engine is running or immediately after the engine is turned off. Keep away from the exhaust system and catalytic, you may get burned.

Also, do not remove the heat sink around the exhaust system, do not seal the bottom of the vehicle or do

not coat the vehicle for corrosion control. It may present a fire risk under certain conditions.

Petrol Particulate Filter (if equipped)

The Petrol Particulate Filter (PPF) is the system that removes the soot from the exhaust gas. Unlike a disposable air filter, the PPF system automatically burns (oxidizes) and removes the accumulated soot whilst driving.

However, repeated short-distance driving or long-distance driving at a low speed can stop the accumulated soot from automatically being removed by the PPF system. If the accumulated soot reaches a certain amount, the PPF warning light () will appear. To re-operate the PPF system, the vehicle should be driven for more than 30 minutes at a speed of 80 km/h and faster. Ensure the following conditions are met: safe road conditions, transmission 3 or above, and engine speed of 1,500-4,000 rpm. Driving at 80 km/h or faster for recommended hours will get the PPF system back to work and stop the PPF warning light.

If the PPF warning light stays on or the warning message "check exhaust system" pops up even after driving at recommended speed and for recommended hours, visit a professional workshop and have them check the PPF system. Constant driving with the PPF warning light on can damage the PPF system and undermine fuel economy.

Diesel particulate filter (if equipped)

The Diesel Particulate Filter (DPF) system removes the soot in the exhaust gas.

Unlike a disposable air filter, the DPF system automatically burns (oxidizes) and removes the accumulated soot according to the driving condition. In other words, the active burning by engine control system and high exhaust gas temperature caused by normal/high driving condition burns and removes the accumulated soot. However, if the vehicle continues to be driven at repeated short distance or driven at low speed for a long time, the accumulated soot may not be automatically removed because of low exhaust gas temperature. More than a certain amount of soot deposited, the malfunction indicator light () will appear, and "Keep driving to regenerate exhaust filter" will be displayed on the cluster.

When the malfunction indicator light blinks, it may stop blinking by driving the vehicle at more than 60 km/h (37 mph) or at more than second gear with 1250 ~ 2500 engine rpm for a certain time (for about 25 minutes).

If the malfunction indicator light () continues to be blinked or the warning message "Check exhaust system" appears in spite of the procedure, visit a professional workshop and check the DPF system. Kia recommends to visit an authorised Kia dealer/service partner. If you continue to drive with the malfunction indicator light blinking for a long time, the DPF system can be damaged and fuel consumption can be worsen and engine durability can be worsen by oil dilution.

CAUTION

It is recommended to use the regulated automotive diesel fuel for diesel vehicle equipped with the DPF system.

If you use diesel fuel including high sulfur (more than 50 ppm sulfur) and unspecified additives, it can cause the DPF system to be damaged and white smoke can be emitted.

Lean NOx Trap

The Lean NOx Trap (LNT) system removes the nitrogen oxide in the exhaust gas. The smell can occur in the exhaust gas depending on the quality of the fuel and it can degrade NOx reduction performance, please use the regulated automotive diesel fuel.

Selective Catalytic Reduction (if equipped)

The Selective Catalytic Reduction (SCR) system is to catalytically convert NOx to Nitrogen and Water by using the reduction agent, the urea solution.

WARNING

- It may be a criminal offence to use a vehicle that does not consume any urea solution.
- Use of, and refilling of, a required urea solution of the correct specifications is mandatory for the vehicle to comply with the certificate of conformity issued for that vehicle type.

Urea solution level gauge



A: Urea Level

The urea solution level gauge indicates the approximate amount of remaining urea solution inside the urea solution tank.

* The urea level gauge image pops up, whenever the ENGINE START/STOP button is ON position.

Low urea solution warning message



A: Low Urea





A: Refill Urea



A: Refill urea in 000km or vehicle will not start



A: Refill urea tank or vehicle will not start

The lack warning messages of urea solution appear below urea solution level of approximately 5.4 L. When the warning message "Low Urea" is displayed with SCR warning lamp (), the urea solution tank needs to be refilled. If not refilled for a considerable mileage, visual warning system will escalate the intensity by displaying the message "Refill Urea" with SCR warning lamp ().





In this case, the urea solution tank soon needs to be refilled. The remaining urea solution in the urea solution tank approaches to too low level the warning message "Refill Urea in 000 km or vehicle will not start" with SCR warning lamp (). "xxx km(mile)" represents the remaining travel distance allowed, so do not continue driving to the limit of the remaining travel distance without refilling.

Otherwise, the vehicle can't be restarted once the engine is turned off by the ENGINE START/STOP button. Based on the driving pattern, environmental condition and road profile, the deducted remaining mileage may differ from the actual travel distance. When "Low Urea" or "Refill Urea" message is displayed, a sufficient amount of urea solution must be added. When "Refill Urea in 000 km or vehicle will not start" message is displayed, refill a sufficient amount of urea solution.

When "Refill Urea tank or vehicle will not start" message is displayed with SCR warning lamp (), the vehicle can't be restarted once the engine is turned off by the ENGINE START/STOP button. For the above cases, full replenishment is always recommended.

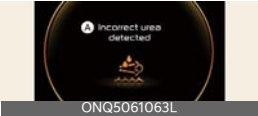
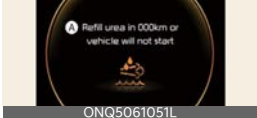
Refer to "Recommended lubricants and capacities" on page 10-7.

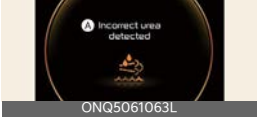

Malfunction with the SCR system

| | Upon detecting a malfunction | Driving 50 km after detecting a malfunction |
|--|--|---|
| Urea solution system failure (= no urea solution injection) |  <p>ONQ5061063L</p> <p>A: Incorrect urea detected</p> |  <p>ONQ5061051L</p> <p>A: Refill with correct urea in 000km or vehicle will not start</p> |
| Incorrect urea solution detected (= abnormal urea solution) |  <p>ONQ5061063L</p> <p>A: Incorrect urea detected</p> |  <p>ONQ5061064L</p> <p>A: Refill with correct urea in 000km or vehicle will not start</p> |
| Abnormal urea-solution consumption (= post treatment failure) |  <p>ONQ5061063L</p> <p>A: Incorrect urea detected</p> |  <p>ONQ5061064L</p> <p>A: Refill with correct urea in 000km or vehicle will not start</p> |

SCR system has malfunction due to disconnected electrical components, incorrect urea solution and so on.

"xxx km (mile)" represents the remaining travel distance allowed, so do not continue driving to the limit of the remaining travel distance without fixing the source of the malfunction. Otherwise, the vehicle can't be restarted once the engine is turned off by the ENGINE START/STOP button. In this case, have your vehicle inspected by a professional workshop. Kia recommends to contact an authorised Kia dealer/service partner.

Clearing the vehicle-restarting restriction

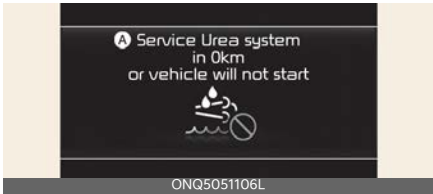
| No restart | |
|--|---|
| <p>Low urea solution level</p> |  <p>A: Refill urea tank or vehicle will not start</p> |
| <p>Urea solution system failure (= no urea solution injection)</p> |  <p>A: Service Urea system in 0km or vehicle will not start</p> |
| <p>Incorrect urea solution detected (= abnormal urea solution)</p> |  <p>A: Refill with correct urea in 000km or vehicle will not start</p> |
| <p>Abnormal urea-solution consumption (= post treatment failure)</p> |  <p>A: Service Urea system in 0km or vehicle will not start</p> |

Once the inducement system reached to final status and disabled the vehicle restart, it will only be deactivated in case the urea solution tank is replenished or the mal-functions have been rectified. If the vehicle can't be restarted with "Refill Urea tank or vehicle will not start" message, refill a sufficient amount of urea solution, wait for minutes and try vehicle starting again. If vehicle starting is not possible regardless of urea solution level, have your vehicle inspected by a professional workshop. Kia recommends to contact an authorised Kia dealer/service partner.

Adding urea solution

Refilling urea solution with a refill hose



Operation

1. Press the ENGINE START/STOP button to the OFF position.
2. Turn the urea solution tank cap in a counterclockwise direction to open it.
3. Fully insert the refill hose to add the ISO 22241-specified urea solution. Fill in a sufficient amount of urea solution.
 - * Pay great caution not to add the urea solution into the fuel tank. If not, it surely applies adverse impact on the vehicle performance, causing various malfunctions.
 - * Never use urea solution mixture with additives or water. It may allow foreign substances to enter the urea solution tank. If so, it surely applies adverse impact on the vehicle performance, causing various malfunctions.
 - * Use only the ISO 22241-specified urea solution. Any unauthorised urea solution surely applies adverse impacts on the vehicle performance, causing various malfunctions.
4. Turn the urea solution tank cap in a clockwise direction to securely close it. Refer to "Recommended lubricants and capacities" on page 10-7.

Refilling urea solution with a refill bottle

- Press the ENGINE START/STOP button to the OFF position.
- Turn the urea solution tank cap in a counterclockwise direction to open it.
- Add the ISO 22241-specified urea solution. Fill in a sufficient amount of urea solution.
 - * Pay great caution not to add the urea solution into the fuel tank. If not, it surely applies adverse impact on the vehicle performance, causing various malfunctions.
 - * Pay great caution not to overfill the (completely) filled urea solution tank by force whilst refilling urea solution from a refill bottle. An over-filled urea solution tank will be expanded when it becomes frozen and this can cause a serious malfunction of the urea solution tank or urea solution system.
 - * Never use urea solution mixture with additives or water. It may allow foreign substances to enter the urea solution tank. If so, it surely applies adverse impact on the vehicle performance, causing various malfunctions.
 - * Use only the ISO 22241-specified urea solution. Any unauthorised urea solution surely applies adverse impacts on the vehicle performance, causing various malfunctions.
- Turn the urea solution tank cap in a clockwise direction to securely close it.

Adding urea solution: Every approximately 5,600 km (The urea solution consumption is dependent on the road profile, driving pattern and environmental condition)

* It takes some time to update the cluster gauges after the urea solution injection.

WARNING

- Do not apply any external impact on the DPF system. It may damage the catalyst, which is equipped inside the DPF system.
- Do not arbitrarily modify or manipulate the DPF system by redirecting or lengthen the exhaust pipe. It may adversely impact the DPF system.
- Avoid contact with drained water from the exhaust pipe. The water is slightly acid and harmful to skin. If contacted, thoroughly wash it.
- Any arbitrary manipulation or modification of the DPF system may cause a system malfunction. The DPF system is controlled by a complex electronic control unit.
- Wait for the DPF system to cool down before the maintenance service, as it is hot due to heat generation. Otherwise, it may cause a skin burn.
- Add only the specified urea solution, when your vehicle is equipped with the urea solution system.
- The urea solution system (i.e. urea solution nozzle, urea solution pump, and DCU) operates for approximately 2 minutes more to eliminate the remaining urea solution inside, even after the ENGINE START/STOP button is pressed to the OFF position. Before the maintenance service, make sure that the urea solution system is completely turned OFF.
- A urea solution of poor quality or any unauthorised liquids may damage the vehicle components, including the DPF system. Any unverified additives

in the urea solution may clog the SCR catalyst and cause other malfunctions, which require the expensive DPF system to be replaced.

- When urea solution comes in contact with the eyes or the skin, you should thoroughly wash the contaminated skin area.
- When you swallow urea solution, thoroughly rinse your mouth and drink a lot of fresh water. Then, immediately consult a doctor.
- When your cloth is contaminated with urea solution, immediately change your cloth.
- When you have an allergic reaction to urea solution, immediately consult a doctor.
- Make sure that urea solution is kept out of reach from children.
- Wipe off any urea solution spillage with water or cloth. When urea solution is crystalized, wipe it off with a sponge or a cloth, which was dampened in cold water.

When urea solution spillage is exposed in air for an extended period of time, it is crystalized in white, damaging the vehicle surface.

- Urea solution is not a fuel additive. Thus, it should not be injected to the fuel tank. Otherwise, it may damage the engine.
- Urea solution is an aqueous solution, which is inflammable, non-toxic, colourless and odourless.
- Store the urea solution tank only in well-ventilated locations. When urea solution is exposed to the hot temperature at approximately 50°C for an extended period of time (i.e. under direct sunlight), the chemical decom-

position may occur, emitting ammonia vapour.

Storing urea solution

- It is improper to store urea solution in containers made of unsuitable materials like aluminium, copper alloy, non-alloyed still and galvanized steel. The urea solution dissolves metal materials, severely damaging the exhaust purification system to be non-repairable.
- Store urea solution only in containers made of the following materials.
 - DIN EN 10 088-1/-2/-3-specified CR-Ni steel, Mo-Cr-Ni steel, Polypropylene and Polyethylene

Urea solution purity

- The following situations may damage the DPF system.
 - Fuels or any unauthorised liquids are added into the urea solution tank.
 - Additives are mixed with urea solution.
 - Water is added to dilute the urea solution.
- Use only the ISO 22241- or DIN70070-specified urea solution. When any unauthorised urea solution is added to the urea solution tank, have your vehicle inspected by a professional workshop. Kia recommends to contact an authorised Kia dealer/service partner.
- When any unauthorised impurities enter the urea solution tank, it may lead to the following problems.
 - Increased emission
 - Malfunction with the DPF system
 - Engine failure

Never add any used urea solution, which is drained from the urea solution tank (i.e. whilst maintaining the vehicle). Its purity cannot be guaranteed. Always add new urea solution.

Specification of the standard urea solution

Liquid such as diesel, petrol and alcohol shall never be used for SCR system. Any fluid other than recommended urea solution (conform to ISO22241 or DIN70070) can damage SCR system hardware and deteriorate vehicle emission.

⚠ WARNING

- When opening the urea solution tank cap at high outside temperatures, ammonia vapours may escape. Ammonia vapours have a pungent smell and primarily cause irritation of the:
 - Skin
 - Mucous membranes
 - Eyes

You may experience a burning sensation in your eyes, nose and throat, as well as coughing and watering of the eyes. Do not inhale ammonia vapours. Do not allow urea solution to come in direct contact with your skin. It is hazardous to your health. Wash any affected areas off with plenty of clean water. If necessary, consult a doctor.
- When handling with urea solution in closed space, ensure good ventilation. When the bottle of urea solution container is opened, pungent smelling fumes may escape.
- Keep urea solution out of reach of children.
- When urea solution overflows the vehicle surface, wash out the surface with clean water to prevent any corrosion.

- When replenishing, be careful lest the urea solution should overflow.
- In case the vehicle was parked at very low ambient temperature (below -11 degree Celsius) for a long time, the urea solution will be frozen in the urea solution tank. With frozen urea solution, the urea solution tank level may not be detected correctly until the urea solution will be defrosted by activated heater. Incorrect urea solution or diluted urea solution can increase the freezing point, and thus defrosting may not be properly done by the heater which is activated below certain temperatures. This phenomenon may cause malfunction of the SCR system which can lead to the prohibition of engine restarting.
- The time to defrost the urea solution varies in accordance with driving conditions and outside temperatures.

vehicle such as processing device. If defective fuel is used, foreign objects will be accumulated to SCR catalyst and cause catalyst pushed away or breaking.

CAUTION

- If defective urea solution or unrecommended liquid is supplied, damage on car parts such as emission reduction devices can be caused. If defective fuel is added, foreign objects will be accumulated to SCR catalyst and cause it to get clogged and break. After adding incorrect urea solution, please visit the nearby authorised Kia dealer/ service partner as early as possible.
- Liquid that are not recommended such as diesel, petrol, and alcohol shall never be used other than the recommended urea solution that satisfy ISO22241 or DIN70070.
- If defective urea solution or liquid that is not recommended is supplied, there may be damage on the parts of the

Specifications & Consumer information **10**

| | |
|---|-------|
| Dimensions | 10-2 |
| Engine | 10-2 |
| Gross vehicle weight | 10-3 |
| Luggage volume | 10-4 |
| Air conditioning system..... | 10-4 |
| Bulb wattage | 10-5 |
| Tyres and wheels | 10-6 |
| Recommended lubricants and capacities | 10-7 |
| • Recommended SAE viscosity number..... | 10-9 |
| Vehicle Identification Number (VIN)..... | 10-10 |
| Vehicle certification label..... | 10-10 |
| Tyre specification and pressure label..... | 10-10 |
| Engine number | 10-11 |
| Air conditioner compressor label | 10-11 |
| Refrigerant label..... | 10-11 |
| Fuel label | 10-12 |
| Declaration of conformity | 10-13 |

Specifications & Consumer information

Dimensions

| Item | | mm (in) | |
|----------------|-------------------------|---------------|--------------|
| Overall length | | 4,660 (183.5) | |
| Overall width | | 1,865 (73.4) | |
| Overall height | Without Roof rack | 1,660 (65.4) | |
| | With Roof rack | 1,665 (65.6) | |
| | With Roof rack (X-Line) | 1,680 (66.1) | |
| Tread | Front | 235/65 R17 | 1,620 (63.8) |
| | | 235/60 R18 | 1,615 (63.6) |
| | | 235/55 R19 | |
| | Rear | 235/65 R17 | 1,627 (64.1) |
| | | 235/60 R18 | 1,622 (63.9) |
| | | 235/55 R19 | |
| Wheelbase | | 2,755 (108.5) | |

Engine

| Item | Smartstream G2.5 GDi | Smartstream G1.6 T-GDi | Smartstream G2.0 | Smartstream D2.0 |
|---------------------------|------------------------|------------------------|---------------------------|-----------------------|
| Displacement [cc (cu in)] | 2,497 (152.3) | 1,598 (97.5) | 1,999 (121.9) | 1,998 (121.9) |
| Bore x Stroke [mm (in)] | 88.5 x 101.5 (3.5 x 4) | 75.6 x 89.0 (3 x 3.5) | 81.0 x 97.0 (3.18 x 3.81) | 83 x 92.3 (3.2 x 3.6) |
| Firing order | 1-3-4-2 | 1-3-4-2 | 1-3-4-2 | 1-3-4-2 |
| No. of cylinders | 4 (inline) | 4 (inline) | 4 (inline) | 4 (inline) |

Gross vehicle weight

Type A: General specs (Except Type B, C and D)

Type B: Russian specs

Type C: Australian specs

Type D: European specs

| Item | Engine | Type | Specification | FWD | AWD |
|----------------------------------|------------------------|------|---------------|---|---|
| Gross vehicle weight [kg (lbs.)] | Smartstream G1.6 T-GDi | DCT | Type A | 2,105 (4,641) | 2,155 (4,751) |
| | | | Type B | - | - |
| | | | Type C | 2,085 (4,597) | 2,140 (4,718) |
| | | | Type D | 2,120 (4,674) | 2,175 (4,795) |
| | Smartstream G2.0 | MT | Type A | 2,030 (4,475) | - |
| | | | Type B | 2,055 (4,530) | 2,095 (4,619) |
| | | | Type C | 2,005 (4,420) | - |
| | | | Type D | 2,045 (4,508) | - |
| | | AT | Type A | 2,055 (4,530) | 2,120 (4,674) |
| | | | Type B | 2,085 (4,597) | 2,140 (4,718) |
| | | | Type C | 2,035 (4,486) | - |
| | | | Type D | For EURO 6D: 2,035 (4,486) Except EURO 6D: 2,070 (4,566) | 2,135 (4,707) |
| | Smartstream G2.5 GDi | AT | Type A | - | 2,160 (4,762) |
| | | | Type B | - | 2,175 (4,795) |
| | | | Type C | - | - |
| | | | Type D | - | 2,170 (4,784) |
| | Smartstream D2.0 | AT | Type A | 2,215 (4,883) | 2,285 (5,038) |
| | | | Type B | - | - |
| | | | Type C | - | 2,260 (4,982) |
| | | | Type D | For EURO 6D: 2,225 (4,905) Except EURO 6D: 2,205 (4,861) | For EURO 6D: 2,295 (5,060) Except EURO 6D: 2,275 (5,016) |

* Please contact your local authorised Kia dealer for the specs of your region.

Luggage volume

- Min: Behind rear seat to upper edge of the seatback
- Max: Behind front seat to roof

| Item | | | Luggage Volume | |
|-------------------------------------|--------|------|--------------------|----------------------------------|
| | | | Compact spare tyre | Full size spare tyre |
| Luggage volume (VDA) [L (cu ft)] | Petrol | MIN. | 586 (20.7) | 543 (19.2) |
| | | MAX. | 1,872 (66.1) | 1,829 (64.6) |
| | Diesel | MIN. | 544 (19.2) | 543 (19.2) (Without Urea tank) |
| | | MAX. | 1,830 (64.6) | 1,829 (64.6) (Without Urea tank) |

- MIN: Behind rear seat
- MAX: Behind front seat

| Item | | | Luggage Volume | |
|-------------------------------------|--------|------|--------------------|----------------------------------|
| | | | Compact spare tyre | Full size spare tyre |
| Luggage volume (SAE) [L (cu ft)] | Petrol | MIN. | 1,120 (39.6) | 1,037 (36.6) |
| | | MAX. | 2,098 (74.1) | 1,962 (69.3) |
| | Diesel | MIN. | 1,037 (36.6) | 1,037 (36.6) (Without Urea tank) |
| | | MAX. | 1,962 (69.3) | 1,962 (69.3) (Without Urea tank) |

Air conditioning system

Please contact a professional workshop for more details. Kia recommends to contact an authorised Kia dealer/service partner.

| Item | Weight of volume | Classification |
|----------------------|------------------|--------------------------|
| Refrigerant | 600±25 | R-134a |
| | 550±25 | R-1234yf |
| Compressor lubricant | 120±10 | TOTAL Planetelf PAG K 30 |

Bulb wattage

*: if equipped

| | Light bulb | | Bulb type | Wattage (Watt) |
|----------|------------------------------------|--------|--------------|----------------|
| Front | High beam | | LED | LED |
| | Low beam | | LED | LED |
| | Position and daytime running lamps | | LED | LED |
| | Front fog lamps* | | LED | LED |
| | Turn signal lamps | Type A | PY21W | 21 |
| Type B | | LED | LED | |
| Side | Side repeater lamps | | LED | LED |
| Rear | Stop lamps | Type A | P21/5W | 21/5 |
| | | Type B | LED | LED |
| | Tail lamps | | LED | LED |
| | Turn signal lamps | Type A | PY21W | 21 |
| | | Type B | LED | LED |
| | Backup lamps | | LED | LED |
| | Rear fog lamps | Type A | P21W | 21 |
| | | Type B | LED | LED |
| | High mounted stop lamp | | LED | LED |
| | License plate lamps | | W5W | 5 |
| Interior | Map lamps | Type A | WEDGE (W10W) | 10 |
| | | Type B | LED | LED |
| | Room lamps | Type A | FESTOON | 10 |
| | | Type B | LED | LED |
| | Personal lamps* | | LED | LED |
| | Vanity mirror lamps* | | FESTOON | 5 |
| | Glove box lamp* | | W5W | 5 |
| | Luggage lamp | Type A | FESTOON | 10 |
| Type B | | LED | LED | |

Tyres and wheels

*1. Load Index

*2. Speed Symbol

*3. if equipped

| Item | Tyre size | Wheel size | Load capacity | | Speed capacity | | Inflation pressure [bar (psi, kPa)] | | | | Wheel lug nut torque kgf·m (lbf·ft, N·m) |
|--|--|------------|-----------------|-----|------------------|------|-------------------------------------|------|---------------|------|---|
| | | | L ^{*1} | kg | SS ^{*2} | km/h | Normal load | | Maximum load | | |
| | | | | | | | Front | Rear | Front | Rear | |
| Full size tyre | 235/65R17 | 7.0J X 17" | 104 | 900 | H | 210 | 2.4 (35, 240) | | 2.4 (35, 240) | | 11-13 (79-94, 107-127) |
| | 235/60R18 | 7.5J X 18" | 103 | 875 | | | | | | | |
| | 235/55R19 | 7.5J X 19" | 101 | 825 | | | | | | | |
| Compact spare tyre (steel wheel) | T135/90D17 | 4B X 17" | 104 | 900 | M | 130 | 4.2 (60, 420) | | 4.2 (60, 420) | | |
| Compact spare tyre ^{*3} (alloy wheel) | Compact spare tyre's size is based on the full size tyre equipped on your vehicle. | | | | | | | | | | |

⚠ CAUTION

When replacing tyres, use the same size originally supplied with the vehicle. Using tyres of a different size can damage the related parts or make it work irregularly.

* NOTICE

- We recommend that when replacing tyres, use the same originally supplied with the vehicles. If not, that affects driving performance.
- When driving in high altitude grades, it is natural for the atmospheric pressure to decrease. Therefore, please check the tyre pressure and add more air when necessary.
 - Additionally required tyre air pressure per km above sea level: 1.5 psi/km

Recommended lubricants and capacities

To help achieve proper engine and powertrain performance and durability, use only lubricants of the proper quality. The correct lubricants also help promote engine efficiency that results in improved fuel economy. These lubricants and fluids are recommended for use in your vehicle.

| Lubricant | | | Volume (L) | Classification | |
|---|----------------------|---|---|---|--|
| Engine oil (drain and refill) Recommends ¹  TotalEnergies | Petrol | Smartstream G1.6 T-GDi | Except Middle East, Iran, Morocco, Algeria, Tunisia, Libya, Egypt, Sudan | 4.8 | SAE 0W-20, API SN PLUS/SP or ILSAC GF-6 ² |
| | | | For Middle East, Iran, Morocco, Algeria, Tunisia, Libya, Egypt, Sudan | | SAE 5W-30, ACEA A5/B5 ³ |
| | | Smartstream G2.0 | Except Middle East, Iran, Morocco, Algeria, Tunisia, Libya, Egypt, Sudan, India | 4.3 | SAE 0W-20, API SN PLUS/SP or ILSAC GF-6 ² |
| | | | For Middle East, Iran, Morocco, Algeria, Tunisia, Libya, Egypt, Sudan, India | | SAE 5W-30, ACEA A5/B5 ³ SAE 0W-30, API SN PLUS/SP or ILSAC GF-6 ² |
| | Smartstream G2.5 GDi | Except Middle East, Iran, Morocco, Algeria, Tunisia, Libya, Egypt, Sudan, India | 5.8 | SAE 0W-20, API SN PLUS/SP or ILSAC GF-6 ² | |
| | | For Middle East, Iran, Morocco, Algeria, Tunisia, Libya, Egypt, Sudan, India | | SAE 0W-30, ACEA C2 ³ | |
| Diesel | Smartstream D2.0 | 5.6 | ACEA C5, C2 or C3 (with DPF ⁴) ACEA A3 or B4 (without DPF ⁴) | | |
| Automatic transmission (AT) fluid ⁵ | Petrol | Smartstream G2.0 | 6.7 | SK ATF SP4M-1, MICHANG ATF SP4M-1, S-OIL ATF SP4M-1, Kia Genuine ATF SP4M-1 | |
| | | Smartstream G2.5 GDi | 6.5 | | |
| | Diesel | Smartstream D2.0 | 7.1 | | |
| Dual clutch transmission (DCT) fluid ⁵ | Petrol | Smartstream G1.6 T-GDi | 1.6~1.7 | HK D DCTF TGO-10 PLUS (SK), SPIRAX S6 GHDE 70W DCTF PLUS (H.K.SHELL), Kia genuine DCTF 70W SYNTHETIC PLUS | |
| Manual transmission (MT) fluid ⁵ | Petrol | Smartstream G2.0 | 1.5~1.6 | SAE 70W, API GL-4 HK SYN MTF 70W (SK), SPIRAX S6 GHME 70W MTF (H.K.SHELL), GS MTF HD 70W (GS CALTEX), Kia genuine MTF&DCTF 70W SYNTHETIC | |
| Coolant | Petrol | Smartstream G1.6 T-GDi | 7.5 | An Phosphate based ethylene glycol based coolant | |
| | | Smartstream G2.0 | 6.6 | | |
| | | Smartstream G2.5 GDi | 9.1 | | |
| | Diesel | Smartstream D2.0 | 8.7 | | |
| Brake fluid ⁶ | | | As required | SAE J1704 DOT-4 LV / FMVSS 116 DOT-4 / ISO4925 CLASS-6 | |

| Lubricant | | | Volume (L) | Classification |
|-----------------------------|--------------------------------|------------------------|------------|---|
| Rear differential oil (AWD) | | | 0.53~0.63 | |
| Transfer case oil (AWD) | Automatic transmission (AT) | | 0.62~0.68 | HYPOID GEAR OIL API GL-5, SAE 75W/85 (Recommended: SK HCT-5 GEAR OIL 75W85 or equivalent) |
| | Dual clutch transmission (DCT) | | 0.48~0.52 | |
| | Manual transmission (MT) | | | |
| Urea solution | Diesel | Smartstream D2.0 | 14 | ISO22241 |
| Fuel | Petrol | Smartstream G1.6 T-GDi | 54 | Petrol |
| | | Smartstream G2.0 | | |
| | | Smartstream G2.5 GDi | | |
| | Diesel | Smartstream D2.0 | 54 | Diesel |

- *1. Refer to "Recommended SAE viscosity number" on page 10-9.
- *2. Requires <API SN PLUS (or above) Full synthetic> grade engine oil. If a lower grade engine oil (mineral oil including Semi-synthetic) is used, then the engine oil and engine oil filter must be replaced as indicated severe maintenance condition.
- *3. Requires <API SN PLUS (or above) or ACEA C2/A5/B5 Full synthetic> grade engine oil. If a lower grade engine oil (mineral oil including Semi-synthetic) is used, then the engine oil and engine oil filter must be replaced as indicated severe maintenance condition.
- *4. Diesel Particulate Filter
- *5. If the genuine oil that is developed for best performance is not used, it may cause the problems of transmission performance.
- *6. To maintain your vehicle's best performance, use Kia genuine oil or those of an equivalent standard oil.

Recommended SAE viscosity number

Engine oil viscosity (thickness) has an effect on fuel economy and cold weather operating (engine start and engine oil flowability). Lower viscosity engine oils can provide better fuel economy and cold weather performance, however, higher viscosity engine oils are required for satisfactory lubrication in hot weather. Consider the range of temperature your vehicle will be operated in before the next oil change.

| | | Temperature Range for SAE Viscosity Numbers | | | | | | | | | |
|--|----|---|-----|-----|----|----|----|-----|-----|----|--|
| Temperature | °C | -30 | -20 | -10 | 0 | 10 | 20 | 30 | 40 | 50 | |
| | °F | -10 | 0 | 20 | 40 | 60 | 80 | 100 | 120 | | |
| (Except Middle East, Iran, Morocco, Algeria, Tunisia, Libya, Egypt, Sudan) • Smartstream G1.6 T-GDi | | 0W-20 | | | | | | | | | |
| (For Middle East, Iran, Morocco, Algeria, Tunisia, Libya, Egypt, Sudan) • Smartstream G1.6 T-GDi | | 5W-30 | | | | | | | | | |
| Smartstream G2.0 | | 0W-30, 5W-30 | | | | | | | | | |
| Smartstream G2.5 GDi | | 0W-30, 0W-20 | | | | | | | | | |
| Smartstream D2.0 | | 5W-30 0W-30, 0W-20 | | | | | | | | | |



An engine oil displaying this American Petroleum Institute (API) Certification Mark conforms to the International Lubricant Specification Advisory Committee (ILSAC). It is recommended to only use engine oils that uphold this API Certification Mark.

CAUTION

Always be sure to clean the area around any filler plug, drain plug, or dipstick before checking or draining any lubricant. This is especially important in dusty or sandy areas and when the vehicle is used on unpaved roads. Cleaning the plug and dipstick areas will prevent dirt and grit from entering the engine and other mechanisms that could be damaged.

*** NOTICE**

Never add any additives to the engine oil. Engine oil additives can change the properties of engine oil and may cause serious engine failure.

Vehicle Identification Number (VIN)

Type A



Type B



The Vehicle Identification Number (VIN) is the number used in registering your vehicle and in all legal matters pertaining to its ownership, etc.

- Type A: Engraved on the floor under the front right seat. Open the cover to check the VIN.
- Type B: Written on a plate attached to the top of the instrument panel through the front windscreen.

Vehicle certification label



The vehicle certification label attached on the driver's (or front passenger's) side centre pillar as shown gives the vehicle identification number (VIN).

Tyre specification and pressure label



The tyre label located on the centre pillar as shown gives the tyre pressures recommended for your vehicle. The tyres supplied on your new vehicle are chosen to provide the best performance for normal driving.

Engine number

Smartstream G2.5 GDi

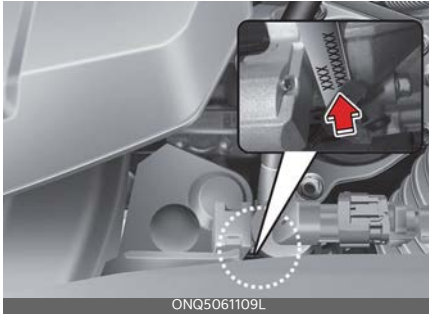

Smartstream G1.6 T-GDi

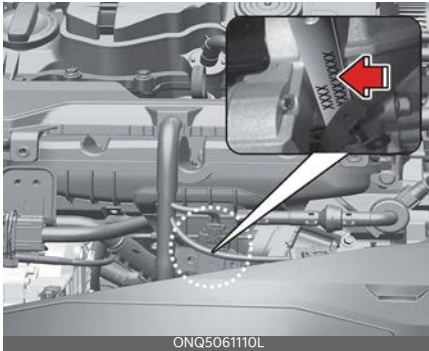

Smartstream G2.0



Smartstream D2.0



The engine number is stamped on the engine block as shown.

Air conditioner compressor label



A compressor label informs you the type of compressor your vehicle is equipped with such as model, supplier part number, production number, refrigerant (1) and refrigerant oil (2).

Refrigerant label



The refrigerant label is located as shown.

Fuel label

The fuel label is attached on the fuel filler door.

Petrol engine



- A. Octane rating of unleaded Petrol (Petrol)
 1. RON/ROZ: Research Octane Number
 2. (R+M)/2, AKI: Anti Knock Index
- B. Identifiers for Petrol-type fuels
 - * This symbol means usable fuel. Do not use any other fuel.
- C. For further details, refer to the "Fuel requirements" on page 1-2.

Diesel engine

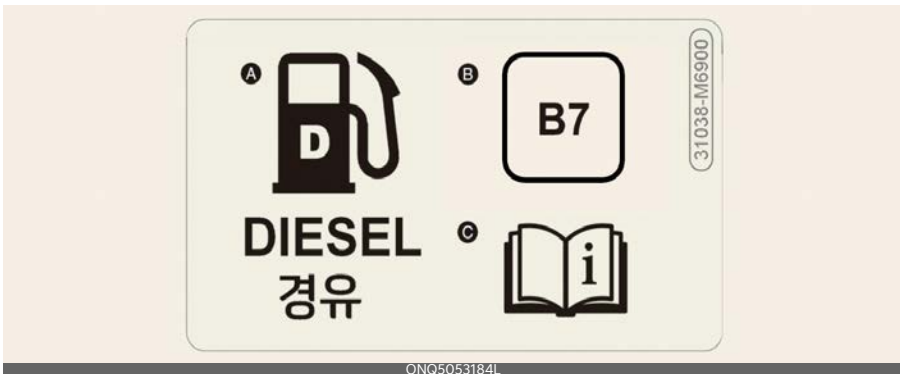

- A. Fuel: Diesel
- B. Identifiers for FAME containing Diesel-type Fuels
 - * This symbol means usable fuel. Do not use any other fuel.
- C. For further details, refer to the "Fuel requirements" on page 1-2.

Declaration of conformity

CE CE 0678

The radio frequency components of the vehicle comply with requirements and other relevant provisions of Directive 1995/5/EC.

Further information including the manufacturer's declaration of conformity is available on Kia website as follows:

<http://www.kia-hotline.com>

Abbreviation **A**

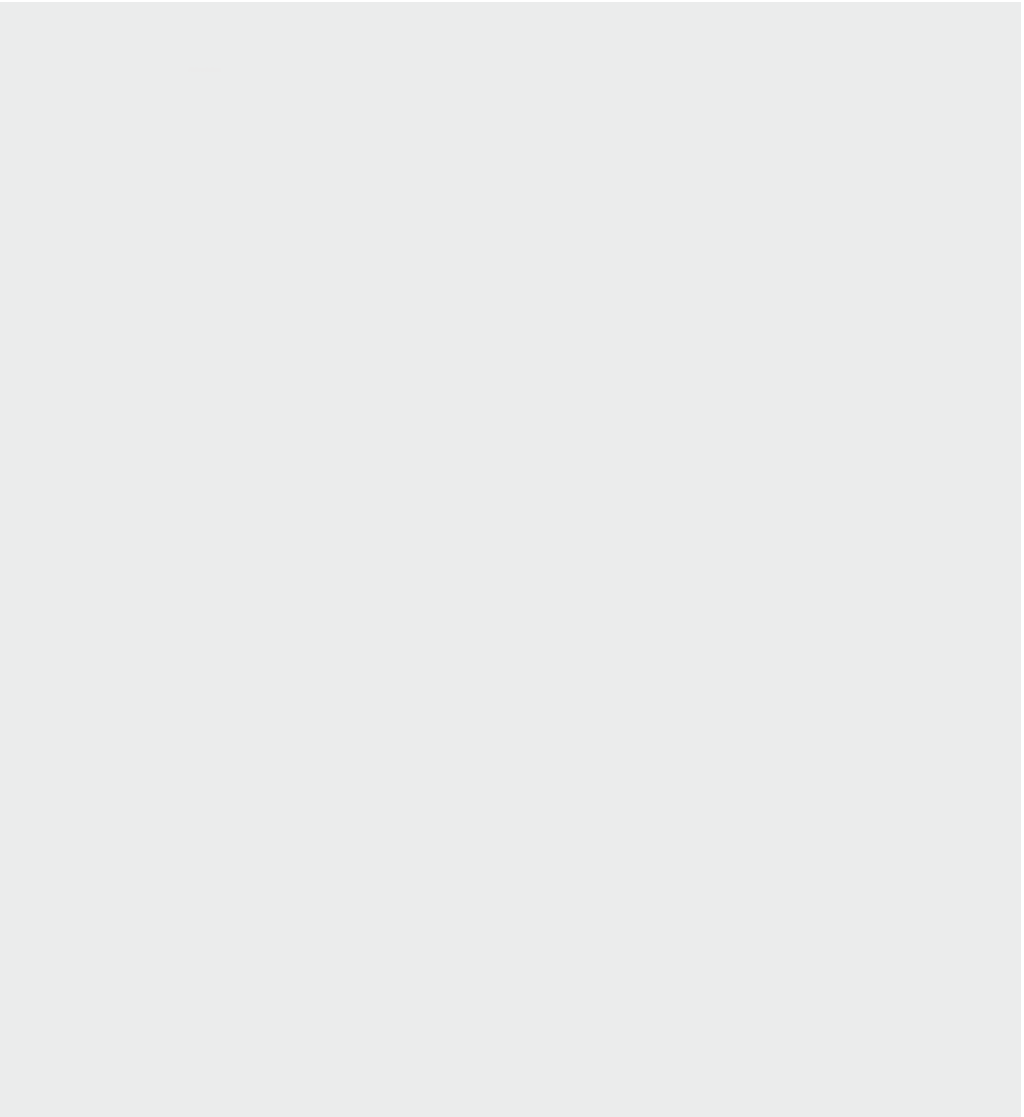

Abbreviation

ABS

Anti-lock Brake System

BAS

Brake Assistant System

BCA

Blind-Spot Collision-Avoidance Assist

BCW

Blind-Spot Collision Warning

BVM

Blind-Spot View Monitor

CC

Cruise Control

CRS

Child Restraint System

DAW

Driver Attention Warning

DBC

Downhill Brake Control

DRL

Daytime Running Light

EBD

Electronic Brake force Distribution

ECM

Electric Chromic Mirror

EPS

Electric Power Steering

ESC

Electronic Stability Control

ESS

Emergency Stop Signal

FCA

Forward Collision-Avoidance Assist

HAC

Hill-start Assist Control

HBA

High Beam Assist

HMSL

High Mounted Stop Lamp

ISLA

Intelligent Speed Limit Assist

LATCH

Lower Anchors and Tether for Children

LFA

Lane Following Assist

LKA

Lane Keeping Assist

MCB

Multi-Collision Brake

MDPS

Motor Driven Power Steering

MIL

Malfunction Indicator Lamp

MSLA

Manual Speed Limit Assist

PCA

Reverse Parking Collision-Avoidance Assist

Abbreviation

PDW

Reverse Parking Distance Warning

RCCA

Rear Cross-Traffic Collision-Avoidance Assist

RCCW

Rear Cross-Traffic Collision Warning

RVM

Rear View Monitor

SBW

Shift-By-Wire

SCC

Smart Cruise Control

SEA

Safe Exit Assist

SEW

Safe Exit Warning

SRS

Supplemental Restraint System

SRSCM

SRS Control Module

SVM

Surround View Monitor

TBT

Turn By Turn

TCS

Traction Control System

TIN

Tyre Identification Number

TPMS

Tyre Pressure Monitoring System

TSA

Trailer Stability Assist

VIN

Vehicle Identification Number

VSM

Vehicle Stability Management

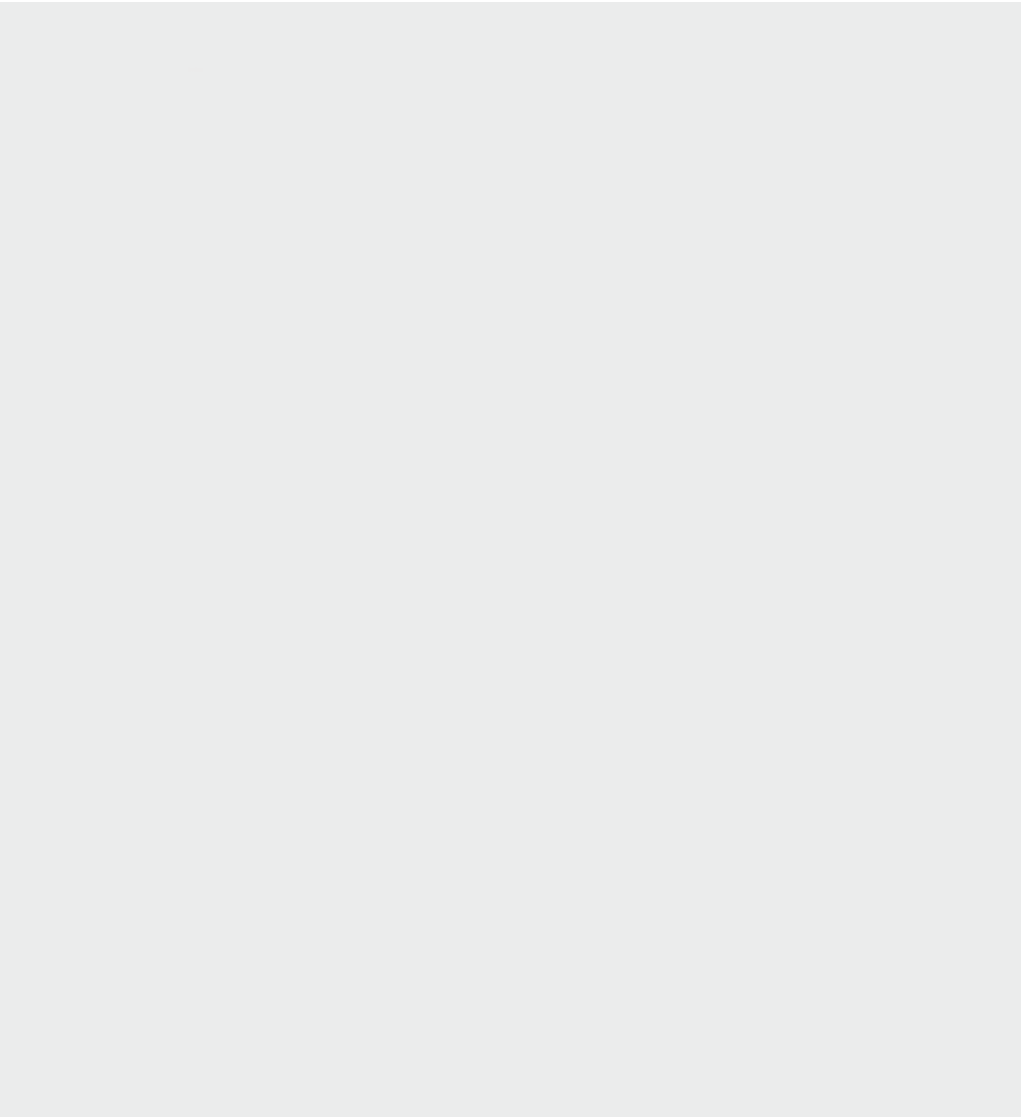

Index

A

| | |
|--|------|
| air bag | |
| air bag collision sensors | 3-43 |
| air bag warning labels | 3-49 |
| curtain air bag | 3-41 |
| driver's and passenger's front air bag | 3-38 |
| inflation conditions | 3-44 |
| non-inflation conditions | 3-45 |
| side air bag | 3-39 |
| SRS care | 3-47 |
| SRS components and functions | 3-36 |
| warning and indicator | 3-33 |
| air bag - supplemental restraint system | 3-31 |
| air bag collision sensors | 3-43 |
| air bag warning labels | 3-49 |
| air cleaner filter | 9-43 |
| all wheel drive (AWD) system | 6-40 |
| 4WD Lock Mode | 6-40 |
| emergency precautions | 6-43 |
| for safe 4WD operation | 6-41 |
| Terrain Mode | 6-40 |
| ambient light | 4-90 |
| anti-lock Brake System (ABS) | 6-33 |
| appearance care | 9-81 |
| exterior care | 9-81 |
| interior care | 9-85 |
| armrest | 3-11 |
| audio system | 5-3 |
| auto hold | 6-31 |
| automatic climate control system | |
| controlling fan speed | 4-83 |
| using the infotainment/climate switchable controller | 4-81 |
| automatic transmission | 6-12 |

B

| | |
|---|------|
| battery | 9-47 |
| before driving | 6-3 |
| blind-spot collision warning (BCW) | 7-32 |
| malfunction and limitations | 7-36 |

| | |
|--|------|
| operation | 7-34 |
| settings | 7-33 |
| blind-spot collision-avoidance assist (BCA) | 7-39 |
| malfunction and limitations | 7-46 |
| operation | 7-43 |
| settings | 7-41 |
| blind-spot view monitor (BVM) | 7-66 |
| malfunction | 7-67 |
| operation | 7-67 |
| settings | 7-66 |
| bonnet | 4-28 |
| closing the bonnet | 4-29 |
| opening the bonnet | 4-28 |
| brake Assist System (BAS) | 6-37 |
| brake system | 6-25 |
| applying the parking brake | 6-26 |
| auto hold | 6-31 |
| electronic parking brake (EPB) | 6-28 |
| parking brake | 6-26 |
| releasing the parking brake | 6-26 |
| brake/clutch fluid | 9-40 |
| bulb replacement precautions | 9-70 |

C

| | |
|--|------|
| care of seat belts | 3-21 |
| centre console storage/ glove box | 4-88 |
| child restraint system (CRS) | 3-22 |
| installing a CRS | 3-24 |
| ISOFIX anchorage system | 3-24 |
| climate control air filter | 9-44 |
| climate control system | 4-72 |
| coat hook | 4-95 |
| cruise control (CC) | 7-68 |
| operation | 7-68 |
| cup holders | 4-90 |
| curtain air bag | 3-41 |

D

| | |
|----------------------------------|-------|
| declaration of conformity | 7-134 |
| defogging (windscreen) | 4-85 |
| defrosting (windscreen) | 4-85 |
| door lock | 4-12 |
| door lock/unlock features | 4-15 |

| | |
|---|------|
| inside the vehicle | 4-13 |
| outside the vehicle | 4-12 |
| door locks | |
| rear occupant alert (ROA) | 4-16 |
| downhill Brake Control (DBC) | 6-34 |
| drive mode integrated control system | 6-38 |
| drive mode | 6-38 |
| driver attention warning (DAW) | 7-61 |
| malfunction and limitations | 7-64 |
| operation | 7-62 |
| settings | 7-61 |
| driver position memory system | 4-17 |
| easy access function | 4-17 |
| recalling memory position | 4-17 |
| resetting | 4-17 |
| setting memory position | 4-17 |
| driver's and passenger's front air bag | 3-38 |
| dual clutch transmission | 6-15 |

E

| | |
|---|------|
| economical operation | 6-45 |
| electronic parking brake (EPB) | 6-28 |
| electronic Stability Control (ESC) | 6-33 |
| emergency | 8-3 |
| emergency starting | 8-5 |
| engine overheats | 8-6 |
| flat tyre (with spare tyre) | 8-12 |
| if the engine will not start | 8-4 |
| in case of an emergency whilst driving | 8-3 |
| road warning | 8-3 |
| towing | 8-21 |
| emergency commodity | 8-24 |
| emergency precautions | 6-43 |
| emergency Stop Signal (ESS) | 6-36 |
| emergency towing | 8-22 |
| emission control system | 9-87 |
| engine compartment | 9-5 |
| engine coolant | 9-38 |
| engine oil | 9-35 |
| exterior features | 4-97 |
| roof rack | 4-97 |

F

| | |
|--|-------|
| flat tyre (with spare tyre) | 8-12 |
| floor mat anchors | 4-96 |
| for safe 4WD operation | 6-41 |
| forward collision-avoidance assist (FCA) - front camera only | 7-5 |
| malfunction and limitations | 7-9 |
| operation | 7-7 |
| settings | 7-5 |
| forward collision-avoidance assist (FCA) - sensor fusion type | 7-14 |
| malfunction and limitations | 7-21 |
| operation | 7-18 |
| settings | 7-16 |
| forward/reverse parking distance warning (PDW) | 7-112 |
| malfunction and precautions | 7-115 |
| operation | 7-113 |
| settings | 7-113 |
| front glass heater | 4-87 |
| fuel filler door | 4-30 |
| fuel filter (diesel) | 9-42 |
| fuel requirements | 1-2 |
| fuses | |
| driver's side fuse panel | 9-60 |
| replacing engine compartment fuse | 9-58 |
| replacing inner panel fuse | 9-58 |

H

| | |
|---|------|
| headlamp levelling adjustment switch | 4-66 |
| headrest | 3-9 |
| heated washer nozzle | 4-69 |
| hill-start Assist Control (HAC) | 6-35 |

I

| | |
|--|------|
| immobiliser system | 4-10 |
| importer information for united kingdom | 1-8 |
| infotainment system | 4-98 |
| audio (without touch screen) | 5-6 |
| bluetooth | 5-18 |
| media player | 5-15 |
| radio | 5-11 |

| | | | |
|--|------|--|------|
| specifications | 5-27 | LCD display | 4-45 |
| system status icons | 5-26 | LCD display modes | 4-46 |
| THE EMERGENCY CALL SERVICE | 5-26 | LCD display modes | |
| inside rear view mirror | 4-38 | driver assistance settings (infotainment system) | 4-51 |
| instrument cluster | 4-41 | driving assist mode | 4-47 |
| intelligent speed limit assist (ISLA) | 7-56 | information mode | 4-48 |
| malfunction and limitations | 7-59 | master warning mode | 4-49 |
| operation | 7-57 | service Interval | 4-49 |
| settings | 7-56 | trip computer mode | 4-47 |
| interior features | 4-90 | turn by turn (TBT) mode | 4-48 |
| ambient light | 4-90 | light bulbs | 9-70 |
| coat hook | 4-95 | bulb replacement precautions | 9-70 |
| cup holders | 4-90 | light position (front) | 9-71 |
| floor mat anchors | 4-96 | light position (rear) | 9-72 |
| power outlet | 4-93 | light position (side) | 9-72 |
| seat warmer/ventilation | 4-90 | replacing license plate lamp (Bulb type) | 9-74 |
| side curtain | 4-96 | replacing lights (LED type) | 9-72 |
| sun visor | 4-91 | lighting | 4-60 |
| USB charger | 4-92 | high beam assist (HBA) | 4-63 |
| wireless smart phone charging system | 4-93 | | |
| interior light | 4-70 | | |
| automatic turn off function | 4-70 | M | |
| glove box lamp | 4-72 | maintenance | |
| luggage room lamp | 4-71 | air cleaner filter | 9-43 |
| map lamp | 4-70 | appearance care | 9-81 |
| personal lamp | 4-71 | battery | 9-47 |
| room lamp | 4-71 | brake/clutch fluid | 9-40 |
| vanity mirror lamp | 4-72 | climate control air filter | 9-44 |
| ISOFIX anchorage system | 3-24 | emission control system | 9-87 |
| | | engine coolant | 9-38 |
| | | engine oil | 9-35 |
| | | fuel filter (diesel) | 9-42 |
| K | | parking brake | 9-41 |
| key | 4-6 | tyres and wheels | 9-49 |
| immobiliser system | 4-10 | washer fluid | 9-41 |
| replacing the key battery | 4-6 | wiper blades | 9-45 |
| | | maintenance services | 9-7 |
| | | owner maintenance schedule | 9-8 |
| L | | manual climate control system | 4-78 |
| lane following assist (LFA) | 7-83 | manual speed limit assist (MSLA) | 7-54 |
| malfunction and limitations | 7-85 | operation | 7-54 |
| operation | 7-84 | manual transmission | 6-10 |
| settings | 7-83 | mirrors | 4-38 |
| lane keeping assist (LKA) | 7-26 | adjusting the day/night rear view mirror | 4-38 |
| malfunction and limitations | 7-30 | | |
| operation | 7-28 | | |
| settings | 7-27 | | |

| | | | |
|--|-------|---|-------|
| electric chromic mirror (ECM) | 4-38 | malfunction and limitations | 7-130 |
| inside rear view mirror | 4-38 | operation | 7-126 |
| outside rear view mirror | 4-39 | settings | 7-124 |
| multi-collision brake (MCB) | 6-35 | replacing lights (LED type) | 9-72 |
| <hr/> | | | |
| O | | reverse parking collision-avoidance assist (PCA) | 7-117 |
| open source software notice | 1-7 | malfunction and limitations | 7-119 |
| opening the bonnet | 4-28 | operation | 7-118 |
| <hr/> | | | |
| P | | settings | 7-117 |
| paddle shifter | 6-24 | reverse parking distance warning (PDW) | 7-109 |
| panorama sunroof | 4-32 | malfunction and precautions | 7-111 |
| automatic reversal | 4-34 | operation | 7-110 |
| resetting the sunroof | 4-35 | settings | 7-109 |
| slide open/close | 4-33 | risk of burns when parking or stopping vehicle | 1-6 |
| sunroof open warning | 4-35 | roof rack | 4-97 |
| tilt open/close | 4-33 | <hr/> | |
| parking brake | | S | |
| checking the parking brake | 9-41 | safe exit warning (SEW) | 7-50 |
| passenger's front air bag ON/OFF switch | 3-34 | malfunction and limitations | 7-52 |
| power outlet | 4-93 | operation | 7-51 |
| <hr/> | | | |
| R | | settings | 7-50 |
| rear cross-traffic collision warning (RCCW) | 7-94 | scheduled maintenance items | 9-32 |
| rear cross-traffic collision-avoidance assist (RCCA) | 7-100 | air cleaner filter | 9-33 |
| malfunction and limitations | 7-105 | air conditioning refrigerant | 9-34 |
| operation | 7-102 | automatic transmission fluid | 9-33 |
| settings | 7-101 | brake discs, pads, calipers and rotors | 9-34 |
| rear cross-traffic collision-avoidance warning (RCCW) | | brake fluid | 9-34 |
| malfunction and limitations | 7-97 | brake hoses and lines | 9-34 |
| operation | 7-95 | coolant | 9-33 |
| settings | 7-94 | cooling system | 9-33 |
| rear occupant alert (ROA) | 4-16 | drive belts | 9-32 |
| rear view monitor (RVM) | 7-86 | drive shafts and boots | 9-34 |
| malfunction and limitations | 7-88 | dual clutch transmission fluid | 9-33 |
| operation | 7-87 | fluid levels | 9-34 |
| settings | 7-86 | fuel filter cartridge (for diesel) | 9-32 |
| remote key | 4-7 | fuel filter (for petrol) | 9-32 |
| remote smart parking assist (RSPA) | 7-123 | fuel lines, fuel hoses and connections | 9-32 |
| | | parking brake | 9-34 |
| | | spark plugs (for petrol engine) | 9-33 |
| | | steering gear box, linkage & boots/lower arm ball joint | 9-34 |
| | | suspension mounting bolts | 9-34 |
| | | vacuum crankcase ventilation hoses | 9-33 |

| | | | |
|---|------------|---|------|
| vapour hose (for petrol engine) and fuel filler cap | 9-32 | malfunction and limitations | 7-93 |
| scheduled maintenance | | operation | 7-91 |
| service | 9-9, 9-17 | settings | 7-89 |
| seat | 3-3 | | |
| feature of seat leather | 3-4 | T | |
| seat belt precautions | 3-19 | tailgate | 4-18 |
| seat belt restraint system | 3-13 | theft-alarm system | 4-11 |
| seat belts | 3-12 | armed stage | 4-11 |
| seat leather | 3-4 | disarmed stage | 4-12 |
| seat warmer/ventilation | 4-90 | theft-alarm stage | 4-11 |
| side air bag | 3-39 | towing | 8-21 |
| side curtain | 4-96 | emergency towing | 8-22 |
| smart cruise control (SCC) | 7-70 | towing service | 8-21 |
| display and control | 7-74 | towing service | 8-21 |
| malfunction and limitations | 7-78 | trailer Stability Assist (TSA) | 6-37 |
| settings | 7-71, 7-74 | trailer towing | 6-53 |
| smart key | 4-8 | driving with a trailer | 6-55 |
| special driving conditions | 6-46 | hitches | 6-54 |
| specifications | 10-2 | maintenance | 6-57 |
| air conditioner compressor label | 10-11 | safety chains | 6-54 |
| air conditioning system | 10-4 | trailer brakes | 6-55 |
| bulb wattage | 10-5 | transmission | 6-10 |
| declaration of conformity | 10-13 | LCD display messages | 6-19 |
| dimensions | 10-2 | Tyre Pressure Monitoring System (TPMS) | 8-8 |
| engine | 10-2 | tyres and wheels | 9-49 |
| engine number | 10-11 | checking tyre inflation pressure | 9-49 |
| fuel label | 10-12 | low aspect ratio tyre | 9-55 |
| gross vehicle weight | 10-3 | recommended cold tyre inflation pressures | 9-49 |
| luggage volume | 10-4 | tyre care | 9-49 |
| recommended lubricants and capacities | 10-7 | tyre maintenance | 9-53 |
| refrigerant label | 10-11 | tyre replacement | 9-51 |
| tyre specification and pressure label | 10-10 | tyre rotation | 9-51 |
| tyres and wheels | 10-6 | tyre sidewall labeling | 9-53 |
| vehicle certification label | 10-10 | tyre traction | 9-53 |
| vehicle identification number (VIN) | 10-10 | wheel alignment and tyre balance | 9-51 |
| starting the vehicle | 6-6 | wheel replacement | 9-52 |
| steering wheel | 4-36 | | |
| heated steering wheel | 4-37 | U | |
| horn | 4-38 | USB charger | 4-92 |
| storage compartment | 4-88 | using the infotainment/climate switchable controller | 4-98 |
| centre console storage/glove box | 4-88 | | |
| sun visor | 4-91 | | |
| sunshade | 4-33 | | |
| surround view monitor (SVM) | 7-89 | | |

V

| | |
|---|------|
| vehicle break-in process | 1-6 |
| vehicle handling instructions | 1-7 |
| vehicle modifications | 1-5 |
| vehicle safety system | 6-33 |
| anti-lock Brake System (ABS) | 6-33 |
| Brake Assistant System (BAS) | 6-37 |
| downhill Brake Control (DBC) | 6-34 |
| electronic Stability Control (ESC) | 6-33 |
| emergency Stop Signal (ESS) | 6-36 |
| hill-start Assist Control (HAC) | 6-35 |
| multi-collision brake (MCB) | 6-35 |
| trailer Stability Assist (TSA) | 6-37 |
| vehicle Stability Management (VSM) | 6-36 |
| vehicle settings (infotainment system) | 4-54 |
| vehicle Stability Management (VSM) | 6-36 |
| vehicle weight | 6-61 |

W

| | |
|---|------|
| warning and indicator lights | 4-55 |
| washer fluid | 9-41 |
| windows | 4-24 |
| power window lock button | 4-26 |
| remote window closing/opening | 4-27 |
| windscreen defrosting and defogging | 4-85 |
| front glass heater | 4-87 |
| winter driving | 6-49 |
| wiper blades | 9-45 |
| wipers and washers | 4-66 |
| heated washer nozzle | 4-69 |
| wireless smart phone charging system | 4-93 |

