

FOREWORD

Dear Customer,

Thank you for selecting your new Kia vehicle.

As a global car manufacturer focused on building high-quality vehicles with exceptional value, Kia is dedicated to providing you with a customer service experience that exceeds your expectations.

This Owner's Manual will acquaint you with the operation of features and equipment that are either standard or optional on this vehicle, along with the maintenance needs of this vehicle. Therefore, you may find certain descriptions and illustrations not applicable to your vehicle. You are advised to read this publication carefully and follow the instructions and recommendations. Please always keep this manual in the vehicle for your and any subsequent owner's reference.

Authorized Kia Dealerships provide factory-trained technicians, utilized recommended special service tools, and supply genuine Kia replacement parts to help you maintain and service your vehicle during your ownership.

All information contained in this Owner's Manual was accurate at the time of publication. However, as Kia continues to make improvements to its products, the company reserves the right to make changes to this manual or any of its vehicles at any time without notice and without incurring any obligations.

Please drive safely, and enjoy your Kia vehicle!

© 2022 Kia Corporation

All rights reserved. May not be reproduced or translated in whole or in part without the written consent of Kia Corporation

Printed in Korea

How to use this manual

We want to help you get the greatest possible driving pleasure from your vehicle. Your Owner's Manual can assist you in many ways.

We strongly recommend that you read the entire manual. In order to minimise the chance of death or injury, you must read the WARNING and CAUTION sections in the manual.

Illustrations complement the words in this manual to best explain how to enjoy your vehicle. By reading your manual, you learn about features, important safety information, and driving tips under various road conditions.

The general layout of the manual is provided in the Table of Contents. Use the index when looking for a specific area or subject, it has an alphabetical listing of all information in your manual.

Chapters: This manual has nine chapters plus an index. Each chapter begins with a brief list of contents so you can tell at a glance if that chapter has the information you want.

You will find various WARNINGS, CAUTIONS, and NOTICES in this manual. These WARNINGS were prepared to enhance your personal safety. You should carefully read and follow ALL procedures and recommendations provided in these WARNINGS, CAUTIONS and NOTICES.

WARNING

A WARNING indicates a situation in which harm, serious bodily injury or death could result if the warning is ignored.

CAUTION

A CAUTION indicates a situation in which damage to your vehicle could result if the caution is ignored.

NOTICE

A NOTICE indicates interesting or helpful information is being provided.

Table of Contents

Introduction	①
Your vehicle at a glance	②
Safety features of your vehicle	③
Features of your vehicle	④
Infotainment system	⑤
Driving your vehicle	⑥
What to do in an emergency	⑦
Maintenance	⑧
Specifications & Consumer information	⑨
Abbreviation	Ⓐ
Index	Ⓛ

Fuel requirements	1-2
• Petrol engine	1-2
VEHICLE MODIFICATIONS.....	1-4
Vehicle break-In process	1-5
Risk of burns when parking or stopping vehicle	1-5

Introduction

Fuel requirements

Petrol engine

Unleaded

For Europe

For the optimal vehicle performance, we recommend you to use unleaded petrol with an octane rating of RON (Research Octane Number) 95 / AKI (Anti Knock Index) 91 or higher.

You may use unleaded petrol with an octane rating of RON 91~94 / AKI 87~90 but it may result in slight performance reduction of the vehicle. (Do not use methanol blended fuels.)

Except Europe

Your new Kia vehicle is designed to use only unleaded fuel having an Octane Rating of RON (Research Octane Number) 91 / AKI (AntiKnock Index) 87 or higher. (Do not use methanol blended fuels.)

Your new vehicle is designed to obtain maximum performance with UNLEADED FUEL, as well as minimise exhaust emissions and spark plug fouling.

CAUTION

NEVER USE LEADED FUEL. The use of leaded fuel is detrimental to the catalytic converter and will damage the engine control system's oxygen sensor and affect emission control.

Never add any fuel system cleaning agents to the fuel tank other than what has been specified. (Kia recommends to consult an authorised Kia dealer/service partner for details.)

WARNING

- Do not "top off" after the nozzle automatically shuts off when refuelling.
- Always check that the fuel cap is installed securely to prevent fuel spillage in the event of an accident.

Leaded (if equipped)

For some countries, your vehicle is designed to use leaded petrol. When you are going to use leaded petrol, Kia recommends to visit an authorised Kia dealer/service partner and ask whether leaded petrol in your vehicle is available or not.

Octane Rating of leaded petrol is same with unleaded one.

Petrol containing alcohol and methanol

Gasohol, a mixture of petrol and ethanol (also known as grain alcohol), and petrol or gasohol containing methanol (also known as wood alcohol) are being marketed along with or instead of leaded or unleaded petrol.

Do not use gasohol containing more than 10% ethanol, and do not use petrol or gasohol containing any methanol. Either of these fuels may cause drivability problems and damage to the fuel system, engine control system and emission control system.

Discontinue using gasohol of any kind if drivability problems occur.

Vehicle damage or drivability problems may not be covered by the manufacturer's warranty if they result from the use of:

1. Gasohol containing more than 10% ethanol.

2. petrol or gasohol containing methanol.
3. Leaded fuel or leaded gasohol.

⚠ CAUTION

Never use gasohol which contains methanol. Discontinue use of any gasohol product which impairs drivability.

Other fuels

Using fuels such as

- Silicone (Si) contained fuel,
- MMT (Manganese, Mn) contained fuel,
- Ferrocene (Fe) contained fuel, and
- Other metallic additives contained fuels, may cause vehicle and engine damage or cause plugging, misfiring, poor acceleration, engine stalling, catalyst melting, abnormal corrosion, life cycle reduction, etc.

Also, the Malfunction Indicator Lamp (MIL) may illuminate.

*** NOTICE**

Damage to the fuel system or performance problem caused by the use of these fuels may not be covered by your New Vehicle Limited Warranty.

Use of MTBE

Kia recommends avoiding fuels containing MTBE (Methyl Tertiary Butyl Ether) over 15.0% vol. (Oxygen Content 2.7% weight) in your vehicle.

Fuel containing MTBE over 15.0% vol. (Oxygen Content 2.7% weight) may reduce vehicle performance and produce vapour lock or hard starting.

⚠ CAUTION

Your New Vehicle Limited Warranty may not cover damage to the fuel system and any performance problems that are caused by the use of fuels containing methanol or fuels containing MTBE (Methyl Tertiary Butyl Ether) over 15.0% vol. (Oxygen Content 2.7% weight).

Do not use methanol

Fuels containing methanol (wood alcohol) should not be used in your vehicle. This type of fuel can reduce vehicle performance and damage components of the fuel system, engine control system and emission control system.

Fuel Additives

Kia recommends that you use unleaded petrol which has an octane rating of RON (Research Octane Number) 95 / AKI (Anti Knock Index) 91 or higher (for Europe) or Octane Rating of RON (Research Octane Number) 91 / AKI (Anti-Knock Index) 87 or higher (except Europe).

For customers who do not use good quality petrols including fuel additives regularly, and have problems starting or the engine does not run smoothly, one bottle of additives added to the fuel tank when the engine oil is replaced.

Additives are available from a professional workshop along with information on how to use them. Kia recommends to visit an authorised Kia dealer/service partner. Do not mix other additives.

Operation in foreign countries

If you are going to drive your vehicle in another country, be sure to:

- Observe all regulations regarding registration and insurance.

- Determine that acceptable fuel is available.

VEHICLE MODIFICATIONS

This vehicle should not be modified. Modification of your vehicle could affect its performance, safety or durability and may even violate governmental safety and emissions regulations.

In addition, damage or performance problems resulting from any modification may not be covered under warranty.

- If you use unauthorised electronic devices, it may cause the vehicle to operate abnormally, wire damage, battery discharge and fire. For your safety, do not use unauthorised electronic devices.

Vehicle break-In process

By following a few simple precautions for the first 1,000 km (600 miles) you may add to the performance, economy and life of your vehicle.

- Do not race the engine.
- Whilst driving, keep your engine speed (rpm, or revolutions per minute) within 3,000 rpm.
- Do not maintain a single speed for long periods of time, either fast or slow. Varying engine speed is needed to properly break-in the engine.
- Avoid hard stops, except in emergencies, to allow the brakes to seat properly.
- Don't tow a trailer during the first 2,000 km (1,200 miles) of operation.
- Fuel economy and engine performance may vary depending on vehicle break-in process and be stabilized after 6,000 km (4,000 miles). New engines may consume more oil during the vehicle break-in period.

Risk of burns when parking or stopping vehicle

WARNING

- Do not park or stop the vehicle near flammable items such as leaves, paper, oil, and tyre. Such items placed near the exhaust system can become a fire hazard.
 - When an engine idles at a high speed with the rear side of the vehicle touching the wall, heat of the exhaust gas can cause discoloration or fire. Keep enough space between the rear part of the vehicle and the wall.
 - Be sure not to touch the exhaust/catalytic systems whilst engine is running or right after the engine is turned off. There is a risk of burns since the systems are extremely hot.
-

Your vehicle at a glance **2**

Exterior overview	2-2
Interior overview	2-5
Instrument panel overview	2-7
Engine compartment.....	2-9

Your vehicle at a glance

Exterior overview

Front view



OBD011001R

* The actual shape may differ from the illustration.

1. Bonnet	4-37
2. Head lamp (Features of your vehicle)	4-100
Head lamp (Maintenance)	8-80
3. Wheel and tyre	8-55, 9-8
4. Outside rear view mirror	4-49
5. Sunroof	4-41
6. Front windscreen wiper blades (Features of your vehicle)	4-110
Front windscreen wiper blades (Maintenance)	8-50
7. Windows	4-32
8. Front ultrasonic sensors	4-96
9. Front fog lamp	8-80

Rear view (4 Door)

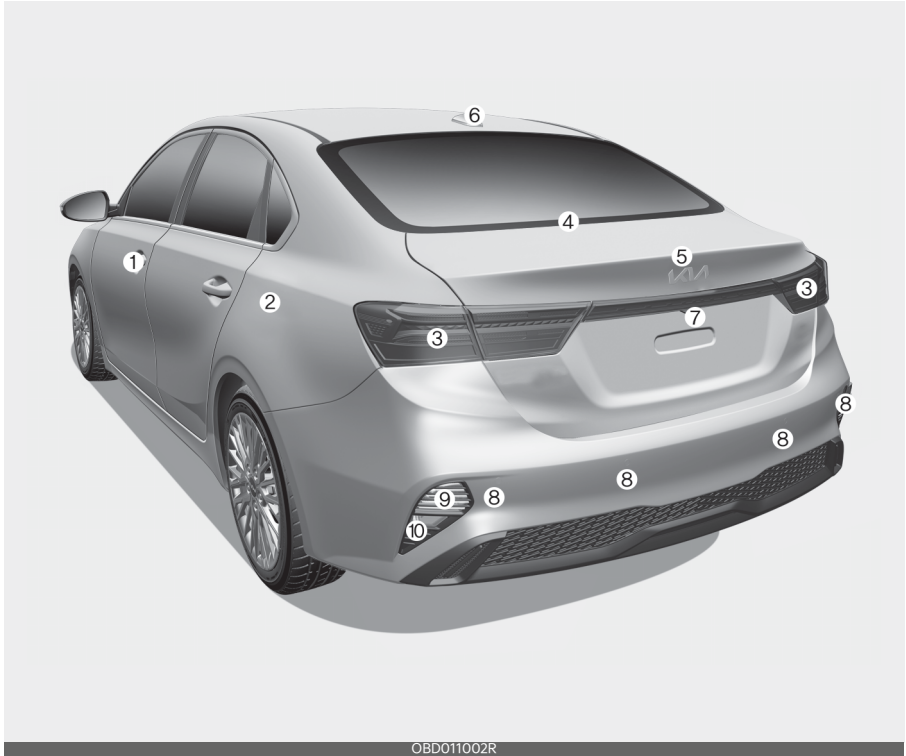

OBD011002R

* The actual shape may differ from the illustration.

1. Door locks	4-15
2. Fuel filler door	4-39
3. Rear combination lamp (Maintenance)	8-81
4. High mounted stop lamp (Maintenance)	8-81
5. Trunk	4-25
6. Antenna	5-3
7. Wide-rear view camera	4-89
8. Rear ultrasonic sensors	4-93, 4-96
9. Rear turn signal lamp (Maintenance)	8-81
10. Back Up lamp (Maintenance)	8-81

Rear view (5 Door)

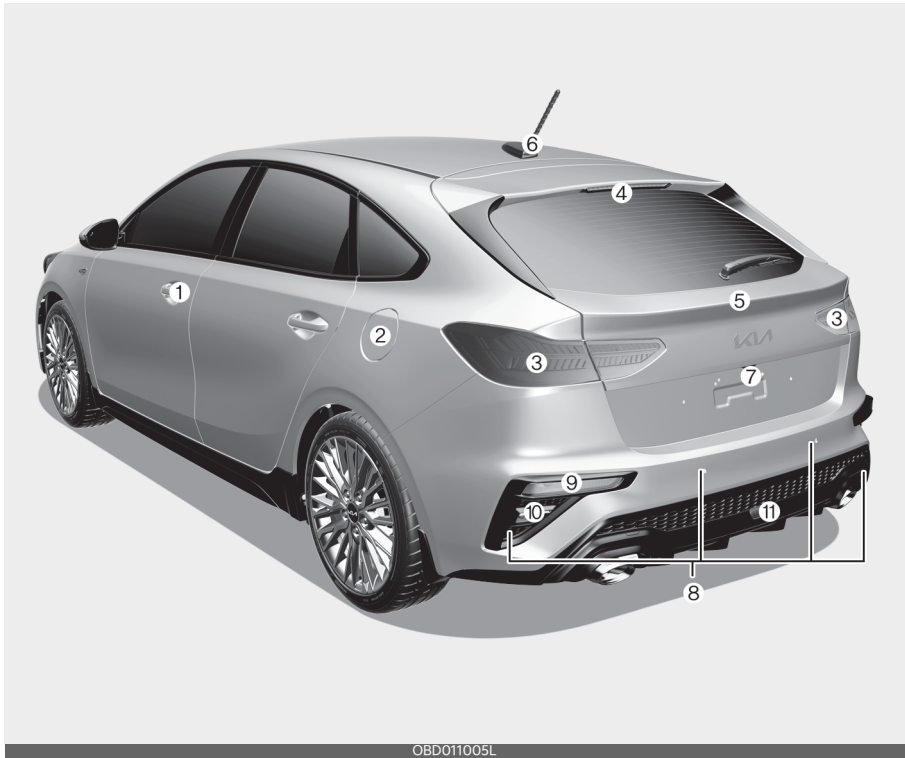

OBD011005L

* The actual shape may differ from the illustration.

1. Door locks	4-15
2. Fuel filler door	4-39
3. Rear combination lamp (Maintenance)	8-81
4. High mounted stop lamp (Maintenance)	8-81
5. Tailgate	4-30
6. Antenna	5-3
7. Wide-rear view camera	4-89
8. Rear ultrasonic sensors	4-93, 4-96
9. Rear turn signal lamp (Maintenance)	8-81
10. Back Up lamp (Maintenance)	8-81
11. Rear fog lamp (Features of your vehicle)	4-106
Rear fog lamp ((Maintenance)	8-81

Interior overview

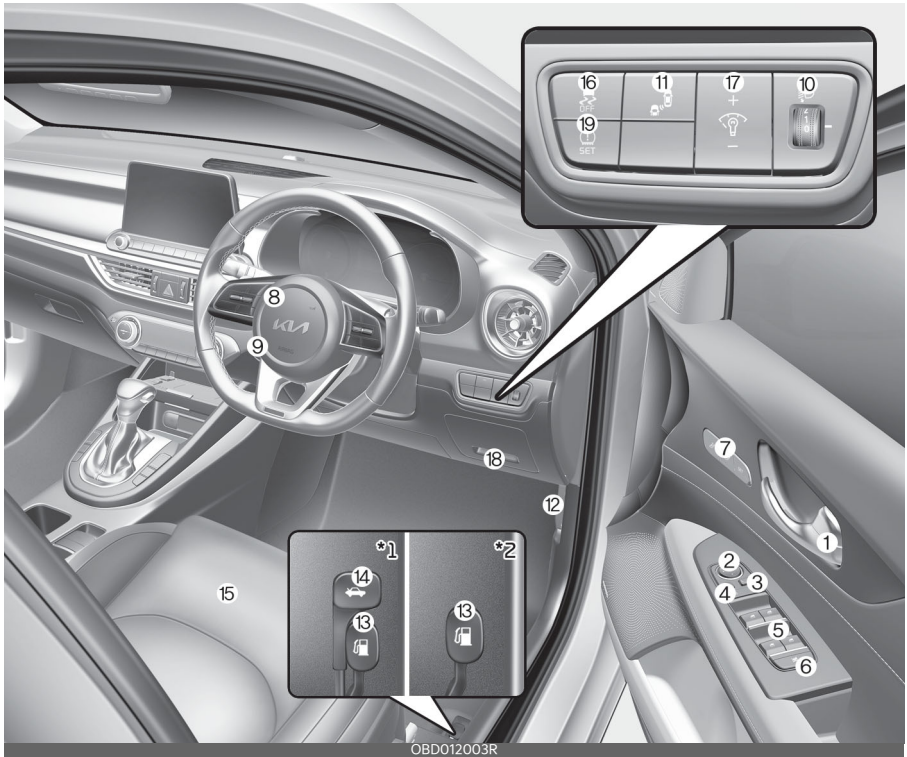

* The actual shape may differ from the illustration.

* 1: 4 Door *2: 5 Door

- | | |
|---|-------|
| 1. Inside door handle | 4-17 |
| 2. Outside rearview mirror control switch | 4-50 |
| 3. Outside rearview mirror folding button | 4-51 |
| 4. Central door lock/unlock switch | 4-18 |
| 5. Power window switch | 4-32 |
| 6. Power window lock button | 4-35 |
| 7. Driver position memory button | 3-8 |
| 8. Steering wheel | 4-45 |
| 9. Tilt and telescopic steering control lever | 4-46 |
| 10. Headlight levelling device | 4-109 |
| 11. Blind-Spot Safety button | 6-94 |
| 12. Bonnet release lever | 4-37 |

13.Fuel filler door release lever	4-39
14.Trunk release lever	4-25
15.Seat	3-3
16.ESC OFF button	6-49
17.Instrument panel illumination control	4-53
18.Inner fuse panel	8-63
19.Tyre pressure monitoring system SET button	7-7

Instrument panel overview

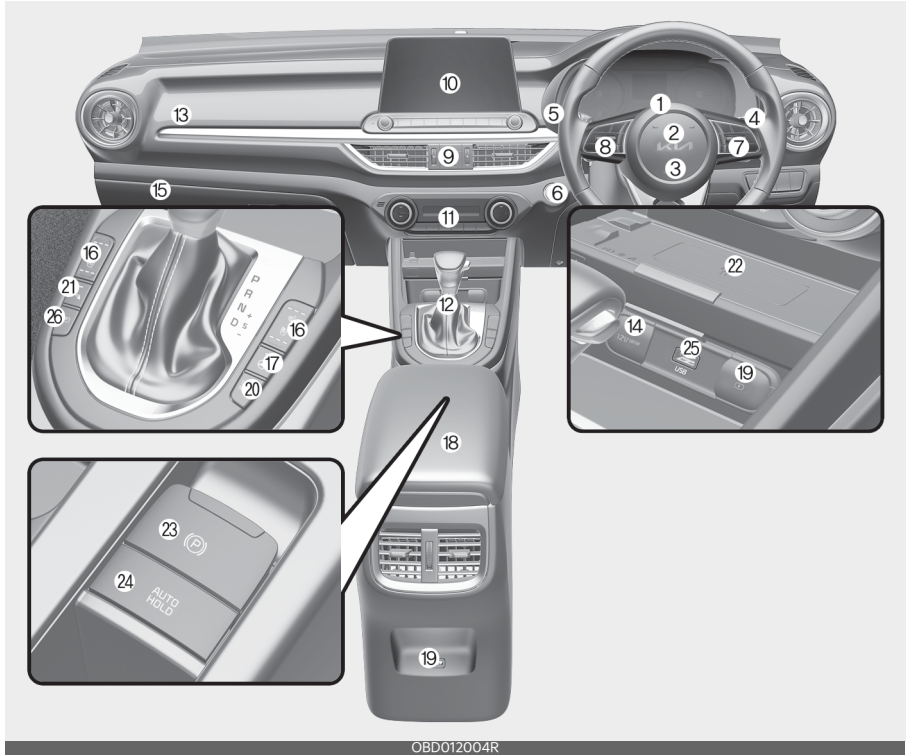

* The actual shape may differ from the illustration.

- | | |
|--|-----------|
| 1. Instrument cluster | 4-52 |
| 2. Horn | 4-47 |
| 3. Driver's front air bag | 3-47 |
| 4. Wiper and washer control lever (For Europe) | 4-110 |
| Light control/Turn signals lever (Except Europe) | 4-101 |
| 5. Light control/Turn signals lever (For Europe) | 4-101 |
| Wiper and washer control lever (Except Europe) | 4-110 |
| 6. Ignition switch or ENGINE START/STOP button | 6-8, 6-11 |
| 7. Driving Assist button | 6-117 |
| 8. Steering wheel audio control
(Refer to "Car Infotainment System Quick Reference Guide".) | |
| 9. Hazard warning flasher | 7-2 |

10. Infotainment System (Refer to "Car Infotainment System Quick Reference Guide".)	
11. Climate control system	4-120, 4-126
12. Shift lever	6-16, 6-19, 6-25, 6-32
13. Passenger's front air bag	3-47
14. Power outlet	4-146
15. Glove box	4-139
16. Seat warmer	4-142
Air ventilation seat	4-144
17. Heated steering wheel button	4-47
18. Centre console storage	4-139
19. USB charger	4-145
20. Drive mode button	6-54
21. Parking Safety button	4-97
22. Wireless smart phone charging system	4-146
23. Electronic Parking Brake (EPB) switch	6-41
24. Auto Hold On/Off button	6-44
25. USB port	5-4
26. Parking/View button	4-90

Engine compartment

(Petrol) 1.6 MPI

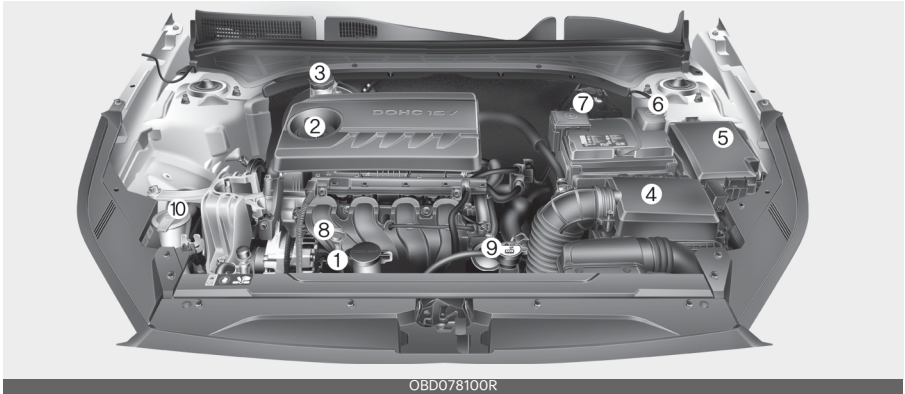

OBD078100R

(Petrol) 2.0 MPI

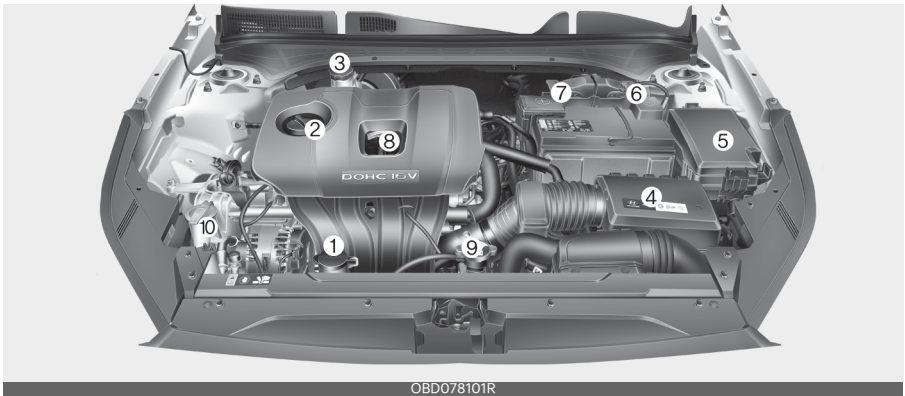

OBD078101R

* The actual engine room in the vehicle may differ from the illustration.

1. Engine coolant reservoir	8-41
2. Engine oil filler cap	8-38
3. Brake / clutch fluid reservoir	8-45
4. Air cleaner	8-47
5. Fuse box	8-63
6. Negative battery terminal	8-52
7. Positive battery terminal	8-52
8. Engine oil dipstick	8-38
9. Radiator cap	8-41
10. Windscreen washer fluid reservoir	8-46

(Petrol) 1.6 T-GDi

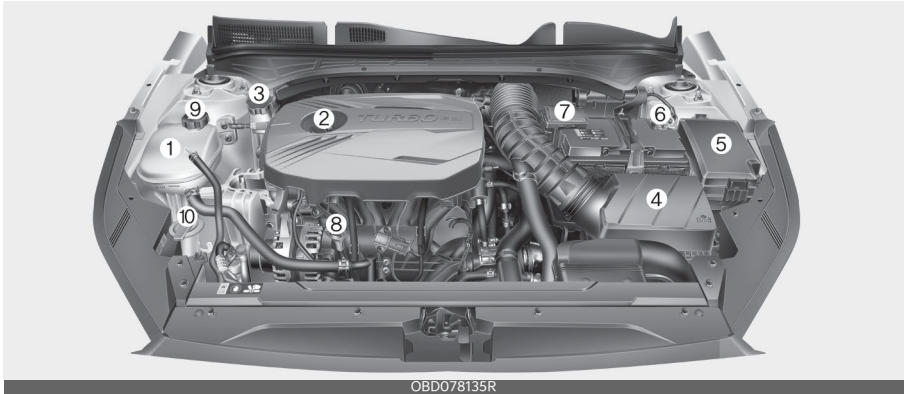

Smartstream G1.6

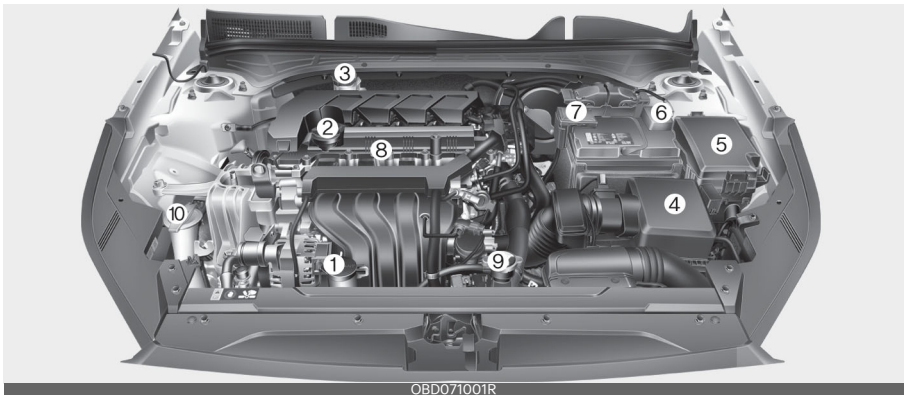

* The actual engine room in the vehicle may differ from the illustration.

- | | |
|---------------------------------------|------|
| 1. Engine coolant reservoir | 8-41 |
| 2. Engine oil filler cap | 8-38 |
| 3. Brake / clutch fluid reservoir | 8-45 |
| 4. Air cleaner | 8-47 |
| 5. Fuse box | 8-63 |
| 6. Negative battery terminal | 8-52 |
| 7. Positive battery terminal | 8-52 |
| 8. Engine oil dipstick | 8-38 |
| 9. Radiator cap | 8-41 |
| 10. Windscreen washer fluid reservoir | 8-46 |

Safety features of your vehicle **3**

Seats	3-3
• Driver’s seat.....	3-3
• Front passenger’s seat	3-3
• Rear seat.....	3-3
• Front seat adjustment - manual.....	3-6
• Front seat adjustment - power	3-7
• Driver position memory system (if equipped, for power seat)....	3-8
• Headrest (for front seat)	3-9
• Seatback pocket.....	3-12
• Rear seat adjustment	3-12
Seat belts	3-16
• Seat belt restraint system.....	3-16
• Pre-tensioner seat belt	3-23
• Seat belt precautions.....	3-25
• Care of seat belts	3-27
Child restraint system (CRS)	3-28
• Our recommendation: Children always in the rear	3-28
• Selecting a Child Restraint System (CRS)	3-29
• Installing a Child Restraint System (CRS).....	3-30
• ISOFIX anchorage and top-tether anchorage (ISOFIX anchorage system) for children.....	3-31
• Securing a Child Restraint System with a lap/shoulder belt.....	3-34
• Suitability of each seating position for Belted & ISOFIX Child Restraint Systems according to UN regulations (For Europe) ...	3-36
• Suitability of each seating position for Belted & ISOFIX Child Restraint Systems according to UN regulations (Except Europe) .	3-37
• Suitability of each seating position for belted & ISOFIX Child Restraint Systems (CRS) according to UN regulations (For Australia)	3-38
Air bag - supplemental restraint system	3-40

3 Safety features of your vehicle

- How does the air bag system operate 3-41
- Air bag warning light.....3-43
- SRS components and functions3-45
- Driver's and passenger's front air bag3-47
- Side air bag.....3-51
- Curtain air bag3-53
- Inflation and non-inflation conditions of the airbag.....3-54
- Air bag collision sensors3-55
- SRS Care3-59
- Additional safety precautions.....3-59
- Adding equipment to or modifying your air bag-equipped vehicle
3-60
- Air bag warning label3-61

Safety features of your vehicle

Seats

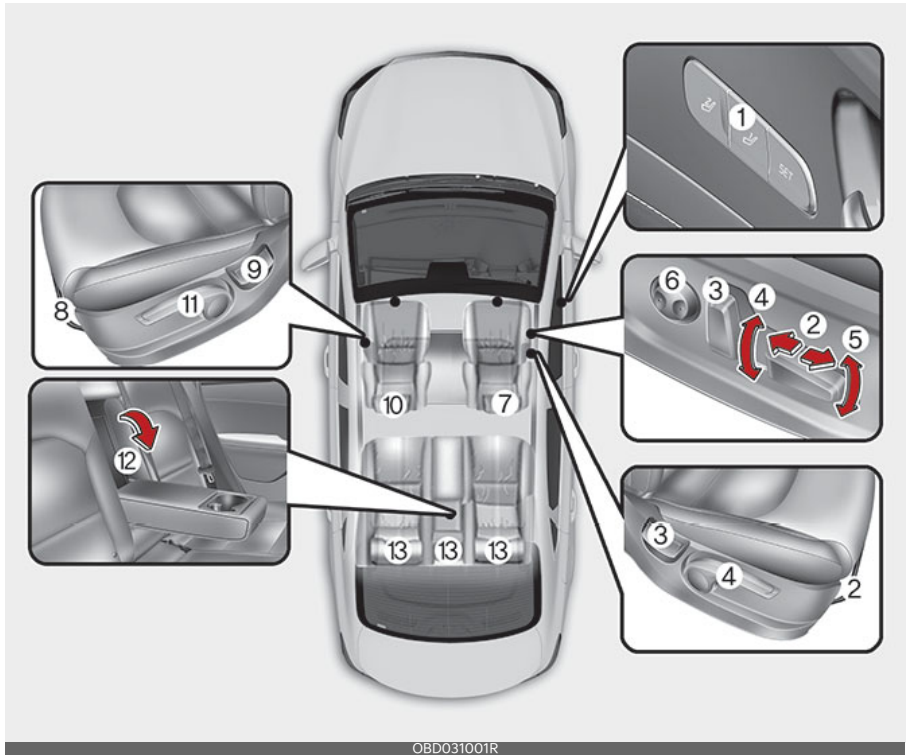

Driver's seat

1. Driver position memory system*
2. Forward and backward
3. Seatback angle
4. Seat cushion height
5. Seat cushion tilt *
6. Lumbar support *
7. Headrest

Front passenger's seat

8. Forward and backward
9. Seatback angle
10. Headrest
11. Seat cushion height

Rear seat

12. Armrest *
13. Headrest

* : if equipped

⚠ WARNING

Loose objects

Loose objects in the driver's foot area could interfere with the operation of the foot pedals, possibly causing an accident. Do not place anything under the front seats.

⚠ WARNING**Uprighting seat**

When you return the seatback to its upright position, hold the seatback and return it slowly and be sure there are no other occupants around the seat. If the seatback is returned without being held and controlled, the back of the seat could spring forward resulting in accidental injury to a person struck by the seatback.

⚠ WARNING**Driver responsibility for passengers**

Riding in a vehicle with the seatback reclined could lead to serious or fatal injury in an accident. If a seat is reclined during an accident, the occupant's hips may slide under the lap portion of the seat belt applying great force to the unprotected abdomen. Serious or fatal internal injuries could result. The driver must advise the passenger to keep the seatback in an upright position whenever the vehicle is in motion.

⚠ WARNING

Do not use a sitting cushion that reduces friction between the seat and passenger. The passenger's hips may slide under the lap portion of the seat belt during an accident or a sudden stop. Serious or fatal internal injuries could result because the seat belt cannot operate normally.

⚠ WARNING**Driver's seat**

- Never attempt to adjust the seat whilst the vehicle is moving. This could result in loss of control, and an

accident causing death, serious injury, or property damage.

- Do not allow anything to interfere with the normal position of the seatback. Storing items against a seatback or in any other way interfering with proper locking of a seatback could result in serious or fatal injury in a sudden stop or collision.
- Always drive and ride with your seatback upright and the lap portion of the seat belt snug and low across the hips. This is the best position to protect you in case of an accident.
- In order to avoid unnecessary and perhaps severe air bag injuries, always sit as far back as possible from the steering wheel whilst maintaining comfortable control of the vehicle. We recommend that your chest be at least 25 cm (10 inches) away from the steering wheel.

⚠ WARNING**Rear seatbacks**

- The rear seatback must be securely latched. If not, passengers and objects could be thrown forward resulting in serious injury or death in the event of a sudden stop or collision.
- Luggage and other cargo should be laid flat in the cargo area. If objects are large, heavy, or must be piled, they must be secured.

Under no circumstances should cargo be piled higher than the seatbacks. Failure to follow these warnings could result in serious injury or death in the event of a sudden stop, collision or rollover.

- No passenger should ride in the cargo area or sit or lie on folded seatbacks whilst the vehicle is moving. All pas-

sengers must be properly seated in seats and restrained properly whilst riding.

- When resetting the seatback to the upright position, make sure it is securely latched by pushing it forward and backwards.
- To avoid the possibility of burns, do not remove the carpet in the cargo area.
Emission control devices beneath this floor generate high temperatures.

⚠ WARNING

After adjusting the seat, always check that it is securely locked into place by attempting to move the seat forward or backward without using the lock release lever. Sudden or unexpected movement of the driver's seat could cause you to lose control of the vehicle resulting in an accident.

⚠ WARNING

- Do not adjust the seat whilst wearing seat belts. Moving the seat cushion forward may cause strong pressure on the abdomen.
- Use extreme caution so that hands or other objects are not caught in the seat mechanisms whilst the seat is moving.
- Do not put a cigarette lighter on the floor or seat. When you operate the seat, gas may gush out of the lighter and cause fire.
- If there are occupants in the rear seats, be careful whilst adjusting the front seat position.
- Use extreme caution when picking small objects trapped under the seats or between the seat and the centre

console. Your hands might be cut or injured by the sharp edges of the seat mechanism.

⚠ CAUTION

Precautions with seat covers

- Use caution when working on the seat cover. A short circuit or disconnection may occur, which could lead to noise, damage the ventilation system, and possible fire.
- Be aware of wires or air vents when placing a seat cover or covering the seat with plastic cover. A short circuit may occur, which could lead to fire.

Feature of Seat Leather

- Our car seats are upholstered with a combination of artificial and genuine leather. The genuine leather is made from the outer skin of an animal, which goes through a special process to be available for use. Since it is a natural substance, each part differs in thickness or density. Also, wrinkles could appear depending on the temperature and humidity.
- The seat cover is made of stretchable material to improve comfort of passengers.
- The parts contacting the body are curved and the side supporting area is high which provides driving comfort and stability.
- Wrinkles may appear naturally from usage. It is not a fault of the product.

⚠ CAUTION

- Wrinkles or abrasions which appear naturally from usage are not covered by warranty.

- Belts with metallic accessories, zippers or keys inside the back pocket may damage the seat fabric.
- Make sure not to wet the seat. It may change the nature of leather.
- Jeans or clothes which could bleach may contaminate the surface of the seat covering fabric.

Front seat adjustment - manual Forward and backward

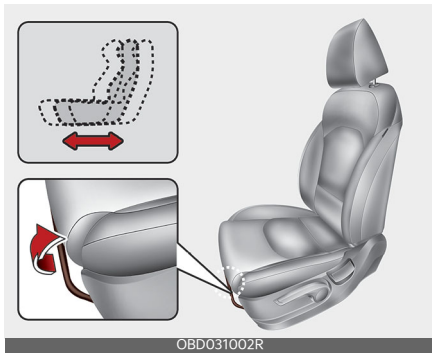

To move the seat forward or backward:

1. Pull the seat slide adjustment lever up and hold it.
2. Slide the seat to the position you desire.
3. Release the lever and make sure the seat is locked in place.

Adjust the seat before driving, and make sure the seat is locked securely by trying to move forward and backward without using the lever. If the seat moves, it is not locked properly.

Seatback angle

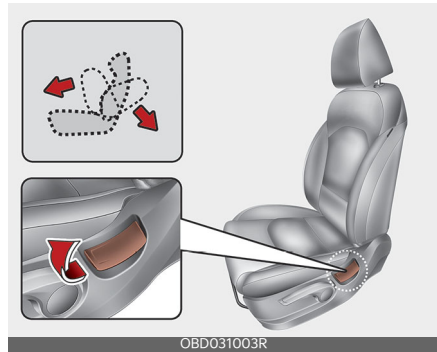

To recline the seatback:

1. Lean forward slightly and lift up the seatback recline lever.
2. Carefully lean back on the seat and adjust the seatback of the seat to the position you desire.
3. Release the lever and make sure the seatback is locked in place. (The lever **MUST** return to its original position for the seatback to lock.)

Seat height (if equipped)

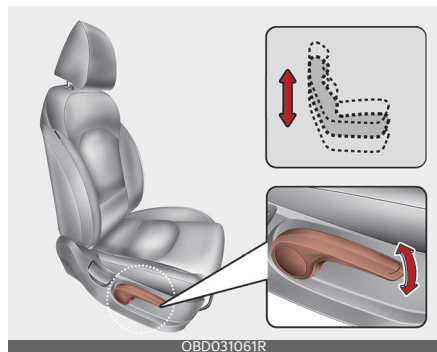

To change the height of the seat, push the lever upwards or downwards.

- To lower the seat cushion, push the lever down several times.
- To raise the seat cushion, pull the lever up several times.

Front seat adjustment - power (if equipped)

The front seat can be adjusted by using the control switches located on the outside of the seat cushion. Before driving, adjust the seat to the proper position so you can easily control the steering wheel, pedals and switches on the instrument panel.

⚠ CAUTION

The power seat is operable with the ignition switch or the ENGINE START/STOP button in OFF.

Therefore, children should never be left unattended in the vehicle.

⚠ CAUTION

- The power seat is driven by an electric motor. Stop operating once the adjustment is completed. Excessive operation may damage the electrical equipment.
- When in operation, the power seat consumes a large amount of electrical power. To prevent unnecessary charging system drain, don't adjust the power seat longer than necessary whilst the engine is not running.
- Do not operate two or more power seat control switches at the same time. Doing so may result in power seat motor or electrical component malfunction.

Forward and backward

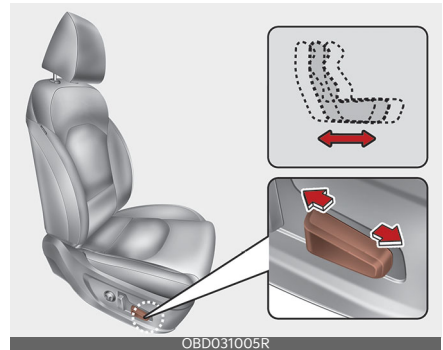

Push the control switch forward or backward to move the seat to the desired position. Release the switch once the seat reaches the desired position.

Seatback angle

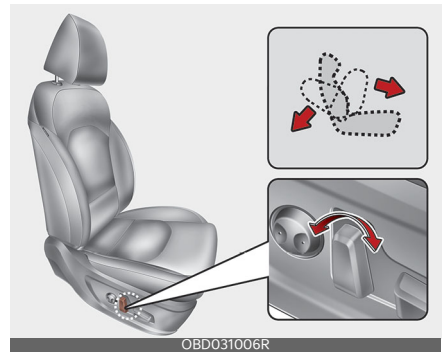

Push the control switch forward or backward to move the seatback to the desired angle. Release the switch once the seat reaches the desired position.

Seat height

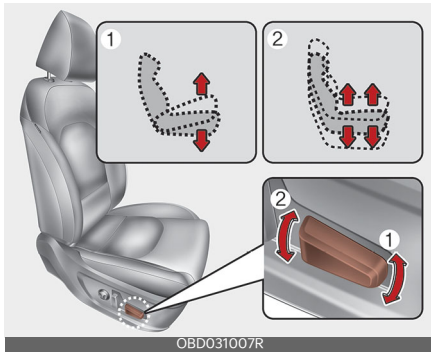

Pull the front portion of the control switch up to raise or press down to lower the front part of the seat cushion. Pull the rear portion of the control switch up to raise or press down to lower the seat cushion. Release the switch once the seat reaches the desired position.

Lumbar support

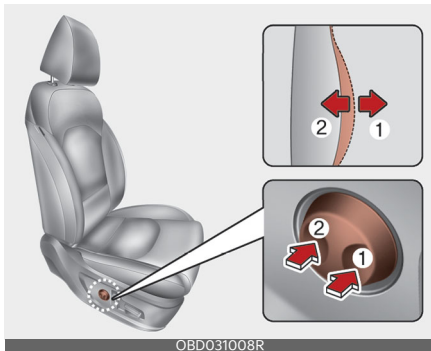

The lumbar support can be adjusted by pressing the lumbar support switch on the side of the seat.

1. Press the front portion (1) of the switch to increase support, or the rear portion (2) of the switch, to decrease support.
2. Release the switch once it reaches the desired position.

Driver position memory system (if equipped, for power seat)



A driver position memory system is provided to store and recall the driver seat with a simple button operation. By saving the desired position into the system memory, different drivers can reposition the driver seat based upon their driving preference. If the battery is disconnected, the position memory will be erased and the driving position should be restored in the system.

⚠ WARNING

Never attempt to operate the driver position memory system whilst the vehicle is moving.

This could result in loss of control, and an accident causing death, serious injury, or property damage.

Storing positions into memory using the buttons on the door

Storing driver's seat positions

1. Shift the shift lever into P (for Automatic transmission / Dual clutch transmission/ Intelligent Variable Transmission) or Neutral (for manual transmission) whilst the ENGINE

START/STOP button is ON or ignition switch ON.

2. Press SET button on the control panel. The system will beep once.
3. Press one of the memory buttons (1 or 2) within 5 seconds after pressing the SET button. The system will beep twice when memory has been successfully stored.

Recalling positions from memory

1. Shift the shift lever into P (for Automatic transmission / Dual clutch transmission/ Intelligent Variable Transmission) or Neutral (for manual transmission) whilst the ENGINE START/STOP button is ON or ignition switch ON.
2. To recall the position in the memory, press the desired memory button (1 or 2). The system will beep once, then the driver's seat will automatically adjust to the stored position.

Adjusting the control switch for the driver's seat whilst the system is recalling the stored position will cause the movement to stop and move in the direction that the control switch is moved.

WARNING

Use caution when recalling the adjustment memory whilst sitting in the vehicle. Push the seat position control switch to the desired position immediately if the seat moves too far in any direction.

Easy access function (if equipped)

The system will move the driver's seat automatically as follows:

- Without smart key system

- It will move the driver's seat rearward when the ignition key is removed and front driver's door is opened.
- It will move the driver's seat forward when the ignition key is inserted.
- With smart key system
 - It will move the driver's seat rearward when the ENGINE START/STOP button is changed to the OFF position and front driver's door is opened.
 - It will move the driver's seat forward when the ENGINE START/STOP button is changed to the ACC or START position.
 - It will move the driver's seat forward when you get in your vehicle with the smart key after closing the driver's door. You can activate or deactivate this feature. Refer to "User settings mode (if equipped)" on page 4-64.

Headrest (for front seat)

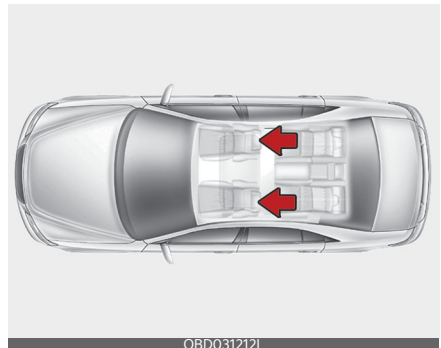

The driver's and front passenger's seats are equipped with a headrest for the occupant's safety and comfort.

The headrest not only provides comfort for the driver and front passenger, but

also helps protect the head and neck in the event of a collision.

⚠ WARNING

- For maximum effectiveness in case of an accident, the headrest should be adjusted so the middle of the headrest is at the same height of the centre of gravity of an occupant's head. Generally, the centre of gravity of most people's head is similar with the height of the top of their eyes. Also, adjust the headrest as close to your head as possible. For this reason, the use of a cushion that holds the body away from the seatback is not recommended.
- Do not operate the vehicle with the headrests removed. Severe injury to the occupants may occur in the event of an accident. Headrests may provide protection against neck injuries when properly adjusted.
- Do not adjust the headrest position of the driver's seat whilst the vehicle is in motion.

Forward and rearward adjustment (if equipped)



The headrest may be adjusted forward to 3 different positions by pulling the

headrest forward to the desired detent. To adjust the headrest to its furthest rearwards position, pull it fully forward to the farthest position and release it.

Adjusting the height up and down

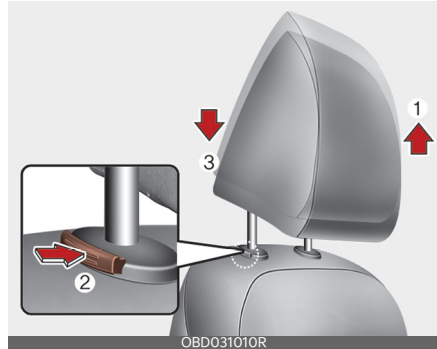

To raise the headrest, pull it up to the desired position (1). To lower the headrest, push and hold the release button (2) and lower the headrest to the desired position (3).

⚠ CAUTION

If you recline the seatback towards the front with the headrest and seat cushion raised, the headrest may come in contact with the sunvisor or other parts of the vehicle.



Removal/Reinstall

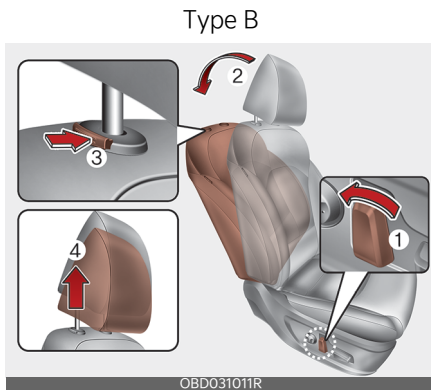
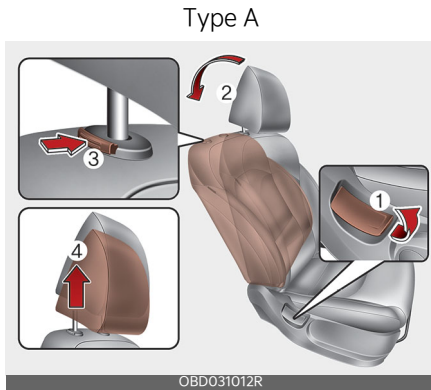

To remove the headrest:

1. Recline the seatback (2) with the recline lever or switch (1).
2. Raise headrest as far as it can go.
3. Press the headrest release button (3) whilst pulling the headrest up (4).

⚠ WARNING

NEVER allow anyone to ride in a seat with the headrest removed.

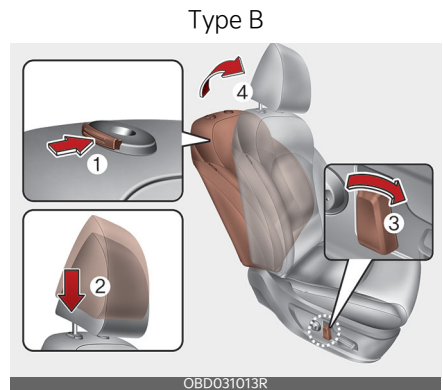
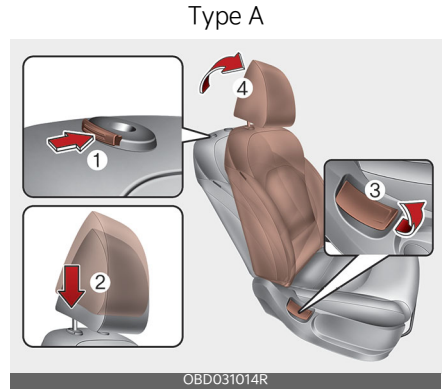

To reinstall the headrest:

1. Put the headrest poles (2) into the holes whilst pressing the release button or switch (1).
2. Recline the seatback(4) with the recline lever or switch (3).
3. Adjust the headrest to the appropriate height.

⚠ WARNING

Always make sure the headrest locks into position after reinstalling and adjusting it properly.

Seatback pocket (if equipped)

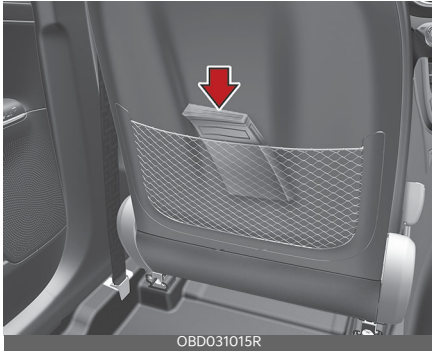

The seatback pocket is provided on the back of the front passenger's seatbacks.

⚠ WARNING

Seatback pockets

Do not put heavy or sharp objects in the seatback pockets. In an accident they could come loose from the pocket and injure vehicle occupants.

Rear seat adjustment

Headrest (if equipped)

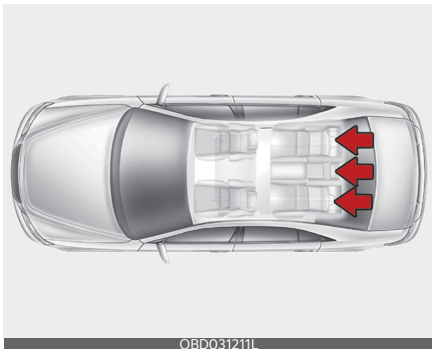

The rear seat is equipped with headrests for the occupant's safety and comfort.

The headrest not only provides comfort for passengers, but also helps to protect

the head and neck in the event of a collision.

⚠ WARNING

- For maximum effectiveness in case of an accident, the headrest should be adjusted so the middle of the headrest is at the same height of the centre of gravity of an occupant's head. Generally, the centre of gravity of most people's head is similar with the height of the top of their eyes. Also adjust the headrest as close to your head as possible. For this reason, the use of a cushion that holds the body away from the seatback is not recommended.
- Do not operate the vehicle with the headrests removed. Severe injury to an occupant may occur in the event of an accident. Headrests may provide protection against severe neck injuries when properly adjusted.

Adjusting the height up and down

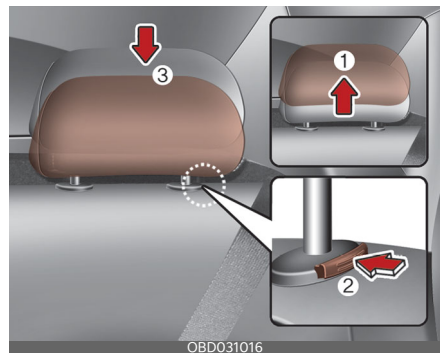

To raise the headrest, pull it up to the desired position (1). To lower the headrest, push and hold the release button (2) on the headrest support and lower the headrest to the desired position (3).

⚠ CAUTION

When there is no occupant in the rear seats, adjust the height of the headrest to the lowest position. The rear seat headrest can reduce the visibility of the rear area.

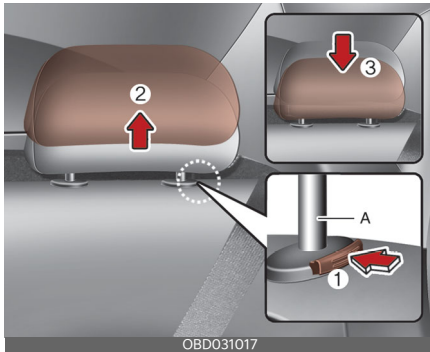
Removal and installation (if equipped)

To remove the headrest, raise it as far as it can go then press the release button (1) whilst pulling upward (2).

To reinstall the headrest, put the headrest poles (A) into the holes whilst pressing the release button (1). Then adjust it to the appropriate height.

⚠ CAUTION

Make sure the headrest locks in position after adjusting it to properly protect the occupants.

Armrest

To use the armrest, pull it forward from the seatback.

Folding the rear seat

The rear seatbacks may be folded to facilitate carrying long items or to increase the luggage capacity of the vehicle.

⚠ WARNING

The purpose of the fold-down rear seatbacks is to allow you to carry longer objects than could not otherwise be accommodated.

Never allow passengers to sit on top of the folded down seatback whilst the car is moving as this is not a proper seating position and no seat belts are available for use. This could result in serious injury or death in case of an accident or sudden stop. Objects carried on the folded down seatback should not extend higher than the top of the front seats. This could allow cargo to slide forward and cause injury or damage during sudden stops.

To fold down the rear seatback (4 Door):

1. Set the front seatback to the upright position and if necessary, slide the front seat forward.
2. Lower the rear headrests to the lowest position.



3. Pull out the seatback locking knob(1) in the trunk, then fold the seat toward the front of the vehicle.
4. To use the rear seat, lift and push the seatback backward. Push the seat back firmly until it clicks into place. Make sure the seatback is locked in place.
5. Return the rear seat belt to the proper position.

To fold down the rear seatback (5 Door):

1. Set the front seatback to the upright position and if necessary, slide the front seat forward.
2. Lower the rear headrests to the lowest position.

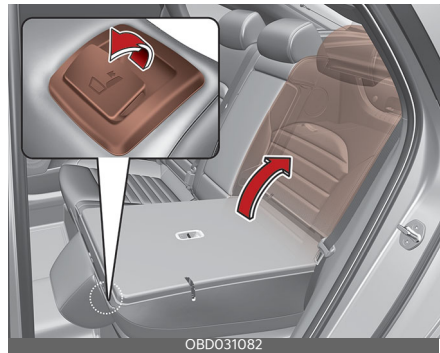
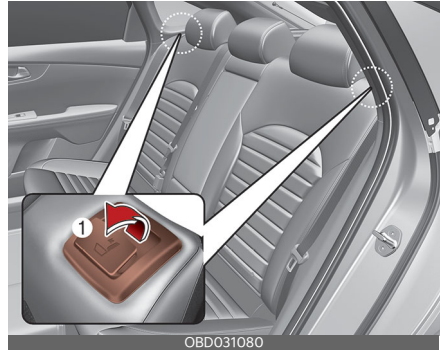

3. On rear outboard seatback: Pull the lock release lever (1) and fold the rear seatback forward and down firmly.
4. To use the rear seat, lift and pull the seatback backward. Pull the seatback firmly until it clicks into place. Make sure the seatback is locked in place.
5. Return the rear seat belt to the proper position.

⚠ WARNING

After folding the rear seat, unless the driver's position is properly set according to the driver's physical figure, do not fold the rear seat. It may increase body injuries in a sudden stop or collision.

⚠ WARNING**Uprighting seat**

When you return the seatback to its upright position, hold the seatback and return it slowly. If the seatback is returned without holding it, the back of the seat could spring forward resulting in injury caused by being struck by the seatback.

⚠ WARNING

When you return the rear seatback to its upright position after being folded down:

Be careful not to damage the seat belt webbing or buckle. Do not allow the seat belt webbing or buckle to get caught or pinched in the rear seat. Ensure that the seatback is completely locked into its upright position by pushing on the top of the seatback. Otherwise, in an accident or sudden stop, the seat could fold down and allow cargo enter the passenger compartment, which could result in serious injury or death.

⚠ CAUTION**Damaging rear seat belt buckles**

When you fold the rear seatback, insert the buckle between the rear seatback and cushion. Doing so can prevent the buckle from being damaged by the rear seatback.

⚠ CAUTION**Rear seat belts**

When returning the rear seatbacks to the upright position, remember to return the rear shoulder belts to their proper position.

⚠ WARNING**Cargo**

Cargo should always be secured to prevent it from being thrown about the vehicle in a collision and causing injury to the vehicle occupants. Do not place objects in the rear seats, since they cannot be properly secured and may hit the front seat occupants in a collision.

⚠ WARNING**Cargo loading**

Make sure the engine is off, the automatic transmission is in P (Park), and the parking brake is securely applied whenever loading or unloading cargo. Failure to take these steps may allow the vehicle to move if the shift lever is inadvertently moved to another position.

Seat belts

Seat belt restraint system

WARNING

- For maximum restraint system protection, the seat belts must always be used whenever the vehicle is moving.
- Seat belts are most effective when seatbacks are in the upright position.
- Children age 13 and under must always be properly restrained in the rear seat. Never allow children to ride in the front passenger seat. If a child over 13 must be seated in the front seat, he/she must be properly belted and the seat should be moved as far back as possible.
- Never wear the shoulder belt under your arm or behind your back. An improperly positioned shoulder belt can cause serious injuries in a crash. The shoulder belt should be positioned midway over your shoulder across your collarbone.
- Never wear a seat belt over fragile objects. If there is a sudden stop or impact, the seat belt can damage it.
- Avoid wearing twisted seat belts. A twisted belt can't do its job well. In a collision, it could even cut into you. Be sure the belt webbing is straight and not twisted.
- Be careful not to damage the belt webbing or hardware. If the belt webbing or hardware is damaged, replace it.

WARNING

Australian design rules

Seat belts are designed to bear upon the bony structure of the body, and should be worn low across the front of the pel-

vis or the pelvis, chest and shoulders, as applicable; wearing the lap section of the belt across the abdominal area must be avoided.

Seat belts should be adjusted as firmly as possible, consistent with comfort, to provide the protection for which they have been designed.

A slack belt will greatly reduce the protection afforded to the wearer.

Care should be taken to avoid contamination of the webbing with polishes, oils and chemicals, and particularly battery acid.

Cleaning may safely be carried out using mild soap and water. The belt should be replaced if webbing becomes frayed, contaminated or damaged.

It is essential to replace the entire assembly after it has been worn in a severe impact even if damage to the assembly is not obvious. Belts should not be worn with straps twisted. Each belt assembly must only be used by one occupant; it is dangerous to put a belt around a child being carried on the occupant's lap.

WARNING

Australian design rules

- No modifications or additions should be made by the user which will either prevent the seat belt adjusting devices from operating to remove slack, or prevent the seat belt assembly from being adjusted to remove slack.
- When you fasten the seat belt, be careful not to latch the seat belt in buckles of other seat. It's very dangerous and you may not be protected by the seat belt properly.

- Do not unfasten the seat belt and do not fasten and unfasten the seat belt repeatedly whilst driving. This could result in loss of control, and an accident causing death, serious injury, or property damage.
- When fastening the seat belt, make sure that the seat belt does not pass over objects that are hard or can break easily.
- Make sure there is nothing in the buckle. The seat belt may not be fastened securely.

Driver's seat belt warning



As a reminder to the driver, the seat belt warning light will illuminate for approximately 6 seconds each time you turn the ignition switch or the ENGINE START/STOP button is in ON regardless of belt fastening and warning chime will sound for approximately 6 seconds each time you turn the ignition switch or the ENGINE START/STOP button is in ON when the belt is unfastened.

If a driver continue not to fasten the seat belt and drive below 20km/h, the warning light will stay illuminated.

If a driver continue not to fasten the seat belt whilst driving over 20km/h, the seat belt warning chime will sound for approximately 100 seconds and the corresponding warning light will blink.

If a driver unfasten the seat belt whilst driving below 20km/h, the warning light will stay illuminated.

If a driver unfasten the seat belt whilst driving over 20km/h, the seat belt warning chime will sound for approximately 100 seconds and the corresponding warning light will blink.

Front passenger's seat belt warning (if equipped)



As a reminder to the front passenger, the front passenger's seat belt warning lights will illuminate for approximately 6 seconds each time you turn the ignition switch or the ENGINE START/STOP button in ON regardless of belt fastening. If the front passenger continue not to fasten the seat belt and drive below 20km/h, the warning light will stay illuminated.

If the front passenger continue not to fasten the seat belt whilst driving over 20km/h, the seat belt warning chime will sound for approximately 100 seconds and the corresponding warning light will blink.

If the front passenger unfasten the seat belt whilst driving below 20km/h, the warning light will stay illuminated.

If the front passenger unfasten the seat belt whilst driving over 20km/h, the seat belt warning chime will sound for

approximately 100 seconds and the corresponding warning light will blink.

Rear passenger’s seat belt warning (if equipped)

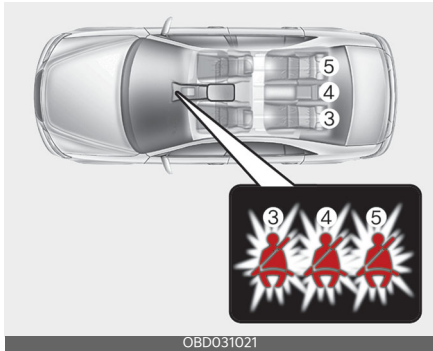

(For Australia)

As a reminder to the rear passenger, the rear passenger's seat belt warning lights will illuminate for approximately 6 seconds each time you turn the ignition switch or ENGINE START/STOP button in ON regardless of belt fastening. If the rear passenger continues not to fasten the seat belt and drive below 20 km/h, the warning light will stay illuminated. If the rear passenger continues not to fasten the seat belt whilst driving over 20 km/h, the seat belt warning chime will sound for approximately 35 seconds and the corresponding warning light will blink. If the rear passenger unfastens the seat belt whilst driving below 20 km/h, the warning light will stay illuminated. If the rear passenger unfastens the seat belt whilst driving over 20 km/h, the seat belt warning chime will sound for approximately 35 seconds and the corresponding warning light will blink.

(For Europe)

As a reminder to the rear passenger, if the seat belt is not fastened when the ignition switch or ENGINE START/STOP button is turned ON, the seat belt warning light will illuminate for approximately 70 seconds.

If the rear passenger continues not to fasten the seat belt and drive below 20 km/h, the corresponding warning light will continue to illuminate for approximately 70 seconds.

If the rear passenger continues not to fasten the seat belt whilst driving over 20 km/h, the seat belt warning light will illuminate for approximately 70 seconds.

If you unfasten the seat belt when you drive under 20 km/h, the corresponding warning light will continue to illuminate for approximately 70 seconds. If the rear passenger unfastens the seat belt whilst driving over 20 km/h, the seat belt warning chime will sound for approximately 35 seconds and the corresponding warning light will blink.

Lap/Shoulder belt

Height adjustment

Front seat

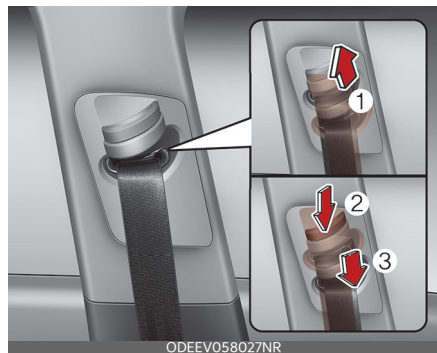

You can adjust the height of the shoulder belt anchor to maximum comfort and safety.

The height of the adjusting seat belt should not be too close to your neck. Otherwise, you will not be getting the most effective protection. The shoulder portion should be adjusted so that it lies across your chest and midway over your shoulder near the door and not your neck.

To adjust the height of the seat belt anchor, lower or raise the height adjuster into an appropriate position.

To raise the height adjuster, pull it up (1). To lower it, push it down (3) whilst pressing the height adjuster button (2).

Release the button to lock the anchor into position. Try sliding the height adjuster to make sure that it has locked into position.

Improperly positioned seat belts can cause serious injuries in an accident.

⚠ WARNING

- Verify the shoulder belt anchor is locked into position at the appropriate height. Never position the shoulder belt across your neck or face. Improperly positioned seat belts can cause serious injuries in an accident.
- After a collision, the seat belt system should be inspected to ensure it is operating normally. Replace any belts that are not functioning appropriately.

To fasten your seat belt:

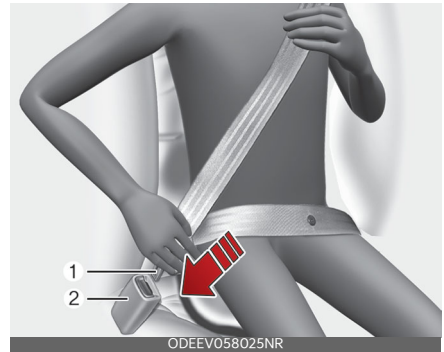

To fasten your seat belt, pull it out of the retractor and insert the metal tab (1) into the buckle (2). There will be an audible "click" when the tab locks into the buckle.

The seat belt automatically adjusts to the proper length only after the lap belt portion is adjusted manually so that it fits snugly around your hips. If you lean forward in a slow, easy motion, the belt will extend and let you move around. If there is a sudden stop or impact, however, the belt will lock into position. It will also lock if you try to lean forward too quickly.

*** NOTICE**

If you are not able to pull out the seat belt from the retractor, firmly pull the belt out and release it. Then you will be able to pull the belt out smoothly.

⚠ WARNING

You should place the lap belt portion as low as possible and snugly across your hips, not on your waist. If the lap belt is located too high on your waist, it may increase the chance of injury in the event of a collision. Both arms should not be under or over the belt. Rather,

one should be over and the other under, as shown in the illustration.

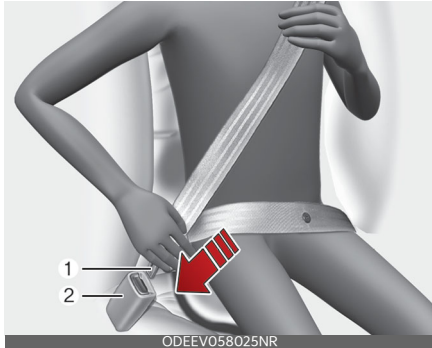

Never wear the seat belt under the arm near the door.

Pull the metal tab (B) and insert it (B) into the buckle (B'). There will be an audible "click" when the tab locks into the buckle. Make sure the belt is not twisted.

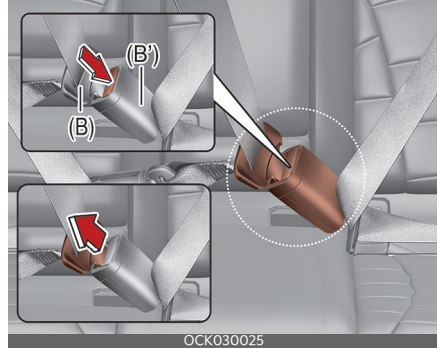
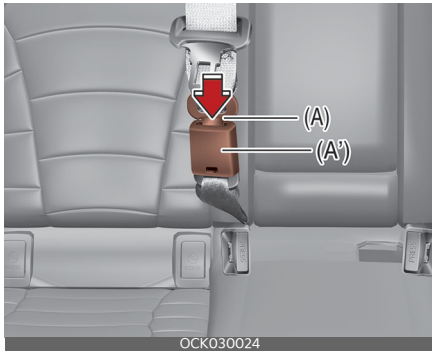

When using the rear centre seat belt the buckle with the "CENTER" mark must be used.

⚠ WARNING

Always have the mini metal tab(A) inserted into the mini buckle (A').

*** NOTICE**

If you are not able to pull out the safe-ty belt from the retractor, firmly pull the belt out and release it. After release, you will be able to pull the belt out smoothly.

To release the seat belt:

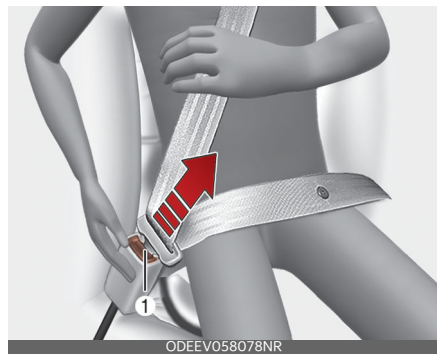

The seat belt is released by pressing the release button (1) in the locking buckle.

When it is released, the belt should automatically draw back into the retractor. If this does not happen, check the belt to be sure it is not twisted, then try again.

4Door

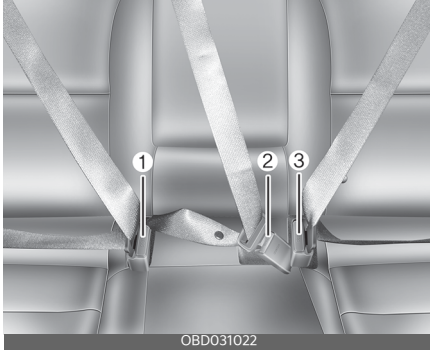

5Door

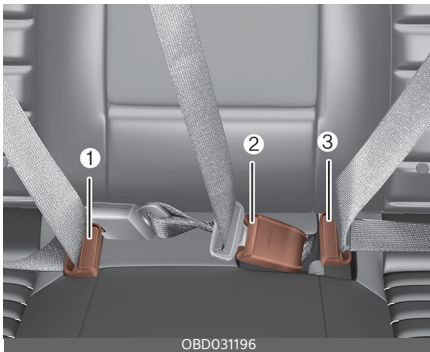

The seat belt should be locked into the buckle on each seat cushion to be properly fastened.

- (1) : Rear right seat belt fastening buckle
- (2) : Rear centre seat belt fastening buckle
- (3) : Rear left seat belt fastening buckle

4Door



5Door

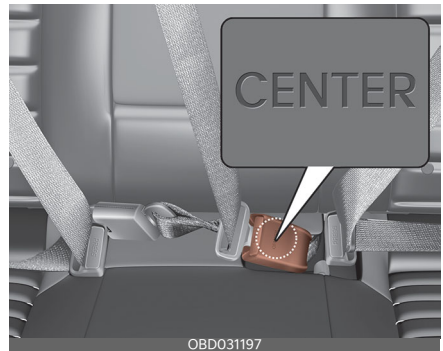

When using the rear centre seat belt, the buckle with the "CENTER" mark must be used.

⚠ CAUTION

Do not force to lock the left or right seat belt into the centre seat belt buckle.

Make sure to lock the rear center seat belt into the centre seat belt buckle.

If not, the improperly fastened seat belt will not be able to provide protection.

Lap belt (if equipped)

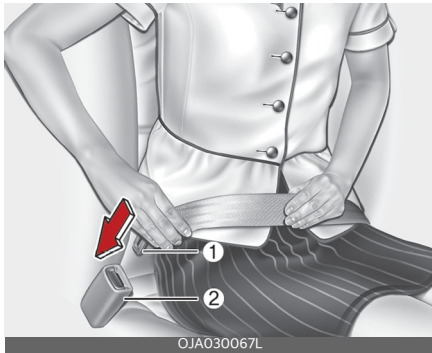

To fasten your seat belt:

To fasten a 2-point static type belt, insert the metal tab (1) into the locking buckle (2). There will be an audible "click" when the tab locks into the buckle. Check to make sure the belt is properly locked and that the belt is not twisted.

With a 2-point static type seat belt, the length must be adjusted manually so it fits snugly around your body. Fasten the belt and pull on the loose end to tighten. The belt should be placed as low as possible on your hips (1), not on your waist. If the belt is too high, it could increase the possibility of your being injured in an accident. When using the rear centre seat belt, the buckle with the "CENTER" mark must be used.

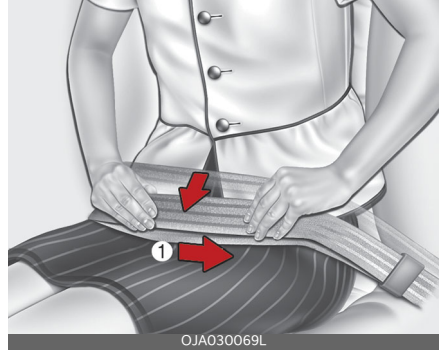
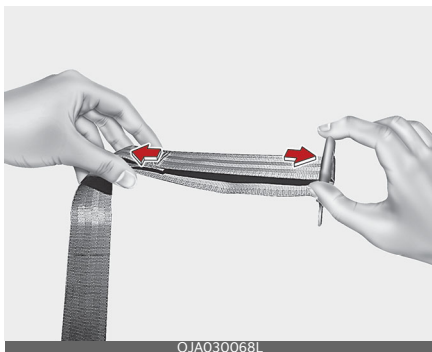

To release the seat belt:

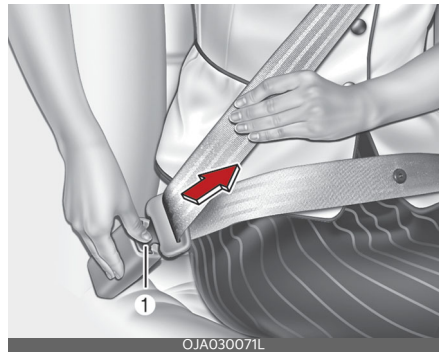

When you want to release the seat belt, press the button (1) in the locking Buckle.

⚠ WARNING

The centre lap belt latching mechanism is different from those for the rear seat shoulder belts. When fastening the rear seat shoulder belts or the centre lap belt, make sure they are inserted into the correct buckles to obtain maximum protection from the seat belt system and assure proper operation.

Pre-tensioner seat belt (if equipped)



Your vehicle is equipped with driver's and front passenger's pre-tensioner seat belts (retractor pretensioner).

The purpose of the pre-tensioner is to make sure that the seat belts fit tightly against the occupant's body in certain collisions. The pre-tensioner seat belts may be activated in crashes where the collision is severe enough.

Rear retractor pre-tensioner seat belts are equipped.

The pre-tensioner seat belts can be activated, where the frontal collision is severe enough, together with the air bags.

When the vehicle stops suddenly, or if the occupant tries to lean forward too quickly, the seat belt retractor will lock into position. In certain frontal collisions, the pre-tensioner will activate and pull the seat belt into tighter contact against the occupant's body.

If the system senses excessive tension on the driver or passenger's seat belt when the pre-tensioner system activates, the load limiter inside the retractor pre-tensioner will release some of the pressure on the affected seat belt. (if equipped)

* NOTICE

if equipped with rollover sensor

The pre-tensioner will activate not only in a frontal collision but also in a side collision or rollover, if the vehicle is equipped with a side or curtain air bag.

* NOTICE

without rollover sensor

The pre-tensioner will activate not only in a frontal collision but also in a side collision, if the vehicle is equipped with a side or curtain air bag.

⚠ WARNING

For your safety, be sure that the belt webbing is not loose or twisted and always sit properly on your seat.

* NOTICE

The pre-tensioner will activate not only in a frontal collision but also in a side collision, if the vehicle is equipped with a side or curtain air bag.

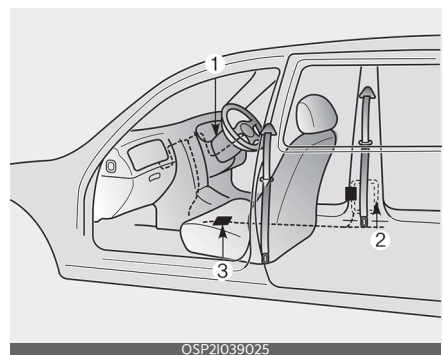

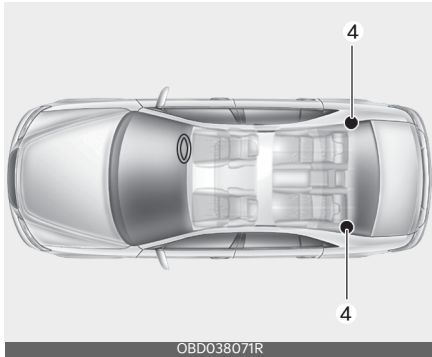

The seat belt pre-tensioner system consists mainly of the following components. Their locations are shown in the illustration:

1. SRS air bag warning light
2. Retractor pre-tensioner assembly
3. SRS control module
4. Rear retractor pre-tensioner assembly (if equipped)

⚠ WARNING

To obtain maximum benefit from a pre-tensioner seat belt:

1. The seatbelt must be worn correctly and adjusted to the proper position. Please read and follow all of the important information and precautions about your vehicle’s occupant safety features - including seat belts and air bags - that are provided in this manual.
2. Be sure you and your passengers always wear seat belts properly.

*** NOTICE**

- Pre-tensioner seat belts will be activated in certain frontal collisions. The pre-tensioner seat belts can be activated, where the frontal collision is

severe enough, together with the air bags.

- When the pre-tensioner seat belts are activated, a loud noise may be heard and fine dust, which may appear to be smoke, may be visible in the passenger compartment. These are normal operating conditions and are not hazardous.
- Although it is harmless, the fine dust may cause skin irritation and should not be breathed for prolonged periods. Wash all exposed skin areas thoroughly after an accident in which the pre-tensioner seat belts were activated.
- Because the sensor that activates the SRS air bag is connected with the pre-tensioner seat belt, the SRS air bag warning light on the instrument panel will illuminate for approximately 6 seconds after the ignition switch or the ENGINE START/STOP button has been turned to the "ON" position, and then it should turn off. on the instrument panel will illuminate for approximately 6 seconds after the ENGINE START/STOP button has been turned to the ON position, and then it should turn off.

⚠ CAUTION

If the pre-tensioner seat belt is not working properly, the SRS air bag warning light will illuminate even if there is no malfunction of the SRS air bag. If the SRS air bag warning light does not illuminate when the ignition switch or the ignition switch or the ENGINE START/STOP button is turned to ON, or if it remains illuminated after illuminating for approximately 6 seconds, or if it illuminates whilst the vehicle is being driven,

have the system inspected by a professional workshop. Kia recommends to visit an authorised Kia dealer/service partner.

WARNING

- Pre-tensioners are designed to operate only one time. After activation, pre-tensioner seat belts must be replaced. All seat belts of any type should always be replaced after they have been worn during a collision.
- The pre-tensioner seat belt assembly mechanisms become hot during activation. Do not touch the pre-tensioner seat belt assemblies for several minutes after they have been activated.
- Do not attempt to inspect or replace the pre-tensioner seat belts yourself. Have the system inspected by a professional workshop. Kia recommends to visit an authorised Kia dealer/service partner.
- Do not strike the pre-tensioner seat belt assemblies.
- Do not attempt to service or repair the pre-tensioner seat belt system in any manner.
- Improper handling of the pretensioner seat belt assemblies, and failure to heed the warnings not to strike, modify, inspect, replace, service or repair the pre-tensioner seat belt assemblies may lead to improper operation or inadvertent activation and serious injury.
- Always wear the seat belts when driving or riding in a motor vehicle.
- If the vehicle or pre-tensioner seat belt must be discarded, contact a professional workshop. Kia recommends

to contact an authorised Kia dealer/service partner.

CAUTION

Body work on the front area of the vehicle may damage the pretensioner seat belt system. Therefore, have the system serviced by a professional workshop. Kia recommends to visit an authorised Kia dealer/service partner.

Seat belt precautions

WARNING

All occupants of the vehicle must wear their seat belts at all times. Seat belts and child restraints reduce the risk of serious or fatal injuries for all occupants in the event of a collision or sudden stop. Without a seat belt, occupants could be shifted too close to a deploying air bag, strike the interior structure or be thrown from the vehicle. Properly worn seat belts greatly reduce these hazards. Always follow the precautions about seat belts, air bags and occupant seating contained in this manual. Never wear a seat belt over fragile objects. If there is a sudden stop or impact, the seat belt can damage it.

Infant or small child

You should be aware of the specific requirements in your country. Child and/or infant seats must be properly placed and installed in the rear seat. For more information about the use of these restraints, refer to "Child restraint system (CRS)" on page 3-28.

⚠ WARNING

Every person and animal in your vehicle needs to be properly restrained at all times, including infants and children. Never hold a child in your arms or lap when riding in a vehicle. The violent forces created during a crash will tear the child from your arms and throw the child against the interior. Always use a child restraint appropriate for your child's height and weight.

*** NOTICE**

Small children are best protected from injury in an accident when properly restrained in the rear seat by a child restraint system that meets the requirements of the Safety Standards of your country. Before buying any child restraint system, make sure that it has a label certifying that it meets Safety Standards of your country. The restraint must be appropriate for your child's height and weight. Check the label on the child restraint for this information. Refer to "Child restraint system (CRS)" on page 3-28.

Larger children

Children who are too large for child restraint systems should always occupy the rear seat and use the available lap/shoulder belts. The lap portion should be fastened and snugged on the hips and as low as possible. Check if the belt fits periodically. A child's squirming could put the belt out of position. Children are given the most safety in the event of an accident when they are restrained by a proper restraint system in the rear seat. If a larger child (over age 13) must be seated in the front seat, the child should

be securely restrained by the available lap/shoulder belt and the seat should be placed in the rearmost position. Children age 13 and under should be restrained securely in the rear seat. NEVER place a child age 13 and under in the front seat. NEVER place a rear facing child seat in the front seat of a vehicle.

If the shoulder belt portion slightly touches the child's neck or face, try placing the child closer to the centre of the vehicle. If the shoulder belt still touches their face or neck they need to be returned to a child restraint system.

⚠ WARNING**Shoulder belts on small children**

- Never allow a shoulder belt to be in contact with a child's neck or face whilst the vehicle is in motion.
- If seat belts are not properly worn and adjusted on children, there is a risk of death or serious injury.

Pregnant women

The use of a seat belt is recommended for pregnant women to lessen the chance of injury in an accident. When a seat belt is used, the lap belt portion should be placed as low and securely as possible on the hips, not across the abdomen. For specific recommendations, consult a physician or doctor.

⚠ WARNING**Pregnant women**

Pregnant women must never place the lap portion of the safety belt over the area of the abdomen where the fetus is located or above the abdomen where the belt could crush the fetus during an impact.

Injured person

A seat belt should be used when an injured person is being transported. When this is necessary, you should consult a physician for recommendations.

One person per belt

Two people (including children) should never attempt to use a single seat belt. This could increase the severity of injuries in case of an accident.

Do not lie down

To reduce the chance of injuries in the event of an accident and to achieve maximum effectiveness of the restraint system, all passengers should be sitting up and the front and rear seats should be in an upright position when the vehicle is moving. A seat belt cannot provide proper protection if the person is lying down in the rear seat or if the front and rear seats are in a reclined position.

WARNING

Riding with a reclined seatback increases your chance of serious or fatal injuries in the event of a collision or sudden stop. The protection of your restraint system (seat belts and air bags) is greatly reduced by reclining your seat. Seat belts must be secured against your hips and chest to work properly. The more the seatback is reclined, the greater the chance an occupant's hips will slide under the lap belt causing serious internal injuries. Also, the shoulder belt may strike the occupant's neck. Drivers and passengers should always sit well back in their seats, properly belted, and with the seatbacks upright.

Care of seat belts

Seat belt systems should never be disassembled or modified. In addition, care should be taken to assure that seat belts and belt hardware are not damaged by seat hinges, doors or other abuse.

WARNING

- When you return the rear seatback to its upright position after the rear seatback has been folded down, be careful not to damage the seat belt webbing or buckle. Be sure that the webbing or buckle does not get caught or pinched in the rear seat. A seat belt with damaged webbing or buckle could possibly fail during a collision or sudden stop, resulting in serious injury. If the webbing or buckles are damaged, get them replaced immediately.
- Seatbelts can become hot in a vehicle that has been closed up in sunny weather. They could burn infants and children.

Periodic inspection

All seat belts should be inspected periodically for wear or damage of any kind. Any damaged parts should be replaced as soon as possible.

Keep belts clean and dry

Seat belts should be kept clean and dry. If belts become dirty, they can be cleaned by using a mild soap solution and warm water. Bleach, dye, strong detergents or abrasives should not be used because they may damage and weaken the fabric.

When to replace seat belts

Entire in-use seat belt assembly or assemblies should be replaced if the vehicle has been involved in an accident. This should be done even if no damage is visible. In this case, have the system replaced by a professional workshop. Kia recommends to consult an authorised Kia dealer/service partner.

Child restraint system (CRS)

Our recommendation: Children always in the rear

WARNING

Always properly restrain children in the vehicle. Children of all ages are safer when riding in the rear seats. Never place a rearward-facing Child Restraint System on the front passenger seat, unless the air bag is deactivated.

Children under age 13 should always ride in the rear seats and must always be properly restrained to minimise the risk of injury in an accident, sudden stop or sudden manoeuvre.

According to accident statistics, children are safer when properly restrained in the rear seats than in the front seat. Children too large for a Child Restraint System must use the seat belts provided.

Most countries have regulations which require children to travel in approved Child Restraint Systems.

The laws governing the age or height/weight restrictions at which seat belts can be used instead of Child Restraint System differs among countries, so you should be aware of the specific requirements in your country, and where you are travelling.

Child Restraint Systems must be properly installed in the vehicle seat. Always use a commercially available Child Restraint System that meets the requirements of your country.

Child Restraint System (CRS)

Infants and younger children must be restrained in an appropriate rearward-facing or forward-facing CRS that has first been properly secured to the seat of

the vehicle. Read and comply with the instructions for installation and use provided by the manufacturer of the Child Restraint System.

⚠ WARNING

- Always follow the Child Restraint System manufacturer's instructions for installation and use.
- Always properly restrain your child in the Child Restraint System.
- Do not use an infant carrier or a child safety seat that "hooks" over a seat-back, it may not provide adequate protection in an accident.
- After an accident, have the system checked by a professional workshop. Kia recommends to visit an authorised Kia dealer/service partner.

Selecting a Child Restraint System (CRS)

When selecting a Child Restraint System for your child, always:

- Make sure the Child Restraint System has a label certifying that it meets applicable Safety Standards of your country.

A Child Restraint System may only be installed if it was approved in accordance with the requirements of ECE-R44, ECE-R129 or relevant regulation.

- Select a Child Restraint System based on your child's height and weight. The required label or the instructions for use typically provide this information.
- Select a Child Restraint System that fits the vehicle seating position where it will be used.

For the suitability of Child Restraint Systems on the vehicle's seating positions, please refer to "Suitability of each seating position for Belted & ISO-

FIX Child Restraint Systems according to UN regulations (For Europe)" on page 3-36, "Suitability of each seating position for Belted & ISOFIX Child Restraint Systems according to UN regulations (Except Europe)" on page 3-37, "Suitability of each seating position for belted & ISOFIX Child Restraint Systems (CRS) according to UN regulations (For Australia)" on page 3-38

- Read and comply with the warnings and instructions for installation and use provided with the Child Restraint System.

Child Restraint System types

There are three main types of Child Restraint Systems: rearward-facing, forward-facing and booster Child Restraint Systems.

They are classified according to the child's age, height and weight.

Rearward-facing Child Restraint System



A rearward-facing Child Restraint System provides restraint with the seating surface against the back of the child. The harness system holds the child in place, and in an accident, acts to keep the child positioned in the Child

Restraint Systems and reduce the stress to the fragile neck and spinal cord.

All children under the age of one year must always ride in a rearward-facing Child Restraint System. There are different types of rearward-facing Child Restraint Systems: infant-only Child Restraint Systems can only be used rearward-facing. Convertible and 3-in-1 Child Restraint Systems typically have higher height and weight limits for the rearward-facing position, allowing you to keep your child rearward-facing for a longer period of time.

Keep using Child Restraint Systems in the rearward-facing position as long as children fit within the height and weight limits allowed by the Child Restraint System's manufacturer.

Forward-facing Child Restraint System



A forward-facing Child Restraint System provides restraint for the child's body with a harness. Keep children in a forward-facing Child Restraint System with a harness until they reach the top height or weight limit allowed by your Child Restraint System's manufacturer.

Once your child outgrows the forward-facing Child Restraint System, your child is ready for a booster seat.

Booster seats

A booster seat is a Child Restraint System designed to improve the fit of the vehicle's seat belt system. A booster seat positions the seat belt so that it fits properly over the stronger parts of your child's body. Keep your children in booster seats until they are big enough to fit in a seat belt properly.

For a seat belt to fit properly, the lap belt must lie comfortable across the upper thighs, not the stomach. The shoulder belt should lie comfortable across the shoulder and chest and not across the neck or face. Children under age 13 must always be properly restrained to minimise the risk of injury in an accident, sudden stop or sudden manoeuvre.

Installing a Child Restraint System (CRS)

⚠ WARNING

Before installing your Child Restraint System always:

Read and follow the instructions provided by the manufacturer of the Child Restraint System.

Failure to follow all warnings and instructions could increase the risk of the SERIOUS INJURY or DEATH if an accident occurs.

⚠ WARNING

If the vehicle headrest prevents proper installation of a Child Restraint System, the headrest of the respective seating position shall be readjusted or entirely removed.

After selecting a proper Child Restraint System for your child and checking that the Child Restraint System fits properly on the seating position, there are three general steps for a proper installation:

- **Properly secure the Child Restraint System to the vehicle.** All Child Restraint Systems must be secured to the vehicle with the lap belt or lap part of a lap/shoulder belt or with the ISO-FIX toptether and/or ISO-FIX anchorage and/or with the support leg.
- **Make sure the Child Restraint System is firmly secured.** After installing a Child Restraint System to the vehicle, push and pull the seat forward and from side-to-side to verify that it is securely attached to the seat. A Child Restraint System secured with a seat belt should be installed as firmly as possible. However, some side-to-side movement can be expected. When installing a Child Restraint System, adjust the vehicle seat and seat-back (up and down, forward and rearward) so that your child fits in the Child Restraint System in a comfortable manner.
- **Secure the child in the Child Restraint System.** Make sure the child is properly strapped in the Child Restraint System according to the Child Restraint System manufacturer's instructions.

CAUTION

A Child Restraint System in a closed vehicle can become very hot. To prevent burns, check the seating surface and buckles before placing your child in the Child Restraint System.

ISO-FIX anchorage and top-tether anchorage (ISO-FIX anchorage system) for children

The ISO-FIX system holds a Child Restraint System during driving and in an accident. This system is designed to make installation of the Child Restraint System easier and reduce the possibility of improperly installing your Child Restraint System. The ISO-FIX system uses anchors in the vehicle and attachments on the Child Restraint System. The ISO-FIX system eliminates the need to use seat belts to secure the Child Restraint System to the rear seats.

ISO-FIX anchorages are metal bars built into the vehicle. There are two lower anchors for each ISO-FIX seating position that will accommodate a Child Restraint System with lower attachments.

To use the ISO-FIX system in your vehicle, you must have a Child Restraint System with ISO-FIX attachments.

The Child Restraint System manufacturer will provide you with instructions on how to use the Child Restraint System with its attachments for the ISO-FIX anchorages.

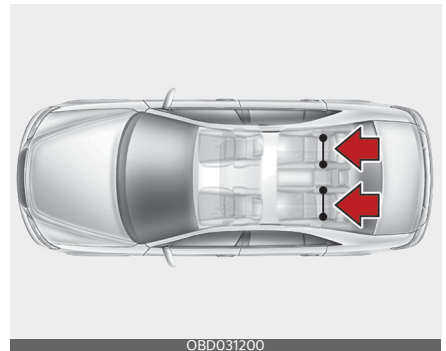

ISO-FIX anchorages have been provided in the left and right outboard rear seat-

ing positions. Their locations are shown in the illustration.

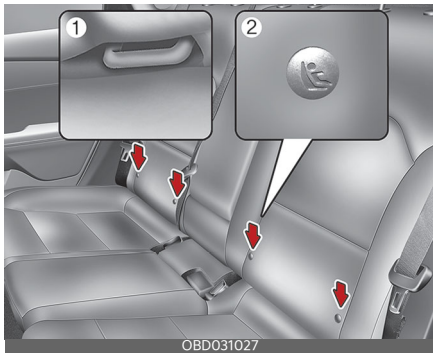

⚠ WARNING

Do not attempt to install a Child Restraint System using ISOFIX anchorages in the rear centre seating position. There are no ISOFIX anchorages provided for this seat. Using the outboard seat anchorages, for the CRS installation on the rear centre seating position, can damage the anchorages.



ISOFIX anchorages are located between the seatback and the seat cushion of the rear seat left and right outboard seating positions, indicated by the symbols.

To use the ISOFIX anchorages, push the upper portion of the ISOFIX anchorage cover.

- * (1): ISOFIX Anchor (2): ISOFIX Anchor Position Indicator (Type A- , Type B- )

Securing a Child Restraint System with the “ISOFIX Anchorage System”

To install an i-Size or ISOFIX-compatible Child Restraint System in either of the rear outboard seating positions:

1. Move the seat belt buckle away from the ISOFIX anchorages.
2. Move any other objects away from the anchorages that could prevent a secure connection between the Child Restraint System and the ISOFIX anchorages.
3. Place the Child Restraint System on the vehicle seat, then attach the seat to the ISOFIX anchorages according to the instructions provided by the Child Restraint System manufacturer.
4. Follow the instructions of the Child Restraint System's manufacturer for proper installation and connection of the ISOFIX attachments on the Child Restraint System to the ISOFIX anchorages.

⚠ WARNING

Take the following precautions when using the ISOFIX system:

- Read and follow all installation instructions provided with your Child Restraint System.
- To prevent the child from reaching and taking hold of unretracted seat belts, buckle all unused rear seat belts and retract the seat belt webbing behind the child. Children can be strangled if a shoulder belt becomes wrapped around their neck and the seat belt tightens.
- NEVER attach more than one Child Restraint System to a single anchorage. This could cause the anchor or attachment to come loose or break.
- Always have the ISOFIX system inspected by your dealer after an accident. An accident can damage the ISOFIX system and may not properly secure the Child Restraint System.

Securing a Child Restraint System seat with "Top-tether Anchorage" system (if equipped)

4door - Type A

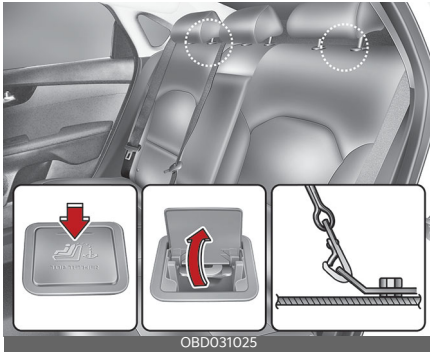

4door - Type B

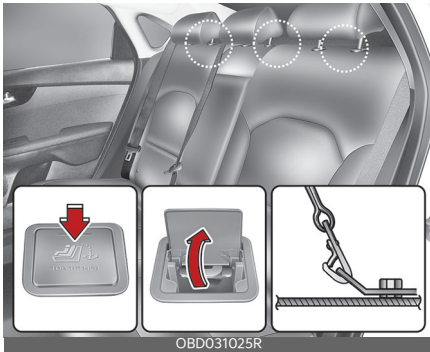

5door - Type A

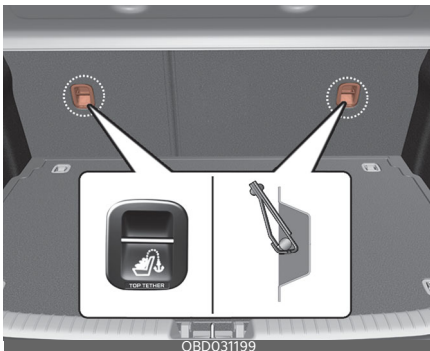

5door - Type B

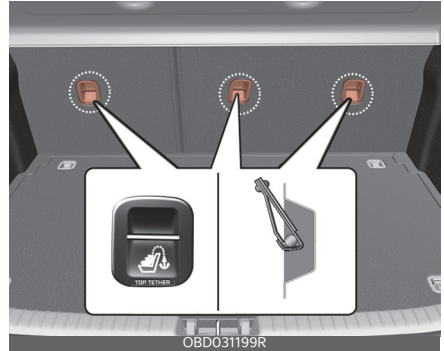

Top-tether anchorages for Child Restraint Systems are located on the shelf behind the rear seats (4Door) and on the back of the rear seatbacks (5 Door).



1. Route the Child Restraint System top-tether strap over the seatback. Placing the top tether strap, please follow the instructions of the Child Restraint System manufacturer.



OCK030028

2. Connect the top-tether strap to the top-tether anchorage, then tighten the top-tether strap according to the instructions of your Child Restraint System's manufacturer to firmly attach the Child Restraint System to the seat.

⚠ WARNING

Take the following precautions when installing the top-tether:

- Read and follow all installation instructions provided with your Child Restraint System.
- NEVER attach more than one Child Restraint System to a single ISOFIX top-tether anchorage. This could cause the anchorage or attachment to come loose or break.
- Do not attach the top-tether to anything other than the correct top-tether anchorage. It may not work properly if attached to something else.
- Child Restraint System anchorages are designed to withstand only those loads imposed by correctly fitted Child Restraint System. Under no circumstances are they to be used for adult seat belts or har-

nesses or for attaching other items or equipment to the vehicle.

⚠ WARNING

Australian design rule

Child restraint anchorages are designed to withstand only those loads imposed by correctly fitted child restraints. Under no circumstances are they to be used for adult seat belts, harnesses, or for attaching other items or equipment to the vehicle.

Securing a Child Restraint System with a lap/shoulder belt

When not using the ISOFIX system, all Child Restraint Systems must be secured to a rear seat with the lap part of a lap/shoulder belt.

Installing a Child Restraint System with a lap/shoulder belt

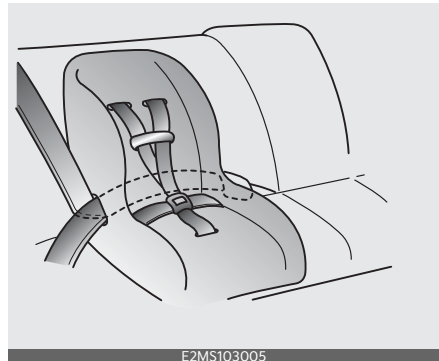

E2MS103005

To install a Child Restraint System on the rear seats, do the following:

1. Place the Child Restraint System on a rear seat and route the lap/shoulder belt around or through the Child Restraint System, following the Child Restraint System manufacturer's instructions.

Make sure the seat belt webbing is not twisted.

2. Fasten the lap/shoulder belt latch into the buckle. Listen for the distinct "click" sound. Position the release button so that it is easy to access in case of an emergency.



3. Remove as much slack from the belt as possible by pushing down on the Child Restraint System whilst feeding the shoulder belt back into the retractor.
4. Push and pull on the Child Restraint System to confirm that the seat belt is holding it firmly in place.



If your Child Restraint System manufacturer recommends the use of atop-tether with the lap/shoulder belt, "ISOFIX anchorage and top-tether anchorage

(ISOFIX anchorage system) for children" on page 3-31.

To remove the Child Restraint System, press the release button on the buckle and then pull the lap/shoulder belt out of the Child Restraint System and allow the seat belt to retract fully.

Suitability of each seating position for Belted & ISOFIX Child Restraint Systems according to UN regulations (For Europe)

- Yes : Suitable for fitment of the designated category of CRS
- No : Not suitable for fitment of the designated category of CRS
- “-” : Not applicable

CRS categories		Seating positions						
		1	2	3		4	5	6
				Airbag ON	Airbag Off			
Universal belted CRS	All mass groups	-	-	No	Yes(F, R)	Yes ¹ (F, R)	Yes ² (F, R)	Yes ¹ (F, R)
i-size CRS	ISOFIX CRF:F2, F2X, R1, R2	-	-	No	No	No	No	No
Carry-cot (ISOFIX lateral facing CRS)	ISOFIX CRF:L1, L2	-	-	No	No	No	No	No
ISOFIX infant* CRS (*: ISOFIX baby CRS)	ISOFIX CRF:R1	-	-	No	No	Yes(R)	No	Yes(R)
ISOFIX toddler CRS - small	ISOFIX CRF:F2,F2X, R2,R2X	-	-	No	No	Yes(F, R)	No	Yes(F, R)
ISOFIX toddler CRS - large* (*: not booster seats)	ISOFIX CRF:F3,R3	-	-	No	No	Yes ³ (F, R)	No	Yes ³ (F, R)
Booster Seat - reduced Width	ISO CRF: B2	-	-	No	No	Yes	No	Yes
Booster Seat - full Width	ISO CRF: B3	-	-	No	No	Yes	No	Yes

F : Forward facing, R : Rearward facing

1): To install Universal CRS to 2nd row outer seating positions, 1st row seat should be adjust forward properly.

2): Never install CRS with a support leg on 2nd row centre seating position.

3): For installation of ISOFIX Large rearward facing toddler CRS, please note below
 - Driver’s seat : the driver’s seat should be moved to mid position and then the seat height should be adjusted to the highest position.

- Front passenger seat: the forward passenger’s seat should be moved forward properly

Suitability of each seating position for Belted & ISOFIX Child Restraint Systems according to UN regulations (Except Europe)

- Yes : Suitable for fitment of the designated category of CRS
- No : Not suitable for fitment of the designated category of CRS
- “-” : Not applicable

CRS categories		Seating positions						
		1	2	3		4	5	6
				Airbag ON	Airbag Off			
Universal belted CRS	All mass groups	-	-	No	Yes (F)	Yes ¹⁾ (F, R)	No	Yes ¹⁾ (F, R)
i-size CRS	ISOFIX CRF:F2, F2X, R1, R2	-	-	No	No	No	No	No
Carry-cot (ISOFIX lateral facing CRS)	ISOFIX CRF:L1, L2	-	-	No	No	No	No	No
ISOFIX infant* CRS (*: ISOFIX baby CRS)	ISOFIX CRF:R1	-	-	No	No	Yes (R)	No	Yes (R)
ISOFIX toddler CRS - small	ISOFIX CRF:F2, F2X, R2, R2X	-	-	No	No	Yes (F, R)	No	Yes (F, R)
ISOFIX toddler CRS - large* (*: not booster seats)	ISOFIX CRF:F3, R3	-	-	No	No	Yes ²⁾ (F, R)	No	Yes ²⁾ (F, R)
Booster Seat - reduced Width	ISO CRF: B2	-	-	No	No	Yes	No	Yes
Booster Seat - full Width	ISO CRF: B3	-	-	No	No	Yes	No	Yes

F : Forward facing, R : Rearward facing

1): To install Universal CRS to 2nd row outer seating positions, 1st row seat should be adjust forward properly.

2): For installation of ISOFIX Large rearward facing toddler CRS, please note below
 - Driver’s seat: the driver’s seat should be moved to mid position and then the seat height should be adjusted to the highest position.

- Front passenger seat: the forward passenger’s seat should be moved forward properly

Suitability of each seating position for belted & ISOFIX Child Restraint Systems (CRS) according to UN regulations (For Australia)

- Yes : Suitable for fitment of the designated category of CRS
- No : Not suitable for fitment of the designated category of CRS
- “-” : Not applicable

CRS categories		Seating positions						
		1	2	3		4	5	6
				Airbag ON	Airbag Off			
Universal belted CRS	All mass groups	-	-	No	Yes (F)	Yes ¹⁾ (F, R)	Yes ²⁾ (F, R)	Yes ¹⁾ (F, R)
i-size CRS	ISOFIX CRF:F2, F2X, R1, R2	-	-	No	No	Yes (F, R)	No	Yes (F, R)
Carry-cot (ISOFIX lateral facing CRS)	ISOFIX CRF:L1, L2	-	-	No	No	No	No	No
ISOFIX infant* CRS (*: ISOFIX baby CRS)	ISOFIX CRF:R1	-	-	No	No	Yes (R)	No	Yes (R)
ISOFIX toddler CRS - small	ISOFIX CRF:F2, F2X, R2, R2X	-	-	No	No	Yes (F, R)	No	Yes (F, R)
ISOFIX toddler CRS - large* (*: not booster seats)	ISOFIX CRF:F3, R3	-	-	No	No	Yes ³⁾ (F, R)	No	Yes ³⁾ (F, R)
Booster Seat - reduced Width	ISO CRF: B2	-	-	No	No	Yes	No	Yes
Booster Seat - full Width	ISO CRF: B3	-	-	No	No	Yes	No	Yes

F : Forward facing, R : Rearward facing

1): To install Universal CRS to 2nd row outer seating positions, 1st row seat should be adjust forward properly.

2): Never install CRS with a support leg on 2nd row centre seating position.

3): For installation of ISOFIX Large rearward facing toddler CRS, please note below
 - Driver’s seat : the driver’s seat should be moved to mid position and then the seat height should be adjusted to the highest position.

- Front passenger seat: the forward passenger’s seat should be moved forward properly

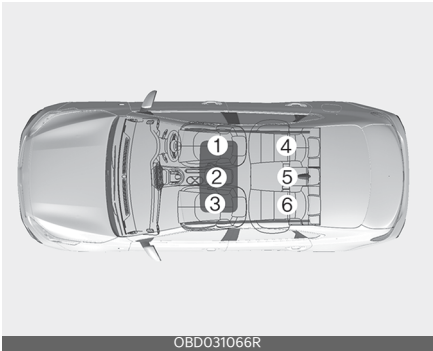
Seat Number	Position in the vehicle	Seating positions
1	Front right	
2	Front centre	
3	Front left	
4	2nd row right	
5	2nd row centre	
6	2nd row left	

* If the vehicle headrest prevents proper installation of a CRS, the headrest of the seating position shall be readjusted or entirely removed

* Never place a rearward facing Child Restraint System on the front passenger seat, unless the air bag is deactivated.

Recommended child restraint systems - For Europe

Mass Group	Size Class	Fixture	Name	Manufacturer	Type of Fixation	ECE-R44Approval No.
Group 0-1 (0 ~ 13kg)	E	ISO/R1	Baby Safe Plus	Britax Römer	Reward facing with ISOFIX base	E1 04301146
Group 1 (9 ~ 18kg)	B1	ISO/F2X	Duo Plus	Britax Römer	Forward facing with vehicle ISOFIX lower anchorage + Top tether	E1 04301133

CRS Manufacturer information

Britax Römer <http://www.britax.com>

Air bag - supplemental restraint system

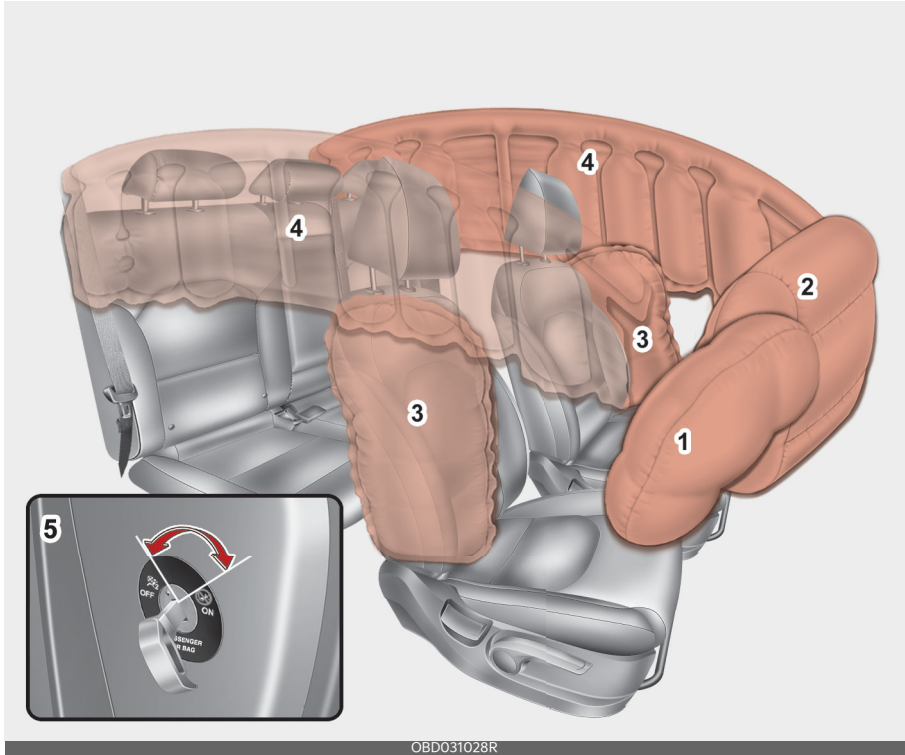

* The actual air bags in the vehicle may differ from the illustration.

1. Driver's front air bag*
2. Passenger's front air bag*
3. Side air bag*
4. Curtain air bag*
5. Passenger's front air bag ON/OFF switch*

* : if equipped

⚠ WARNING

- Even in vehicles with air bags, you and your passengers must always wear the safety belts provided in order to minimise the risk and severity of injury in the event of a collision or rollover.
- SRS and pre-tensioners contain explosive chemicals.

If scrapping a vehicle without removing SRS and pre-tensioners from a vehicle, it may cause fire. Before scrapping a vehicle, contact a professional workshop. Kia recommends to visit an authorised Kia dealer/service partner.

- Keep the SRS parts and wirings away from water or any liquid. If the SRS components are inoperative due to exposure to water or liquids, it may cause fire or severe injury.

How does the air bag system operate

- Air bags are activated (able to inflate if necessary) only when the ignition switch or the ENGINE START/STOP button is turned to the ON position.
- Air bags inflate instantly in the event of a serious frontal collision or side collision (if equipped with a side air bag or curtain air bag) in order to help protect the occupants from serious physical injury.

*** NOTICE****If equipped with rollover sensor**

Also, the air bags inflate instantly in the event of a rollover (if equipped with a side air bag or curtain air bag) in order to help protect the occupants from serious physical injury.

- There is no single speed at which the air bags will inflate.

Generally, air bags are designed to inflate based upon the severity of a collision and its direction. These two factors determine whether the sensors produce an electronic deployment/ inflation signal.

- Air bag deployment depends on a number of factors including vehicle speed, angles of impact and the density and stiffness of the vehicles or objects which your vehicle hits in the collision. The determining factors are not limited to those mentioned above.

- The front air bags will completely inflate and deflate in an instant.

It is virtually impossible for you to see the air bags inflate during an accident.

It is much more likely that you will simply see the deflated air bags hanging out of their storage compartments after the collision.

- In order to help provide protection in a severe collision, the air bags must inflate rapidly. The speed of the air bag inflation is a consequence of extremely short time in which a collision occurs and the need to inflate the air bag between the occupant and the vehicle structures before the occupant impacts those structures.

This speed of inflation reduces the risk of serious or life-threatening injuries in a severe collision and is thus a necessary part of the air bag design.

However, air bag inflation can also cause injuries which can include facial abrasions, bruises and broken bones because the inflation speed also causes the air bags to expand with a great deal of force.

- **There are even circumstances under which contact with the steering wheel air bag can cause fatal injuries, especially if the occupant is positioned excessively close to the steering wheel.**

⚠ WARNING

- To avoid severe personal injury or death caused by deploying air bags in a collision, the driver should sit as far back from the steering wheel air bag as possible (at least 250 mm (10 inches) away). The front passengers should always move their seats as far back as possible and sit back in their seat.
- Air bags inflate instantly in the event of a collision, and passengers may be injured by the air bag expansion force if they are not in a proper position.
- Air bag inflation may cause injuries including facial or bodily abrasions, injuries from broken glasses or burns.

Noise and smoke

When the air bags inflate, they make a loud noise and they leave smoke and powder in the air inside of the vehicle. This is normal and is a result of the ignition of the air bag inflator. After the air bag inflates, you may feel substantial discomfort in breathing due to the contact of your chest with both the seat belt and the air bag, as well as from breathing the smoke and powder. **Open your doors and/or windows as soon as possible after the impact in order to reduce discomfort and prevent prolonged exposure to smoke and powder.**

Though the smoke and powder are non-toxic, they may cause irritation to the skin (eyes, nose and throat, etc). If this is

the case, wash and rinse with cold water immediately and consult a doctor if the symptom persists.

⚠ WARNING

- When the air bags deploy, the air bag related parts in the steering wheel, instrument panel, front seats and/or in both sides of the roof rails above the front and rear doors are very hot. To prevent injury, do not touch the air bag storage area's internal components immediately after an air bag has inflated.
- Do not install or place any accessories near air bag deployment areas, such as the instrument panel, windows, pillars, and roof rails.

Front passenger's air bag warning label for child restraint system

Type A



Type B

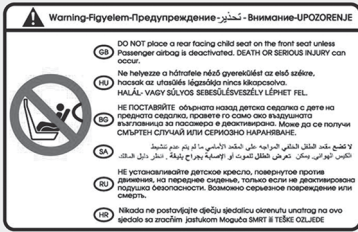

OHM036053L

WARNING

Never place a rear facing child restraint in the front passenger seat, unless the passenger-side air bag is deactivated. An inflating passenger-side air bag could impact the rear-facing child restraint and kill the child.

In addition, we recommend that you do not place front-facing child restraints in the front passenger’s seat either. If the front passenger air bag inflates, it could cause serious or fatal injuries to the child.

If your vehicle is equipped with the passenger’s front air bag ON/OFF switch, you can activate or deactivate the front passenger’s air bag when necessary.

WARNING

- Extreme Hazard! Do not use a rearward facing child restraint on a seat protected by an airbag in front of it!
- NEVER use a rearward facing child restraint on a seat protected by an ACTIVE AIR BAG in front of it. DEATH or SERIOUS INJURY to the CHILD can occur.
- When children are seated in the rear outboard seats of a vehicle equipped

with side and/or curtain air bags, be sure to install the child restraint system as far away from the door side as possible, and securely lock the child restraint system in position. Inflation of side and/or curtain air bags could cause serious injury or death to an infant or child.

Air bag warning light



The purpose of the air bag warning light in your instrument panel is to alert you of a potential problem with your air bag - Supplemental Restraint System (SRS). When the ignition switch or the ENGINE START/STOP button is turned ON, the warning light should illuminate for approximately 3 to 6 seconds, then go off.

Have the system checked if:

- The light does not turn on briefly when you turn the ignition switch or the ENGINE START/STOP button to ON position.
- The light stays on after illuminating for approximately 6 seconds.
- The light comes on whilst the vehicle is in motion.
- The light blinks when the ignition switch or the ENGINE START/STOP button is in ON position.

Passenger's front air bag ON indicator (if equipped)



The passenger's front air bag ON indicator generally illuminates for approximately 4 seconds after the ignition switch or the ENGINE START/STOP button is turned to the ON position. But, if the ignition switch or the ENGINE START/STOP button is turned to the ON position within 3 minutes after ignition OFF, the indicator does not illuminate.

The passenger's front air bag ON indicator also comes on when the passenger's front air bag ON/OFF switch is set to the ON position and goes off when the passenger's front air bag ON/OFF switch is set to the OFF position.

Passenger's front air bag OFF indicator (if equipped)



The passenger's front air bag OFF indicator generally illuminates for approximately 4 seconds after the ignition switch or the ENGINE START/STOP button is turned to the ON position. But, if the ignition switch or the ENGINE START/STOP button is turned to the ON position within 3 minutes after ignition OFF, the indicator does not illuminate.

The passenger's front air bag OFF indicator also comes on when the passenger's front air bag ON/OFF switch is set to the OFF position and goes off when the passenger's front air bag ON/OFF switch is set to the ON position.

CAUTION

If the passenger's front air bag ON/OFF switch malfunctions, the passenger's front air bag OFF indicator will not illuminate (The passenger's front air bag ON indicator comes on) and the passenger's front air bag will inflate in a frontal impact even if the passenger's front air bag ON/OFF switch is set to the OFF position.

In this case, have the passenger's front air bag ON/OFF switch and the SRS air

bag system inspected by a professional workshop.

Kia recommends to visit an authorised Kia dealer/service partner.

SRS components and functions

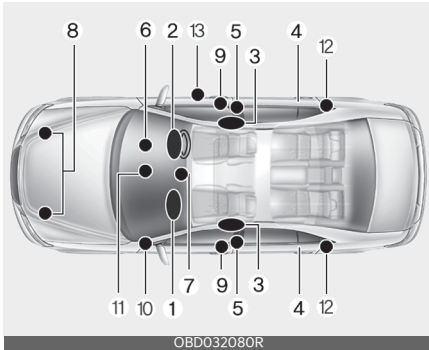

The SRS consists of the following components:

1. Passenger's front air bag module*
2. Driver's front air bag module*
3. Side air bag modules*
4. Curtain air bag modules*
5. Retractor pre-tensioner assemblies*
6. Air bag warning light*
7. SRS control module (SRSCM)* / Roll-over sensor
8. Front impact sensors*
9. Side impact sensors (acceleration)*
10. Passenger's front air bag ON/OFF switch*
11. Passenger's front air bag ON/OFF lamp*
12. Rear retractor pre-tensioner assemblies*
13. Side impact sensors (pressure)*

* : if equipped

The SRSCM continually monitors all SRS components whilst the ignition switch or the ENGINE START/STOP button is ON

to determine if a crash impact is severe enough to require air bag deployment or pre-tensioner seat belt deployment.

The SRS air bag warning light on the instrument panel will illuminate for approximately 3 to 6 seconds after the ignition switch or the ENGINE START/STOP button is turned to the ON position, after which the SRS air bag warning light should go out.

⚠ WARNING

If any of the following conditions occurs, this indicates a malfunction of the SRS. In this case, have the system inspected by a professional workshop. Kia recommends to visit an authorised Kia dealer/service partner.

- The light does not turn on briefly when you turn the ignition switch or the ENGINE START/STOP button to ON position.
- The light stays on after illuminating for approximately 6 seconds.
- The light comes on whilst the vehicle is in motion.
- The light blinks when the ignition switch or the ENGINE START/STOP button is in ON position.

The front air bag modules are located in the centre of the steering wheel, in the front passenger's panel above the glove box. When the SRSCM detects a sufficiently severe impact to the front of the vehicle, it will automatically deploy the front air bags.

Driver's front air bag (1)



Upon deployment, tear seams molded directly into the pad covers will separate under pressure from the expansion of the air bags. Further opening of the covers then allows full inflation of the air bags.

Driver's front air bag (2)

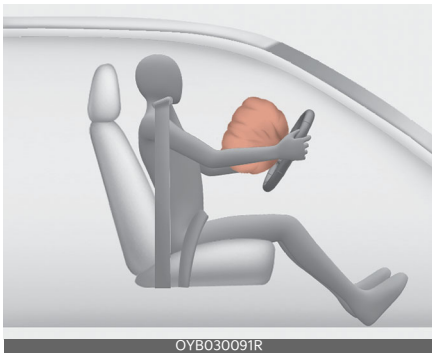

A fully inflated air bag, in combination with a properly worn seat belt, slows the driver's or the passenger's forward motion, reducing the risk of head and chest injury.

Driver's front air bag (3)



After complete inflation, the air bag immediately starts deflating, enabling the driver to maintain forward visibility and the ability to steer or operate other controls.

Passenger's front air bag



⚠ WARNING

- Do not install or place any accessories (drink holder, CD holder, sticker, etc.) on the front passenger's panel above the glove box in a vehicle with a passenger's air bag. Such objects may become dangerous projectiles and cause injury if the passenger's air bag inflates.
- When installing a container of liquid air freshener inside the vehicle, do not

place it near the instrument cluster nor on the instrument panel surface. It may become a dangerous projectile and cause injury if the passenger's air bag inflates.

WARNING

- If an air bag deploys, there may be a loud noise followed by a fine dust released in the vehicle. These conditions are normal and are not hazardous - the air bags are packed in this fine powder. The dust generated during air bag deployment may cause skin or eye irritation as well as aggravate asthma for some persons. Always wash all exposed skin areas thoroughly with cold water and mild soap after an accident in which the air bags were deployed.
- The SRS can function only when the ignition switch or the ENGINE START/STOP button is in the ON position. If the SRS air bag warning light does not illuminate, or continuously remains on after illuminating for about 6 seconds when the ignition switch or the ENGINE START/STOP button is turned to the ON position, or after the engine is started, comes on whilst driving, the SRS is not working properly. In this case, have the system inspected by a professional workshop. Kia recommends to visit an authorised Kia dealer/service partner.
- Before you replace a fuse or disconnect a battery terminal, turn the ignition switch or the ENGINE START/STOP button to the OFF position. Never remove or replace the air bag related fuse(s) when the ENGINE START/STOP button is in the ON position. Failure to heed this warning will

cause the SRS air bag warning light to illuminate.

Driver's and passenger's front air bag



Your vehicle is equipped with a Supplemental Restraint (Air Bag) System and the lap/shoulder belts at both the driver and passenger seating positions.

The indications of the system's presence are the letters "AIRBAG" embossed on the air bag pad cover in the steering wheel and the passenger's side front panel pad above the glove box.

The SRS consists of air bags installed under the pad covers in the centre of the steering wheel and in the passenger's side front panel above the glove box.

Passenger's front air bag

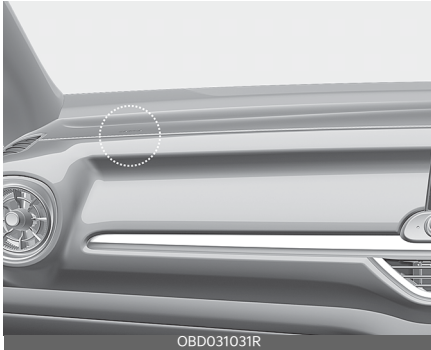

The purpose of the SRS is to provide the vehicle's driver and/or the front passenger with additional protection than that offered by the seat belt system alone in case of a frontal impact of sufficient severity. The SRS uses sensors to gather information about the driver's seat position, the driver's and front passenger's seat belt usage and impact severity.

The seat belt buckle sensors (if equipped) determine if the driver and front passenger's seat belts are fastened. These sensors provide the ability to control the SRS deployment based on whether or not the seat belts are fastened, and how severe the impact is.

⚠ WARNING

Always use seat belts and child restraints - every trip, every time, every-one! Air bags inflate with considerable force and in the blink of an eye. Seat belts help keep occupants in proper position to obtain maximum benefit from the air bag. Even with air bags, improperly and unbelted occupants can be severely injured when the air bag inflates. Always follow the precautions about seat belts, air bags and occupant safety contained in this manual.

To reduce the chance of serious or fatal injuries and receive the maximum safety benefit from your restraint system:

- Never place a child in any child or booster seat in the front seat.
- ABC - Always Buckle Children in the 2nd row seat. It is the safest place for children of any age to ride.
- Front and side air bags can injure occupants improperly positioned in the front seats.
- Move your seat as far back as practical from the front air bags, whilst still maintaining control of the vehicle.
- You and your passengers should never sit or lean unnecessarily close to the air bags. Improperly positioned drivers and passengers can be severely injured by inflating air bags.
- Never lean against the door or centre console - always sit in an upright position.
- Do not allow a passenger to ride in the front seat when the passenger's front air bag OFF indicator is illuminated, because the air bag will not deploy in the event of a moderate or severe frontal crash.
- No objects should be placed over or near the air bag modules on the steering wheel, instrument panel or the front passenger's panel above the glove box, because any such object could cause harm if the vehicle is in a crash severe enough to cause the air bags to deploy.
- Do not tamper with or disconnect SRS wiring or other components of the SRS system. Doing so could result in injury, due to accidental deployment of the air bags or by rendering the SRS inoperative.

- If the SRS air bag warning light remains illuminated whilst the vehicle is being driven, have the system inspected by a professional workshop. Kia recommends to visit an authorised Kia dealer/service partner.
- Air bags can only be used once - have the system replaced by a professional workshop. Kia recommends to visit an authorised Kia dealer/service partner.
- The SRS is designed to deploy the front air bags only when an impact is sufficiently severe and when the impact angle is less than 30° from the forward longitudinal axis of the vehicle. Additionally, the air bags will only deploy once. Seat belts must be worn at all times.
- Front air bags are not intended to deploy in side-impact, rear-impact or rollover crashes. In addition, front air bags will not deploy in frontal crashes below the deployment threshold.
- A child restraint system must never be placed in the front seat. The infant or child could be severely injured or killed by an air bag deployment in case of an accident.
- Children age 13 and under must always be properly restrained in the rear seat. Never allow children to ride in the front passenger seat. If a child over 13 must be seated in the front seat, he or she must be properly belted and the seat should be moved as far back as possible.
- For maximum safety protection in all types of crashes, all occupants including the driver should always wear their seat belts whether or not an air bag is also provided at their seating

position to minimise the risk of severe injury or death in the event of a crash. Do not sit or lean unnecessarily close to the air bag whilst the vehicle is in motion.

- Sitting improperly or out of position can result in serious or fatal injury in a crash. All occupants should sit upright with the seat back in an upright position, centred on the seat cushion with their seat belt on, legs comfortably extended and their feet on the floor until the vehicle is parked and the ignition switch or the ENGINE START/STOP button is in the OFF position.
- The SRS air bag system must deploy very rapidly to provide protection in a crash. If an occupant is out of position because of not wearing a seat belt, the air bag may forcefully contact the occupant causing serious or fatal injuries.

Passenger's front air bag ON/OFF switch (if equipped)



The passenger's front air bag can be deactivated by the passenger's front air bag ON/OFF switch if a child restraint is installed on the front passenger's seat or

if the front passenger's seat is unoccupied by a person.

To ensure the safety of your child, the passenger's front air bag must be deactivated when it should be necessary to install a rearward facing child seat on the front passenger seat in exceptional circumstances.

To deactivate or reactivate the passenger's front air bag:

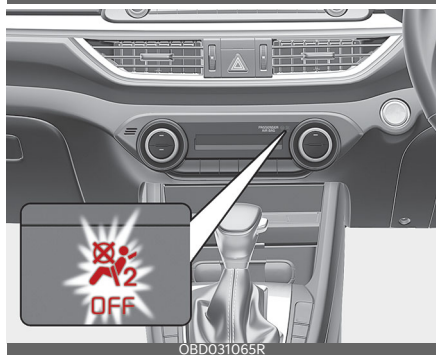

To deactivate the passenger's front air bag, insert the master key into the passenger's front air bag ON/OFF switch and turn it to the OFF position.

The passenger's front air bag OFF indicator will illuminate and stay on until the passenger's front air bag is reactivated.

To reactivate the passenger's front air bag, insert the master key into the pas-

senger's front air bag ON/OFF switch and turn it to the ON position. The passenger's front air bag OFF indicator will go out.

⚠ WARNING

The front air bag ON/OFF switch could turn by using a similar small rigid device. Always check the status of the front air bag ON/OFF switch and passenger's front air bag OFF indicator.

* NOTICE

- When the passenger's front air bag ON/OFF switch is set to the ON position, the passenger's front air bag is activated and child or infant seat should not be installed on the front passenger seat.
- When the passenger's front air bag ON/OFF switch is set to the OFF position, the passenger's front air bag is deactivated.

⚠ CAUTION

- If the passenger's front air bag ON/OFF switch is not working properly, the air bag warning light (🚨) on the instrument panel will illuminate. And, the passenger's front air bag OFF indicator (🚨) will not illuminate (The passenger's front air bag ON indicator comes on), the SRS Control Module reactivates the passenger's front air bag and the passenger's front air bag will inflate in frontal impact crashes even if the passenger's front air bag ON/OFF switch is set to the OFF position.

In this case, have the system inspected by a professional workshop.

Kia recommends to visit an authorised Kia dealer/service partner.

- If the SRS air bag warning light blinks or does not illuminate when the ignition switch or the ENGINE START/STOP button is in the ON position, or if it illuminates whilst the vehicle is being driven, have the system inspected by a professional workshop. Kia recommends to visit an authorised Kia dealer/service partner.

⚠ WARNING

- The driver is responsible for the proper position of the passenger's front air bag ON/OFF switch.
- Deactivate the passenger's front air bag only when the Engine start/stop button is in the OFF position, or the malfunction may occur in the SRS Control Module.

And there may be a danger that the driver's and/or front passenger's and/or side and curtain air bag may fail to trigger, or not trigger correctly during a collision.

- Never install a rearward facing child seat on the front passenger's seat unless the passenger's front air bag has been deactivated. The infant or child could be severely injured or killed by an air bag deployment in case of an accident.
- Even though your vehicle is equipped with the passenger's front air bag ON/OFF switch, do not install a child restraint system in the front passenger's seat. A child restraint system must never be placed in the front seat. Children who are too large for child restraint systems should always occupy the rear seat and use the available lap/shoulder belts. Children

are afforded the most safety in the event of an accident when they are restrained by a proper restraint system in the rear seat.

- As soon as the child seat is no longer needed on the front passenger's seat, reactivate the front passenger's air bag.

⚠ WARNING

No attaching objects

No objects (such as crash pad cover, mobile phone holder, cup holder, perfume or stickers) should be placed over or near the air bag modules on the steering wheel, instrument panel, windscreen glass, and the front passenger's panel above the glove box. Such objects could cause harm if the vehicle is in a crash severe enough to cause the air bags to deploy. Do not place any objects over the air bag or between the air bag and yourself.

Side air bag (if equipped)

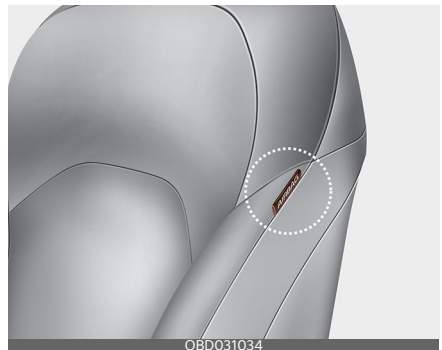

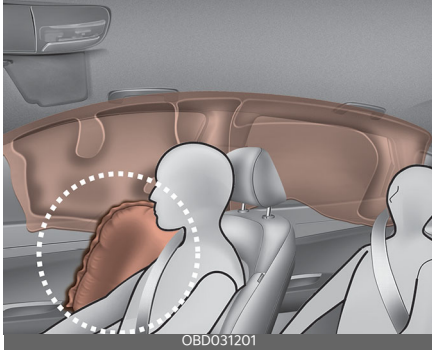

* The actual air bags in the vehicle may differ from the illustration.

Your vehicle is equipped with a side air bag in each front seat.

The purpose of the air bag is to provide the vehicle's driver and/or the front passenger with additional protection than that offered by the seat belt alone.

The side air bags are designed to deploy only during certain side-impact collisions, depending on the crash severity, angle, speed and point of impact. However, when side deployment threshold is satisfied at front-impact, side air bags may deploy. The side air bags are not designed to deploy in all side impact or rollover situations.

The side air bags may deploy on the side of the impact or on both side.

⚠ CAUTION

if equipped with rollover sensor

- Also, both side of the side air bags deploy in certain rollover situations.
- The side air bag may deploy when the rollover sensor detects the situation as a rollover.

⚠ WARNING

Do not allow the passengers to lean their heads or bodies onto doors, put their arms on the doors, stretch their arms out of the window, or place objects between the doors and passengers when they are seated on seats equipped with side and/or curtain air bags.

⚠ WARNING

- The side air bag is supplemental to the driver's and the passenger's seat belt systems and is not a substitute for them. Therefore your seat belts must be worn at all times whilst the vehicle is in motion. The air bags deploy only in certain side impact or rollover* conditions severe enough to cause significant injury to the vehicle occupants.
- For best protection from the side air bag system and to avoid being injured by the deploying side air bag, both front seat occupants should sit in an upright position with the seat belt properly fastened. The driver's hands should be placed on the steering wheel at the 9:00 and 3:00 positions. The passenger's arms and hands should be placed on their laps.
- Do not use any accessory seat covers.
- Use of seat covers could reduce or prevent the effectiveness of the system.
- To prevent unexpected deployment of the side air bag that may result in personal injury, avoid impact to the side impact sensor when the ignition switch or the ENGINE START/STOP button is in the ON position.

- If the seat or seat cover is damaged, have the system serviced by a professional workshop.
Kia recommends to visit an authorised Kia dealer/service partner.
- Never place or insert any object into any small opening near side airbag labels attached to the vehicle seats. When the air bag deploys, the object may affect the deployment and result in unexpected accident or bodily harm.

* Only vehicle equipped with rollover sensor.

⚠ WARNING

No attaching objects

- Do not place any objects over the air bag or between the air bag and yourself. Also, do not attach any objects around the area the air bag inflates such as the door, side door glass, front and rear pillar.
- Do not place any objects between the door and the seat. They may become dangerous projectiles if the side air bag inflates.
- Do not install any accessories on the side or near the side air bags.

Curtain air bag (if equipped)

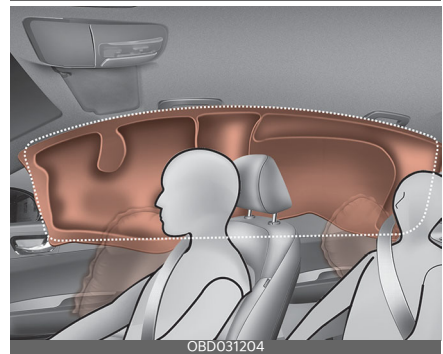
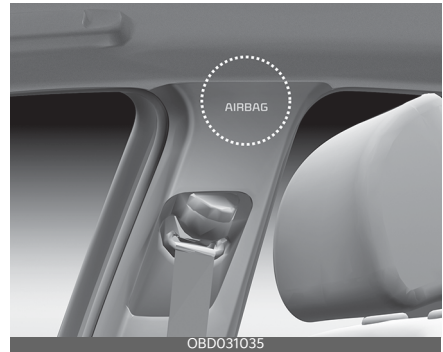

* The actual air bags in the vehicle may differ from the illustration.

Curtain air bags are located along both sides of the roof rails above the front and rear doors.

They are designed to help protect the heads of the front seat occupants and the rear outboard seat occupants in certain side impact collisions.

The curtain air bags are designed to deploy during certain side impact collisions, depending on the crash severity, angle, speed and point of impact. However, when side deployment threshold is satisfied at front impact, side air bags may deploy.

The curtain air bags may deploy on the side of the impact or on both side.

The curtain air bags are not designed to deploy in all side impacts or rollover situations.

* NOTICE

if equipped with rollover sensor

- Also, both sides of the curtain air bags deploy in certain rollover situations.
- The curtain air bag may deploy when the rollover sensor detects the situation as a rollover.

⚠ WARNING

No attaching objects

- Do not place any objects over the air bag. Also, do not attach any objects around the area the air bag inflates such as the door, side door glass, front and rear pillar, roof side rail.
- Do not hang hard or breakable objects on the coat hook.
- Do not hang heavy items on the coat hooks for safety reasons.

⚠ WARNING

- In order for side and curtain air bags to provide the best protection, front seat occupants and outboard rear occupants should sit in an upright position with the seat belts properly fastened. Importantly, children should sit in a proper child restraint system in the rear seat.
- When children are seated in the rear outboard seats, they must be seated in the proper child restraint system. Make sure to position the child restraint system as far away from the door side as possible, and secure the child restraint system in a locked position.

- Do not allow the passengers to lean their heads or bodies against doors, put their arms on the doors, stretch their arms out of the window or place objects between the doors and passengers when they are seated on seats equipped with side and curtain air bags.
- Never try to open or repair any components of the side curtain air bag system. If necessary, have the system serviced by a professional workshop. Kia recommends to visit an authorised Kia dealer/service partner.

Failure to follow the above instructions can result in injury or death to the vehicle occupants in an accident.

Inflation and non-inflation conditions of the airbag

There are many types of accidents in which the air bag would not be expected to provide additional protection. These include rear impacts, second or third collisions in multiple impact accidents, as well as low speed impacts.

Air bag collision sensors



OBDO31037R

1



2



3



4



* The actual shape and position of sensors may differ from the illustration.

1. SRS control module / Rollover sensor (if equipped)
2. Front impact sensor (if equipped)
3. Side pressure sensor (if equipped)
4. Side impact sensor (if equipped)

⚠ WARNING

- Do not hit or allow any objects to impact the locations where air bag or sensors are installed.

This may cause unexpected air bag deployment, which could result in serious personal injury or death.

- If the installation location or angle of the sensors is altered in any way, the air bags may deploy when they should not or they may not deploy when they should, causing severe injury or death.

Therefore, do not try to perform maintenance on or around the air bag sensors. Have the system serviced by a professional workshop.

Kia recommends to visit an authorised Kia dealer/service partner.

- Problems may arise if the sensor installation angles are changed due to the deformation of the front bumper, body or front door and B pillars where side collision sensors are installed. In this case, have the system serviced by a professional workshop.

Kia recommends to visit an authorised Kia dealer/service partner.

- Your vehicle has been designed to absorb impact and deploy the air bag(s) in certain collisions.

Use only Kia Genuine Parts or those of an equivalent standard to install bumper guards or replace a bumper. If not, it may adversely affect your vehicle's collision and air bag deployment performance.

⚠ WARNING

If equipped with rollover sensor

- If your vehicle is equipped with side and curtain air bag, set the ignition

switch or the ENGINE START/STOP button is in the OFF or ACC position when the vehicle is being towed.

- The side and curtain air bag may deploy when the ignition switch or the ENGINE START/STOP button is ON, and the rollover sensor detects the situation as a rollover.

Air bag inflation conditions

Front air bags

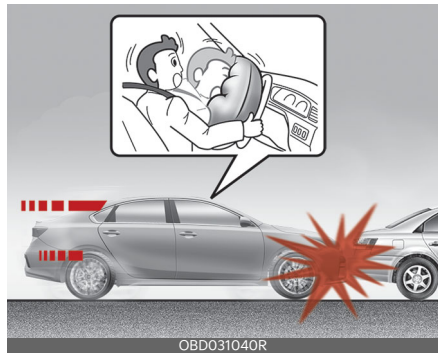

Front air bags are designed to inflate in a frontal collision depending on the intensity, speed or angles of impact of the front collision.

Side and curtain air bags (if equipped)



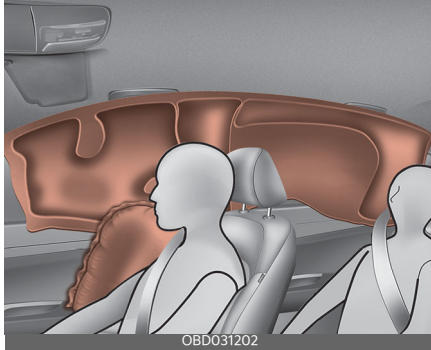

* The actual air bags in the vehicle may differ from the illustration.

Side and curtain air bags are designed to inflate when an impact is detected by side collision sensors depending on the strength, speed or angles of impact resulting from a side impact collision.

Although the front air bags (driver's and front passenger's air bags) are designed to inflate only in frontal collisions, they also may inflate in other types of collisions if the front impact sensors detect a sufficient impact. Side air bags (side and/or curtain air bags) are designed to inflate only in side impact collisions, but they may inflate in other collisions if the side impact sensors detect a sufficient impact.

If the vehicle chassis is impacted by bumps or objects on unpaved roads or sidewalks, air bags may deploy. Drive carefully on unpaved roads or on surfaces not designed for vehicle traffic to prevent unintended air bag deployment.

*** NOTICE**

If equipped with rollover sensor

Also, the side and curtain air bags are designed to inflate when a rollover is detected by a rollover sensor.

Air bag non-inflation conditions

- In certain low-speed collisions the air bags may not deploy. The air bags are designed not to deploy in such cases because they may not provide benefits beyond the protection of the seat belts in such collisions.

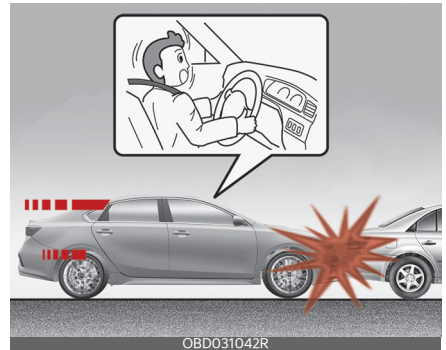

- Air bags are not designed to inflate in rear collisions, because occupants are moved backward by the force of the impact. In this case, inflated air bags would not be able to provide any additional benefit.

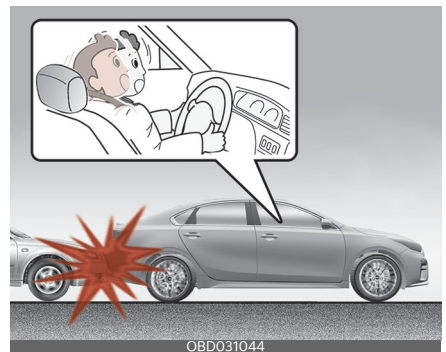

- Front air bags may not inflate in side impact collisions, because occupants move to the direction of the collision, and thus in side impacts, front air bag deployment would not provide additional occupant protection.



- However, if equipped with side and curtain air bags, the air bags may inflate depending on the intensity, vehicle speed and angles of impact.
- In an angled collision, the force of impact may direct the occupants in a direction where the air bags would not be able to provide any additional benefit, and thus the sensors may not deploy any air bags.



- Just before impact, drivers often brake heavily. Such heavy braking lowers the front portion of the vehicle causing it to "ride" under a vehicle with a higher ground clearance. Air bags may not inflate in this "under-ride" situation because deceleration forces that are detected by sensors

may be significantly reduced by such "under-ride" collisions.

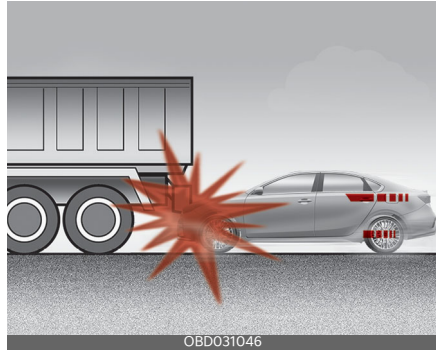

- Front air bags may not inflate in roll-over accidents because front air bag deployment would not provide additional occupant protection.

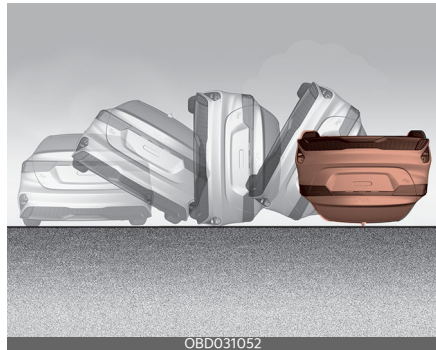

*** NOTICE**

If equipped with rollover sensor

However, if equipped with side and curtain air bags, the air bags may inflate in a rollover, when it is detected by the rollover sensor.

*** NOTICE**

Without rollover sensor

However, side and/or curtain air bags may inflate when the vehicle is rolled over by a side impact collision, if the

vehicle is equipped with side air bags and curtain air bags.

- Air bags may not inflate if the vehicle collides with objects such as utility poles or trees, where the point of impact is concentrated to one area and the full force of the impact is not delivered to the sensors.

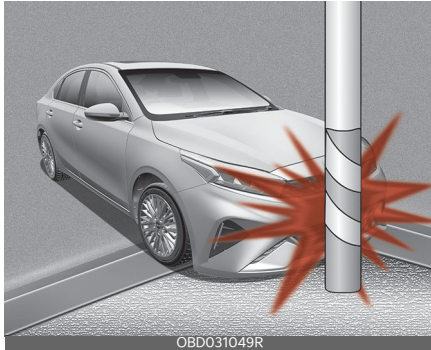

SRS Care

The SRS is virtually maintenance-free and so there are no parts you can safely service by yourself. If the SRS air bag warning light does not illuminate, or continuously remains on, have the system inspected by a professional workshop. Kia recommends to visit an authorised Kia dealer/service partner.

⚠ WARNING

- Modification to SRS components or wiring, including the addition of any kind of badges to the pad covers or modifications to the body structure, can adversely affect SRS performance and lead to possible injury.
- For cleaning the air bag pad covers, use only a soft, dry cloth or one which has been moistened with plain water. Solvents or cleaners could adversely

affect the air bag covers and proper deployment of the system.

- No objects should be placed over or near the air bag modules on the steering wheel, instrument panel, and the front passenger's panel above the glove box, because any such object could cause harm if the vehicle is in a crash severe enough to cause the air bags to inflate.
- If the air bags inflate, have the system replaced by a professional workshop. Kia recommends to visit an authorised Kia dealer/service partner.
- Do not tamper with or disconnect SRS wiring, or other components of the SRS system. Doing so could result in injury, due to accidental inflation of the air bags or by rendering the SRS inoperative.
- If components of the air bag system must be discarded, or if the vehicle must be scrapped, certain safety precautions must be observed. An authorised Kia dealer knows these precautions and can give you the necessary information. Failure to follow these precautions and procedures could increase the risk of personal injury.
- If your car was flooded and has soaked carpeting or water on flooring, you shouldn't try to start the engine; in this case, have your vehicle inspected by a professional workshop. Kia recommends to contact an authorised Kia dealer/service partner.

Additional safety precautions

- **Never let passengers ride in the cargo area or on top of a folded-down back seat.** All occupants should sit upright, fully back in their

seats with their seat belts on and their feet on the floor.

- **Passengers should not move out of or change seats whilst the vehicle is moving.** A passenger who is not wearing a seat belt during a crash or emergency stop can be thrown against the inside of the vehicle, against other occupants, or out of the vehicle.
- **Each seat belt is designed to restrain one occupant.** If more than one person uses the same seat belt, they could be seriously injured or killed in a collision.
- **Do not use any accessories on seat belts.** Devices claiming to improve occupant comfort or reposition the seat belt can reduce the protection provided by the seat belt and increase the chance of serious injury in a crash.
- **Passengers should not place hard or sharp objects between themselves and the air bags.** Carrying hard or sharp objects on your lap or in your mouth can result in injuries if an air bag inflates.
- **Keep occupants away from the air bag covers.** All occupants should sit upright, fully back in their seats with their seat belts on and their feet on the floor. If occupants are too close to the air bag covers, they could be injured if the air bags inflate.
- **Do not attach or place objects on or near the air bag covers.** Any object attached to or placed on the front or side air bag covers could interfere with the proper operation of the air bags.
- **Do not modify the front seats.** Modification of the front seats could interfere with the operation of the

supplemental restraint system sensing components or side air bags.

- **Do not place items under the front seats.** Placing items under the front seats could interfere with the operation of the supplemental restraint system sensing components and wiring harnesses.
- **Never hold an infant or child on your lap.** The infant or child could be seriously injured or killed in the event of a crash. All infants and children should be properly restrained in appropriate child safety seats or seat belts in the rear seat.

WARNING

- Sitting improperly or out of position can cause occupants to be shifted too close to a deploying air bag, strike the interior structure or be thrown from the vehicle resulting in serious injury or death.
- Always sit upright with the seatback in an upright position, centred on the seat cushion with your seat belt on, legs comfortably extended and your feet on the floor.

Adding equipment to or modifying your air bag-equipped vehicle

If you modify your vehicle by changing your vehicle's frame, bumper system, front end or side sheet metal or ride height, this may affect the operation of your vehicle's air bag system.

Air bag warning label (if equipped)



Air bag warning labels are attached to alert the passengers of the potential risk of the air bag system.

Note that these government warnings focus on the risk of children. We also want you to be aware of the risks which adults are exposed to that have been described in previous pages.

Keys	4-6
• Record your key number	4-6
• Battery replacement	4-6
• Remote key	4-7
• Smart key.....	4-9
• Theft-alarm system.....	4-12
• Immobiliser system	4-14
• Door locks.....	4-15
• Rear Occupant Alert (ROA) system	4-19
Safe Exit Warning (SEW)	4-20
• Safe Exit Warning settings.....	4-21
• Safe Exit Warning operation	4-22
• Safe Exit Warning malfunction and limitations	4-23
Trunk(For 4door)	4-25
• Opening the trunk	4-25
• Closing the trunk.....	4-25
• Emergency trunk safety release	4-26
Smart Trunk(For 4door)	4-27
• How to use the Smart Trunk.....	4-27
• How to deactivate the Smart Trunk function using the smart key... 4-28	
• Detecting area	4-29
Tailgate(For 5door)	4-30
• Opening the tailgate	4-30
• Closing the tailgate.....	4-30
• Emergency tailgate safety release.....	4-31
Windows	4-32
• Window opening and closing	4-33
• Power window lock button	4-35
Bonnet	4-37

4 Features of your vehicle

• Opening the bonnet	4-37
• Bonnet open warning.....	4-37
• Closing the bonnet	4-38
Fuel filler door	4-39
• Opening the fuel filler door	4-39
• Closing the fuel filler door	4-40
Sunroof.....	4-41
• Sunshade	4-42
• Tilt open/close	4-42
• Slide open/close	4-43
• Automatic reversal	4-43
• Resetting the sunroof.....	4-44
• Sunroof open warning.....	4-45
Steering wheel	4-45
• Motor Driven Power Steering (MDPS)	4-45
• Tilt & telescopic steering wheel	4-46
• Heated steering wheel.....	4-47
• Horn	4-47
Mirrors	4-48
• Inside rear view mirror.....	4-48
• Outside rear view mirror.....	4-49
Instrument cluster.....	4-52
• Instrument Cluster Control	4-53
• LCD Display Control.....	4-53
• Gauges.....	4-54
• Transmission Shift Indicator	4-59
LCD display	4-62
• LCD display modes (for Type B cluster)	4-62
• Warning messages (for Type B cluster).....	4-69
Trip Computer	4-74
• Trip information (Trip computer) (For Type A cluster)	4-74

• Trip information (trip computer) (For Type B cluster).....	4-76
Warning and indicator lights	4-79
• Warning lights.....	4-79
• Indicator lights.....	4-86
Rear View Monitor (RVM)	4-89
• Detecting Sensor	4-89
• Rear View Monitor settings.....	4-90
• Rear View Monitor operation.....	4-90
• Rear view	4-91
• Extended Rear View Monitor	4-91
• Rear View Monitor malfunction and limitations.....	4-92
Reverse Parking Distance Warning (PDW)	4-93
• Reverse Parking Distance Warning settings.....	4-94
• Reverse Parking Distance Warning operation	4-94
• Reverse Parking Distance Warning malfunction and precautions... 4-95	
Forward/Reverse Parking Distance Warning (PDW)	4-96
• Forward/Reverse Parking Distance Warning settings.....	4-96
• Forward/Reverse Parking Distance Warning operation.....	4-97
• Forward/Reverse Parking Distance Warning malfunction and limitations	4-98
Lighting.....	4-100
• Battery saver function.....	4-100
• Headlamp delay function.....	4-100
• Headlamp welcome function.....	4-101
• Daytime Running Light (DRL).....	4-101
• Lighting control.....	4-101
• Operating high beam	4-104
• Operating turn signals and lane change signals	4-105
• Operating front fog light	4-105
• Operating rear fog light	4-106

4 Features of your vehicle

• High Beam Assist (HBA)	4-107
• Headlight levelling device	4-109
Wipers and washers	4-110
• Operating windscreen washers (front)	4-111
Interior lights	4-113
• Map lamp.....	4-113
• Room lamp	4-114
• Vanity mirror lamp	4-115
• Glove box lamp.....	4-115
Climate control system	4-116
• System operation.....	4-116
• Climate control air filter.....	4-117
• Air conditioning refrigerant label.....	4-118
• Checking the amount of air conditioner refrigerant and compressor lubricant.....	4-118
Manual climate control system	4-120
• Heating and air conditioning	4-121
Automatic climate control system.....	4-126
• Heating and air conditioning automatically.....	4-127
• Heating and air conditioning manually.....	4-128
Windscreen defrosting and defogging.....	4-133
• Defogging inside windscreen with manual climate control system. 4-133	
• Defrosting outside windscreen with manual climate control system 4-133	
• Defogging inside windscreen with automatic climate control.4-134	
• Defrosting outside windscreen with automatic climate control.....4- 134	
• Auto defogging system (only for automatic climate control system)	4-134
• Sunroof inside air recirculation.....	4-135

• Automatic Air Ventilation.....	4-135
• Activate upon Washer Fluid Use	4-136
• Recirculation Mode Plus	4-136
• Defroster	4-137
• Defogging logic.....	4-137
Storage compartment	4-139
• Centre console storage	4-139
• Glove box.....	4-139
Interior features.....	4-140
• Cigarette lighter	4-140
• Ashtray.....	4-140
• Cup holder.....	4-141
• Sliding armrest	4-142
• Seat warmer	4-142
• Air ventilation seat	4-144
• Sun visor.....	4-144
• USB charger	4-145
• Power outlet	4-146
• Wireless smart phone charging system.....	4-146
• Coat hook	4-148
• Luggage net holder.....	4-149
• Cargo area cover	4-150
• Luggage tray	4-150

Features of your vehicle

Keys

Record your key number

The key code number is stamped on the key code tag attached to the key set.

If you lose your keys, Kia recommends to contact an authorised Kia dealer/service partner. Remove the key code tag and store it in a safe place. Also, record the key code number and keep it in a safe place (not in the vehicle).

⚠ WARNING

Never leave the keys in your vehicle

Leaving children unattended in a vehicle with the keys is dangerous even if the vehicle is ACC or ON position.

Unattended children could place the key in the ignition switch or press the ENGINE START/STOP button and may operate power windows or other controls, or even make the vehicle move, which could result in **SERIOUS BODILY INJURY OR EVEN DEATH**. Never leave the keys in your vehicle with unsupervised children, when the engine is running.

Battery replacement

The remote key or smart key uses a 3 volt lithium battery which will normally last for several years.



When replacement is necessary, use the following procedure.

1. Insert a slim tool into the slot and gently pry open the remote key or smart key cover.
2. Replace the battery with a new battery (CR2032). When replacing the battery, make sure the battery position.
3. Install the battery in the reverse order of removal.

For remote key or smart key replacement, Kia recommends to visit an authorised Kia dealer/service partner.

⚠ WARNING

THIS PRODUCT CONTAINS A BUT-TON BATTERY

If swallowed, a lithium button battery can cause severe or fatal injuries within 2 hours. Keep batteries out of reach of children. If you think batteries may have been swallowed or placed inside any part of the body, seek immediate medical attention.

⚠ CAUTION

- The remote key or smart key is designed to give you years of trouble-free use, however it can malfunction if

exposed to moisture or static electricity. If you are unsure how to use or replace the battery, Kia recommends to contact an authorised Kia dealer/ service partner.

- Using the wrong battery can cause the remote key or smart key to malfunction. Be sure to use the correct battery.
- To avoid damaging the remote key or smart key, don't drop it, get it wet, or expose it to heat or sunlight.

CAUTION



An inappropriately disposed battery can be harmful to the environment and human health.

Dispose the battery according to your local law(s) or regulation.

Remote key

With a remote key, you can lock or unlock the door and trunk/tailgate.

Type A



OCD041488L

Type B



ODL3A041655

Lock (1)

All doors are locked if the lock button is pressed whilst all doors are closed. The hazard warning lights will blink once to indicate that all doors are locked.

However, if any door, engine bonnet or trunk/tailgate remains open, the hazard warning lights will not operate. If all doors, engine bonnet and trunk/tailgate are closed after the lock button is pressed, the hazard warning lights will blink once.

Unlock (2)

All doors are unlocked if the unlock button is pressed.

The hazard warning lights will blink twice to indicate that all doors are unlocked.

After pressing this button, the doors will lock automatically unless you open any door within 30 seconds.

If your vehicle is equipped with 2 Press Unlock function (if equipped), when you press the unlock button (2), the driver's door will unlock. The hazard warning lights will blink two times. Then press the unlock button (2) twice within 4 seconds

and all doors and trunk will unlock. The hazard warning lights will blink two times.

You can activate or deactivate the 2 Press Unlock function by selecting 'User settings (LCD display) or Setup → Vehicle (Infotainment System screen) → Door → 2 Press Unlock'. (if equipped)

Trunk/tailgate unlock (3)

The trunk/tailgate is unlocked if the button is pressed for more than 1 second. The hazard warning lights will blink twice to indicate that the trunk/tailgate is unlocked. However, after pressing this button, the trunk/tailgate will lock automatically unless you open the trunk/tailgate within 30 seconds.

Once the trunk/tailgate is opened and then closed, the trunk/tailgate will lock automatically.

Panic alarm (4) (if equipped)

1. Press the panic button (4) for more than 1 second.
2. The horn sounds and hazard warning light flash for about 27 seconds.

* NOTICE

To stop the horn and lights, press any button on the key.

Start-up

* For more information, refer to "Key positions" on page 6-8.

* NOTICE

To prevent damaging the remote key:

- Keep the remote key away from water or any liquid and fire. If the inside of the remote key gets damp (due to

drinks or moisture), or is heated, internal circuit may malfunction, excluding the car from the warranty.

- Avoid dropping or throwing the remote key.
- Protect the remote key from extreme temperatures.

⚠ WARNING

Kia recommends to use parts for replacement from an authorised Kia dealer/service partner. If an aftermarket key is used, the ignition switch may not return to ON after START. If this happens, the starter will continue to operate causing damage to the starter motor and possible fire due to excessive current in the wiring.

Mechanical Key

If the remote key does not operate normally, you can lock or unlock the door by using the mechanical key.



To unfold the key:

- press the release button then the key will unfold automatically.

To fold the key:

- fold the key manually whilst pressing the release button.

⚠ CAUTION

Do not fold the key without pressing the release button. This may damage the key.

Transmitter precautions*** NOTICE**

The transmitter will not work if any of the following occurs:

- The ignition key is in the ignition switch.
- You exceed the operating distance limit (about 10 m [30 feet]).
- The battery in the transmitter is weak.
- Other vehicles or objects may be blocking the signal.
- The weather is extremely cold.
- The transmitter is close to a radio transmitter such as a radio station or an airport which can interfere with normal operation of the transmitter.

When the transmitter does not work correctly, open and close the door with the ignition key. If you have a problem with the transmitter Kia recommends to contact an authorised Kia dealer/service partner.

- If the transmitter is in close proximity to your cell phone or smart phone, the signal from the transmitter could be blocked by normal operation of your cell phone or smart phone. This is especially important when the phone is active such as making call, receiving calls, text messaging, and/or sending/receiving emails.

Avoid placing the transmitter and your cell phone or smart phone in the same pants or jacket pocket and

maintain adequate distance between the two devices.

⚠ CAUTION

Changes or modifications not expressly approved by the party responsible for compliance could void the user's authority to operate the equipment. If the keyless entry system is inoperative due to changes or modifications not expressly approved by the party responsible for compliance, it will not be covered by your manufacturer's vehicle warranty.

*** NOTICE**

Keep the remote key away from electromagnetic materials that blocks electromagnetic waves to the key surface.

Smart key (if equipped)

With a smart key, you can lock or unlock a door and start the engine without inserting the key.

Type A



Type B



Type C



Lock (1)

All doors are locked if the lock button is pressed whilst all doors are closed. The hazard warning lights will blink once to indicate that all doors are locked. However, if any door, engine bonnet or trunk/tailgate remains open, the hazard warning lights will not operate. If all doors, engine bonnet and trunk/tailgate are closed after the lock button is pressed, the hazard warning lights will blink once.

Unlock (2)

All doors are unlocked if the unlock button is pressed.

The hazard warning lights will blink twice to indicate that all doors are unlocked.

After pressing this button, the doors will lock automatically unless you open any door within 30 seconds.

When 2 Press Unlock function (if equipped) is activated,

- If you press the Unlock button (2) on the smart key, the driver's door will unlock.
- If you press the Unlock button (2) on the smart key within four seconds again, then all the doors will unlock.

You can activate or deactivate the 2 Press Unlock function by selecting 'User settings (LCD display) or Setup → Vehicle (Infotainment System screen) → Door → 2 Press Unlock'. (if equipped)

Trunk/tailgate unlock (3)

The trunk/tailgate is unlocked if the button is pressed for more than 1 second. The hazard warning lights will blink twice to indicate that the trunk/tailgate is unlocked. However, after pressing this button, the trunk/tailgate will lock automatically unless you open the trunk/tailgate within 30 seconds.

Once the trunk/tailgate is opened and then closed, the trunk/tailgate will lock automatically.

Remote start (4) (if equipped)

You can start the vehicle using the remote start button (4) of the smart key. To start the vehicle remotely:

- Lock the doors by pressing the door lock button (1) within 10 m (32 feet) distance from the vehicle.
- Press the remote start button for over 2 seconds within 4 seconds after locking the doors.

Press the remote start button once to turn off the vehicle.

If no further action for operating/driving the vehicle is taken, the vehicle will be turned off 10 minutes after starting the vehicle remotely.

⚠ CAUTION

- The remote start will not work if you exceed the operating distance limit (about 10 m).
- Avoid idling the engine for prolonged periods to obey the emission regulations in your country.
- Laws in your country may restrict the use of remote start.

You should check country regulations before using this remote starting system.

- The vehicle must be in P (Park) for the remote start function to start.
- If the bonnet or the trunk/tailgate is opened, you can't start the engine remotely.

Panic alarm (5) (if equipped)

1. Press the panic button (5) for more than 1 second.
2. The horn sounds and hazard warning light flash for about 27 seconds.

* NOTICE

To stop the horn and lights, press any button on the key.

Start-up

You can start the vehicle without inserting the key.

- * For more information, refer to "ENGINE START/STOP button (if equipped)" on page 6-11.

Mechanical Key

If the smart key does not operate normally, you can lock or unlock the door by using the mechanical key.

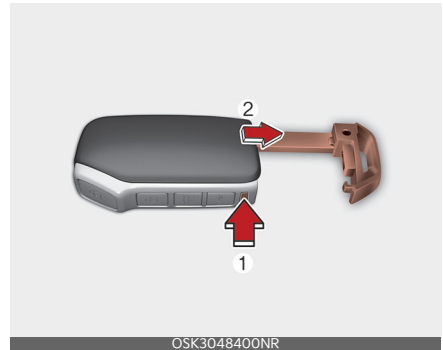

To pull out the mechanical key:

- press and hold the release button (1) and remove the mechanical key (2).

To reinstall the mechanical key:

- put the key into the hole and push it until a click sound is heard.

Smart key precautions

* NOTICE

- If, for some reason, you happen to lose your smart key, you will not be able to start the engine. Tow the vehicle, if necessary, contact a professional workshop. Kia recommends to contact an authorised Kia dealer/service partner.
- A maximum of 2 smart keys can be registered to a single vehicle. If you lose a smart key, Kia recommends to

contact an authorised Kia dealer/service partner.

- The smart key will not work if any of the following occurs:
 - The smart key is close to a radio transmitter such as a radio station or an airport which can interfere with normal operation of the smart key.
 - The smart key is near a mobile two-way radio system or a mobile phone.
 - Another vehicle's smart key is being operated close to your vehicle.

When the smart key does not work properly, open and close the door with the mechanical key. If you have a problem with the smart key, Kia recommends to contact an authorised Kia dealer/service partner.

⚠ CAUTION

Keep the smart key away from water or any liquid. If smart key is inoperative due to exposure to water or other liquids, it will not be covered by your manufacturer's vehicle warranty.

⚠ CAUTION

Changes or modifications not expressly approved by the party responsible for compliance could void the user's authority to operate the equipment. If the keyless entry system is inoperative due to changes or modifications not expressly approved by the party responsible for compliance, it will not be covered by your manufacturer's vehicle warranty.

Theft-alarm system (if equipped)

Theft-alarm system is designed to provide protection from unauthorised entry into the vehicle.

Vehicles equipped with a theft alarm system will have a label attached to the vehicle with the following words:

1. WARNING
2. SECURITY SYSTEM

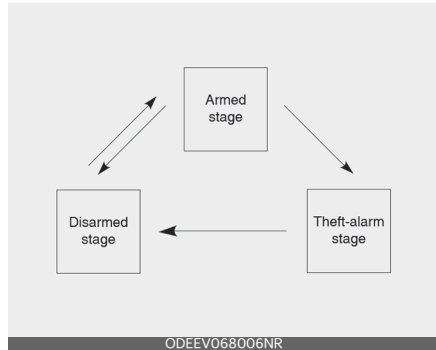

This system is operated in three stages:

- Armed stage
- Theft-alarm stage
- Disarmed stage

If triggered, the system provides an audible alarm with blinking of the hazard warning lights.

Armed stage

Theft Alarm System goes to Armed stage after 30 seconds from the doors are locked by switch on a Outside Door Handle/by a lock button on the Key.

Using the smart key

Park the vehicle and stop the engine. Arm the system as described below.

1. Turn off the engine.
2. Make sure that all doors (and trunk/ tailgate) and the engine bonnet are closed and latched.

3. Do one of the following:

- Lock the doors by pressing the button of the front outside door handle with the smart key in your possession.

After completion of the steps above, the hazard warning lights operate once to indicate that the system is armed.

If any door remains open, the doors won't lock and the chime will sound for 3 seconds. Close the door and try again to lock the doors.

If trunk/tailgate or engine bonnet remains open, the hazard warning lights won't operate and theft-alarm will not arm. After this, if the trunk/tailgate and engine bonnet are closed, the hazard warning lights will blink once.

- Lock the doors by pressing the lock button on the smart key. After completion of the steps above, the hazard warning lights will operate once to indicate that the system is armed.

If any door (and trunk/tailgate) or engine bonnet remains open, the hazard warning lights won't operate and theft-alarm will not arm. After this, if all doors (and trunk/tailgate) and engine bonnet are closed, the hazard warning lights blink once.

Using the remote key

Park the vehicle and stop the engine. Arm the system as described below.

1. Turn off the engine and remove the ignition key from the ignition switch.
2. Make sure that all doors (and trunk/tailgate), the engine bonnet are closed and latched.

3. Lock the doors by pressing the lock button on the remote key. After completion of the steps above, the hazard warning lights will blink once to indicate that the system is armed.

If any door (and trunk/tailgate) or engine bonnet remains open, the hazard warning lights won't operate and theft-alarm will not arm. After this, if all doors (and trunk/tailgate) and engine bonnet are closed, the hazard warning lights blink once.

Theft-alarm stage

The alarm will be activated if any of the following occurs whilst the system is armed.

- A door is opened without using the remote key or smart key.
- The trunk/tailgate is opened without using the remote key or smart key.
- The engine bonnet is opened.

The horn will sound and the hazard warning lights will blink continuously for approximately 30 seconds. To turn off the system, unlock the doors with the remote key or smart key.

Disarmed stage

The system will be disarmed when:

Remote key

- The door unlock button is pressed.
- The engine is started.
- The vehicle is in the "ON" position for 30 seconds or more.

Smart key

- The door unlock button is pressed.
- The button of the front outside door is pressed whilst carrying the smart key.
- The engine is started.

After the doors are unlocked, the hazard warning lights will blink twice to indicate that the system is disarmed.

After pressing the unlock button, if any door (or trunk/tailgate) is not opened within 30 seconds, the system will be rearmed.

* NOTICE

- If the system is not disarmed with the smart key, open the door with the mechanical key and start the engine. Then the system will be disarmed.
- If you lose your keys, Kia recommends to visit an authorised Kia dealer/service partner.

Immobiliser system

Your vehicle may be equipped with an electronic engine immobiliser system to reduce the risk of unauthorised vehicle use.

Your immobiliser system is comprised of a small transponder in the ignition switch and electronic devices inside the vehicle.

Vehicles without smart key system

With the immobiliser system, whenever you insert your ignition key into the ignition switch and turn it to ON, it checks and determines and verifies if the ignition key is valid or not.

If the key is valid, the engine will start.

If the key is invalid, the engine will not start.

To deactivate the immobiliser system:

Insert the ignition key into the key cylinder and turn it to the ON position.

To activate the immobiliser system:

Turn the ignition key to the OFF position. The immobiliser system activates automatically. Without a valid ignition key for your vehicle, the engine will not start.

Vehicles with smart key system

Whenever the ENGINE START/STOP buttons are changed to the ON position, the immobiliser system checks and verifies if the key is valid or not.

If the key is valid, the engine will start.

If the key is invalid, the engine will not start.

To deactivate the immobiliser system

Change the ENGINE START/STOP button to the ON position.

To activate the immobiliser system

Change the ENGINE START/STOP button to the OFF position. The immobiliser system activates automatically. Without a valid smart key for your vehicle, the engine will not start.

⚠ WARNING

In order to prevent theft of your vehicle, do not leave spare keys anywhere in your vehicle. Your immobiliser password is a customer unique password and should be kept confidential. Do not leave this number anywhere in your vehicle.

* NOTICE

When starting the engine, do not use the key with other immobiliser keys around. Otherwise the engine may not start or may stop soon after it starts. Keep each

key separately in order to avoid a starting malfunction.

⚠ CAUTION

Do not put metal accessories near the ignition switch. Metal accessories may interrupt the transponder signal and may prevent the engine from being started.

* NOTICE

If you need additional keys or lose your keys, Kia recommends to visit an authorised Kia dealer/service partner.

⚠ CAUTION

The transponder in your ignition key is an important part of the immobiliser system. It is designed to give years of trouble-free service, however you should avoid exposure to moisture, static electricity and rough handling. Immobiliser system malfunction could occur.

⚠ CAUTION

Do not change, alter or adjust the immobiliser system because it could cause the immobiliser system to malfunction. In this case, have the system serviced by a professional workshop. Kia recommends to visit an immobiliser Kia dealer/service partner.

Malfunctions caused by improper alterations, adjustments or modifications to the immobiliser system are not covered by your vehicle manufacturer warranty.

Door locks

Know how to use the door lock so that you can lock or unlock the door if necessary.

with the smart Key

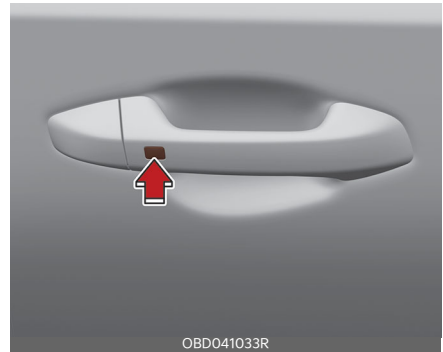

Carrying the smart key, you may lock and unlock the vehicle doors (and trunk/tailgate). Also, you may start the engine. Refer to the following for more details.

Locking

Pressing the button of the front driver side door handles with all doors closed and any door unlocked, locks all the doors. If all doors and engine bonnet are closed, the hazard warning lights will blink once to indicate that all doors are locked.

The button will only operate when the smart key is within 0.7~1 m (28~40 inches) from the driver side door handle. If you want to make sure that a door has locked or not, you should pull the driver side door handle.

Even though you press the driver side door handle buttons, the doors will not lock and the chime will sound for 3 seconds if any of following occur:

- The smart key is in the vehicle.
- The ENGINE START/STOP button is in the ACC or ON position.
- Any door except the trunk/tailgate is open.

Unlocking

Pressing the button of the front driver side door handles with all doors closed and locked, unlocks all the doors. The hazard warning lights blink twice to indicate that all doors are unlocked.

The button will only operate when the smart key is within 0.7~1 m (28~40 inches) from the front driver side door handle.

When the smart key is recognized in the area of 0.7~1 m (28~40 inches) from the front driver side door handle, other people can also open the door without possession of the smart key.

After pressing the button, the doors will lock automatically unless you open any door within 30 seconds.

When 2 Press Unlock function (if equipped) is activated,

- If you press the driver's outside door handle button, the driver's door will unlock.
- If you press the driver's outside door handle button within four seconds again, then all the doors will unlock.

You can activate or deactivate the 2 Press Unlock function by selecting 'User settings (LCD display) or Setup → Vehicle (Infotainment System screen) → Door → 2 Press Unlock'. (if equipped)

with the mechanical key

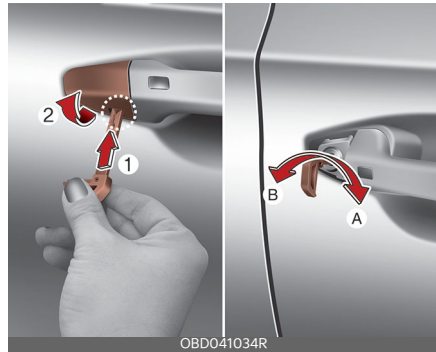

To remove the cover

1. Pull out the door handle.
 2. Press the lever (1) located inside the bottom part of the cover with a key or flat-head screwdriver.
 3. Push out the cover (2) whilst pressing the lever.
- Turn the key toward the rear of the vehicle to unlock and toward the front of the vehicle to lock.
 - If you Lock (A)/Unlock (B) the driver's door with a key, a driver's doors will lock/unlock.
 - Doors can also be locked and unlocked with the transmitter.
 - Once the doors are unlocked, they may be opened by pulling the door handle.
 - When closing the door, push the door by hand. Make sure the doors are closed securely.

* NOTICE

- When removing the cover, be careful not to lose cover and any scratches.
- When the key cover freezes and does not open, lightly tap or indirectly warm (hand temperature, etc.) it.

- Do not apply excessive force to the door and door handle. It may be damaged.
- If the door is locked/unlocked multiple times in rapid succession with either the vehicle key or door lock switch, the system may stop operating temporarily in order to protect the circuit and prevent damage to system components.

⚠ WARNING

- If you don't close the door securely, the door may open again.
- Be careful that someone's body and hands are not trapped when closing the door.

⚠ WARNING

If people must spend a longer time in the vehicle whilst it is very hot or cold outside, there is risk of injuries or danger to life. Do not lock the vehicle from the outside when there are people in it.

Operating door locks from inside the vehicle

You can operate door locks with the door lock handle or central door lock/unlock switch.

With the door handle

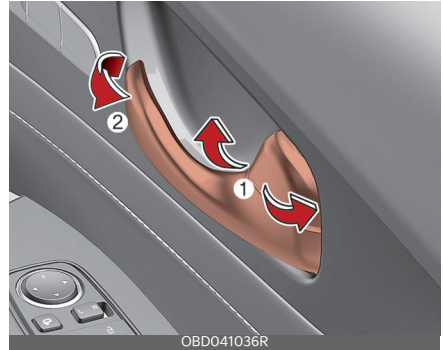

- To unlock a door, push the door lock button (1) to the "Unlock" position. The red mark on the handle will be visible.
- To lock a door, push the door lock button (1) to the "Lock" position. If the door is locked properly, the red mark on the door handle will not be visible.
- To open a door, pull the door handle (2) outward.
- If the inner door handle of the driver's (or front passenger's) door is pulled when the door lock button is in the lock position, the button will unlock and the door will open.
- Front doors cannot be locked if the ignition key is in the ignition switch and any front door is opened.
- Doors cannot be locked if the smart key is in the vehicle and an door is open.

⚠ WARNING

Door lock malfunction

If a power door lock ever fails to function whilst you are in the vehicle, try one or more of the following techniques to exit:

- Operate the door unlock feature repeatedly (both electronic and manual) whilst simultaneously pulling on the door handle.

- Operate the other door locks and handles, front and rear.
- Lower a front window and use the key to unlock the door from outside.
- Move to the cargo area and open the trunk/tailgate.

⚠ WARNING

Do not pull the inner door handle of driver's (or passenger's) door whilst the vehicle is moving.

With central door lock/unlock switch

Driver side

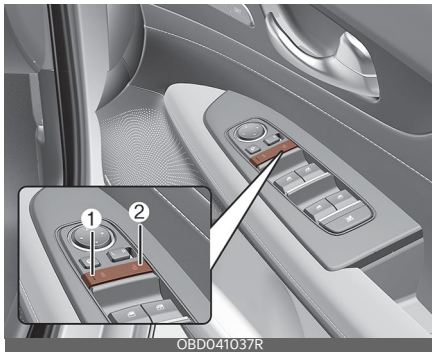

1. Door Lock
2. Door Unlock

Operate by pressing the central door lock/unlock switch.

- Press the switch to the "Lock" position (1), all vehicle doors will lock.
- Press the switch to the "Unlock" position (2), all vehicle doors will unlock.
- If the key is in the ignition switch (of if the smart key is in the vehicle) and any front door is opened, the doors will not lock when the "Lock" position (1) of the central door lock/unlock switch is pressed.

⚠ WARNING

Doors

- The doors should always be fully closed and locked whilst the vehicle is in motion to prevent accidental opening of the door. Locked doors will also discourage potential intruders when the vehicle stops or slows down.
- Be careful when opening doors and watch out for vehicles, motorcycles, bicycles or pedestrians approaching the vehicle in the path of the door. Opening a door when something is approaching can cause damage or injury.

⚠ WARNING

Unlocked vehicles

Leaving your vehicle unlocked can increase the risk of vehicle theft or any possible criminal harm caused by someone hiding in your vehicle while you are gone. Always remove the ignition key, engage the parking brake, close all windows and lock all doors when leaving your vehicle unattended.

⚠ WARNING

Unattended children, the elderly or pets

An enclosed vehicle can become extremely hot, causing death or severe injury such as heatstroke to unattended children, the elderly or pets who cannot escape the vehicle. When left or trapped in a hot vehicle, make sure to stay hydrated and avoid sun exposure through the vehicle's windscreen. Furthermore, children might operate features of the vehicle that could injure them, or they could encounter other harm, possibly from someone gaining

entry to the vehicle. Never leave children or animals unattended in your vehicle.

Door lock/unlock features

The vehicle is equipped with door lock/unlock features for the safety and convenience of passengers.

Impact sensing door unlock system (if equipped)

All doors will automatically unlock when an impact causes the air bags to deploy.

Speed sensing door lock system (if equipped)

All doors will automatically lock after the vehicle speed exceeds 15 km/h.

You can activate or deactivate the Auto door lock/unlock by selecting "User Settings (LCD display) or Settings → Vehicle (Infotainment System screen) → Door → Auto lock/Auto unlock".

Child-protector rear door lock

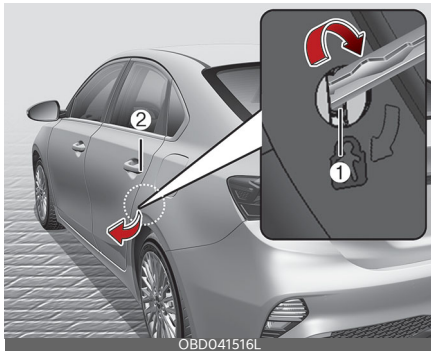

The child safety lock is provided to help prevent children from accidentally opening the rear doors from inside the vehicle. The rear door safety locks should be used whenever children are in the vehicle.

1. Open the rear door.
2. Insert a key (or screwdriver) into the hole (1) and turn it to the lock  position. When the child safety lock is in the lock position, the rear door will not open even though the inner door handle is pulled.

3. Close the rear door.

To open the rear door, pull the outside door handle (2).

Even though the doors may be unlocked, the rear door will not open by pulling the inner door handle until the rear door child safety lock is unlocked.

WARNING

Rear door locks

If children accidentally open the rear doors whilst the vehicle is in motion, they could fall out and be severely injured or killed. To prevent children from opening the rear doors from the inside, the rear door safety locks should be used whenever children are in the vehicle.

Rear Occupant Alert (ROA) system (if equipped)

The Rear Occupant Alert (ROA) system is provided to help prevent exiting the vehicle with the rear passenger left in the vehicle.

- When you open the front door after opening and closing the rear door and turning off the engine, the "Check rear seats" warning message appears on the cluster.

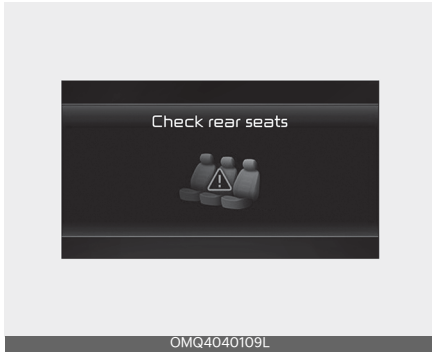

You can activate or deactivate the Rear Occupant Alert by selecting 'User Settings (LCD display) or Settings → Vehicle (Infotainment System screen) → Convenience → Rear Occupant Alert'.

⚠ WARNING

The Rear Occupant Alert (ROA) system does not actually detect objects or people in the rear seat. By using a rear door opened and closed history, the system informs the driver that there may be something in the rear seat.

⚠ CAUTION

The Rear Occupant Alert (ROA) system uses a rear door opened and closed history.

The history is reset after the driver turns off ignition normally, exits the vehicle and locks the door remotely using the remote keyless entry. So even if a rear door does not reopen, the ROA system alert can occur.

For example, after the ROA system alert occurs, if the driver do not lock the door, and drive again, the alert can occur.

Safe Exit Warning (SEW) (if equipped)

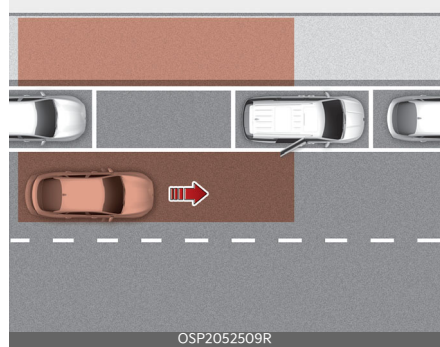

After the vehicle stops, when an approaching vehicle from the rear area is detected as soon as a passenger opens a door, Safe Exit Warning will warn the driver with a warning message and an audible warning to help prevent a collision.

⚠ CAUTION

The timing of the warning may vary depending on the speed of the approaching vehicle.

Detecting sensor

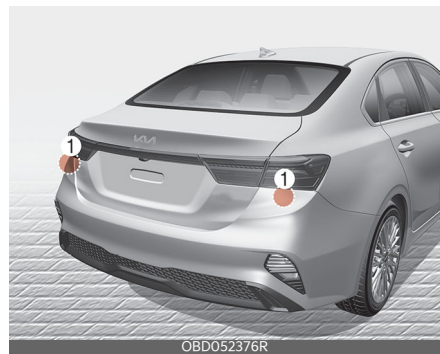

[1] : Rear corner radar

Refer to the picture above for the detailed location of the detecting sensors.

*** NOTICE**

For more details on the precautions of the rear corner radars, refer to "Blind-Spot Collision-Avoidance Assist (BCA) (if equipped)" on page 6-94.

Safe Exit Warning settings

Safe Exit Warning

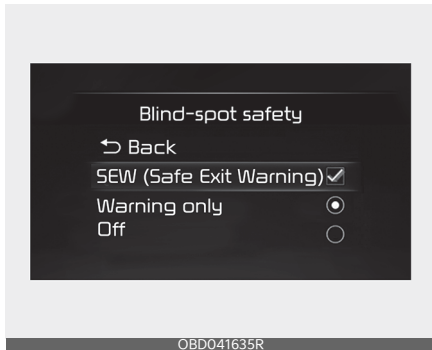

With the ignition switch or the ENGINE START/STOP button in the ON position, and select 'User Settings (LCD display) or Settings → Vehicle (Infotainment System screen) → Driver assistance → Blind-spot safety → SEW (Safe Exit Warning)' to turn on Safe Exit Warning and deselect to turn off.

⚠ WARNING

If 'Safe Exit Warning' is deselected, the function cannot assist you.

*** NOTICE**

If the engine is restarted, Safe Exit Warning will maintain the last setting.

Warning volume

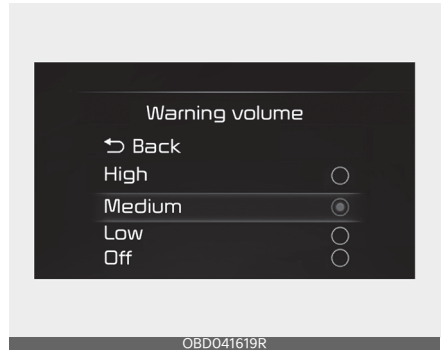

With the ENGINE START/STOP button in the ON position, and select 'User Settings (LCD display) or Settings → Vehicle (Infotainment System screen) → Driver assistance → Warning Methods → Warning volume to change the warning volume to 'High', 'Medium' 'Low' or 'Off'(if equipped) for Safe Exit Warning. However, even if 'Off' is selected, the Warning volume of Safe Exit Warning. will not turn off but the volume will sound as 'Low'.

If you change the warning volume, the warning volume of other Driver Assistance functions may change. Set the warning volume after you learn it sufficiently.

⚠ CAUTION

The setting of the Warning volume applies to all functions of the Safe Exit Warning.

Safe Exit Warning operation

Safe Exit Warning warning

Collision warning when exiting vehicle

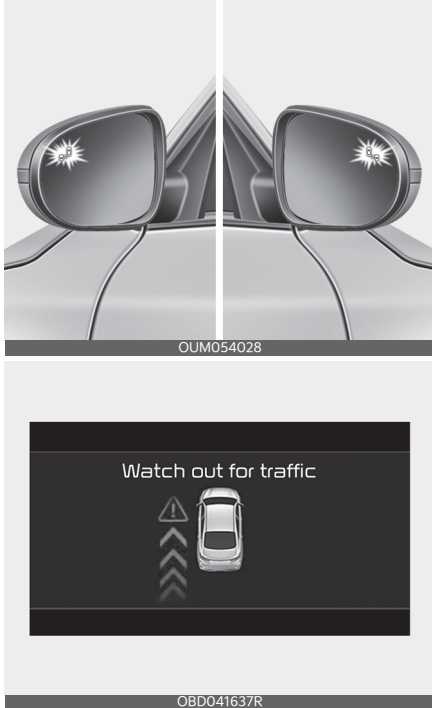

- When an approaching vehicle from the rear is detected at the moment a door is opened, the 'Watch out for traffic' warning message will appear on the cluster, the warning light will illuminate on the outside rear view mirror and an audible warning will sound.
- Safe Exit Warning will warn the driver when your vehicle speed is below 3km/h (2mph), and the speed of the approaching vehicle from the rear is above 6 km/h (4 mph).

WARNING

- For your safety, change the Settings after parking the vehicle at a safe location.
- If any other function's warning message is displayed or audible warning is generated, Safe Exit Warning message may not be displayed and audible warning may not be generated.
- You may not hear the warning sound of Safe Exit Warning if the surrounding is noisy.
- Safe Exit Warning does not operate in all situations or cannot prevent all collisions.
- Safe Exit Warning may warn the driver late or may not warn the driver depending on the road and driving conditions. Always check vehicle surroundings.
- Safe Exit Warning does not operate if there is a problem with Blind-Spot Collision Warning or Blind-Spot Collision-Avoidance Assist.
 - The warning message of Blind-Spot Collision Warning or Blind-Spot Collision-Avoidance Assist will appear when:
 - The warning message of Blind-Spot Safety system appears on the cluster.
 - Blind-Spot Collision Warning or Blind-Spot Collision-Avoidance Assist sensor or the sensor surrounding is polluted or covered
 - Blind-Spot Collision Warning or Blind-Spot Collision-Avoidance Assist fails to warn passengers or prematurely warn passengers

*** NOTICE**

After the engine is turned off, Safe Exit Warning operates approximately for 3 minutes, but turns off immediately if the doors are locked.

Safe Exit Warning malfunction and limitations

Safe Exit Warning malfunction

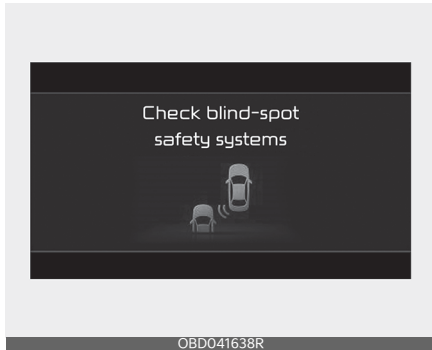

When Blind-Spot Collision Warning or Blind-Spot Collision-Avoidance Assist is not working properly, the 'Check blind-spot safety system' warning message will appear on the cluster, and the function will turn off automatically or the function will be limited. In this case, have the vehicle inspected by a professional workshop. Kia recommends to visit an authorised Kia dealer/service partner.

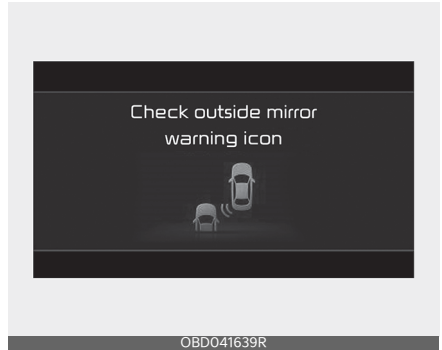

When the outside rear view mirror warning light is not working properly, the 'Check outside mirror warning icon' warning message will appear on the cluster. In this case, have the vehicle inspected by a professional workshop. Kia recommends to visit an authorised Kia dealer/service partner.

Safe Exit Warning disabled

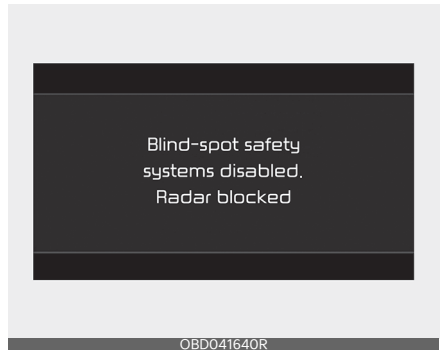

When the rear bumper around the rear corner radar or sensor is covered with foreign matters, such as snow or rain, or installing a trailer or carrier, it can reduce the detecting performance and temporarily limit or disable Safe Exit Warning. If this occurs, the 'Blind-spot safety systems disabled. Radar blocked' warning message will appear on the cluster. The function will operate normally when

4

such foreign matters or trailer, etc. is removed, and then the engine is restarted.

If the function does not operate normally after it is removed, have the vehicle inspected by a professional workshop. Kia recommends to visit an authorised Kia dealer/service partner.

WARNING

- Even though the warning message does not appear on the cluster, Safe Exit Warning may not properly operate.
- Safe Exit Warning may not properly operate in an area (e.g. open terrain) where any substance are not detected right after the engine is turned on, or when the detecting sensor is blocked with foreign matters right after the engine is turned on.

CAUTION

Turn off Safety Exit Warning to install a trailer, carrier, etc., or remove the trailer, carrier, etc. to use Safety Exit Warning.

Limitations of Safe Exit Warning

Safety Exit Warning may not operate normally, or the function may operate unexpectedly under the following circumstances:

- Driving through a narrow road where trees or grass or overgrown
- Driving on a wet road surface, such as a puddle in the road
- The speed of the other vehicle is very fast or slow that it passes by your vehicle in a short time

CAUTION

For more details on the limitations of the rear corner radar, refer to "Blind-Spot Collision-Avoidance Assist (BCA) (if equipped)" on page 6-94.

WARNING

- Safety Exit Warning may not operate normally if interfered by strong electromagnetic waves.
- Safety Exit Warning may not operate for 3 seconds after the vehicle is started, or the rear corner radars are initialized.

Trunk(For 4door)

Opening the trunk

1. Make sure the shift lever is in P (Park, for Automatic Transmission/Dual Clutch Transmission/ Intelligent Variable Transmission) or first gear or R (Reverse, for Manual Transmission) and set the parking brake.

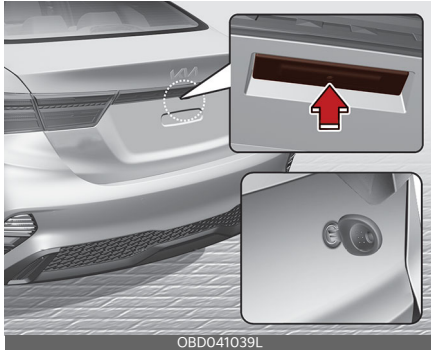

2. Then do one of the following :

- Press the Remote key or Smart Key Trunk Unlock button for more than one second.
- Press the button on the trunk itself with the Smart Key in your possession.
- Use the mechanical key. (if equipped with key hole)



- To open the trunk from inside the vehicle, pull the trunk release lever.

⚠ WARNING

The trunk swings upward. Make sure no objects or people are near the rear of the vehicle when opening the trunk.

⚠ CAUTION

Make certain that you close the trunk before driving your vehicle. Possible damage may occur to the attached hardware if the trunk is not closed prior to driving.

*** NOTICE**

In cold and wet climates, trunk lock and trunk mechanisms may not work properly due to freezing conditions.

Closing the trunk

Lower the trunk lid and press down until it locks. To be sure the trunk lid is securely fastened, always check by trying to pull it up again.

*** NOTICE**

If the trunk is closed with the smart key in it, the chime will sound for approximately 3 seconds and the trunk will reopen.

⚠ WARNING

The trunk lid should be always kept completely closed whilst the vehicle is in motion. If it is left open or ajar, poisonous exhaust gases may enter the car and serious illness or death may result.

⚠ WARNING**Exhaust fumes**

If you drive with the trunk open, you will draw dangerous exhaust fumes into your vehicle which can cause serious injury or death to vehicle occupants. If you must drive with the trunk open, keep the air vents and all windows open so that additional outside air comes into the vehicle.

⚠ WARNING**Rear cargo area**

Occupants should never ride in the rear cargo area where no restraints are available. To avoid injury in the event of an accident or sudden stops, occupants should always be properly restrained.

Emergency trunk safety release

Your vehicle is equipped with an emergency trunk release lever located inside the trunk. If someone is inadvertently locked in the trunk, moving the handle in the direction of the arrow will release the trunk latch mechanism and open the trunk.

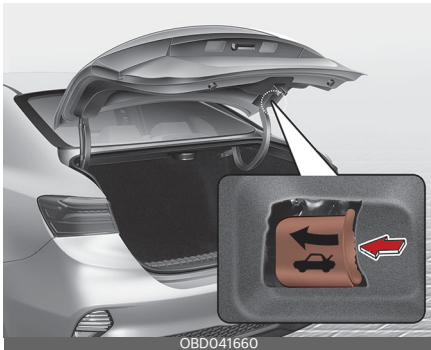
**⚠ WARNING**

- You and your passengers must be aware of the location of the Emergency Trunk Safety Release lever in this vehicle and how to open the trunk in case you are accidentally locked in the trunk.
- NEVER allow anyone to occupy the trunk of the vehicle at any time. If the trunk is partially or totally latched and the person is unable to get out, serious injury or death could occur due to lack of ventilation, exhaust fumes and rapid heat build-up, or because of exposure to cold weather conditions. The trunk is also a highly dangerous location in the event of a crash because it is not a protected occupant space but is a part of the vehicle's crush zone.
- Your vehicle should be kept locked and the Smart Key should be kept out of the reach of children. Parents should teach their children about the dangers of playing in trunks.
- Use the release lever for emergencies only.

Smart Trunk(For 4door) (if equipped)

On a vehicle equipped with a smart key, the trunk can be opened using the Smart Trunk system.

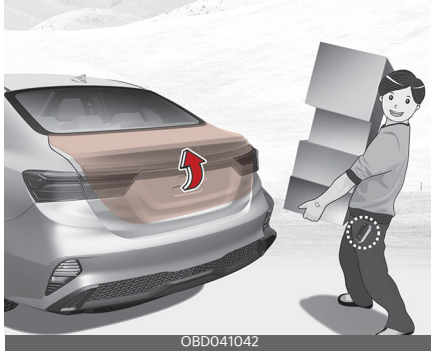

How to use the Smart Trunk

The trunk can be opened with no-touch activation satisfying all the conditions below.

- After 15 seconds when all doors are closed and locked
- Positioned in the detecting area for more than 3 seconds.

* NOTICE

The Smart Trunk does not operate when:

- The smart key is detected within 15 seconds after the doors are closed and locked, and is continuously detected.
- The smart key is detected within 15 seconds after the doors are closed and locked, and 1.5 m from the front door handles. (for vehicles equipped with Welcome Light)
- A door is not locked or closed.
- The smart key is in the vehicle.

1. Setting

You can activate or deactivate the Smart Trunk by selecting 'User Settings (LCD display) or Settings → Vehicle (Infotainment System screen) → Door → Smart Trunk'.

2. Detect and Alert

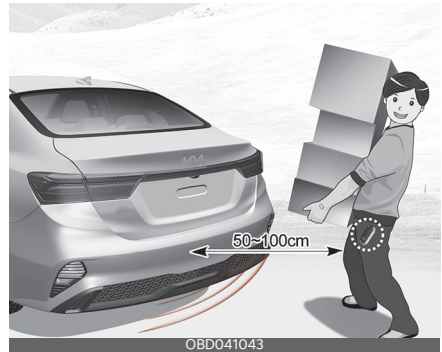

If you are positioned in the detecting area (50 ~100 cm behind the vehicle) carrying a smart key, the hazard warning lights will blink and chime will sound to alert you the smart key has been detected and the trunk will open.

* NOTICE

Do not approach the detecting area if you do not want the trunk to open. If you have unintentionally entered the detecting area and the hazard warning lights and chime starts to operate, leave the detecting area with the smart key. The trunk will stay closed.

3. Automatic opening

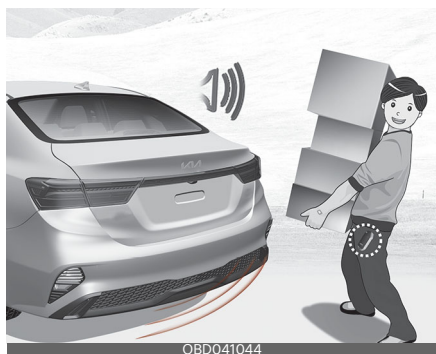

The hazard warning lights will blink and chime will sound 2 times and then the trunk will open.

⚠ WARNING

- Make sure you close the trunk before driving your vehicle.
- Make sure there are no people or objects around the trunk before opening or closing the trunk.
- Make sure objects in the trunk do not come out when opening the trunk on a slope. It may cause serious injury.
- Make sure to deactivate the Smart Trunk when washing your vehicle. Otherwise, the trunk may open inadvertently.
- The key should be kept out of reach of children. Children may inadvertently open the Smart Trunk whilst playing around the rear area of the vehicle.

How to deactivate the Smart Trunk function using the smart key



1. Door lock
2. Door unlock
3. Trunk open
4. Remote start(if equipped)

If you press any button of the smart key during the Detect and Alert stage, the Smart Trunk function will be deactivated.

Make sure to be aware of how to deactivate the Smart Trunk function for emergency situations.

*** NOTICE**

- If you press the door unlock button (2), the Smart Trunk function will be deactivated temporarily. But, if you do not open any door for 30 seconds, the Smart Trunk function will be activated again.
- If you press the trunk open button (3) for more than 1 second, the trunk opens.
- If you press the door lock button (1) or trunk open button (3) when the Smart Trunk function is not in the Detect and Alert stage, the Smart Trunk function will not be deactivated.

- In case you have deactivated the Smart Trunk function by pressing the smart key button and opened a door, the Smart Trunk function can be activated again by closing and locking all doors.
- The detecting range may decrease or increase when :
 - One side of the tyre is raised to replace a tyre or to inspect the vehicle.
 - The vehicle is slantingly parked on a slope or unpaved road, etc.

Detecting area

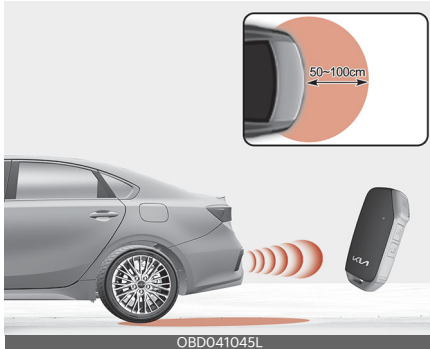

- The Smart Trunk operates with a welcome alert if the smart key is detected within 50~100 cm from the trunk.
- The alert stops at once if the smart key is positioned outside the detecting area during the Detect and Alert stage.

* NOTICE

- The Smart Trunk function will not work if any of the following occurs:
 - The smart key is close to a radio transmitter such as a radio station or an airport which can interfere with normal operation of the transmitter.
 - The smart key is near a mobile two way radio system or a mobile phone.
 - Another vehicle's smart key is being operated close to your vehicle.

Tailgate(For 5door)

Opening the tailgate



Make sure the vehicle is in P(Park) and set the parking brake. Then do one of the following:

- Unlock all doors with the door unlock button on your remote key or smart key. Press the tailgate handle button and open the tailgate.
- Press and hold the Tailgate Unlock button on the remote key or smart key. Press the tailgate handle button and open the tailgate.
- With the Smart Key in your possession, press the tailgate handle button and open the tailgate.

* NOTICE

In cold and wet climates, door lock and door mechanisms may not work properly due to freezing conditions.

⚠ WARNING

The tailgate swings upward. Make sure no objects or people are near the rear of the vehicle when opening the tailgate.

⚠ CAUTION

Make certain that you close the tailgate before driving your vehicle. Possible damage may occur to the tailgate gas lifters and attaching hardware if the tailgate is not closed prior to driving.

Closing the tailgate



Lower and push down the tailgate firmly. Make sure that the tailgate is securely latched.

⚠ WARNING

Make sure your hands, feet and other parts of your body are safely out of the way before closing the tailgate.

⚠ CAUTION

Make sure nothing is near the tailgate latch and striker whilst closing the tailgate. It may damage the tailgate's latch.

⚠ WARNING

Exhaust fumes

If you drive with the tailgate open, you will draw dangerous exhaust fumes into your vehicle which can cause serious injury or death to vehicle occupants. If you must drive with the tailgate open,

keep the air vents and all windows open so that additional outside air comes into the vehicle. The tailgate lid should be always kept completely closed whilst the vehicle is in motion. If it is left open or ajar, poisonous exhaust gases may enter the car and serious illness or death may result.

⚠ WARNING

Rear cargo area

Occupants should never ride in the rear cargo area where no restraints are available. To avoid injury in the event of an accident or sudden stops, occupants should always be properly restrained.

⚠ WARNING



Do not grasp the part supporting the tailgate (gas lifter), as this may cause serious injury.

Emergency tailgate safety release

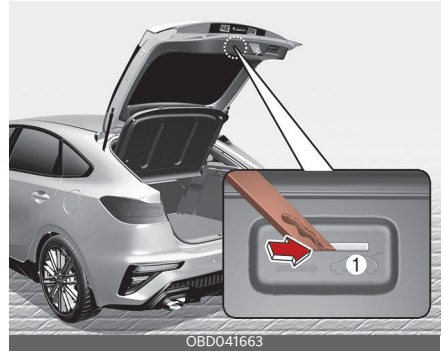

Your vehicle is equipped with the emergency tailgate safety release lever located on the bottom of the tailgate. When someone is inadvertently locked in the luggage compartment, the tailgate can be opened by doing as follows:

1. Input the mechanical key into the hole.
2. Push the mechanical key to the right (1).
3. Push up the tailgate.

⚠ WARNING

- For emergencies, be fully aware of the location of the emergency tailgate safety release lever in the vehicle and how to open the tailgate if you are accidentally locked in the luggage compartment.
- No one should be allowed to occupy the luggage compartment of the vehicle at any time. The luggage compartment is a very dangerous location in the event of a crash.
- Use the release lever for emergencies only. Use with extreme caution, especially whilst the vehicle is in motion.

Windows

The doors of this vehicle are equipped with power windows that can be operated by a switch.

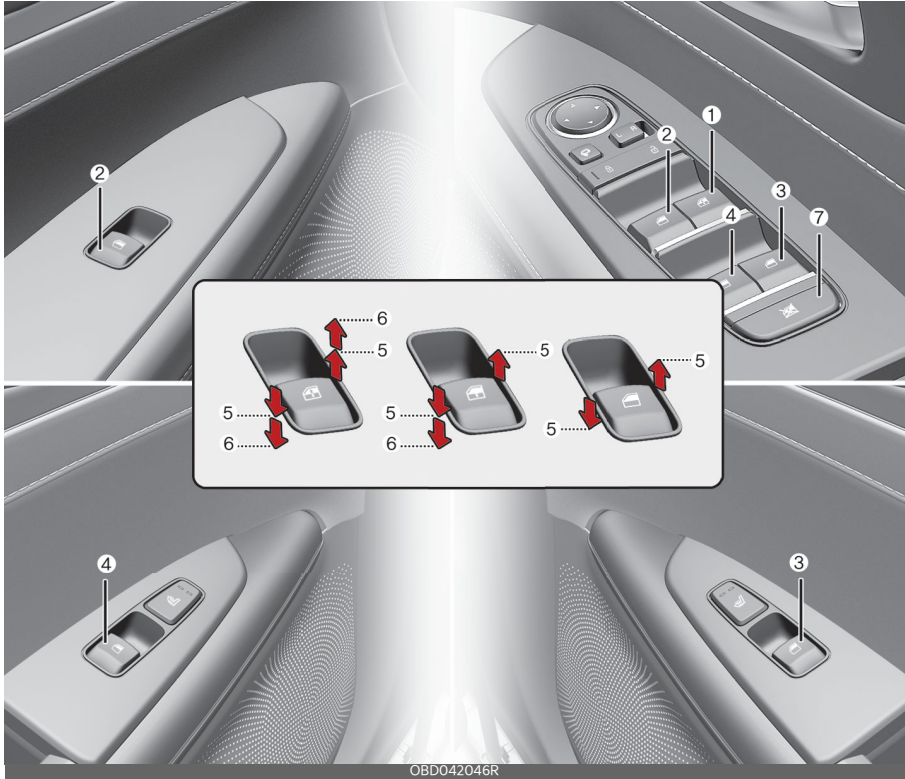

1. Driver's door power window switch
2. Front passenger's door power window switch
3. Rear door (right) power window switch
4. Rear door (left) power window switch
5. Window opening and closing
6. Automatic power window up*/down*
7. Power window lock button

*: if equipped

* NOTICE

In cold and wet climates, power windows may not work properly due to freezing conditions.

The ignition switch or ENGINE START/ STOP button must be in the ON position for power windows to operate.

Each door has a power window switch that controls the door's window. The driver has a power window lock button which can block the operation of rear passenger windows. The power windows can be operated for approximately 3 minutes after ignition switch or ENGINE START/STOP button turned to the ACC or LOCK position. However, if the front doors are opened, the power windows cannot be operated even within the 3 minutes period.

The driver's door has a master power window switch that controls all the windows in the vehicle. If the window cannot be closed because it is blocked by objects, remove the objects and close the window.

*** NOTICE**

Whilst driving with the rear windows down or with the sunroof (if equipped) in an open (or partially open position), your vehicle may demonstrate a wind buffeting or pulsation noise. This noise is a normal occurrence and can be reduced or eliminated by taking the following actions. If the noise occurs with one or both of the rear windows down, partially lower both front windows approximately 3 cm (1 inch). If you experience the noise with the sunroof open, slightly reduce the size of the sunroof opening.

⚠ WARNING

Do not install any accessories in the area of windows. It may impact jam protection.

Window opening and closing

You can open and close windows using the power window switch.

Type A



OBD042084R

To open or close a window, press down or pull up the front portion of the corresponding switch to the first detent position (5).

Type B - Auto down window (if equipped)

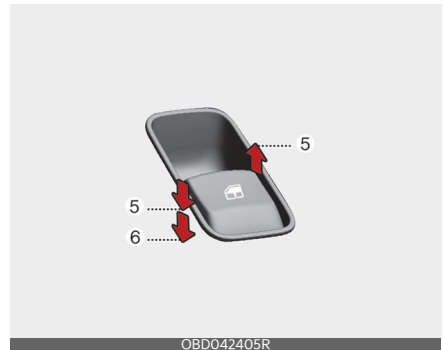

OBD042405R

Pressing the power window switch momentarily to the second detent position (6) completely lowers the window even when the switch is released.

To stop the window at the desired position whilst the window is in operation,

pull up the switch momentarily to the opposite direction of the window movement.

Type C - Auto up/down window (if equipped)

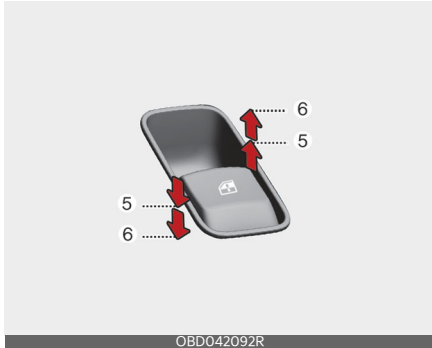

Pressing or pulling up the power window switch momentarily to the second detent position (6) completely lowers or raises the window even when the switch is released. To stop the window at the desired position whilst the window is in operation, pull up or press down and release the switch.

To reset the power windows

If the power window does not operate normally, the automatic power window system must be reset as follows:

1. Turn the ignition switch or ENGINE START/STOP button to the ON position.
2. Close the window and continue pulling up the power window switch for at least 1 second after the window is completely closed.

Automatic reversal (for Type C) (if equipped)

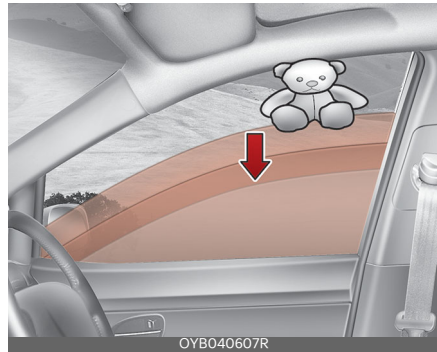

If the upward movement of the window is blocked by an object or part of the body, the window will detect the resistance and will stop upward movement. The window will then lower approximately 30 cm (11.8 inches) to allow the object to be cleared.

If the window detects the resistance whilst the power window switch is pulled up continuously, the window will stop upward movement then lower approximately 2.5 cm (1 inch).

And if the power window switch is pulled up continuously again within 5 seconds after the window is lowered by the automatic window reversal feature, the automatic window reversal will not operate.

* NOTICE

The automatic reverse feature for the window is only active when the "auto up" feature is used by fully pulling up the switch. The automatic reverse feature will not operate if the window is raised using the halfway position on the power window switch.

⚠ WARNING

Always check for obstructions before raising any window to avoid injuries or vehicle damage. If an object less than 4 mm (0.16 of an inch) in diameter is caught between the window glass and the upper window channel, the automatic reverse window may not detect the resistance and will not stop and reverse direction.

⚠ WARNING

The automatic reverse feature is not activated whilst resetting power window system.

Make sure body parts or other objects are safely out of the way before closing the windows to avoid injuries or vehicle damage.

Power window lock button

The driver can disable the power window switches on the rear passengers' doors by pressing the power window lock button to the lock position (pressed).

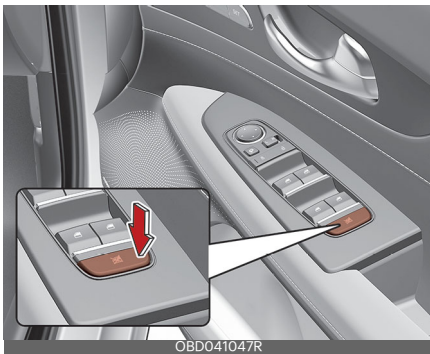

When the power window lock button is pressed:

- The driver's master control can operate all passengers' power windows.

- The front passenger's control can operate the front passenger's power window.
- The rear passengers' control cannot operate the rear passenger's power window.

⚠ CAUTION

- To prevent possible damage to the power window system, do not open or close two windows or more at the same time. This will also ensure the longevity of the fuse.
- Never try to operate the main switch on the driver's door and the individual door window switch in opposite directions at the same time. If this is done, the window will stop and cannot be opened or closed.

Remote window closing/opening system (if equipped)



You can still control the windows movement with the engine turned off.

- Press the door lock button (1) for more than 3 seconds. The window moves up after the doors are locked, as long as you press the door lock button (1).

The window movement stops, when you release the door lock button (1).

- Press the door unlock button (2) for more than 3 seconds. The window moves down after the doors are unlocked, as long as you press the door unlock button (2).

The window movement stops, when you release the door unlock button (2).

You can activate or deactivate the remote window closing/opening system by selecting 'User settings (LCD display) or Setup → Vehicle (Infotainment System screen) → Door → Remote window control'.

CAUTION

- The remote window closing/opening function may abruptly stop, when you move away from your vehicle during operation. Stay in close proximity from your vehicle, whilst monitoring the window movement.
- One of the windows may stop operating, when the window is interrupted by certain force. However, the other windows will keep operating.
Thus, you should make sure that all windows are closed.
- Be careful when using the remote window opening function, as the doors will be unlocked.

WARNING

Windows

- NEVER leave the keys in your vehicle with unsupervised children, when the engine is running.
- NEVER leave any child unattended in the vehicle. Even very young children may inadvertently cause the vehicle to move, entangle themselves in the windows, or otherwise injure themselves or others.

- Always double check to make sure all arms, hands, head and other obstructions are safely out of the way before closing a window.
- Do not allow children play with the power windows. Keep the driver's door power window lock button in the LOCK position (pressed). SERIOUS INJURY can result from unintentional window operation by the child.
- Do not extend heads or any limbs outside the window whilst the vehicle is in motion.

Bonnet

The bonnet serves as a cover for the engine compartment.

Open the bonnet if maintenance work needs to be performed in the engine compartment or if you need to look at the compartment.

Opening the bonnet

1. Pull the release lever to unlatch the bonnet. The bonnet should pop open slightly.

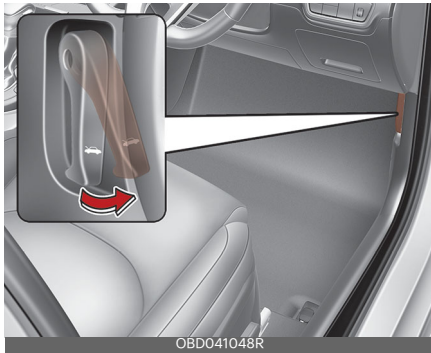

WARNING

Open the bonnet after turning off the engine on a flat surface, shifting the shift lever to the P (Park, for Automatic Transmission/Dual Clutch Transmission/ Intelligent Variable Transmission) or first gear or R (Reverse, for Manual Transmission) and set the parking brake.

2. Go to the front of the vehicle, raise the bonnet slightly, push the secondary hood release lever (1) up side and lift the bonnet (2).

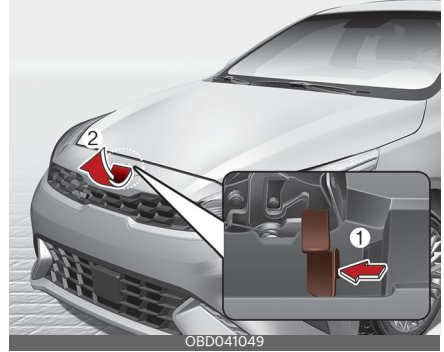

3. Pull out the support rod.
4. Hold the bonnet opened with the support rod(3).



WARNING

Hot parts

Grasp the support rod in the area wrapped in rubber. The rubber will help prevent you from being burned by hot metal when the engine is hot.

Bonnet open warning (if equipped)

The bonnet warning message will appear on the LCD display when bonnet is open.



The warning chime will operate when the vehicle is being driven at or above 3 km/h (2 mph) with the bonnet open.

Closing the bonnet

1. Before closing the bonnet, check the following:
 - All filler caps in the engine compartment must be correctly installed.
 - Gloves, rags or any other combustible material must be removed from the engine compartment.
2. Return the support rod to its clip to prevent it from rattling.
3. Lower the bonnet until it is about 30 cm above the closed position and let it drop. Make sure that it locks into place.



4. Check that the bonnet has engaged properly.
 - If the bonnet can be raised slightly, it is not properly engaged.
 - Open it again and close it with a little more force.

⚠ WARNING

- Before closing the bonnet, ensure that all obstructions are removed from the bonnet opening. Closing the bonnet with an obstruction present in the bonnet opening may result in property damage or severe personal injury.
- Do not leave gloves, rags or any other combustible material in the engine compartment. Doing so may cause a heat-induced fire.

⚠ WARNING

- Always double check to be sure that the bonnet is firmly latched before driving away. If it is not latched, the bonnet could open while the vehicle is being driven, causing total loss of visibility, which might result in an accident.
- Do not move the vehicle with the bonnet raised. The view will be blocked and the bonnet could fall or be damaged.

Fuel filler door

Opening the fuel filler door

4 Door



5 Door



vehicle to a warm place and allow the ice to melt.

4 Door



5 Door



The fuel-filler door must be opened from inside the vehicle by pulling up on the fuel-filler door opener located on the front floor area on the driver's seat.

* NOTICE

If the fuel filler door does not open because ice has formed around it, tap lightly or push on the door to break the ice and release the door. Do not pry on the door. If necessary, spray around the door with an approved de-icer fluid (do not use radiator anti-freeze) or move the

1. Stop the engine.
2. To open the fuel filler door, pull up the fuel filler door opener.
3. Pull open the fuel filler door (1).
4. To remove the cap, turn the fuel filler cap (2) counterclockwise.
5. Refuel as needed.

⚠ WARNING

Before refuelling, be sure to check what type of fuel is used for your vehicle.

If you put diesel fuel into a petrol-powered vehicle or petrol into a diesel-powered

ered vehicle, it may affect the fuel system and cause serious damage to the vehicle.

Closing the fuel filler door

1. To install the cap, turn it clockwise until it "clicks". This indicates that the cap is securely tightened.
2. Close the fuel filler door and push it lightly and make sure that it is securely closed.

WARNING

Refuelling

- If pressurized fuel sprays out, it can cover your clothes or skin and subject you to the risk of fire and burns. Always remove the fuel cap carefully and slowly. If the cap is venting fuel or if you hear a hissing sound, wait until the condition stops before completely removing the cap.
- Do not "top off" after the nozzle automatically shuts off when refuelling.
- Always check that the fuel cap is installed securely to prevent fuel spillage in the event of an accident.

WARNING

Refuelling dangers

Automotive fuels are flammable materials. When refuelling, please note the following guidelines carefully. Failure to follow these guidelines may result in severe personal injury, severe burns or death by fire or explosion.

- Read and follow all warning posted at the gas station facility.
- Before refuelling note the location of the Emergency petrol Shut-Off, if available, at the gas station facility.

- Before touching the fuel nozzle, you should eliminate potentially dangerous static electricity discharge by touching another metal part of the vehicle, a safe distance away from the fuel filler neck, nozzle, or other gas source.
- Do not get back into a vehicle once you have begun refuelling since you can generate static electricity by touching, rubbing or sliding against any item or fabric (polyester, satin, nylon, etc.) capable of producing static electricity. Static electricity discharge can ignite fuel vapours resulting in rapid burning. If you must reenter the vehicle, you should once again eliminate potentially dangerous static electricity discharge by touching a metal part of the vehicle, away from the fuel filler neck, nozzle or other petrol source.
- When using an approved portable fuel container, be sure to place the container on the ground prior to refuelling. Static electricity discharge from the container can ignite fuel vapours causing a fire.

Once refuelling has begun, contact with the vehicle should be maintained until the filling is complete.

Use only approved portable plastic fuel containers designed to carry and store petrol.

- Do not use mobile phones whilst refuelling. Electric current and/or electronic interference from mobile phones can potentially ignite fuel vapours causing a fire.
- When refuelling, always shut the engine off. Sparks produced by electrical components related to the engine can ignite fuel vapours caus-

ing a fire. Once refuelling is complete, check to make sure the filler cap and filler door are securely closed, before starting the engine.

- DO NOT use matches or a lighter and DO NOT SMOKE or leave a lit cigarette in your vehicle whilst at a gas station especially during refuelling. Automotive fuel is highly flammable and can result in fire when ignited.
- If a fire breaks out during refuelling, leave the vicinity of the vehicle, and immediately contact the manager of the gas station and then contact the local fire department. Follow any safety instructions they provide.

⚠ CAUTION

- Make sure to refuel your vehicle according to the "Fuel requirements" on page 1-2.
- If the fuel filler cap requires replacement, please make sure that you use parts designed for replacement in your vehicle. An incorrect fuel filler cap can result in a serious malfunction of the fuel system or emission control system. For more detailed information, Kia recommends to contact an authorised Kia dealer/service partner.
- Do not spill fuel on the exterior surfaces of the vehicle. Any type of fuel spilled on painted surfaces may damage the paint.
- After refuelling, make sure the fuel cap is installed securely to prevent fuel spillage in the event of an accident.

Sunroof (if equipped)

If your vehicle is equipped with a sunroof, you can slide or tilt your sunroof with the sunroof switch located on the overhead console.



The sunroof can only be operated when the ignition switch or the ENGINE START/STOP button is in the ON or START position. The sunroof can be operated for approximately 3 minutes after the ignition switch or the ENGINE START/STOP button is in the ACC or LOCK/OFF position. However, if the front door is open, the sunroof cannot be operated even within the 3 minutes period.

⚠ WARNING

- Adjust the sunroof or sunshade when your vehicle stops. This could result in loss of control and an accident that may cause injury, or property damage.
- Do not leave the engine running and the key in your vehicle with unsupervised children. Unattended children could operate the sunroof, which could result in serious injury.
- Do not sit on the top of the vehicle. It may cause injury or vehicle damage.

*** NOTICE**

Do not operate the sunroof when roof bars are installed on the vehicle or when there is luggage on the roof.

Sunshade



OBD041544

Use the sunshade to block direct sunlight coming through the sunroof glass. Open or close the sunshade by hand.

*** INFORMATION**

The sunshade opens automatically when the sunroof glass is opened, but the sunshade does not close automatically when the sunroof glass is closed. Also, only the sunshade cannot be closed when the sunroof glass is opened.

*** NOTICE**

Do not pull the sunshade up or down, or apply excessive force as such action may damage the sunshade or cause it to malfunction.

Tilt open/close

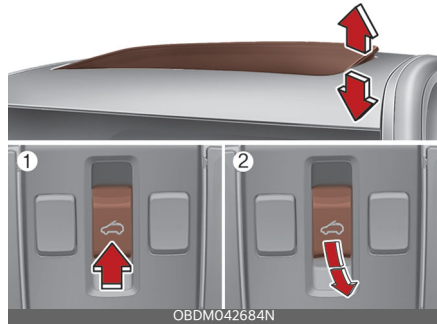

OBDM042684N

1. Tilt open
 2. Tilt close
- Push the sunroof switch upward, the sunroof glass tilts open.
 - Push the sunroof switch forward when the sunroof glass is tilted open, the sunroof glass closes.

The sunroof glass tilts open or closes whilst the switch is pushed.

*** INFORMATION**

The sunroof glass cannot slide open and tilt open at the same time. You cannot tilt the sunroof glass open whilst the sunroof glass is slide open. Also, you cannot slide the sunroof glass open whilst the sunroof is tilt open. Slide open or tilt open the sunroof glass when the sunroof glass is completely closed.

Slide open/close

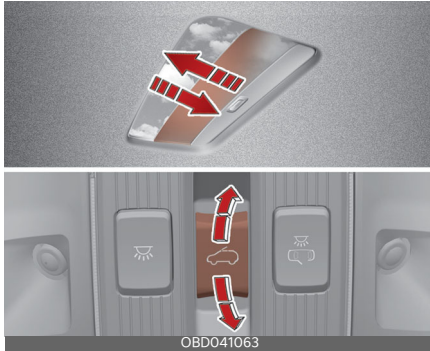

- Push the sunroof switch rearward, the sunshade and sunroof glass slide open.
Push the sunroof switch forward, only the sunroof glass close.
- Push the sunroof switch forward or rearward to the first detent position, the sunroof glass moves until the switch is released.
- Push the sunroof switch forward or rearward to the second detent position, the sunroof glass operates automatically (auto slide feature). To stop the sunroof movement at any point, push the sunroof switch in any direction.
- The sunroof glass stops halfway (first detent position) before it is fully opened. To fully open the sunroof glass, push the sunroof switch rearward once more. At this time, the sunroof glass opens only whilst the switch is pushed.

* INFORMATION

To reduce wind noise whilst driving, we recommend that you drive at the recommended position (first detent position) before the maximum slide open position.

Automatic reversal



If the sunroof glass senses any obstacle whilst it is closing automatically, it will reverse direction then stop at a certain position. The auto reverse function may not work if an object thin or soft is caught between the sliding sunroof glass and sunroof sash.

⚠ WARNING

- Make sure heads, hands, arms or any other body parts or objects are out of the way before operating the sunroof. Body parts or objects may get caught causing injuries or vehicle damage.
- Never deliberately use your body parts to test the automatic reversal function. The sunroof glass may reverse direction, but there is a risk of injury.

* NOTICE

- Do not continue to push the sunroof switch after the sunroof is fully opened, closed, or tilted. Damage to the sunroof motor could occur.
- Continuous operations such as slide open/close, tilt open/close, etc. may cause the motor or sunroof system to malfunction.

- Regularly remove any accumulated dust on the sunroof rail.
- Dust accumulated between the sunroof and roof panel can make noise. Open the sunroof and remove dust regularly using a clean cloth.
- Do not try to open the sunroof when the temperature is below freezing or when the sunroof is covered with snow or ice. The sunroof may not work properly and may break if opened by force.
- Do not open or drive with the sunroof glass open immediately after rain or washing the vehicle. Water may wet the interior of the vehicle.
- Do not extend any luggage outside the sunroof whilst driving. Vehicle damage may occur if the vehicle suddenly stops.

⚠ WARNING

Do not extend your head, arms, body parts or objects outside the sunroof whilst driving. Injuries may occur if the vehicle suddenly stops.

Resetting the sunroof



In some circumstances resetting the sunroof operation may need to be per-

formed. Some instances where resetting the sunroof may be required include:

- When the 12-volt battery is either disconnected or discharged
- When the sunroof fuse is replaced
- If the sunroof one-touch AUTO OPEN/CLOSE operation is not functioning properly

Sunroof resetting procedure:

1. It is recommended to perform the reset procedure with the vehicle engine running. Start the vehicle in P (Park).
2. Make sure the sunroof glass is in the fully closed position. If the sunroof glass is open, push the switch forward until the sunroof glass is fully closed.
3. Release the switch when the sunroof glass is fully closed.
4. Push the switch forward until the sunroof glass moves slightly. Then release the switch.
5. Once again push and hold the sunroof switch forward until the sunroof glass slides open and close. Do not release the switch until the operation is completed.

If you release the switch during operation, start the procedure again from step 2.

*** INFORMATION**

If the sunroof does not reset when the vehicle battery is disconnected or discharged, or the sunroof fuse is blown, the sunroof may not operate normally.

Sunroof open warning



If the driver turns off the engine when the sunroof is not fully closed, the warning chime will sound for several seconds and the sunroof open warning will appear on the cluster LCD display. Close the sunroof securely when leaving your vehicle.

⚠ CAUTION

Make sure the sunroof is closed fully when leaving your vehicle. If the sunroof is left open, rain or snow may wet the interior of the vehicle. Also, leaving the sunroof open when the vehicle is unattended may invite theft.

Steering wheel

The steering wheel of this vehicle is equipped with the Motor Driven Power Steering (MDPS) system.

Motor Driven Power Steering (MDPS)

Power steering uses the motor to assist you in steering the vehicle.

If the engine is off or if the power steering system becomes inoperative, the vehicle may still be steered, but it will require increased steering effort.

The MDPS is controlled by the power steering control unit which senses the steering wheel torque and vehicle speed to command the motor.

The steering effort becomes heavier as the vehicle's speed increases and becomes lighter as the vehicle's speed decreases for better control of the steering wheel.

Should you notice any change in the effort required to steer during normal vehicle operation, have the system checked by a professional workshop. Kia recommends to visit an authorised Kia dealer/service partner.

* NOTICE

The following symptoms may occur during normal vehicle operation:

- The MDPS warning light does not illuminate.
- The steering effort is high immediately after turning the ignition switch or ENGINE START/STOP button on. This happens as the MDPS system performs the diagnostics. When the diagnostics is completed, the steering effort will return to its normal condition.

- A click noise may be heard from the MDPS relay after the ignition switch or ENGINE START/STOP button is turned to the ON or LOCK position.
- Motor noise may be heard when the vehicle is at a stop or at a low driving speed.
- When the abnormality is detected in the motor driven power steering system, a deadly accident prevention purposes, steering assist functions will be stopped. At this time, the instrument panel warning light turns on or blinks and the power to manipulate the steering will be off. Please check immediately after moving the vehicle to a safe zone.
- The steering effort increases if the steering wheel is rotated continuously when the vehicle is not in motion. However, after a few minutes, it will return to its normal conditions.
- If the Motor Driven Power Steering System does not operate normally, the warning light will illuminate on the instrument cluster. The steering wheel may become difficult to control or operate abnormally. In this case, have the system inspected by a professional workshop. Kia recommends to visit an authorised Kia dealer/service partner.
- When you operate the steering wheel in low temperature, abnormal noise could occur. If temperature rises, the noise will disappear. This is a normal condition.

Tilt & telescopic steering wheel

A tilt and telescopic steering wheel allows you to adjust the steering wheel before you drive. You can also raise it to

give your legs more room when you exit and enter the vehicle.

The steering wheel should be positioned so that it is comfortable for you to drive, whilst permitting you to see the instrument panel warning lights and gauges.

⚠ WARNING

- Never adjust the angle of the steering wheel whilst driving. You may lose steering control and cause severe personal injury, death or accidents.
- After adjusting, push the steering wheel both up and down to be certain it is locked in position.

Adjusting steering wheel angle and height

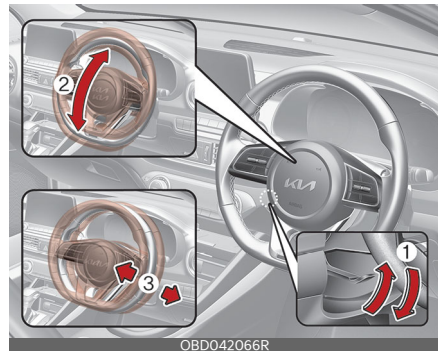

1. To change the steering wheel angle, pull down the lock release lever (1).
2. Adjust the steering wheel to the desired angle (2) and height (3). Move the steering wheel, so it points toward your chest, not toward your face. Make sure you can see the instrument panel warning lights and gauges. After adjusting, pull up the lock.
3. Pull up the lock-release lever to lock the steering wheel in place. Push the steering wheel both up and down to be certain it is locked in position.

4. Be sure to adjust the steering wheel to the desired position before driving.

*** NOTICE**

After adjustment, sometimes the lock-release lever may not lock the steering wheel.

It is not a malfunction. This occurs when two gears engage. In this case, adjust the steering wheel again and then lock the steering wheel.

Heated steering wheel (if equipped)

When the ignition switch is in the ON position or the ENGINE START/STOP button is in the ON position, pressing the heated steering wheel button warms the steering wheel. The indicator on the button will illuminate.

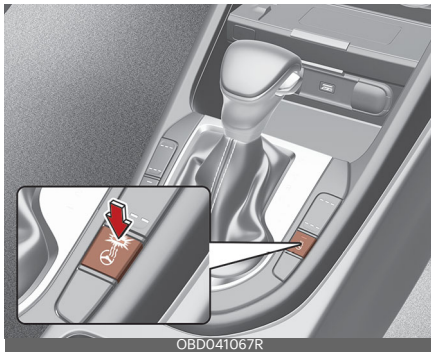

To turn the heated steering wheel off, press the button once again. The indicator on the button will turn off.

*** NOTICE**

The heated steering wheel will turn off automatically approximately 30 minutes after the heated steering wheel is turned on.

⚠ CAUTION

- Do not install any type of grip cover for the steering wheel, it may impair the function of the heated steering wheel system.
- When cleaning the heated steering wheel, do not use an organic solvent such as paint thinner, benzene, alcohol and petrol. Doing so may damage the surface of the steering wheel.
- If the surface of the steering wheel is damaged by a sharp object, damage to the heated steering wheel components could occur.

⚠ WARNING

If the steering wheel becomes too warm, turn the system off. The heated steering wheel may cause burns even at low temperatures, especially if used for long periods of time.

Horn

To sound the horn, press the area indicated by the horn symbol on your steering wheel (see illustration).



The horn will operate only when this area is pressed. Check the horn regularly to be sure it operates properly.

⚠ CAUTION

- Do not strike the horn severely to operate it, or hit it with your fist. Do not press on the horn with a sharp-pointed object.
 - When cleaning the steering wheel, do not use an organic solvent such as thinner, benzene, alcohol and petrol. Doing so may damage the steering wheel.
-

Mirrors

This vehicle is equipped with inside and outside rear view mirrors to provide views of objects behind the vehicle.

Inside rear view mirror

Adjust the rear view mirror so that the centre view through the rear window is seen.

Make this adjustment before you start driving.

⚠ WARNING**Rear visibility**

Do not place objects in the rear seat or cargo area which would interfere with your vision out the rear window.

⚠ WARNING

Do not adjust the rear view mirror whilst the vehicle is moving. This could result in loss of control, and an accident which could cause DEATH, SERIOUS INJURY, or property damage.

⚠ WARNING

Do not modify the inside mirror and don't install a wide mirror. It could result in injury, during an accident or deployment of the air bag.

Day/night rear view mirror (if equipped)

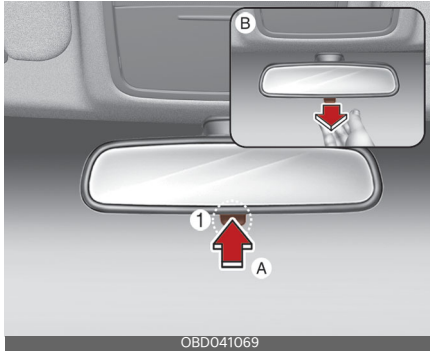

(A): Day, (B): Night

Make this adjustment before you start driving and whilst the day/night lever (1) is in the day position (A).

Pull the day/night lever (1) toward you (B) to reduce the glare from the headlights of the vehicles behind you during night driving.

Remember that you lose some rear view clarity in the night position.

Electric Chromic Mirror (ECM) (if equipped)

The electric rear view mirror automatically controls the glare from the headlights of the vehicles behind you in nighttime or low light driving conditions. The sensor mounted in the mirror senses the light level around the vehicle, and automatically controls the headlight glare from the vehicles behind you. When the engine is running, the glare is automatically controlled by the sensor mounted in the rearview mirror. Whenever the shift lever is shifted into reverse (R), the mirror will automatically go to the brightest setting in order to improve the drivers view behind the vehicle.

⚠ CAUTION

When cleaning the mirror, use a paper towel or similar material dampened with glass cleaner. Do not spray glass cleaner directly on the mirror. It may cause the liquid cleaner to enter the mirror housing.

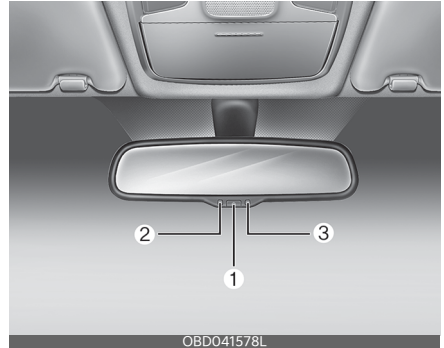

To operate the electric rearview mirror:

- The mirror defaults to the ON position whenever the ignition switch is turned on.
- Press the ON/OFF button (1) to turn the automatic dimming function off. The mirror indicator light (2) will turn off.
- Press the ON/OFF button (1) to turn the automatic dimming function on. The mirror indicator light (2) will illuminate.

* (2) : Indicator, (3) : Sensor

When the engine is running, the glare is automatically controlled by the sensor mounted in the rear view mirror.

Outside rear view mirror

Your vehicle is equipped with both left-hand and right-hand outside rear view mirrors.

Be sure to adjust the mirror angles before driving.

The mirrors can be adjusted remotely with the control levers or remote switch, depending on the type of mirror control installed. The mirror heads can be folded back to prevent damage during an automatic car wash or when passing through a narrow street.

⚠ WARNING

Rear view mirrors

- The outside rear view mirror is convex. Objects seen in the mirror are closer than they appear.
- Use your interior rear view mirror or direct observation to determine the actual distance of following vehicles when changing lanes.

⚠ CAUTION

Do not scrape ice off the mirror face; this may damage the surface of the glass. If ice should restrict the movement of the mirror, do not force the mirror for adjustment. To remove ice, use a deicer spray, or a sponge or soft cloth with warm water.

⚠ CAUTION

If the mirror is jammed with ice, do not adjust the mirror by force. Use an approved spray de-icer (not radiator antifreeze) to release the frozen mechanism or move the vehicle to a warm place and allow the ice to melt.

⚠ WARNING

Do not adjust or fold the outside rear view mirrors whilst the vehicle is moving. This could result in loss of control, and an accident which could cause DEATH, SERIOUS INJURY, or property damage.

Adjusting the outside rear view mirrors

The electric remote control mirror switch allows you to adjust the position of the left and right outside rear view mirrors.

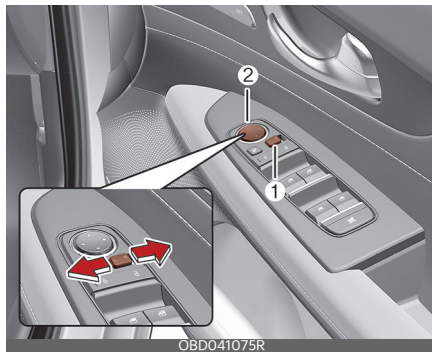

Adjusting the rear view mirrors:

1. Move the R or L switch (1) to select the right side mirror or the left side mirror.
2. Press a corresponding point (▲) on the mirror adjustment control (2) to position the selected mirror up, down, left or right.

⚠ CAUTION

- The mirrors stop moving when they reach the maximum adjusting angles, but the motor continues to operate whilst the switch is pressed. Do not press the switch longer than necessary, the motor may be damaged.
- Do not attempt to adjust the outside rear view mirror by hand. Doing so may damage the parts.
- When the mirror control, press exactly "▲" (2) marking area. Otherwise, the mirror will move to unintended direction or malfunction.

Folding the outside rearview mirror

Manual type (if equipped)

To fold the outside rear view mirror, grasp the housing of the mirror and then fold it toward the rear of the vehicle.



Electric type (if equipped)

To fold the outside rear view mirror depress the button. To unfold it, depress the button again.

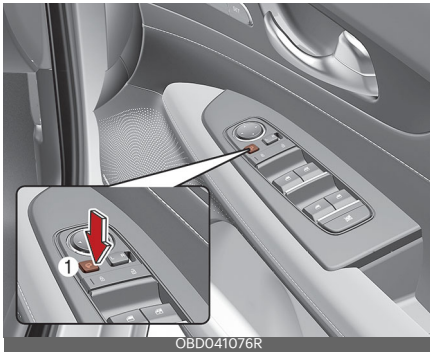

- With remote key and smart key
 - The mirror will fold or unfold when the door is locked or unlocked by the remote key or the smart key. (if equipped)
- With smart key
 - The mirror will fold or unfold when the door is locked or unlocked by the button on the outside door handle (if equipped).
 - The mirror will unfold when you approach the vehicle (all doors closed and locked) with a smart key in possession (if equipped).
- Auto folding function
 - For Type A cluster (segment)
 - If you press the outside mirror folding button (1) 5 seconds more, the function will be On or Off. When you turn on the function, the warning sound will be heard once and turn off the function, the warning sound will be heard twice.
 - The function is On by default.
 - For Type B cluster (supervision)
 - You can activate or deactivate the function by selecting 'User Settings (LCD display) or Settings → Vehicle (Infotainment System screen) → Convenience → Welcome mirror/light'.

⚠ CAUTION

The electric type outside rear view mirror operates even though the ignition switch or ENGINE START/STOP button is in the LOCK or OFF position. However, to prevent unnecessary battery discharge, do not adjust the mirrors longer than necessary whilst the engine is not running.

⚠ CAUTION

In case it is an electric type outside rear view mirror, don't fold it by hand. It could cause motor failure.

Instrument cluster

Type A



Type B



1. Tachometer
2. Speedometer
3. Engine coolant temperature gauge
4. Fuel gauge
5. Warning and indicator lights
6. LCD display

* The actual cluster in the vehicle may differ from the illustration. For more details, refer to the "Gauges" on page 4-54.

Instrument Cluster Control

Adjusting Instrument Cluster Illumination (if equipped)

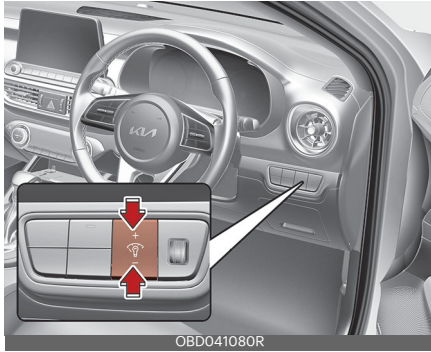

⚠ WARNING

Never adjust the instrument cluster whilst driving. This could result in loss of control and lead to an accident that may cause death, serious injury, or property damage.

The brightness of the instrument panel illumination is changed by pressing the illumination control button (“+” or “-”) when ignition switch or the ENGINE START/STOP button is ON, or the tail lights are turned on.

Type A



Type B



- If you hold the illumination control button (“+” or “-”), the brightness will be changed continuously.
- If the brightness reaches to the maximum or minimum level, an alarm will sound.

LCD Display Control

Type A



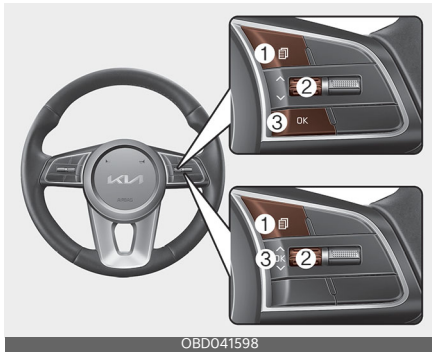

Type B



The LCD display modes can be changed by using the control buttons on the steering wheel.

- Type A
 1. TRIP: TRIP button for changing modes.
 2. RESET: RESET button for resetting the selected item.

- Type B
 1. : MODE button for change the LCD MODES
 2. : MODE scroll switch for select the items
 3. OK: SET/RESET button for the set the items or reset the items

Gauges

Speedometer

Type A



Type B



Type C



The speedometer indicates the speed of the vehicle and is calibrated in miles per hour (mph) and/or kilometers per hour (km/h).

Tachometer



The tachometer indicates the approximate number of engine revolutions per minute (rpm).

Use the tachometer to select the correct shift points and to prevent lugging and/or over-revving the engine.

CAUTION

Do not operate the engine within the tachometer's RED ZONE. This may cause severe engine damage.

Engine Coolant Temperature Gauge

Except Europe



For Europe



This gauge indicates the temperature of the engine coolant when the ignition switch or the ENGINE START/STOP button is ON.

CAUTION

If the gauge pointer moves beyond the normal range area (between the C-H or 50-130) toward the "130 or H" position, it indicates overheating that may damage the engine.

Do not continue driving with an overheated engine. If your vehicle overheats,

refer to "If the engine overheats" on page 7-6.

⚠ WARNING

Never remove the radiator cap when the engine is hot. The engine coolant is under pressure and could severely burn. Wait until the engine is cool before adding coolant to the reservoir.

Fuel Gauge

Except Europe



For Europe



This gauge indicates the approximate amount of fuel remaining in the fuel tank.

*** NOTICE**

- The fuel tank capacity is given in "Recommended lubricants and capacities" on page 9-10.
- The fuel gauge is supplemented by a low fuel warning light, which will illuminate when the fuel tank is nearly empty.
- On inclines or curves, the fuel gauge pointer may fluctuate or the low fuel warning light may come on earlier than usual due to the movement of fuel in the tank.

⚠ WARNING

Fuel Gauge

Running out of fuel can expose vehicle occupants to danger.

You must stop and obtain additional fuel as soon as possible after the warning light comes on or when the gauge indicator comes close to the "0 or E (Empty)" level.

⚠ CAUTION

Avoid driving with an extremely low fuel level. Running out of fuel could cause the engine to misfire damaging the catalytic converter.

Odometer

Type A

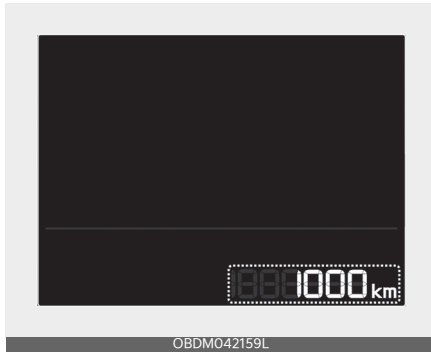

Type B



Distance to empty

Type A

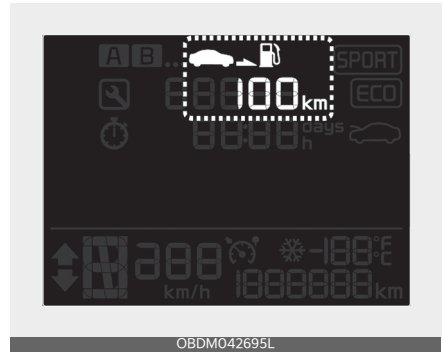

Type B



The odometer Indicates the total distance that the vehicle has been driven and should be used to determine when periodic maintenance should be performed.

- Odometer range: 0 ~ 1,599,999 km or 0 ~ 999,999 mi

- The distance to empty is the estimated distance the vehicle can be driven with the remaining fuel.
 - Distance range: 1 ~ 9,999 km or 1 ~ 9,999 mi.
- If the estimated distance is below 1 km (1 mi.), the trip computer will display "---" as distance to empty.

⚠ CAUTION

- If the vehicle is not on level ground or the battery power has been interrupted, the distance to empty function may not operate correctly.

- The distance to empty may differ from the actual driving distance as it is an estimate of the available driving distance.
- The trip computer may not register additional fuel if less than 6 litres (1.6 gallons) of fuel are added to the vehicle.
- The distance to empty may vary significantly based on driving conditions, driving habits, and condition of the vehicle.

Outside Temperature

Type A



Type B



This gauge indicates the current outside air temperatures by 1°C (1°F).

- Temperature range: -40°C ~ 60°C (-40°F ~ 140°F)

The outside temperature on the display may not change immediately like a general thermometer to prevent the driver from being inattentive.

The temperature unit (from °C to °F or from °F to °C) can be changed by:

- Type A Cluster

Press the TRIP button for 5 seconds, the Fuel Economy unit is blink. Press the TRIP button again, the temperature unit is blink. And then press the RESET button, the temperature unit is changed. Press the TRIP button for more than one second.

- Type B Cluster

- User Settings mode in the Cluster (if equipped) : You can change the temperature unit in the "Other - Temperature unit".

* For more details, refer to "LCD display" on page 4-62.

- Settings menu in the Infotainment System screen (if equipped) : You can change the temperature unit in the "Settings → Vehicle → Unit → Temperature unit → °C/°F".

* For detailed information, scan the QR code in a separately supplied Car Infotainment System Quick Reference Guide.

- Climate control system (for Automatic climate control system): whilst pressing the OFF button, press the AUTO button for 3 seconds or more. The temperature unit of the instrument cluster and cli-

mate control system will change at once.

Transmission Shift Indicator

Intelligent variable transmission Shift indicator (if equipped)

This indicator displays which automatic transmission shift lever is selected.

Type A



Type B



- Park: P
- Reverse: R
- Neutral: N
- Drive: D
- Sports Mode: 1, 2, 3, 4, 5, 7, 8

Automatic Transmission Shift Indicator (if equipped)

Type A



Type B



This indicator displays which automatic transmission gear is selected.

- Park: P
- Reverse: R
- Neutral: N
- Drive: D
- Sports Mode: 1, 2, 3, 4, 5, 6

Automatic Transmission Shift Indicator in Sports Mode (if equipped)

In the Sports Mode, this indicator informs which gear is desired whilst driving to save fuel.

- Shifting up:
 - ▲₂, ▲₃, ▲₄, ▲₅, ▲₆
- Shifting down:
 - ▼₁, ▼₂, ▼₃, ▼₄, ▼₅

For example

▲₃: Indicates that shifting up to the 3rd gear is desired (currently the shift lever is in the 2nd or 1st gear).

▼₄: Indicates that shifting down to the 4th gear is desired (currently the shift lever is in the 5th or 6th gear).

When the system is not working properly, the indicator is not displayed.

Manual Transmission Shift Indicator (if equipped)

Type A



Type B



This indicator informs which gear is desired whilst driving to save fuel.

- Shifting up:
 - ▲₂, ▲₃, ▲₄, ▲₅, ▲₆
- Shifting down:
 - ▼₁, ▼₂, ▼₃, ▼₄, ▼₅

For example

▲₃: Indicates that shifting up to the 3rd gear is desired (currently the shift lever is in the 2nd or 1st gear).

▼₄: Indicates that shifting down to the 4th gear is desired (currently the shift lever is in the 5th or 6th gear). When the system is not working properly, the indicator is not displayed.

Dual clutch transmission shift indicator (if equipped)

Type A

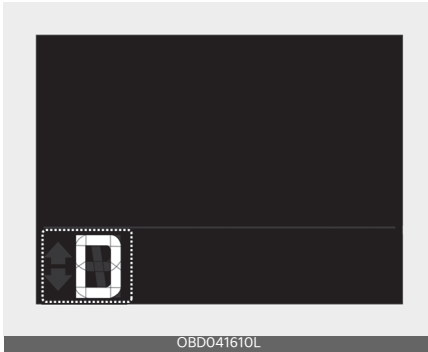

Type B









This indicator displays which shift lever is selected.

- Park: P
- Reverse: R
- Neutral: N
- Drive: D1, D2, D3, D4, D5, D6, D7
- Sports Mode: S1, S2, S3, S4, S5, S6, S7

LCD display

LCD display modes (for Type B cluster)

		 Mode				
		 Driving Assist	 Trip Computer	 Turn By Turn (TBT)*	 User Settings*	 Master warning
^ v Up/ Down			Drive Info	Route Guidance	Driver Assistance	The Master Warning mode displays warning messages related to the vehicle when one or more systems is not operating normally.
	Lane Keeping Assist/Smart Cruise Control/Lane Following Assist	Since Refuelling	Destination Info		Cluster	
		Accumulated Info			Lights	
		Digital Speedometer			Door	
	Driver Attention Warning				Convenience	
					Units	
					Language	
				Reset		

The information provided may differ depending on which functions are applicable to your vehicle.

* For controlling the LCD modes, refer to "LCD Display Control" on page 4-53".

Driving Assist mode

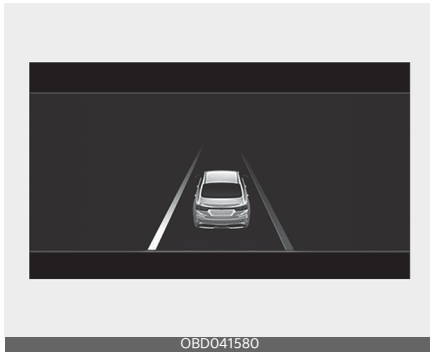

- Lane Keeping Assist (if equipped)
 - Lane Following Assist (if equipped)
 - Smart Cruise Control (if equipped)
 - Driver Attention Warning (if equipped)
- * For more details, refer to each system information in "Driving your vehicle" on page 6-6.

Setting (if equipped)

To change the Driver Assistance settings, press the OK button on the steering wheel for more than 1 second when the Driving Assist mode is displayed.

WARNING

Whilst driving, please do not change the setting mode. It may distract your attention and cause the accident.

Trip computer mode

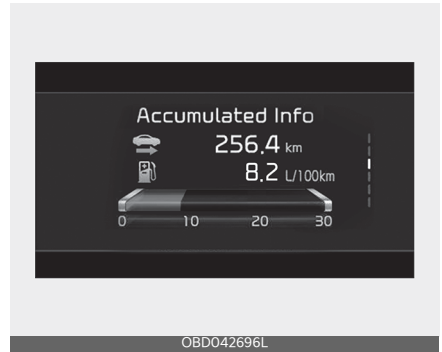

The trip computer mode displays information related to vehicle driving parameters including Accumulated info, Driving information, and so on.

* For more details, refer to "Trip Computer (if equipped)" on page 4-74.

Turn By Turn mode (if equipped)

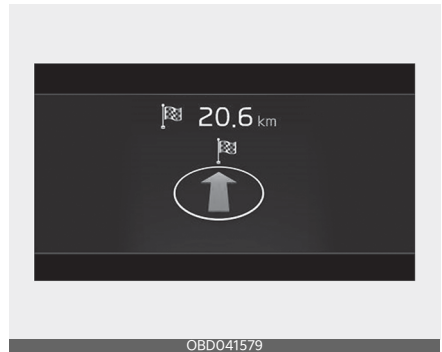

This mode displays the state of the navigation.

Master warning mode

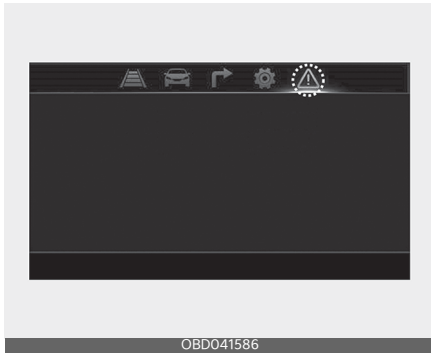

This warning light informs the driver the following situations.

- Forward Collision-Avoidance Assist malfunction (if equipped)
- Forward Collision-Avoidance Assist radar blocked (if equipped)
- Blind-Spot Collision Warning malfunction (if equipped)
- Blind-Spot Collision Warning radar blocked (if equipped)
- High Beam Assist malfunction (if equipped)
- Smart Cruise Control malfunction (if equipped)
- Smart Cruise Control radar blocked (if equipped)
- LED headlamp malfunction (if equipped)
- TPMS failure, low pressure (if equipped), etc.

At this time, a Master Warning icon (⚠) will appear on the LCD display. If the warning situation is solved, the master warning light will be turned off and the Master Warning icon will disappear.

User settings mode (if equipped)

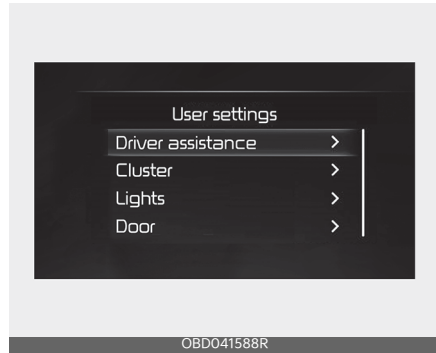

In this mode, you can change the settings of the instrument cluster, doors, lamps, etc.

The information provided may differ depending on which functions are applicable to your vehicle.

Shift to P to edit settings/Engage parking brake to edit settings

This warning message appears if you try to adjust the User Settings whilst driving.

- Automatic transmission, Dual clutch transmission, Intelligent Variable Transmission

For your safety, change the User Settings after parking the vehicle, applying the parking brake and moving the shift lever to P (Park).

- Manual Transmission

For your safety, change the User Settings after engaging the parking brake.

Driver Assistance (if equipped)

Items	Explanation
SCC Reaction (if equipped)	<ul style="list-style-type: none"> Fast/Normal/Slow To adjust the sensitivity of Smart Cruise Control. * For more details, refer to "Smart Cruise Control (SCC) (if equipped)" on page 6-117.
Haptic Warning (if equipped)	<ul style="list-style-type: none"> If this item checked, the Haptic Warning will be activated.
Warning Timing (if equipped)	<ul style="list-style-type: none"> Normal/Late To select the Warning Time.
Warning Volume (if equipped)	<ul style="list-style-type: none"> High/Medium/Low/Off To select the Warning Volume.
Driver Attention Warning (if equipped)	<ul style="list-style-type: none"> Leading vehicle departure alert/Inattentive Drive Warning To select the function. * For more details, refer to "Driver Attention Warning (DAW) (if equipped)" on page 6-107.
Forward Safety (if equipped)	<ul style="list-style-type: none"> Active Assist/Warning Only/Off To select the functions. * For more details, refer to "Forward Collision-Avoidance Assist (FCA) (Sensor fusion) (if equipped)" on page 6-69.
Lane Safety (if equipped)	<ul style="list-style-type: none"> Assist/Warning Only/Off To select the functions. * For more details, refer to "Lane Keeping Assist (LKA) (if equipped)" on page 6-81.
Blind-Spot Safety (if equipped)	<ul style="list-style-type: none"> Safe Exit Warning To select the function. * For more details, refer to "Safe Exit Warning (SEW) (if equipped)" on page 4-20. <ul style="list-style-type: none"> Active Assist/Warning Only/Off To select the function. * For more details, refer to "Blind-Spot Collision-Avoidance Assist (BCA) (if equipped)" on page 6-94.
Parking Safety (if equipped)	<ul style="list-style-type: none"> Parking Distance Warning Auto ON To select the function. * For more details, refer to "Forward/Reverse Parking Distance Warning (PDW) (if equipped)" on page 4-96. <ul style="list-style-type: none"> Rear Cross-Traffic Safety To select the function. * For more details, refer to "Rear Cross-Traffic Collision-Avoidance Assist (RCCA) (if equipped)" on page 6-141.

* The information provided may differ depending on which systems are applicable to your vehicle.

Cluster

Items	Explanation
Wallpaper (if equipped)	<ul style="list-style-type: none"> Wallpaper A/Wallpaper B/Wallpaper C To select the theme of instrument cluster LCD.
Fuel Econ. Reset	<ul style="list-style-type: none"> If this item checked, the average fuel economy will reset automatically after refuelling or after ignition.
Wiper/Lights Display	<ul style="list-style-type: none"> If this item checked, the Wiper/Lights Display will be activated.
Traffic Signs (if equipped)	<ul style="list-style-type: none"> If this item checked, the Traffic Signs will be activated.
Icy Road Warning	<ul style="list-style-type: none"> If this item checked, the Icy Road Warning display will be activated.
Welcome Sound (if equipped)	<ul style="list-style-type: none"> If this item checked, the Welcome Sound will be activated.

* The information provided may differ depending on which functions are applicable to your vehicle.

Lights

Items	Explanation
One Touch Turn Signal	<ul style="list-style-type: none"> Off: The one touch turn signal function will be deactivated. 3, 5, 7 flashes: The turn signal indicator will blink 3, 5, or 7 times when the turn signal lever is moved slightly. * For more details, refer to "Lighting" on page 4-100.
Ambient Light Brightness (if equipped)	<ul style="list-style-type: none"> Off/Level 1,2,3,4 To adjust the brightness of the Ambient Light.
Ambient Light Colour (if equipped)	<ul style="list-style-type: none"> Blue Flight/Peaceful Forest/Dreamy Purple/Aurora Violet/Orange Delight/Golden Insight/Refreshing Sea To select the colour of the Ambient Light.
Ambient Lighting (if equipped)	<ul style="list-style-type: none"> To activate or deactivate the Ambient Lighting.
Headlight Delay (if equipped)	<ul style="list-style-type: none"> To activate or deactivate the headlight delay function.
High Beam Assist (if equipped)	<ul style="list-style-type: none"> To activate or deactivate High Beam Assist function. * For more details, refer to "High Beam Assist (HBA) (if equipped)" on page 4-107.

* The information provided may differ depending on which functions are applicable to your vehicle.

Door

Items	Explanation
Auto Lock	<ul style="list-style-type: none"> • Enable on shift (if equipped with Automatic transmission, Dual clutch transmission, Intelligent Variable Transmission) : All doors will be automatically locked if the vehicle is shifted from the P (Park) position to the R (Reverse), N (Neutral), or D (Drive) position. (with the engine ON, it is activated.) • Enable on speed: All doors will be automatically locked when the vehicle speed exceeds 15 km/h (9.3 mph). • Off : The auto door lock operation will be deactivated.
Auto Unlock	<ul style="list-style-type: none"> • On shift to P (if equipped with Automatic transmission, Dual clutch transmission, Intelligent Variable Transmission): All doors will be automatically unlocked if the gear is shifted to the P (Park) position. (with the engine ON, it is activated.) • Vehicle off : All doors will be automatically unlocked when the ignition switch or the ENGINE START/STOP button is set to the OFF position. • Off : The auto door unlock operation will be cancelled.
2 Press Unlock(if equipped)	If this item is checked, the two press unlock will be activated.Press the door unlock button once to unlock the driver's door, and press the button once more within 4 seconds to unlock the rest of the doors.
Remote Window(if equipped)	<ul style="list-style-type: none"> • To activate or deactivate the Remote Window. * For more details, refer to "Remote window closing/opening system (if equipped)" on page 4-35.
Smart Trunk (if equipped)	<ul style="list-style-type: none"> • To activate or deactivate the Smart Trunk. * For more details, refer to "Smart Trunk(For 4door) (if equipped)" on page 4-27.

* The information provided may differ depending on which systems are applicable to your vehicle.

Convenience (if equipped)

Items	Explanation
Seat Easy Access (if equipped)	<ul style="list-style-type: none"> • Off/Normal/Extended To select the function. * For more details, refer to "Driver position memory system (if equipped, for power seat)" on page 3-8.
Rear Occupant Alert (if equipped)	<ul style="list-style-type: none"> • To activate or deactivate Rear Occupant Alert function. * For more details, refer to "Rear Occupant Alert (ROA) system (if equipped)" on page 4-19.
Service Interval	<ul style="list-style-type: none"> • Enable Service Interval : If this item is checked, the Service Interval function will be activated. • Adjust Interval : If the Service Interval menu is activated, you may adjust the time and distance. • Reset : To reset the Service Interval function.
Welcome Mirror/Light (if equipped)	<ul style="list-style-type: none"> • To activate or deactivate the Welcome Mirror/Light function.

Items	Explanation
Wireless Charging System (if equipped)	<ul style="list-style-type: none"> To activate or deactivate the Wireless Charging System function. For more details, refer to "Wireless smart phone charging system (if equipped)" on page 4-146.

If the service interval is activated and the time and distance is adjusted, messages are displayed in the following situations each time the vehicle is turned on.

- Service in: Displayed to inform the driver the remaining mileage and days to service.
- Service required: Displayed when the mileage and days to service has been reached or passed.

If any of the following conditions occur, the mileage and number of days to service may be incorrect.

- The battery cable is disconnected.
- The battery is discharged.

Units

Items	Explanation
Speed Unit	<ul style="list-style-type: none"> km/h, MPH To select the Speedometer unit.
Temperature Unit	<ul style="list-style-type: none"> °C/°F To select the Temperature unit.
Fuel Econ. Unit	<ul style="list-style-type: none"> L/100km, km/L or US gallon, UK gallon To select the Fuel economy unit.
Tyre Pressure Unit	<ul style="list-style-type: none"> psi, kPa, bar To select the Tyre Pressure Unit.

* The information provided may differ depending on which functions are applicable to your vehicle.

Language

Items	Explanation
Language	<ul style="list-style-type: none"> To select language.

Reset

Items	Explanation
Reset	You can reset the menus in the User Settings mode.

Vehicle Settings (For Infotainment System equipped vehicle)



Vehicle Settings in the infotainment system provides user options for a variety of settings including door lock/unlock features, convenience features, driver assistance settings, etc.

Vehicle Settings menu

- Driver assistance
- Drive Mode
- Cluster
- Climate
- Seat
- Lights
- Door
- Convenience
- Default

The information provided may differ depending on which functions are applicable to your vehicle.

* For detailed information, scan the QR code in a separately supplied Car Infotainment System Quick Reference Guide.

⚠ WARNING

Do not operate the Vehicle Settings whilst driving. This may cause distraction resulting in an accident.

Warning messages (for Type B cluster)

Warning messages appear on the LCD to warn the driver. It is located in the centre of the instrument cluster.

The warning message may appear differently depending on the type of instrument cluster and some may not show the warning message at all.

The warning message is shown in either symbol, symbol and text, or text type only.

Door, bonnet, Trunk(tailgate) open



- This warning is displayed indicating which door, or the bonnet, or the Trunk(tailgate) is open.

Sunroof open (if equipped)



- This warning is displayed if you turn off the engine when the sunroof is open.

Window open (if equipped)



- This warning is displayed if you turn off the engine when any window is open.

Lights mode

Type A



Type B



- This indicator displays which exterior light is selected using the lighting control.

You can activate or deactivate Wiper/Lights Display function from the User Settings mode in the cluster LCD display or the Settings in the Infotainment System screen.

Wiper mode

Type A



Type B



- This indicator displays which wiper speed is selected using the wiper control.

You can activate or deactivate Wiper/Lights Display function from the User Settings mode in the cluster LCD display or the Settings in the Infotainment System screen.

Engine Overheated

- This warning message illuminates when the engine coolant temperature exceeds the proper range. This means that the engine is overheated and may be damaged.

* If your vehicle is overheated, refer to "If the engine overheats" on page 7-6.

Shift to P (for smart key system and Automatic transmission, Dual clutch transmission, Intelligent Variable Transmission) (if equipped)

- This warning message illuminates if you try to turn off the engine without the gear in P (Park) position.
- At this time, the ENGINE START/STOP button turns to the ACC position.

Low key battery (for smart key system) (if equipped)

- This warning message illuminates if the battery of the smart key is discharged when the ENGINE START/STOP button changes to the OFF position.

Press START button whilst turning wheel (for smart key system) (if equipped)

- This warning message illuminates if the steering wheel does not unlock normally when the ENGINE START/STOP button is pressed.
- It means that you should press the ENGINE START/STOP button whilst turning the steering wheel right and left.

Check Steering Wheel Lock System (for smart key system) (if equipped)

- This warning message illuminates if the steering wheel does not lock normally when the ENGINE START/STOP button changes to the OFF position.

Press clutch pedal to start engine (for smart key system and manual transmission) (if equipped)

- This warning message illuminates if the ENGINE START/STOP button changes to the ACC position twice by pressing the button repeatedly without depressing the clutch pedal.
- It means that you should depress the clutch pedal to start the engine.

Press brake pedal to start engine (for smart key system) (if equipped)

- This warning message illuminates if the ENGINE START/STOP button changes to the ACC position twice by pressing the button repeatedly without depressing the brake pedal.
- It means that you should depress the brake pedal to start the engine.

Key not in vehicle (for smart key system) (if equipped)

- This warning message illuminates if the smart key is not in the vehicle when you press the ENGINE START/STOP button.
- It means that you should always have the smart key with you.

Key not detected (for smart key system) (if equipped)

- This warning message illuminates if the smart key is not detected when you press the ENGINE START/STOP button.

Press START button again (for smart key system) (if equipped)

- This warning message illuminates if you can not operate the ENGINE START/STOP button when there is a problem with the ENGINE START/STOP button system.
- It means that you could start the engine by pressing the ENGINE START/STOP button once more.
- If the warning illuminates each time you press the ENGINE START/STOP button, have the vehicle inspected by a professional workshop. Kia recommends to visit an authorised Kia dealer/service partner.

Press START button with key (for smart key system) (if equipped)

- This warning message illuminates if you press the ENGINE START/STOP button whilst the warning message "Key not detected" is illuminating.
- At this time, the immobiliser indicator light blinks.

Shift to P or N to start engine (for smart key system) (if equipped)

- This warning message illuminates if you try to start the engine with the shift gear not in the P (Park) or N (Neutral) position.

*** NOTICE**

You can start the engine with the shift lever in the N (Neutral) position. But, for your safety, we recommend that you start the engine with the gear in the P (Park) position.

Check exhaust system (if equipped)

- This warning message illuminates if the PPF system has a malfunction.
- At this time, PPF warning light also blinks.
In this case, have the vehicle inspected by a professional workshop. Kia recommended to visit an authorised Kia dealer/service partner.

* PPF : Petrol Particulate Filter

Low fuel

- This warning message is displayed if the fuel tank is almost out of fuel.
- When this message is displayed, the low fuel level warning light in the cluster will come on.
- It is recommended to look for the nearest fueling station and refuel as soon as possible.

Low washer fluid (if equipped)

- This warning message is displayed if the washer fluid level in the reservoir is nearly empty.
- Have the washer fluid reservoir refilled.

Check headlight LED (if equipped)

- This message is displayed if there is a problem with the LED headlamp. In this case, have the vehicle inspected by a professional workshop. Kia recommended to visit an authorised Kia dealer/service partner.

Device in wireless charger (if equipped)

- This warning messages will illuminate when the vehicle ignition is in OFF and the smart phone is on the wireless charging pad in below two situations.

1. When the driver or passenger door is opened.
2. When one minute passed after the ignition has been turned OFF (and the door has not been opened for more than one minute).

* For more details, refer to "Wireless smart phone charging system (if equipped)" on page 4-146.

Battery discharging due to external electrical devices

- The vehicle can detect self-discharge of the battery due to over-current that is generated by unauthorised electrical devices such as dashboard camera (dash cam) mounting during parking.
- If the warning continues even after external electrical devices are removed, have your vehicle inspected by a professional workshop. Kia recommends to contact an authorised Kia dealer/service partner.

* NOTICE

When there is a malfunction with the Electronic Stability Control (ESC), the Electronic Control Suspension (ECS) warning message may illuminate as well as the Electronic Stability Control (ESC) indicator light.

Trip Computer (if equipped)

Trip information (Trip computer) (For Type A cluster)

The trip computer is a microcomputer-controlled driver information system that displays information related to driving.

* NOTICE

Some driving information stored in the trip computer (for example Average Vehicle Speed) resets if the battery is disconnected.

Trip Modes

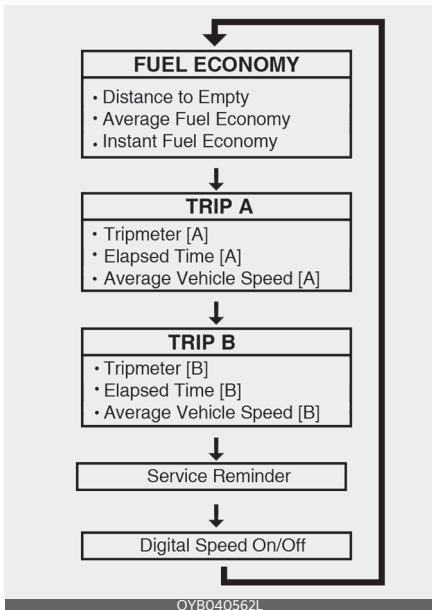

To change the trip mode, press the TRIP button.

Trip A/B



Tripmeter (1)

- The tripmeter is the total driving distance since the last tripmeter reset.
 - Distance range : 0.0 ~ 9999.9 km or mi.
- To reset the tripmeter, press the RESET button on the steering wheel for more than 1 second when the tripmeter is displayed.

Elapsed Time (2)

- The elapsed time is the total driving time since the last elapsed time reset.
 - Time range (hh:mm) : 00:00 ~ 99:59
- To reset the elapsed time, press the RESET button on the steering wheel for more than 1 second when the elapsed time is displayed.

* NOTICE

Even if the vehicle is not in motion, the elapsed time keeps going whilst the engine is running.

Average Vehicle Speed (3)

- The average vehicle speed is calculated by the total driving distance and

driving time since the last average vehicle speed reset.

- Speed range : 0 ~ 999 km/h or mph
- To reset the average vehicle speed, press the RESET button on the steering wheel for more than 1 second when the average vehicle speed is displayed.

*** NOTICE**

- The average vehicle speed is not displayed if the driving distance is less than 300 meters (0.19 miles) or the driving time is less than 10 seconds since the ignition switch or the ENGINE START/STOP button is turned to ON.
- Even if the vehicle is not in motion, the average vehicle speed keeps going whilst the engine is running.

- To clear the average fuel economy manually, press the RESET button on the steering wheel for more than 1 second when the average fuel economy is displayed.

*** NOTICE**

The average fuel economy is not displayed for more accurate calculation if the vehicle does not drive more than 10 seconds or 300 meters (0.19 miles) since the ignition switch or ENGINE START/STOP button is turned to ON.

Fuel Economy

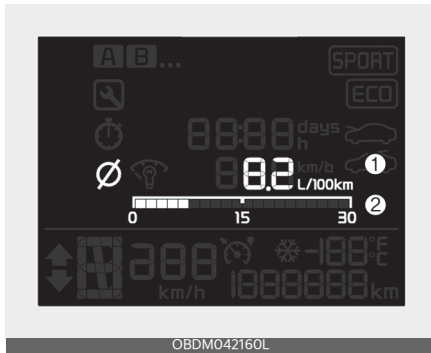

Average Fuel Economy (1)

- The average fuel economy is calculated by the total driving distance and fuel consumption since the last average fuel economy reset.
 - Fuel economy range: 0 ~ 99.9 L/100km, km/L or MPG

Instant Fuel Economy (2)

- This mode displays the instant fuel economy during the last few seconds when the vehicle speed is more than 8 km/h (5 MPH).
 - Fuel economy range: 0.0 ~ 30 L/100km, km/L or 0.0 ~ 50.0 MPG

To change the Fuel Economy unit (km/L ↔ L/100km)

Press the TRIP button for 5 seconds, the Fuel Economy unit is blink. And then press the RESET button, the Fuel Economy unit is changed. Press the TRIP button for more than one second.

Service Reminder (if equipped)

If the remaining mileage or time reaches 1,500 km (900 miles) or 30 days, the service symbol (🔧) will blink for several seconds each time you set the ignition switch or ENGINE STRAT/STOP button to the ON position.

If you exceed the specified service interval, the service symbol (🔧) will blink each time you turn ON the vehicle.

If the service interval is not set, the service symbol (🔧) will not be displayed.

* NOTICE

If it is not available to set service interval on your vehicle, have the system serviced by a professional workshop. Kia recommends to consult an authorised Kia dealer/service partner.

Digital speedometer

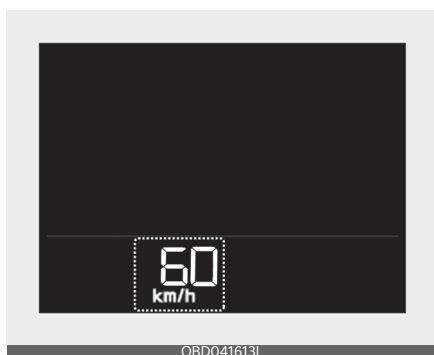

This mode displays the current speed of the vehicle.

Digital speed ON/OFF mode

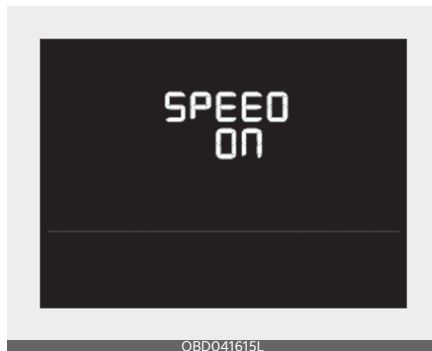
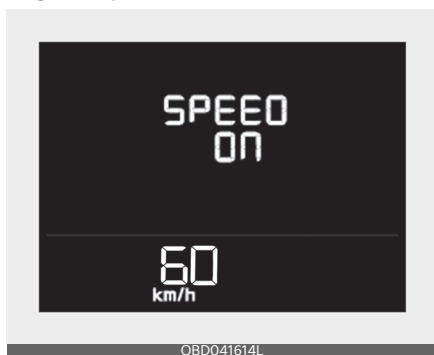

Switch to Digital speed mode using the trip switch in Trip mode, and press and hold the RESET button for more than 1 second. Then it will be switched from SPEED ON to SPEED OFF or the other way around.

Trip information (trip computer) (For Type B cluster)

The trip computer is a microcomputer-controlled driver information system that displays information related to driving.

Trip Modes

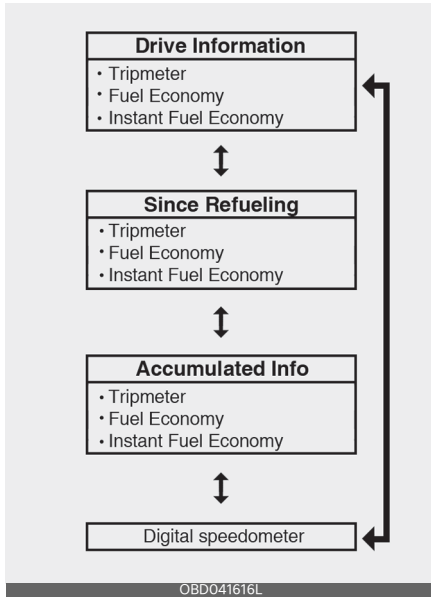

To change the trip mode, scroll the toggle the switch (∧ / ∨) on the steering wheel.

Drive Info display

This display shows the trip distance (1), the average fuel efficiency (2), and the instant fuel economy (3) information once per one ignition cycle.

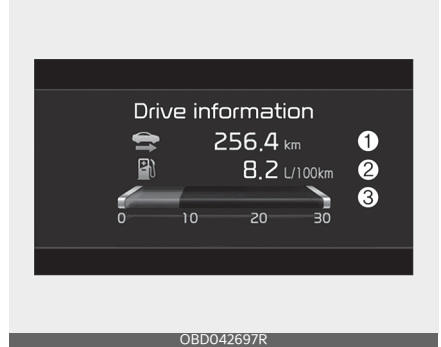
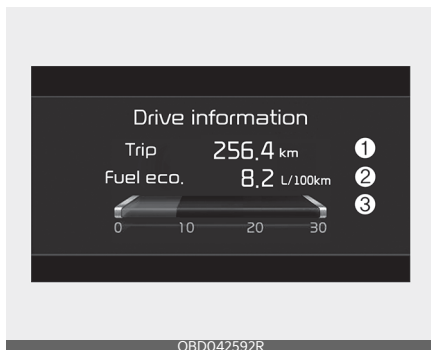

- Fuel efficiency is calculated after the vehicle has run for more than 300 meters (0.2 miles).
- The Driving Information will be reset 4 hours after ignition has been turned off. So, when the vehicle ignition is turned on within 4 hours, the information will not be reset.
- If you press "OK" button for more than 1 second after the Driving Information is displayed, the information will be reset.
- If the engine is running, even when the vehicle is not in motion, the information will be accumulated.

4

Since Refuelling

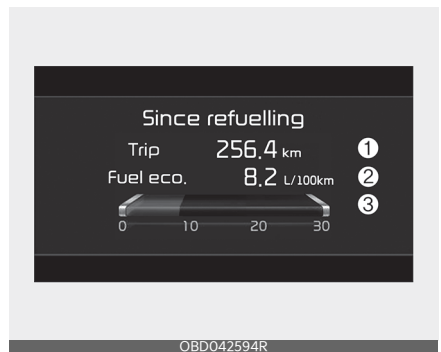

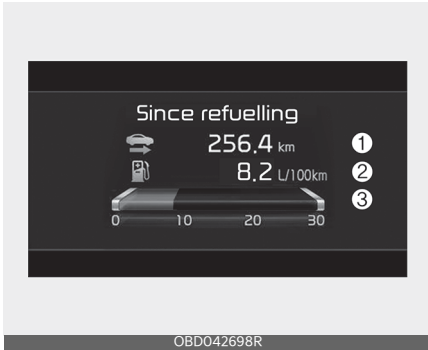

This display shows the accumulated trip distance (1), the average fuel efficiency (2), and the instant fuel economy (3) after refuelling.

- Fuel efficiency is calculated after the vehicle has run for more than 300 meters (0.2 miles).
- After refuelling more than 6 litres and driving over 1 km/h, the Since refuelling will reset to default automatically.
- If you press "OK" button for more than 1 second after the Since refuelling is displayed, the information will be reset.
- If the engine is running, even when the vehicle is not in motion, the information will be accumulated.

Accumulated driving information mode

This display shows the accumulated trip distance (1), the average fuel efficiency (2), and the instant fuel economy (3).

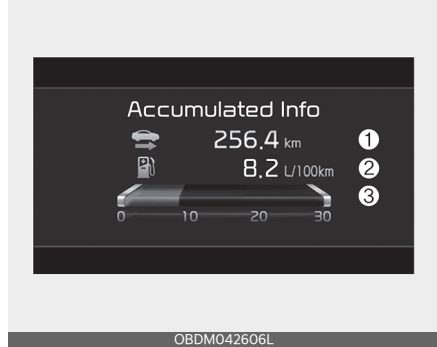
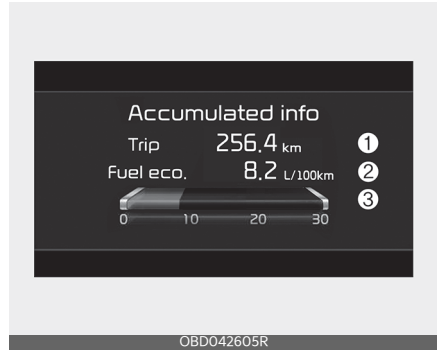

- Accumulated information is calculated after the vehicle has run for more than 300 meters (0.2 miles).
- If you press "OK" button for more than 1 second after the Cumulative Information is displayed, the information will be reset.
- If the engine is running, even when the vehicle is not in motion, the information will be accumulated.

Digital speedometer

This digital speedometer display shows the speed of the vehicle.



Warning and indicator lights

The warning light and indicator light indicate a situation where the driver should be careful and whether the various functions are activated.

Warning lights

The warning light indicates situations that require the driver to pay attention.

* NOTICE

Warning lights

Make sure that all warning lights are OFF after starting the engine. If any light is still ON, this indicates a situation that needs attention.

4

Air bag warning light (if equipped)

This warning light illuminates:

- Once you set the ignition switch or the ENGINE START/STOP button to the ON position.
 - It illuminates for approximately 6 seconds and then goes off.
- When there is a malfunction with the SRS.

In this case, have the vehicle inspected by a professional workshop. Kia recommends to visit an authorised Kia dealer/service partner.

Seat belt warning light

This warning light informs the driver that the seat belt is not fastened.

* For more details, refer to "Seat belts" on page 3-16.

Parking brake & brake fluid warning light

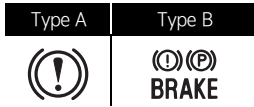

This warning light illuminates:

- Once you set the ignition switch orENGINE START/STOP button to the ON position.
 - It illuminates for approximately 3 seconds
 - It remains on if the parking brake is applied.
- When the parking brake is applied.
- When the brake fluid level in the reservoir is low.
 - If the warning light illuminates with the parking brake released, it indicates the brake fluid level in reservoir is low.

If the brake fluid level in the reservoir is low:

1. Drive carefully to the nearest safe location and stop your vehicle.
2. With the engine stopped, check the brake fluid level immediately and add fluid as required (For more details, refer to "Brake/clutch fluid (if equipped)" on page 8-45). Then check all brake components for fluid leaks. If any leak on the brake system is still found, the warning light remains on, or the brakes do not operate properly, do not drive the vehicle.

In this case, have the vehicle towed to a professional workshop and inspected. Kia recommends to visit an authorised Kia dealer/service partner.

Dual-diagonal braking system

Your vehicle is equipped with dual-diagonal braking systems. This means you still have braking on two wheels even if one of the dual systems should fail.

With only one of the dual systems working, more than normal pedal travel and greater pedal pressure are required to stop the vehicle.

Also, the vehicle will not stop in as short a distance with only a portion of the brake system working.

If the brakes fail whilst you are driving, shift to a lower gear for additional engine braking and stop the vehicle as soon as it is safe to do so.

WARNING

Parking Brake & Brake Fluid Warning Light

Driving the vehicle with a warning light ON is dangerous. If the Parking Brake & Brake Fluid Warning Light illuminates with the parking brake released, it indicates that the brake fluid level is low.

In this case, have the vehicle inspected by a professional workshop. Kia recommends to visit an authorised Kia dealer/service partner.

Anti-lock brake system (ABS) warning light

This warning light illuminates:

- Once you set the ignition switch orENGINE START/STOP button to the ON position.
 - It illuminates for approximately 3 seconds and then goes off.
- When there is a malfunction with the ABS (The normal braking system will

still be operational without the assistance of the anti-lock brake system). In this case, have the vehicle inspected by a professional workshop. Kia recommends to visit an authorised Kia dealer/service partner.

Electronic Brake Force Distribution (EBD) System Warning Light

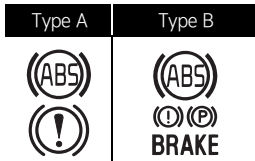

These two warning lights illuminate at the same time whilst driving:

- When the ABS and regular brake system may not work normally.

In this case, have the vehicle inspected by a professional workshop. Kia recommends to visit an authorised Kia dealer/servicepartner

WARNING

Electronic Brake Force Distribution (EBD) System Warning Light

When both ABS and Parking Brake & Brake Fluid Warning Lights are on, the brake system will not work normally and you may experience an unexpected and dangerous situation during sudden braking.

In this case, avoid high speed driving and abrupt braking.

Have the vehicle inspected by a professional workshop as soon as possible. Kia recommends to visit an authorised Kia dealer/service partner.

* NOTICE

Electronic Brake Force Distribution (EBD) System Warning Light

When the ABS Warning Light is on or both ABS and Parking Brake & Brake Fluid Warning Lights are on, the speedometer, odometer, or tripmeter may not work. Also, the MDPS Warning Light may illuminate and the steering effort may increase or decrease.

In this case, have the vehicle inspected by a professional workshop as soon as possible. Kia recommends to visit an authorised Kia dealer/service partner.

Electronic Parking Brake (EPB) warning light (if equipped)

This warning light illuminates:

- Once you set the ignition switch or ENGINE START/STOP button to the ON position.
 - It illuminates for approximately 3 seconds and then goes off.
- When there is a malfunction with the EPB.

In this case, have the vehicle inspected by a professional workshop. Kia recommends to visit an authorised Kia dealer/servicepartner

* NOTICE

Electronic Parking Brake (EPB) Warning Light

The Electronic Parking Brake (EPB) Warning Light may illuminate when the Electronic Stability Control (ESC) Indicator Light comes on to indicate that the ESC is not working properly (This does not indicate malfunction of the EPB).

Motor Driven Power Steering (MDPS) warning light

This warning light illuminates:

- Once you set the ignition switch or ENGINE START/STOP button to the ON position.
 - This indicator light comes on after the ignition key is turned to the ON position and then goes out after approximately 3 seconds.
- When there is a malfunction with the MDPS.

In this case, have the vehicle inspected by a professional workshop. Kia recommends to visit an authorised Kia dealer/service partner.

Charging System Warning Light



This warning light illuminates:

- When there is a malfunction with either the alternator or electrical charging system.

If there is a malfunction with either the alternator or electrical charging system:

1. Drive carefully to the nearest safe location and stop your vehicle.
2. Turn the engine off and check the alternator drive belt for looseness or breakage.

In this case, have the vehicle inspected by a professional workshop. Kia recommends to visit an authorised Kia dealer/service partner.

Malfunction Indicator Lamp (MIL)



This warning light illuminates:

- When you set the ignition switch or the ENGINE START/STOP button to the ON position.
 - The malfunction indicator light illuminates for about 3 seconds and then goes off.
- Whenever there is a malfunction with either the emission control system or the engine or the vehicle powertrain. If this occurs, we recommend that you have the vehicle inspected by an authorised Kia dealer/service partner.

* NOTICE

Driving with the Malfunction Indicator Lamp (MIL) on may cause damage to the emission control system which could affect drivability and/or fuel economy.

⚠ CAUTION

If the Malfunction Indicator Lamp (MIL) illuminates, potential catalytic converter damage is possible which could result in loss of engine power. In this case, we recommend that you have the vehicle inspected by an authorised Kia dealer/service partner as soon as possible.

Engine Oil Pressure Warning Light

This warning light illuminates:

- When the engine oil pressure is low.
 - Drive carefully to the nearest safe location and stop your vehicle.

- Turn the engine off and check the engine oil level (For more details, refer to "Engine oil (Petrol)" on page 8-38). If the level is low, add oil as required.
- If the warning light remains on after adding oil or if oil is not available, have the vehicle inspected by a professional workshop as soon as possible. Kia recommends to visit an authorised Kia dealer/service partner.

Continued driving with the warning light on may cause engine failure.

*** NOTICE**

When engine oil pressure decreases due to insufficient engine oil, etc., the engine oil pressure warning light will illuminate.

Overspeed warning light ¹²⁰km/h (if equipped)

This warning light blinks:

- When you drive the vehicle more than 120 km/h.
 - This is to prevent you from driving your vehicle with overspeed.
 - The overspeed warning chime also sound for approximately 5 seconds.

Low Fuel Level Warning Light 

This warning light illuminates:

When the fuel tank is nearly empty.

If the fuel tank is nearly empty:

Add fuel as soon as possible.

⚠ CAUTION

Low Fuel Level

Driving with the Low Fuel Level warning light on or with the fuel level below "O or E" can cause the engine to misfire.

Master warning light 

This indicator light illuminates:

- This warning light informs the driver the following situations
 - LED headlamp malfunction (if equipped)
 - Lamp malfunction
 - High Beam Assist malfunction (if equipped)

To identify the details of the warning look at the LCD display.

If the warning situation is solved, the master warning light will turn off.

Exhaust System (PPF) Warning Light (Petrol Engine)  (if equipped)

This warning light illuminates:

- When there is a malfunction with Petrol Particulate Filter (PPF) system.
- When this warning light illuminates, it may turn off after driving the vehicle:
 - The vehicle should be driven for more than 30 minutes at a speed of 80 km/h (50 mph) and faster.
 - Ensure the following conditions are all met: safe road conditions, transmission 3rd gear or above, and engine speed of 1,500 - 4,000 rpm.

If this warning light blinks in spite of the procedure (at this time the LCD warning message will be displayed), have the PPF system checked by a professional workshop. Kia recommends to visit an authorised Kia dealer/service partner.

CAUTION

Petrol Engine with PPF (if equipped)

If you continue to drive with the PPF warning light blinking for a long time, the PPF system can be damaged and fuel consumption can worsen.

Low Tyre Pressure Warning Light

 (if equipped)

This warning light illuminates:

- Once you set the ignition switch or ENGINE START/STOP button to the ON position.
 - It illuminates for approximately 3 seconds and then goes off.
- When one or more of your tyres are significantly under inflated. (The location of the underinflated tyres are displayed on the LCD display (if equipped)).

* For more details, refer to "Tyre Pressure Monitoring System (TPMS) (if equipped)" on page 7-7.

This warning light remains on after blinking for approximately 70 seconds or repeats blinking on and off at the intervals of approximately 3 seconds:

- When there is a malfunction with the TPMS.

In this case, have the vehicle inspected by a professional workshop.

Kia recommends to visit an authorised Kia dealer/service partner.

* For more details, refer to "Tyre Pressure Monitoring System (TPMS) (if equipped)" on page 7-7.

WARNING

Low tyre pressure

- Significantly low tyre pressure makes the vehicle unstable and can contribute to loss of vehicle control and increased braking distances.
- Continued driving or low pressure tyres will cause the tyres to overheat and fail.

WARNING

Safe Stopping

- The TPMS cannot alert you to severe and sudden tyre damage caused by external factors.
- If you notice any vehicle instability, immediately take your foot off the accelerator pedal, apply the brakes gradually with light force, and slowly move to a safe position off the road.

LED Headlamp Warning Light

 (if equipped)

This warning light illuminates:

- When there is a malfunction with the LED headlamp.

In this case, have the vehicle inspected by a professional workshop. Kia recommends to visit an authorised Kia dealer/service partner.

⚠ CAUTION**LED Headlamp Warning Light**

Continuous driving with the LED Headlamp Warning Light on can reduce LED headlamp (low beam) life.

Forward Safety Warning light

 (if equipped)

This indicator light illuminates:

- When there is a malfunction with Forward Collision-Avoidance Assist.

In this case, have the vehicle inspected by a professional workshop. Kia recommends to visit an authorised Kia dealer/service partner.

Door Ajar Warning Light  (if equipped)**This warning light illuminates:**

When a door is not closed securely.

Trunk/tailgate Open Warning Light  (if equipped)**This warning light illuminates:**

When the trunk is not closed securely.

Washer Fluid Warning Light  (if equipped)**This warning light illuminates:**

- When the washer fluid level in the reservoir is nearly empty.
In this case, you should refill the washer fluid.

Bonnet open warning light  (if equipped)**This warning light blinks:**

- When the bonnet warning light will appear on the LCD display when the bonnet is open.
The warning chime will operate when the vehicle is being driven at or above 3 km/h (2 mph) with the bonnet open.

Icy Road Warning Light  (if equipped)

- This warning light is to warn the driver the road may be icy.

When the temperature on the outside temperature gauge is approximately below 4°C (39°F), the Icy Road Warning Light and Outside Temperature Gauge blinks and then illuminates. Also, the warning chime sounds 1 time.

*** NOTICE**

If the icy road warning light appears whilst driving, you should drive more attentively and safely, refraining from over-speeding, rapid acceleration, sudden braking or sharp turning, etc.

AUTO HOLD Indicator Light **This indicator light illuminates:**

- [White] When you activate the auto hold system by pressing the AUTO HOLD button.
- [Green] When you stop the vehicle completely by depressing the brake pedal with the auto hold system activated.

- [Yellow] When there is a malfunction with the auto hold system.
In this case, have the vehicle inspected by a professional workshop. Kia recommends to visit an authorised Kia dealer/service partner.
- * For more details, refer to "AUTO HOLD (if equipped)" on page 6-44.

Indicator lights

Electronic stability control (ESC) indicator light (if equipped)

This indicator light illuminates:

- Once you set the ignition switch or ENGINE START/STOP button to the ON position.
 - It illuminates for approximately 3 seconds and then goes off.
- When there is a malfunction with the ESC system.
In this case, have the vehicle inspected by a professional workshop. Kia recommends to visit an authorised Kia dealer/service partner.

This indicator light blinks:

Whilst the ESC is operating.

- * For more details, refer to "Electronic Parking Brake (EPB) (if equipped)" on page 6-41.

Electronic stability control (ESC)

OFF indicator light (if equipped)

This indicator light illuminates:

- Once you set the ignition switch or ENGINE START/STOP button to the ON position.
 - It illuminates for approximately 3 seconds and then goes off.
- When you deactivate the ESC system by pressing the ESC OFF button.
- * For more details, refer to "Electronic Stability Control (ESC) (if equipped)" on page 6-49.

Immobiliser Indicator Light (Without Smart Key) (if equipped)

This indicator light illuminates:

- When the vehicle detects the immobiliser in your key properly whilst the ignition switch or is ON.
 - At this time, you can start the engine.
 - The indicator light goes off after starting the engine.

This indicator light blinks:

- When there is a malfunction with the immobiliser system.
In this case, have the vehicle inspected by a professional workshop. Kia recommends to visit an authorised Kia dealer/service partner.

Immobiliser Indicator Light (With Smart Key)

This indicator light illuminates for up to 30 seconds:

- When the vehicle detects the smart key in the vehicle properly whilst the ignition switch or is ACC or ON.
 - At this time, you can start the engine.
 - The indicator light goes off after starting the engine.

This indicator light blinks for a few seconds:

- When the smart key is not in the vehicle.
 - At this time, you can not start the engine.

This indicator light illuminates for 2 seconds and goes off:

- When the vehicle can not detect the smart key which is in the vehicle whilst the ENGINE START/STOP button is ON.

In this case, have the vehicle inspected by a professional workshop. Kia recommends to visit an authorised Kia dealer/service partner.

This indicator light blinks:

- When the battery of the smart key is weak.
 - At this time, you can not start the engine. However, you can start the engine if you press the ENGINE START/STOP button with the smart key. (For more details, refer to "Immobiliser system" on page 4-14).
- When there is a malfunction with the immobiliser system.

In this case, have the vehicle inspected by a professional workshop. Kia recommends to visit an authorised Kia dealer/service partner.

Turn signal indicator light

This indicator light blinks:

- When you turn the turn signal light on. If any of the following occurs, there may a malfunction with the turn signal system. In this case, have the vehicle inspected by a professional workshop. Kia recommends to visit an authorised Kia dealer/service partner.
 - The indicator light does not blink but illuminates.
 - The indicator light blinks more rapidly.
 - The indicator light does not illuminate at all.

Low beam indicator light (if equipped)

This indicator light illuminates:

- When the headlights are on.

High beam indicator light

This indicator light illuminates:

- When the headlights are on and in the high beam position.
- When the turn signal lever is pulled into the Flash-to-Pass position.

High Beam Assist indicator  (if equipped)

This warning light illuminates :

- When the high beam is on with the light switch in the AUTO light position.
- If your vehicle detects oncoming or preceding vehicles, High Beam Assist will switch the high beam to low beam automatically.

* For more details, refer to "High Beam Assist (HBA) (if equipped)" on page 4-107.

Lane Safety indicator  (if equipped)

The Lane Safety indicator will illuminate when you turn Lane Keeping Assist on by pressing Lane Safety button.

If there is a problem with the function, the yellow Lane Safety indicator will illuminate.

* For more details, refer to "Lane Keeping Assist (LKA) (if equipped)" on page 6-81.

Light ON indicator light 

This indicator light illuminates:

- When the tail lights or headlights are on.

Front fog indicator light  (if equipped)

This indicator light illuminates:

- When the front fog lights are on.

Rear Fog Indicator Light  (if equipped)

This indicator light illuminates:

- When the rear fog lights are on.

KEY OUT Indicator Light  (if equipped)

When the ENGINE START/STOP button is in the ACC or ON position, if any door is open, the system checks for the smart key.

This indicator light blinks:

When the smart key is not in the vehicle and any door is open with the ignition switch or ENGINE START/STOP button in the ACC or ON position.

- At this time, if you close all doors, the chime will also sound for approximately 5 seconds.
- The indicator will go off whilst the vehicle is moving.

Cruise indicator light  (if equipped)

This indicator light illuminates:

- When the cruise control system is enabled.

* For more details, refer to "Cruise Control (CC) (if equipped)" on page 6-114.

SPORT Mode Indicator Light  (if equipped)

This indicator light illuminates :

- When you select "SPORT" mode as drive mode.

For more details, refer to "Drive mode integrated control system" on page 6-54.

ECO Mode Indicator Light

ECO (if equipped)

This indicator light illuminates :

- When you select "ECO" mode as drive mode.

For more details, refer to "Drive mode integrated control system" on page 6-54.

Rear View Monitor (RVM) (if equipped)

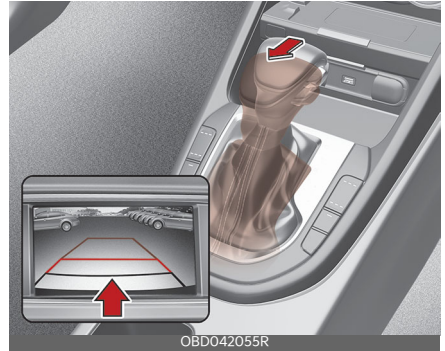

Rear View Monitor will show the area behind the vehicle to assist you when parking or backing up.

4

Detecting Sensor

Type A

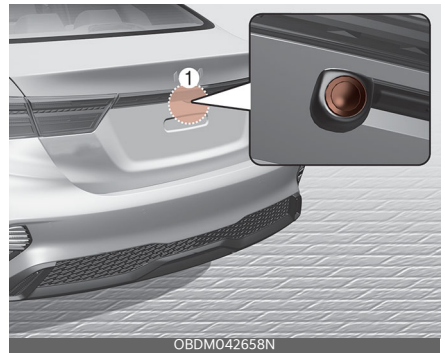

Type B

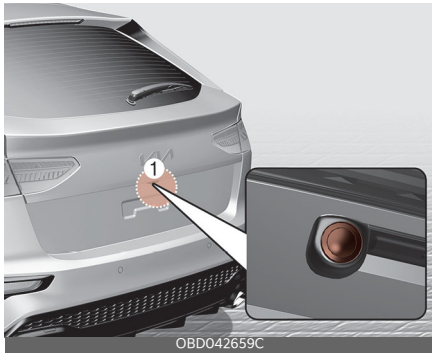

[1] : Wide-rear view camera

Refer to the picture above for the detailed location of the detecting sensor. If your vehicle is equipped with additional Infotainment System, please scan the QR code in a separately supplied Car Infotainment System Quick Reference Guide.

Rear View Monitor settings

Camera Setting



- You can change Rear View Monitor settings by pressing the setup icon (⚙️) on the screen whilst the function is operating, or select 'Setup → Vehicle (Infotainment System screen) → Parking safety → Camera settings'

from the Settings menu in the Settings in the Infotainment System screen whilst the ENGINE START/ STOP button is in the ON position.

- Display Contents: To change the settings of Rear Parking Guide Lines.
- Display Settings: To change the screen's brightness and contrast.
 - Extended rear view is activated or deactivated when you select 'Setup → Display → Extend Rear View Monitor' from the Infotainment System screen.

⚠️ WARNING

The image shown on the screen may differ from the actual distance of the object. Make sure to directly check the vehicle's surroundings for safety.

Rear View Monitor operation

Parking/View button (if equipped)

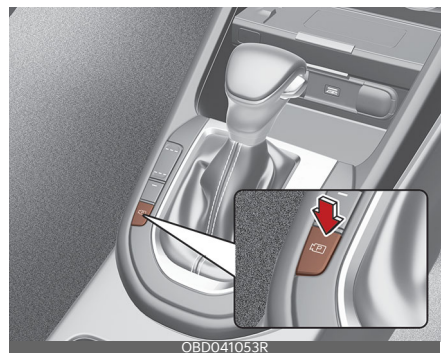

- Press the Parking/View button to turn Rear View Monitor on or off.

Rear view

Operating conditions

- If the gear is shifted to R (Reverse), whilst rear view is displayed on the screen.

Off conditions

- The rear view will not be turned off with the gear R (Reverse).
- If the gear is shifted from R (Reverse) to P (Park), the rear view will be turned off.
- The rear view will turn off when the Parking/View button is pressed. (if equipped)

Rear view whilst driving (if equipped)



Rear view whilst driving is a driving assist function that shows the image behind the vehicle on the screen regardless of vehicle speed whilst driving.

Operating conditions

- The ENGINE START/STOP button is ON.
- The Parking/view button is pressed when gearshift status is D (Drive), N (Neutral). (if equipped)

Off conditions

- Driving view button is pressed again.
- One of the infotainment system button is pressed.
- If the gear is shifted to P (park), the function is turned off.

When operating

- If the gear is shifted to R (Reverse), whilst Rear view whilst driving is displayed on the screen, the screen will change to rear view

Rear top view (if equipped)



When you touch the Soft button (), the top view is displayed on the screen and shows the distance from the vehicle in the back of your vehicle whilst parking.

Extended Rear View Monitor

If the gear is shifted from R (Reverse) to N (Neutral) or D (Drive), the rear view will be maintained to park the vehicle safely.

Operating conditions

- If the gear is shifted from R (Reverse) to N (Neutral) or D (Drive), the rear view will be turned on.

Off conditions

- The rear view will turn off when vehicle speed is above 10 km/h.
- If the gear is shifted to P (Park), the function is turned off.

Rear View Monitor malfunction and limitations

Rear View Monitor malfunction

- When Rear View Monitor is not working properly, or the screen flickers, or the camera image does not display normally, We recommend that you have your vehicle inspected by an authorised Kia dealer/service partner.

Limitations of Rear View Monitor

- When the vehicle is stopped for a long time in winter or when the vehicle is parked in an indoor parking lot, the exhaust fumes may temporarily blur the image.

WARNING

- Rear View Monitor is not a safety device. It only serves to assist the driver in identifying objects directly behind the middle of the vehicle. The camera does not cover the complete area behind the vehicle.
- Never rely solely on the rear view monitor. As there are blind spots that do not appear on the camera whilst backing up and parking, You must always use methods of viewing the area behind you including looking over both shoulders as well as continuously checking all three rear view mirrors.
- Always look around your vehicle to make sure there are no objects or obstacles before moving the vehicle in any direction to prevent a collision.

- Always pay close attention when the vehicle is driven close to objects, particularly pedestrians, and especially children.
 - If the camera lens is covered with foreign material, the Rear View Monitor may not operate normally. Always keep the camera lens clean. However, do not use chemical solvents such as strong detergents containing high alkaline or volatile organic solvents (petrol, acetone etc.). This may damage the camera lens.
-

Reverse Parking Distance Warning (PDW) (if equipped)

Reverse Parking Distance Warning will warn the driver if an obstacle is detected when the vehicle is backing up at low speeds.

Detecting sensor

Type A

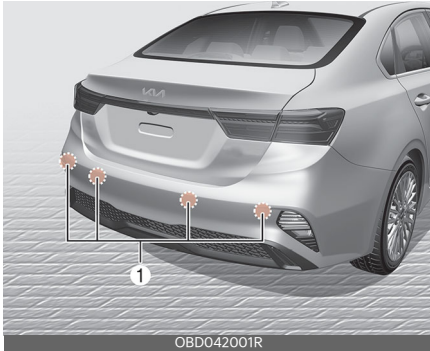

Type B



[1] : Rear ultrasonic sensors

Refer to the picture above for the detailed location of the detecting sensors.

⚠ WARNING

- Reverse Parking Distance Warning may not operate normally when:
 - Moisture is frozen on the sensor
 - Sensor is covered with foreign matters, such as snow or water
 - Outside air temperature is extremely hot or cold.
 - Sensor components are arbitrarily removed.
 - The sensor is pushed, scratched or stuck with any hard and sharp objects that could damage the surface.
 - High pressure water is directly applied to ultrasonic sensor.
- Reverse Parking Distance Warning may malfunction when:
 - Driving on uneven road, gravel roads or bushes
 - Objects that generates ultrasonic waves such as vehicle horns, loud motorcycle engine sound or truck air brakes are near the sensor
 - Heavy rain or water spray is present
 - Wireless transmitters or mobile phones are present near the sensor
 - The sensor is covered with snow
 - Affected by another vehicle's sensors
 - Water flows on the surface of the sensor
 - Installing the license plate differently from the original location
 - The vehicle bumper height or sensor installation has been modified.
 - Any non-factory equipment or accessories have been installed.

- The function will operate normally when such foreign matters are removed.
- The following objects may not be detected:
 - Sharp or slim objects, such as ropes, chains or small poles
 - Objects, which tend to absorb sensor frequency, such as clothes, spongy material or snow
 - Objects smaller than 100 m (40 in) in length and narrower than 14 cm (6 in) in diameter
 - People, animal or objects located very close to the sensor.
- The indicator may operate differently when the people, animal or obstacle is located between sensors.
- Parking Distance Warning may not occur sequentially depending on vehicle speed or obstacle shape.
- Have the function be checked by an authorised Kia dealer/service partner.

Reverse Parking Distance Warning settings

Warning volume

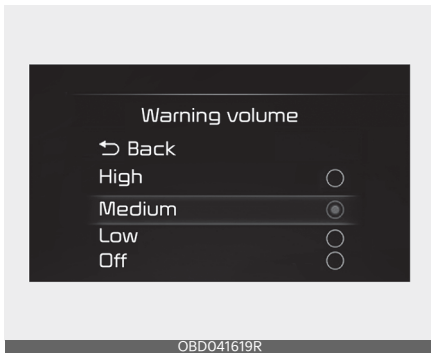

With the ignition switch or the ENGINE START/STOP button in the ON position, select 'Driver assistance → Warning volume' from the Settings menu to change the warning volume to 'High', 'Medium' or 'Low' for Reverse Parking Distance Warning.



If you change the warning volume, the warning volume of other Driver Assistance functions may change.

Reverse Parking Distance Warning operation

Operating conditions

- Reverse Parking Distance Warning activates when the gear is R (Reverse) position.
- Reverse Parking Distance Warning assists the driver during reverse movement of the vehicle by chiming if any people, animal, or object is sensed when the vehicle speed is below 10km/h (6mph).
- When an obstacle is detected, it is displayed on the cluster and infotainment function screen.
- When more than two objects are detected at the same time, the closest one will be alerted with an audible warning.

Types of warning sound and indicator

Distance from object	Warning indicator	Warning sound
60 ~120 cm (24~48 in)		Buzzer beeps intermittently
30~60 cm (12~24 in)		Buzzer beeps frequently
within 30 cm (12 in)		Buzzer beeps continuously

The shape of the indicator in the illustration may differ from the actual vehicle.

Reverse Parking Distance Warning malfunction and precautions

Reverse Parking Distance Warning malfunction

After starting the engine, a beep will sound when the gear is shifted to R (Reverse) to indicate the function is operating normally.

However, if one or more of the following occurs, first check whether the ultrasonic sensor is damaged or whether the function is in a non-operating condition. If it still does not work properly, We recommend that you have your vehicle inspected by an authorised Kia dealer/ service partner.

- The audible warning does not sound.
- The buzzer sounds intermittently.
- The 'Ultrasonic sensor error or blockage' warning message appears on the cluster.

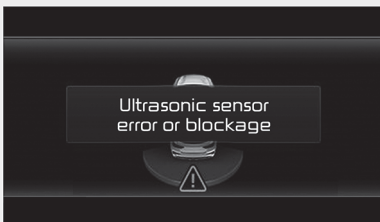

OBD041550L

WARNING

- Reverse Parking Distance Warning is a supplemental function. The operation of the function can be affected by several factors (including environmental conditions). It is the responsi-

bility of the driver to always check the rear view before and whilst parking.

- Pay close attention when driving near objects, pedestrians, and especially children.
- Some objects may not be detected by the ultrasonic sensors due to the objects distance, size or material, all of which can limit the effectiveness of the sensor.
- Your new vehicle warranty does not cover any accidents or damage to the vehicle or injuries to its occupants.

Forward/Reverse Parking Distance Warning (PDW) (if equipped)

Forward/Reverse Parking Distance Warning will warn the driver by warning indicator or sound if person, animal, or object in certain range is detected from the front/rear ultrasonic sensors (1) when the vehicle is moving forward or backward at low speeds.

Detecting sensors

Front ultrasonic sensor

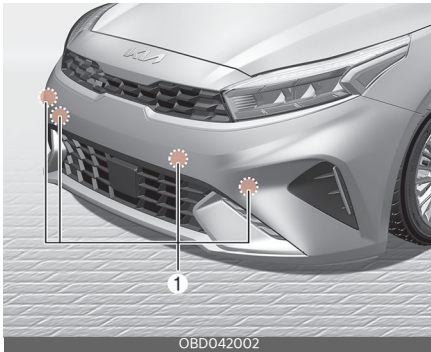

Rear ultrasonic sensor-Type A

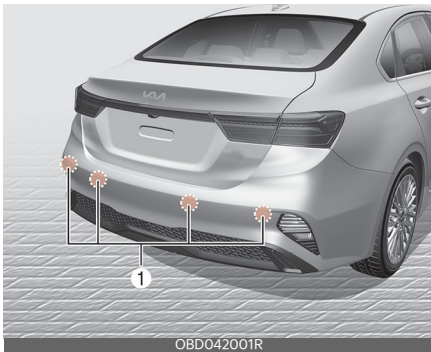

Rear ultrasonic sensor-Type B



[1] : Ultrasonic sensors

Refer to the picture above for the detailed location of the detecting sensor.

Forward/Reverse Parking Distance Warning settings

Warning volume

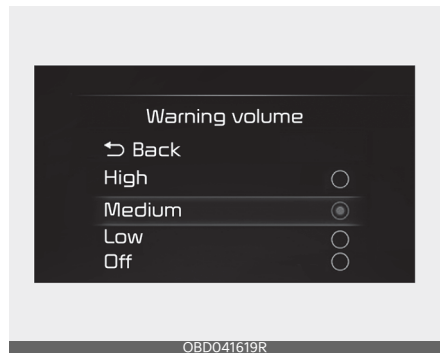

- With the ignition switch or the ENGINE START/STOP Button in the ON position, select 'Driver assistance → Warning Volume' from the Settings menu to change the warning volume to 'High', 'Medium' or 'Low' or 'Off' (if equipped) for Forward/Reverse Parking Distance Warning.

Parking Distance Warning Auto On

- Parking Distance Warning Auto On is activated or deactivated when you select 'User Settings (LCD display) or Settings → Vehicle (Infotainment System screen) → Driver assistance → Parking safety → Parking Distance Warning Auto On' from the Settings menu in the Settings menu in the cluster LCD display or the Settings in the Infotainment System screen.

For more details, refer to "LCD display modes (for Type B cluster)" on page 4-62.

If your vehicle is equipped with additional Infotainment System, please scan the QR code in a separately supplied Car Infotainment System Quick Reference Guide.

Forward/Reverse Parking Distance Warning operation

Parking Safety button

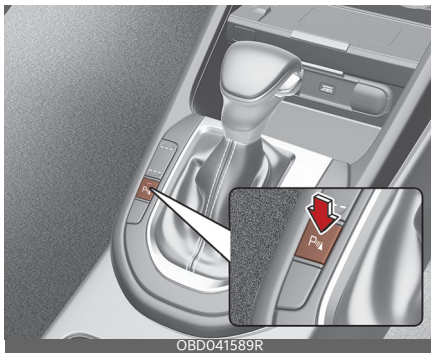

- Press Parking Safety button (P) to turn the function on and off.
- When the function is off (button indicator light off), if you shift the gear to R (Reverse), the function will automatically turn on.



- The Parking Safety (P) button indicator light will illuminate when the function operates. When the vehicle speed exceeds 30km/h (19 mph), the function will turn off and the button indicator light will not illuminate.
- When the gear is shifted to R (Reverse), even if the button is repressed, the button indicator light will not turn off and the function will operate to assist safe parking.

Forward Parking Distance Warning

- Forward Parking Distance Warning activates in following 3 conditions:
 1. The vehicle is changed from R (Reverse) to D (Drive) when Forward/Reverse Parking Distance Warning is activated
 2. The vehicle is at D (Drive) position and PDW indicator is illuminated
 3. The gear is changed at D (Drive) position whilst 'Parking Distance Warning Auto ON' is selected
- Forward/Reverse Parking Distance Warning assists the driver during movement of the vehicle by chiming if any person, animal or object is sensed if the speed of your vehicle is below 10 km/h (6 mph).
- The function will not send a warning for an obstacle if the speed of your vehicle exceeds 10 km/h(6 mph). The warning function will be activated again when the speed drops below 10 km/h(6 mph).
- If you select 'Parking Distance Warning Auto ON' on the cluster or from the menu of the infotainment system, the indicator light will be kept on.
- If vehicle speed exceeds 30 km/h (19 mph) when 'Parking Distance Warning

Features of your vehicle

Auto ON' is deselected, the indicator will turn off and if the vehicle speed is below 10 km/h (6 mph), the function will not warn you.

Distance from object	Warning indicator	
	When driving forward	Warning sound
60 ~100 cm (24~40 in)		Buzzer beeps intermittently
30~60 cm (12~24 in)		Buzzer beeps frequently
within 30 cm (12 in)		Buzzer beeps continuously



- When people, animal, or objects are detected, it is displayed on the cluster or infotainment system screen with an audible warning.
- When more than two people, animal, or objects are detected at the same time, the closest one will be warned with an audible warning.
- The shape of the indicator in the illustration may differ from the actual vehicle.

Reverse Parking Distance Warning

- Reverse Parking Distance Warning activates when the gear is R (Reverse) position.
- Reverse Parking Distance Warning assists the driver during reverse movement of the vehicle by chiming if any people, animal, or object is sensed when the vehicle speed is below 10km/h (6mph).
- The rear and front side sensors warn the driver when moving backward when the vehicle speed is below

Forward/Reverse Parking Distance Warning (PDW)

10km/h (6mph). However, the object must be within 60 cm (24 in.) from the front-side sensors to operate.

Distance from object	Warning indicator	
	When driving backward	Warning sound
60 ~120 cm (24~48 in)		Buzzer beeps intermittently
30~60 cm (12~24 in)		Buzzer beeps frequently
within 30 cm (12 in)		Buzzer beeps continuously

- When people, animal, or objects are detected, it is displayed on the cluster or infotainment system screen with an audible warning.
- When more than two people, animal, or objects are detected at the same time, the closest one will be alerted with an audible warning.
- The shape of the indicator in the illustration may differ from the actual vehicle.

Forward/Reverse Parking Distance Warning malfunction and limitations

Forward/Reverse Parking Distance Warning malfunction

After starting the engine, a beep will sound when the gear is shifted to R (Reverse) to indicate the function is operating normally.

However, if one or more of the following occurs, first check whether the ultrasonic sensor is damaged or whether the function is in a non-operating condition. If it still does not work properly, We recommend that you have your vehicle

inspected by an authorised Kia dealer/ service partner.

- The audible warning does not sound.
- The buzzer sounds intermittently.
- The 'Ultrasonic sensor error or blockage' warning message appears on the cluster.



- Always look around your vehicle to make sure there are no objects or obstacles before moving the vehicle in any direction to prevent a collision.
- Your new vehicle warranty does not cover any accidents or damage to the vehicle or injuries to its occupants related to a Reverse Parking Distance Warning.
- Always pay close attention when the vehicle is driven close to objects, particularly pedestrians, and especially children. Be aware that some objects may not be visible on the screen or be detected by the sensors, due to the objects distance, size or material, all of which can limit the effectiveness of the sensor.
- Forward/Reverse Parking Distance Warning may not operate normally when:

- Moisture is frozen to the sensor. (It will operate normally when the ice melts.)
- Sensor is covered with foreign matter, such as snow or water, or the sensor cover is blocked. (It will operate normally when the material is removed or the sensor is no longer blocked.)
- Outside air temperature is extremely hot or cold.
- Sensor components are arbitrarily removed.
- The sensor is pushed, scratched or struck with any hard and sharp objects that could damage the surface.
- High pressure water is directly applied to ultrasonic sensor.
- Heavy rain or water spray is present.
- The sensor is covered with snow.
- Affected by another vehicle's sensors.
- Water flows on the surface of the sensor.
- Driving on uneven road surfaces such as unpaved roads, gravel, bumps, or gradient.
- Objects that generates ultrasonic waves such as vehicle horns, loud motorcycle engine sound or truck air brakes are near the sensor. Water flows on the surface of the sensor.
- Installing the license plate differently from the original location.
- The vehicle bumper height or sensor installation has been modified.
- Any non-factory equipment or accessories have been installed.

- The following objects may not be recognized by the sensor:
 - Sharp or slim objects such as ropes, chains or small poles.
 - Undetectable objects smaller than 100 cm (40 in) and narrower than 14 cm (5.5 in) in diameter.
 - Objects, which tend to absorb sensor frequency such as clothes, spongy material or snow.
 - People, animal or objects located very close to the sensor
 - The indicator may operate differently when the people, animal or obstacle is located between sensors.
 - Parking Distance Warning may not occur sequentially depending on vehicle speed or obstacle shape.
 - Have the function be checked by an authorised Kia dealer/service partner.
-

Lighting

This vehicle is equipped with a variety of lights to illuminate the interior and exterior of the vehicle.

CAUTION

To prevent the battery from being discharged, do not leave the headlight and interior light on for a prolonged time whilst the engine is not running.

Battery saver function

The purpose of this feature is to prevent the battery from being discharged if the lights are left in the ON position. The system automatically shuts off the parking lights after the engine is off and the driver's door is opened. However, the position lamps stay ON even when the driver-side door is opened if the light switch is operated after the engine is turned off. If necessary, to keep the lamps on turn the position lamps OFF and ON again using the headlamp switch on the steering column after the engine is turned off.

Headlamp delay function (if equipped)

If you place the ENGINE START/STOP button in the ACC or OFF position with the headlamps ON, the headlamps (and/or position lamps) remain on for about 5 minutes. However, with the engine off if the driver's door is opened and closed, the headlamps (and/or position lamps) are turned off after 15 seconds.

The headlamps (and/or position lamps) can be turned off by pressing the lock button on the remote key or smart key twice or turning the light switch to the OFF or AUTO position. However, if you turn the light switch to the AUTO posi-

tion when it is dark outside, the headlamps will not be turned off.

You can activate or deactivate the Headlamp Delay function from the User Settings Mode in the LCD display. For more details, refer to "LCD display" on page 4-62. If your vehicle is equipped with additional navigation, please refer to the infotainment system manual separately supplied.

*** NOTICE**

If the driver exits the vehicle through another door besides the driver door, the battery saver function does not operate and the headlamp delay function does not turn OFF automatically.

This may cause the battery to discharge. To avoid battery discharge, turn OFF the headlamps manually from the headlamp switch before exiting the vehicle.

Headlamp welcome function (if equipped)

When the headlight switch is in the ON or AUTO position and all doors (and trunk) are closed and locked, if you press the door unlock button on the transmitter (or smart key), the headlights will come on for about 15 seconds. If the headlight switch is in the AUTO position, the function can only operate at night. At this time, if you press the door unlock button again or door lock button on the transmitter (or smart key), the headlights will turn off immediately.

Daytime Running Light (DRL)

The Daytime Running Light (DRL) can make it easier for others to see the front of your vehicle during the day.

The DRL can be helpful in many different driving conditions, and it is especially helpful after dawn and before sunset.

The DRL will turn the dedicated lamp OFF when:

- The headlight switch is on.
- The vehicle is off.
- The front fog light is on. (if equipped)
- Engaging the Parking Brake.

Traffic Change (For Europe)

The low beam light distribution is asymmetric. If you go abroad to a country with opposite traffic direction, this asymmetric part will dazzle oncoming car driver. To prevent dazzle, ECE regulation demand several technical solutions (ex. automatic change system, adhesive sheet, down aiming). This headlamps are designed not to dazzle opposite drivers. So, you need not change your headlamps in a country with opposite traffic direction.

Lighting control

The light switch has a headlight and a position lamp position.

Type A



OBD041553L

Type B



OBD041626R

To operate the lights, turn the knob at the end of the control lever to one of the following positions:

1. OFF position
2. Auto light position(if equipped)
3. Position & Tail lamp
4. Headlight position

Type B

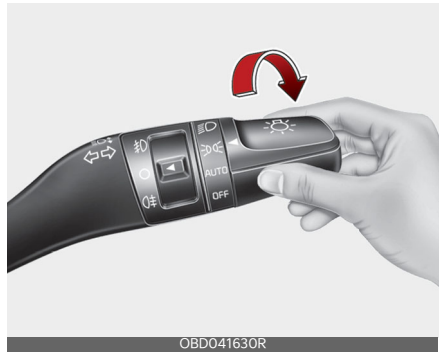

OBD041630R

When the light switch is in the position lamp position, the front position lamp and, tail, license light will turn ON.

Head light

Type A



OBD041555L

Position & Tail lamp

Type A



OBD041554L

Type B

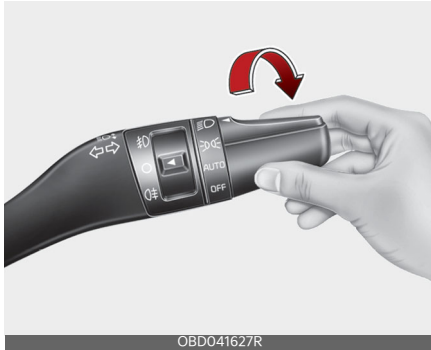

When the light switch is in the head light position, The head, tail, osition, license and instrument panel lights will turn ON.

*** NOTICE**

The ignition switch or the ENGINE START/STOP Button must be in the ON position to turn on the headlights.

Type B

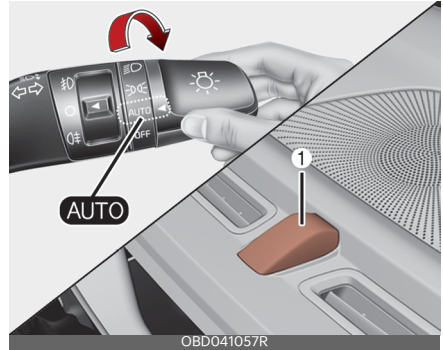

When the light switch is in the AUTO light position, the taillights and head-lights will turn ON or OFF automatically depending on the amount of light outside the vehicle.

⚠ CAUTION

- Never place anything over the sensor (1) located on the instrument panel as this will ensure better auto-light system control.
- Don't clean the sensor using a window cleaner, the cleaner may leave a light film which could interfere with sensor operation.
- If your vehicle has window tint or other types of metallic coating on the front windscreen, the Auto light system may not work properly.

Auto light (if equipped)

Type A

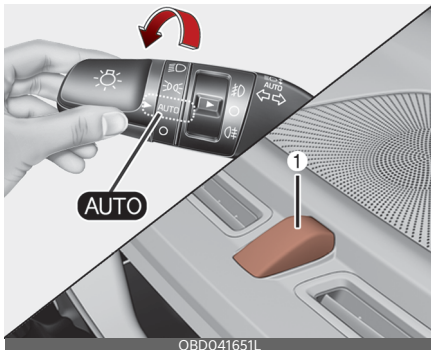

Operating high beam

Type A

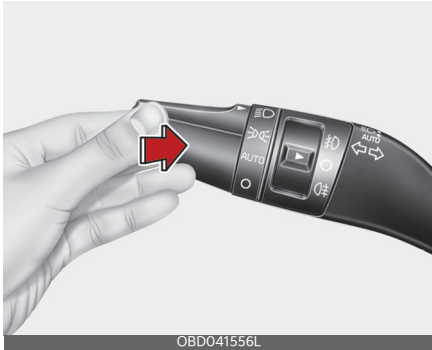

Type B

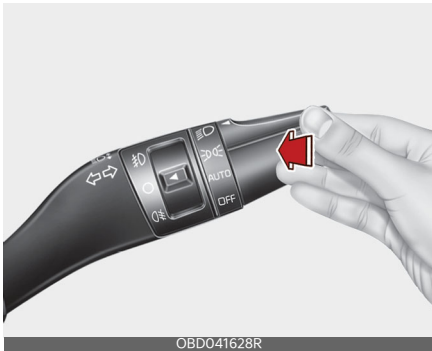

Type A

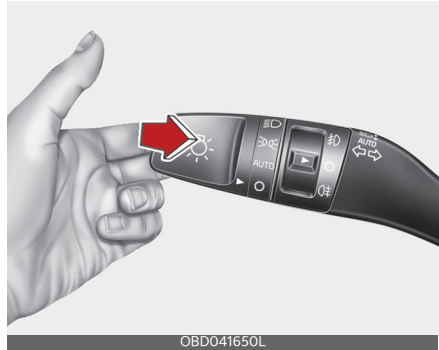

Type B



It will return to the normal (low beam) position when released. The headlight switch does not need to be on to use this flashing feature.

To turn on the high beam headlamp:

- Push the lever away from you.
The lever will return to its original position.
The high beam indicator will light when the headlight high beams are switched on.

WARNING

Do not use high beam when there are other vehicles. Using high beam could obstruct the other driver's vision.

To flash the headlights:

- Pull the lever towards you.

Operating turn signals and lane change signals

Type A

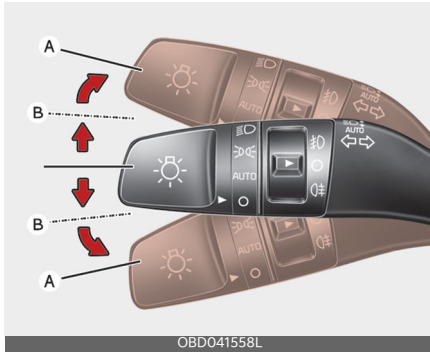

Type B

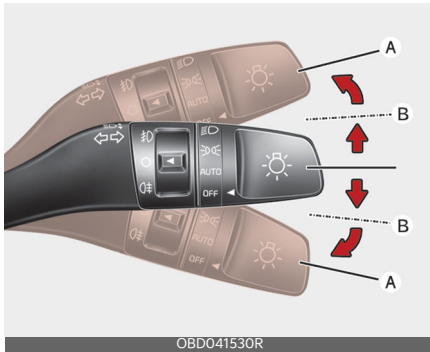

The ignition switch or the ENGINE START/STOP Button must be on for the turn signals to function.

To turn on the turn signals:

- Move the lever up or down (A).
The green arrow indicators on the instrument panel indicate which turn signal is operating.
They will self-cancel after a turn is completed. If the indicator continues to flash after a turn, manually return the lever to the OFF position.

To signal a lane change:

- Move the turn signal lever slightly and hold it in position (B).
The lever will return to the OFF position when released.

If an indicator stays on and does not flash or if it flashes abnormally, one of the turn signal bulbs may be burned out and will require replacement.

One-touch lane change function

To activate a one-touch lane change function, move the turn signal lever slightly and then release it. The lane change signals will blink 3, 5 or 7 times. You can activate or deactivate the One Touch Turn Signal function or choose the number of blinking (3, 5, or 7) by selecting "User Settings → Lights → One touch turn indicator".

* NOTICE

If an indicator flash is abnormally quick or slow, a bulb may be burned out or have a poor electrical connection in the circuit.

Operating front fog light \neq (if equipped)

Fog lights are designed to provide improved visibility when visibility is poor due to fog, rain or snow, etc.

Type A



Type B



The fog lights will turn on when the fog light switch (1) is turned to the on position after the headlight is turned on.

To turn off the fog lights:

- Turn the fog light switch (1) to the ON position.

CAUTION

When in operation, the fog lights consume large amounts of vehicle electrical power. Only use the fog lights when visibility is poor.

Operating rear fog light (if equipped)

Type A



Type B



To turn the rear fog lights on, turn the rear fog light switch (1) to the on position when the headlight is turned on.

Also, the rear fog lights turn on when the rear fog light switch is turned on after the front fog light switch (if equipped) is turned on and the headlight switch is in the parklight position.

To turn the rear fog lights off:

- Turn the rear fog light switch to the on position again.

High Beam Assist (HBA) (if equipped)

High Beam Assist is a function that automatically adjusts the headlamp range (switches between high beam and low beam) according to the brightness of other vehicles and road conditions.

Type A

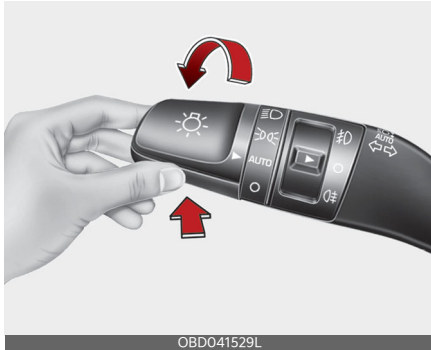

Type B

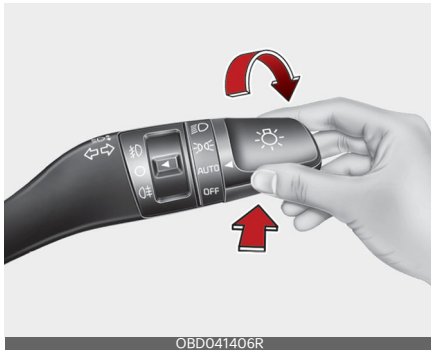



High Beam Assist settings

The driver can activate HBA by placing the ignition switch or ENGINE START/STOP button to the ON position and by selecting: 'User Settings → Lights → HBA (High Beam Assist)'.

If you disable this setting, HBA will not work.

The setting of HBA will be maintained, as selected, when the engine is re-started.

Operating condition

1. Place the light switch in the AUTO position.
2. Turn on the high beam by pushing the Light switch away from you.
3. High Beam Assist () indicator will illuminate.
4. High Beam Assist will turn on when vehicle speed is above 40 km/h (25 mph).
 - 1) If the light switch is pushed away when High Beam Assist is operating, High Beam Assist will turn off and the high beam will be on continuously.
 - 2) If the light switch is pulled towards you when the high beam is off, the high beam will turn on without High Beam Assist cancelled. When you let go of the light switch, the lever will move to the middle and the high beam will turn off.
 - 3) If the light switch is pulled towards you when the high beam is on by High Beam Assist, the low beam will be on and High Beam Assist will turn off.
 - 4) If the light switch is placed to the headlamp position (), High Beam Assist will turn off and the low beam will be on continuously.

When High Beam Assist is operating, the high beam switches to low beam in the following conditions.

- When the headlamp of an on-coming vehicle is detected.
- When the tail lamp of a vehicle in front is detected.

- When the headlamp or tail lamp of a motorcycle or a bicycle is detected.
- When the surrounding ambient light is bright enough that high beams are not required.
- When streetlights or other lights are detected.
- When the light switch is not in the AUTO position.
- When High Beam Assist is off.
- When vehicle speed is below 30 km/h (19 mph).

Warning light and message

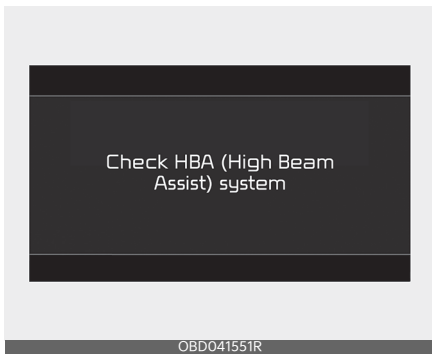

When High Beam Assist is not working properly, the warning message will come on for a few seconds. After the message disappears, the master warning light

() will illuminate.

We recommend that you take your vehicle to an authorised Kia dealer/service partner and have the function checked.

 CAUTION

The function may not operate normally if any of the following conditions should occur:

1. When the illumination from an oncoming vehicle or a vehicle in front is dim. Such examples may include:

- When the headlamps of an oncoming vehicle or the tail lamps of a vehicle in front is covered with dust, snow, or water
- When the headlamps on an oncoming vehicle are OFF, but the fog lamps are ON)

2. When High Beam Assist is adversely affected by an external condition. Such examples may include:

- When the vehicle's headlamps have been damaged or not repaired properly
- When the vehicle headlamps are not aimed properly
- When the vehicle is driven on a narrow curved road or rough road
- When the vehicle is driven on an uphill road or downhill road
- When only part of the vehicle in front is visible on a crossroad or curved road
- When there is a traffic light, reflecting sign, flashing sign or mirror
- When the road conditions are bad such as being wet or covered with snow
- When a vehicle suddenly appears from a curve
- When the vehicle is tilted from a flat tyre or being towed
- When Lane Keeping Assist warning light illuminates
- When the light from the oncoming or front vehicle is not detected because of exhaust fume, smoke, fog, snow, etc.

When the front window is covered with foreign matters such as ice, dust, fog, or is damaged

3. When the forward visibility is poor. Such examples may include:

- When the headlamps of an oncoming vehicle or a vehicle in front is not detected due to poor outside visibility (smog, smoke, dust, fog, heavy rain, snow, etc.)
- When the windscreen visibility is poor
- When the function does not operate normally, change the lamp position manually between the high beam and low beam.

WARNING

- The function may not work around 15 seconds after starting the vehicle or the initialization or rebooting of the front view camera.
- Do not attempt to disassemble the front view camera without the assistance of an authorised Kia dealer/service partner technician.
- If the front view camera is removed for any reason, the function may need to be re-calibrated. We recommend that the function be inspected by an authorised Kia dealer/service partner.
- If the windscreen of your vehicle is replaced, most likely the front view camera will need to be re-calibrated. If this occurs, have your vehicle inspected and have the function re-calibrated by an authorised Kia dealer/service partner.
- Be careful that water doesn't get into related parts of High Beam Assist and do not remove or damage related parts the function.
- Do not place objects on the crash pad that reflect light such as mirrors, white paper, etc. The function may malfunction if sunlight is reflected.
- At times, High Beam Assist may not work properly. The function is for your convenience only. It is the responsibility of the driver for safe driving practices and always check the road conditions for your safety.

Headlight levelling device



To adjust the headlight beam level according to the number of the passengers and loading weight in the luggage area, turn the beam levelling switch.

The higher the number of the switch position, the lower the headlight beam level. Always keep the headlight beam at the proper levelling position, or headlights may dazzle other road users.

Listed below are the examples of proper switch settings. For loading conditions other than those listed below, adjust the switch position so that the beam level may be the nearest as the condition obtained according to the list.

Loading condition	Switch position
Driver only	0
Driver + Front passenger	0
Full passengers (including driver)	1
Full passengers (including driver) + Maximum permissible loading	2

Loading condition	Switch position
Driver + Maximum permissible loading	3

Wipers and washers

The wipers and washers remove foreign substances from the windscreen and rear window, helping to maintain visibility.

Front - Type A

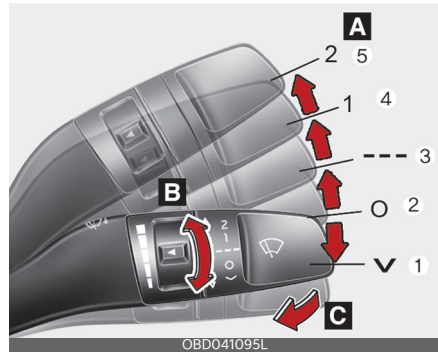

Front - Type B

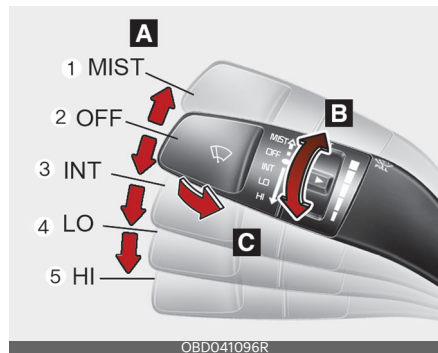

Rear 5 Door -Type A

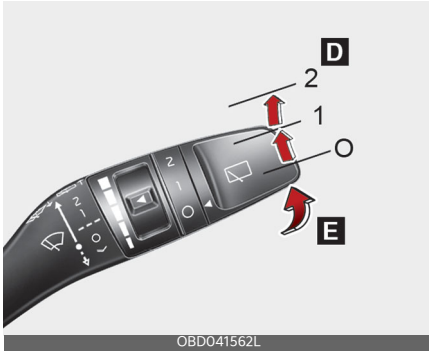

Rear 5 Door-Type B

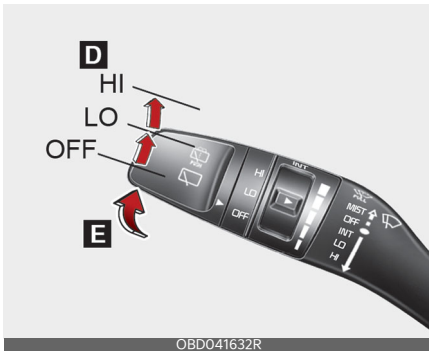

A: Wiper speed control (front)

1. MIST/V: Single wipe
2. OFF/O: Off
3. INT/---: Intermittent wipe
4. LO/1: Low wiper speed
5. HI/2: High wiper speed

B: Intermittent control wipe time adjustment/Auto control wipe time adjustment

C: Wash with brief wipes (front)

D: Rear wiper/washer control*

- 2/HI - Continuous wipe
- 1/LO - Intermittent wipe
- O/OFF - Off

E: Wash with brief wipes (rear)*

*: if equipped

*** NOTICE**

If there is heavy accumulation of snow or ice on the windscreen, defrost the windscreen for about 10 minutes, or until the snow and/or ice is removed before using the windscreen wipers to ensure proper operation. If you do not remove the snow and/or ice before using the wiper and washer, it may damage the wiper and washer system.

Operating windscreen washers (front)

Type A

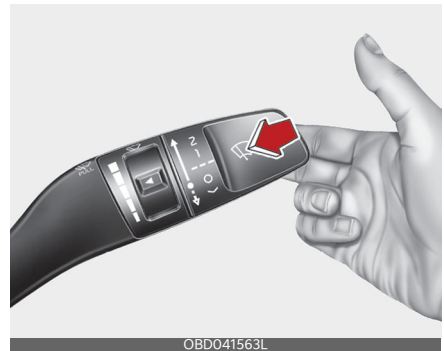

Type B

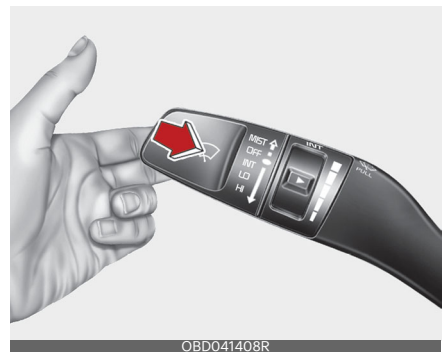

1. Move the wiper speed control switch to In OFF (O) position.
2. Pull the lever gently toward you to spray washer fluid on the windscreen and to run the wipers 1-3 cycles. Use this function when the windscreen is dirty. The spray and wiper operation will continue until you release the lever.

If the washer does not work, check the washer fluid level. If the fluid level is not sufficient, you will need to add appropriate non-abrasive windscreen washer fluid to the washer reservoir.

The reservoir filler neck is located in the front of the engine compartment on the driver side.

CAUTION

To prevent possible damage to the washer pump, do not operate the washer when the fluid reservoir is empty.

WARNING

Do not use the washer in freezing temperatures without first warming the windscreen with the defrosters; the washer solution could freeze on the windscreen and obscure your vision.

CAUTION

- To prevent possible damage to the wipers or windscreen, do not operate the wipers when the windscreen is dry.
- To prevent damage to the wiper blades, do not use petrol, kerosene, paint thinner, or other solvents on or near them.

- To prevent damage to the wiper arms and other components, do not attempt to move the wipers manually.
- To prevent possible damage to the wipers and washer system, use anti-freezing washer fluids in the winter season or cold weather.

Rear window wiper and washer switch (if equipped)

Type A

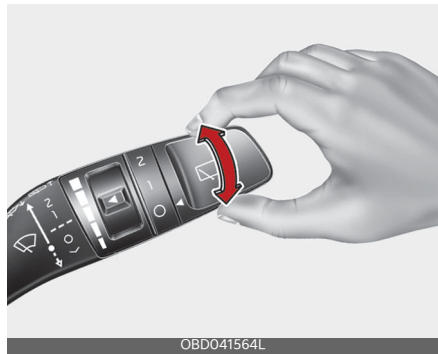

OBD041564L

Type B

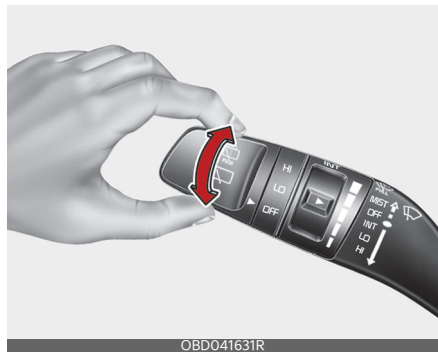

OBD041631R

The rear window wiper and washer switch is located at the end of the wiper and washer switch lever. Turn the switch to desired position to operate the rear wiper and washer.

HI / 2 - Normal wiper operation

LO / 1 - Intermittent wiper operation
 OFF / 0 - Wiper is not in operation
 Push the lever away from you to spray rear washer fluid and to run the rear wipers 1-3 cycles. The spray and wiper operation will continue until you release the lever.

Interior lights

This vehicle is equipped with lights throughout the vehicle to illuminate the interior.

⚠ CAUTION

Do not use the interior lights for extended periods when the engine is not running.

It may cause battery discharge.

⚠ WARNING

Do not use the interior lights when driving in the dark. Accidents could happen because the view may be obscured by interior lights.

4

Map lamp

Type A



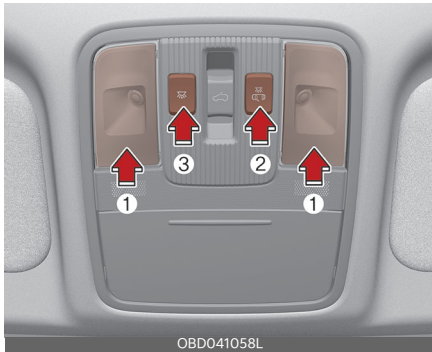

Type B



- Press the lens (1) to turn ON the map lamp.
To turn the map lamp OFF press the lens (1) again.
-  (2): DOOR mode
 - The map lamp and room lamp come on when a door is opened. The lamps go out after approximately 30 seconds.
 - The map lamp and room lamp come on for approximately 30 seconds when doors are unlocked with a smart key as long as the doors are not opened.
 - The map lamp and room lamp will stay on for approximately 10 minutes if a door is opened with the ignition switch or the ENGINE START/STOP Button in the ACC or OFF position.
 - The map lamp and room lamp will stay on continuously if the door is opened with the ignition switch or the ENGINE START/STOP Button in the ON position.
 - The map lamp and room lamp will go out immediately if the ignition switch or the ENGINE START/STOP Button is changed to the ON position or all doors are locked.

- To turn off the DOOR mode, press the DOOR button (2) once again (not pressed).

-  (3): Press this switch to turn the front map lamps on.
-  (4): Press this switch to turn the front map lamps off.

*** NOTICE**

The DOOR mode and ROOM mode can not be selected at a time.

Room lamp



-  : The light stays on at all times.

Trunk/tailgate room lamp



The trunk/tailgate room lamp comes on when the trunk (tailgate) is opened.

⚠ CAUTION

The trunk/tailgate room lamp comes on as long as the trunk (tailgate) opens. To prevent unnecessary charging system drain, close the trunk (tailgate) securely after using the trunk/tailgate room.

Vanity mirror lamp (if equipped)



- ☀ : The lamp will turn on if this button is pressed.
- ○ : The lamp will turn off if this button is pressed.

⚠ CAUTION

Vanity mirror lamp

Always have the switch in the off position when the vanity mirror lamp is not in use. If the sun visor is closed without the lamp off, it may discharge the battery or damage the sun visor.

Glove box lamp (if equipped)

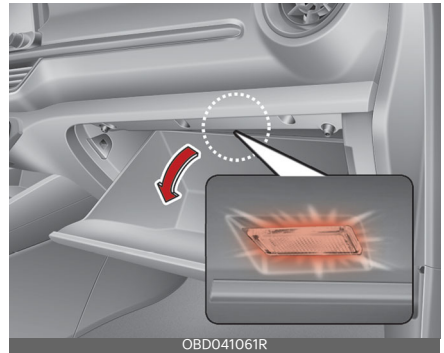

The glove box lamp comes on when the glove box is opened.

⚠ CAUTION

To prevent unnecessary charging system drain, close the glove box securely after using the glove box.

4

Climate control system



The climate control system uses cooling and heating to help maintain a pleasant environment inside the vehicle.

System operation

Ventilation

1. Set the mode to the  position.
2. Set the air intake control to the outside (fresh) air position.
3. Set the temperature control to the desired position.
4. Set the fan speed control to the desired speed.

Heating

1. Set the mode to the  position.
2. Set the air intake control to the outside (fresh) air position.
3. Set the temperature control to the desired position.
4. Set the fan speed control to the desired speed.
5. If dehumidified heating is desired, turn the air conditioning system on.
 - If the windscreen fogs up, set the mode to the  or  position.

Operation tips

- To keep dust or unpleasant fumes from entering the vehicle through the ventilation system, temporarily set the air intake control to the recirculated air position. Be sure to return the control to the fresh air position when the irritation has passed to keep fresh air in the vehicle. This will help keep the driver alert and comfortable.

- Air for the heating/cooling system is drawn in through the grilles just at the base of the windscreen. Care should be taken that these are not blocked by leaves, snow, ice or other obstructions.
- To prevent fog from forming on the inside of the windscreen:
 - Set the air intake control to the fresh air position and the fan speed to the desired position.
 - Turn on the air conditioning system, and adjust the temperature control to desired temperature.

Air conditioning (A/C)

All Kia air conditioning systems are filled with R-134a refrigerant.

1. Start the vehicle. Press the A/C button.
2. Set the mode to the  position.
3. Set the air intake control to the outside-air or recirculated air position.
4. Adjust the fan speed control and temperature control to maintain maximum comfort.

CAUTION

Excessive Air conditioning Use

When using the air conditioning system, monitor the temperature gauge closely whilst driving up hills or in heavy traffic when outside temperatures are high. Air conditioning system operation may cause vehicle overheating. Continue to use the blower fan but turn the air conditioning system off if the temperature gauge indicates vehicle overheating.

⚠ CAUTION

The air conditioning system should only be used with the windows and sunroof closed to prevent condensation inside the vehicle that may cause damage to electrical components.

Air conditioning system operation tips

- If the vehicle has been parked in direct sunlight during hot weather, open the windows for a short time to let the hot air inside the vehicle escape.
- To help reduce moisture inside of the windows on rainy or humid days, decrease the humidity inside the vehicle by operating the air conditioning system.
- During air conditioning system operation, you may occasionally notice a slight change in vehicle speed as the air conditioning compressor cycles. This is a normal characteristic of system operation.
- To ensure maximum system performance, the air conditioning system should be ran for a few minutes each month.
- When using the air conditioning system, you may notice clear water dripping (or even puddling) on the ground under the passenger side of the vehicle. This is a normal characteristic of system operation.
- Operating the air conditioning system in the recirculated air position provides maximum cooling; however, continual operation in this mode may cause the air inside the vehicle to become stale.

- During cooling operation, you may occasionally notice a misty air flow because of rapid cooling and humid air intake. This is a normal characteristic of system operation.

Climate control air filter

The climate control air filter installed behind the glove box filters the dust or other pollutants that come into the vehicle from the outside through the heating and air conditioning system.

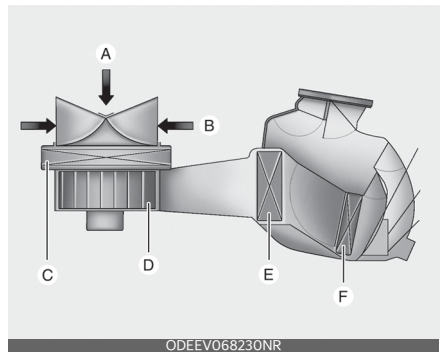

- A: Outside air
 B: Recirculated air
 C: Climate control air filter
 D: Blower
 E: Evaporator core
 F: Heater core

If dust or other pollutants accumulate in the filter over a period of time, the air flow from the air vents may decrease. This leads to moisture accumulating on the inside of the windscreen even when the outside (fresh) air position is selected. If this happens, have the climate control air filter replaced by a professional workshop. Kia recommends to visit an authorised Kia dealer/service partner.

*** NOTICE**

- Replace the filter according to the Maintenance Schedule. If the vehicle is being driven in severe conditions such as dusty or rough roads, more frequent air conditioner filter inspections and changes are required.
- When the air flow rate suddenly decreases, have the system checked by a professional workshop. Kia recommends to visit an authorised Kia dealer/service partner.

Air conditioning refrigerant label

Example - Type A



Example - Type B



* The actual air conditioning refrigerant label in the vehicle may differ from the illustration.

Each symbol and specification on the air conditioning refrigerant label is represented below:

1. Classification of refrigerant
2. Amount of refrigerant
3. Classification of Compressor lubricant
4. Caution
5. Flammable Refrigerant
6. To requires Registered Technician to service Air Conditioning system
7. Service manual



The refrigerant label is located on the underside of the bonnet.

Checking the amount of air conditioner refrigerant and compressor lubricant

When the amount of refrigerant is low, the performance of the air conditioning is reduced. Overfilling also has a negative impact on the air conditioning system.

Therefore, if abnormal operation is found, have the system inspected by a professional workshop. Kia recommends to visit an authorised Kia dealer/service partner.

⚠ WARNING

The oil and refrigerant in your vehicle's air conditioning system is under very high pressure. If proper service procedures are not followed an explosion may result. To reduce the risk of **SERIOUS INJURY OR DEATH**, the air conditioning system in your vehicle should only be serviced by trained and certified Kia technicians.

Failure to heed these warnings can lead to serious injuries.

⚠ WARNING**Vehicles equipped with R-134a**

Because the refrigerant is at very high pressure, the air conditioning system should only be serviced by trained and certified technicians. It is important that the correct type and amount of oil and refrigerant is used.

Otherwise, it may cause damage to the vehicle and personal injury.

⚠ WARNING**Vehicles equipped with R-1234yf**

Since the refrigerant is mildly flammable and operated at high pressure, the air conditioning system should only be serviced by trained and certified technicians.

It is important that the correct type and amount of oil and refrigerant are used. All refrigerants should be reclaimed with proper equipment.

Venting refrigerants directly to the atmosphere is harmful to individuals and environment.

Manual climate control system (if equipped)

The manual climate control system uses cooling and heating to help maintain a pleasant environment inside the vehicle.

Type A



Type B



1. Fan speed control knob
2. Temperature control knob
3. Air conditioning button (if equipped)
4. Rear window defroster button
5. Air intake control button
6. Mode selection knob

CAUTION

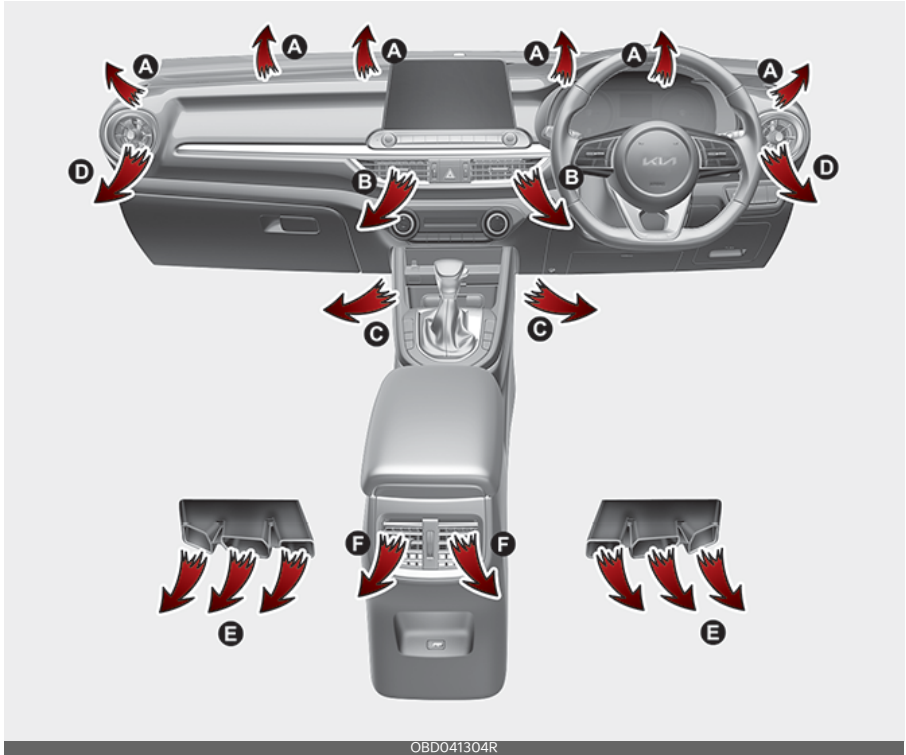

Operating the blower when the ignition switch or ENGINE START/STOP button is in the ON position could cause the battery to discharge. Operate the blower when the engine is running.

Heating and air conditioning



1. Start the engine.
2. Set the mode to the desired position.

For improving the effectiveness of heating and cooling;

 - Heating: 
 - Cooling: 
3. Set the temperature control to the desired position.
4. Set the air intake control to the outside (fresh) air position.
5. Set the fan speed control to the desired speed.

If air conditioning is desired, turn the air conditioning system on.

Mode selection

The mode selection buttons control the direction of the air flow through the ventilation system.



Air can be directed to the floor, dashboard outlets, or windscreen. Five symbols are used to represent Face, Bi-Level, Floor, Floor-Defrost and Defrost air position.

Face-Level (B, D, F)

Air flow is directed toward the upper body and face. Additionally, each outlet can be controlled to direct the air discharged from the outlet.

Bi-Level (B, C, D, E, F)

Air flow is directed towards the face and the floor.

Floor-Level (A, C, D, E, F)

Most of the air flow is directed to the floor, with a small amount of the air being directed to the windscreen, side window defrosters and side air vents.

Floor/Defrost-Level (A, C, D, E, F)

Most of the air flow is directed to the floor and the windscreen with a small amount directed to the side window defrosters and side air vents.

Defrost-Level (A, D)

Most of the air flow is directed to the windscreen with a small amount of air directed to the side window defrosters and side air vents.

Instrument panel vents

Type A



Type B

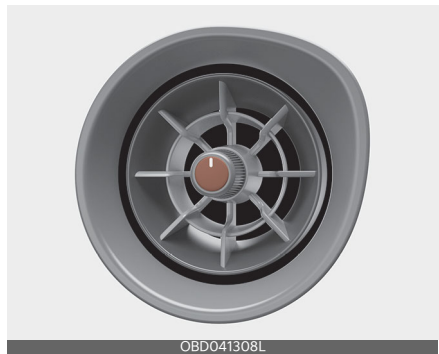



- Type A

The outlet vents can be opened or closed separately using the thumbwheel. To close the vent, rotate it downward to the maximum position. Also, you can adjust the direction of air delivery from these vents using the vent control lever as shown.

- Type B

The outlet vents can be opened or closed separately turning the knob right or left. Also, you can adjust the direction of air delivery from these vents moving the knob freely to any directions.

Temperature control

The temperature control knob allows you to control the temperature of the air flowing from the ventilation system.



To change the air temperature in the passenger compartment, turn the knob to the right for warm and hot air or to the left for cooler air.

Controlling air intake

The air intake control is used to select the outside (fresh) air position or recirculated air position.

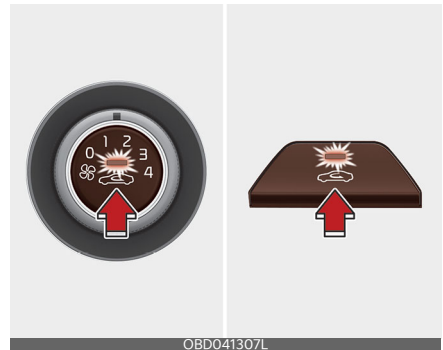

To change the air intake control position.

- Push the desired control button

Recirculated air position



The indicator light on the button illuminates when the recirculated air position is selected.

With the recirculated air position selected, air from the passenger compartment will be drawn through the heating system and heated or cooled according to the function selected.

Outside (fresh) air position



The indicator light on the but-

ton illuminates when the recirculated air position is selected.

The indicator light on the button will turn off when the outside (fresh) air position is selected.

With the outside (fresh) air position selected, air enters the vehicle from outside and is heated or cooled according to the function selected.

* NOTICE

Prolonged operation of the heater in the recirculated air position (without air conditioning selected) may cause fogging of the windscreen and side windows and make the air in the passenger compartment stale.

In addition, prolonged use of the air conditioning with the recirculated air position selected will result in excessively dry air in the passenger compartment.

⚠ WARNING

- Continuously using the climate control system in the recirculated air position may allow humidity to increase inside the vehicle which may fog the glass and obscure visibility.
- Do not sleep in a vehicle with the air conditioning or heating system on. It may cause serious harm or death due

to a drop in the oxygen level and/or body temperature.

- Continuously using the climate control system in the recirculated air position can cause drowsiness or sleepiness, and loss of vehicle control. Set the air intake control to the outside (fresh) air position as much as possible whilst driving.

Controlling fan speed

The fan speed control knob allows you to control the fan speed of the air flowing from the ventilation system.

The ignition switch or the ENGINE START/STOP Button must be in the ON position for fan operation.

- To change the fan speed:
- Turn the knob to the right for higher speed or left for lower speed.



OBD041310L

To turn off the blowers:

- Turn the fan speed control knob to the "0" position.

Air conditioning (A/C)

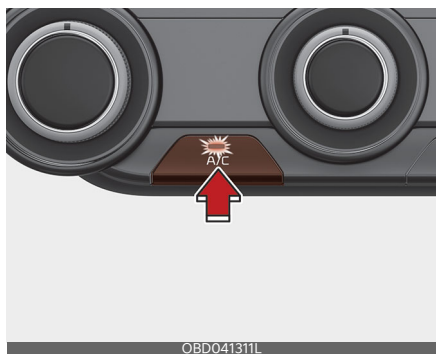

- Press the A/C button to turn the air conditioning system on (indicator light will illuminate).
- Press the button again to turn the air conditioning system off.

Automatic climate control system (if equipped)

The automatic climate control system uses cooling and heating to help maintain a pleasant environment inside the vehicle.

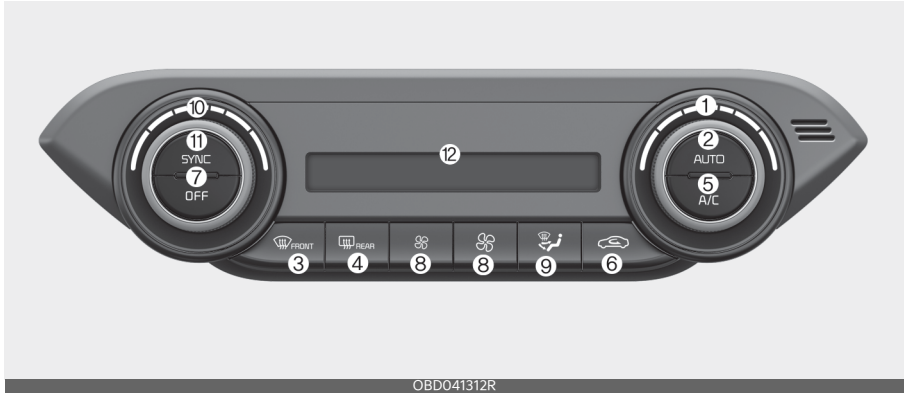

1. Driver's temperature control knob
2. AUTO (automatic control) button
3. Front windscreen defroster button
4. Rear window defroster button
5. Air conditioning button
6. Air intake control button
7. Blower OFF button
8. Fan speed control button
9. Mode selection button
10. Passenger's temperature control knob
11. SYNC button
12. A/C display

* NOTICE

Operating the blower when the ignition switch or ENGINE START/STOP button is in the ON position could cause the battery to discharge. Operate the blower when the engine is running.

Heating and air conditioning automatically

1. Press the AUTO button.

The modes, fan speeds, air intake and air-conditioning will be controlled automatically by setting the temperature.



OBDO41313R

2. Set the temperature control knob to set the desired temperature.



OBDO41333R

* NOTICE

- To turn the automatic operation off, select any button or switch of the following:
 - Mode selection button
 - Air conditioning button
 - Front windscreen defroster button (Press the button one more time to deselect the front windscreen

defroster function. The AUTO sign will illuminate on the information display once again.)

- Fan speed control knob

The selected function will be controlled manually whilst other functions operate automatically.

- For your convenience and to improve the effectiveness of the climate control, use the AUTO button and set the temperature to 22 °C (72 °F).

* NOTICE

Never place anything over the sensor located on the instrument panel to ensure better control of the heating and cooling system.

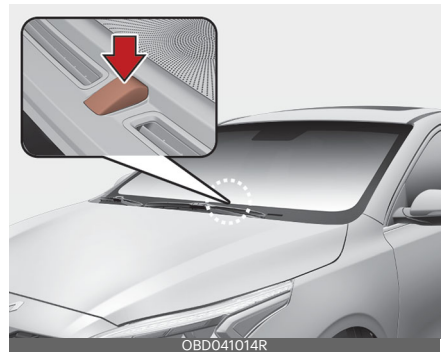



OBDO41014R

Heating and air conditioning manually

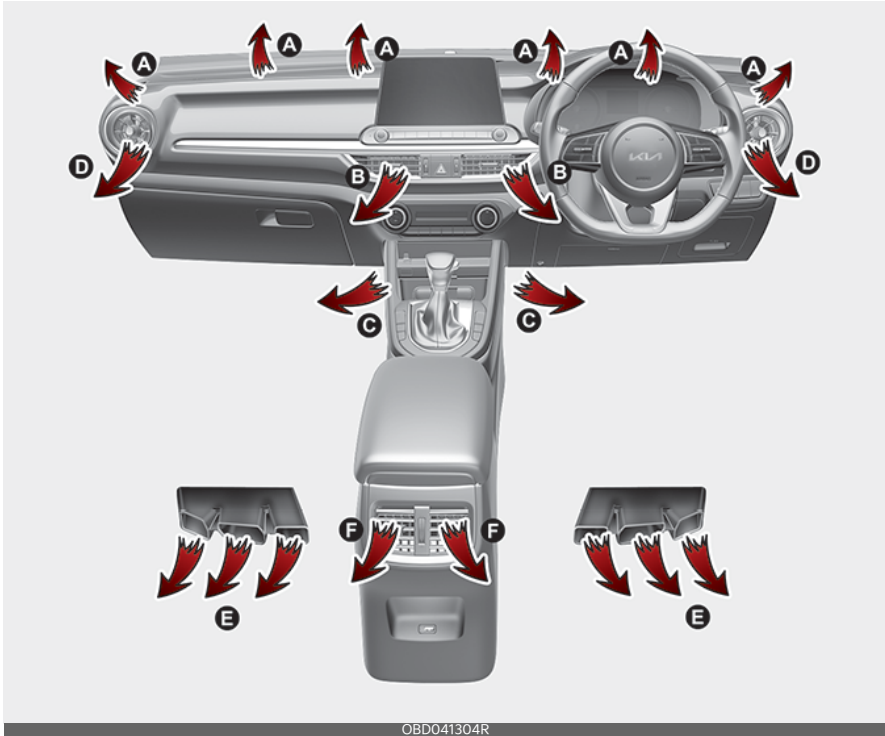
The heating and cooling system can be controlled manually by pressing buttons other than the AUTO button.



In this case, the system works sequentially according to the order of buttons selected.

1. Start the vehicle.
2. Set the mode to the desired position.
 - For improving the effectiveness of heating and cooling;
 - Heating: 
 - Cooling: 
3. Set the temperature control to the desired position.
4. Set the air intake control to the outside (fresh) air position.
5. Set the fan speed control to the desired speed.

If air conditioning is desired, turn the air conditioning system on.

Press the AUTO button in order to convert to fully automatic control of the system.

Mode selection

The mode selection button controls the direction of the air flow through the ventilation system.



The air flow outlet ports are switched in the following sequence:



Face-Level (B, D, F)

Air flow is directed toward the upper body and face. Additionally, each outlet can be controlled to direct the air discharged from the outlet.

Bi-Level (B, C, D, E, F)

Air flow is directed towards the face and the floor.

Floor-Level (A, C, D, E, F)

Most of the air flow is directed to the floor, with a small amount of the air being directed to the windscreen, side window defrosters and side air vents.

Floor/Defrost-Level (A, C, D, E, F)

Most of the air flow is directed to the floor and the windscreen with a small amount directed to the side window defrosters and side air vents.

Defrost mode

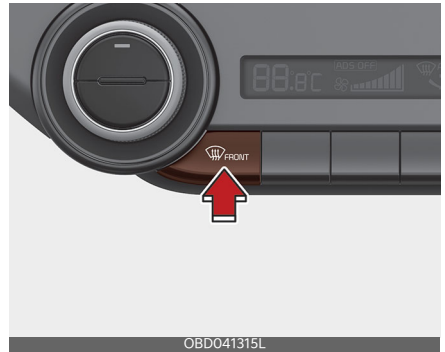

When you select the defrost mode, the following system settings will be made automatically:

- The air conditioning system will be turned on.
- The outside (fresh) air position will be selected.
- The fan speed will be set to the high speed.

To turn the defrost mode off, press the mode button or defrost button again or AUTO button.

Instrument panel vents

Type A



Type B

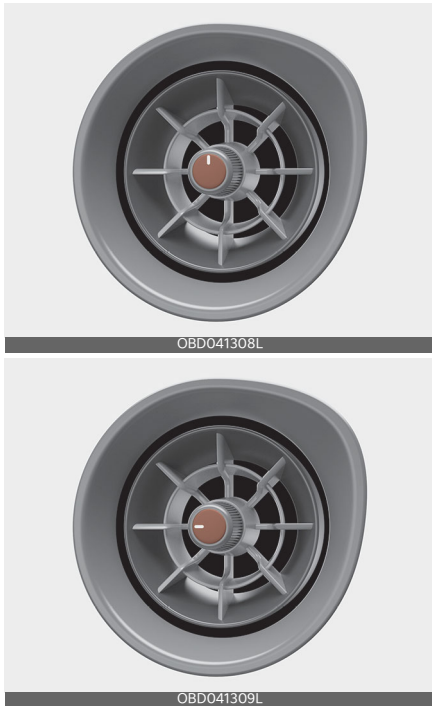

- Type A

The outlet vents can be opened or closed separately using the thumbwheel. To close the vent, rotate it downward to the maximum position. Also, you can adjust the direction of air delivery from these vents using the vent control lever as shown.

- Type B

The outlet vents can be opened or closed separately turning the knob right or left. Also, you can adjust the direction of air delivery from these vents moving the knob freely to any directions.

Temperature control

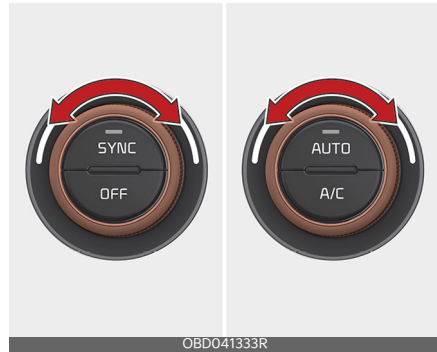

The temperature will increase to the maximum (HI) by rotating the knob clockwise direction.

The temperature will decrease to the minimum (Lo) by rotating the knob anti clock wise direction.

When rotating the knob, the temperature will increase or decrease by 0.5 °C. When set to the lowest temperature setting, the air conditioning will operate continuously.

Adjusting the driver and passenger side temperature equally



1. Press the "SYNC" button to adjust the driver and passenger side temperature equally.

The passenger side temperature will be set to the same temperature as the driver side temperature.

2. Turn the driver side temperature control knob. The driver and passenger side temperature will be adjusted equally.
3. When the third row's seat heater button is turned ON, the third row's climate and fan speed setting will automatically follow the first row settings.

Adjusting the driver and passenger side temperature individually

1. Press the "SYNC" button again to adjust the driver and passenger side temperature individually. The button indicator will turn off.
2. Operate the driver side temperature control knob to adjust the driver side temperature.
3. Operate the passenger side temperature control knob to adjust the passenger side temperature.

Temperature conversion (°C ↔ °F)

You can switch the temperature mode between Centigrade to Fahrenheit as follows; whilst pressing the OFF button, depress the AUTO button for 3 seconds or more. The display will change from Centigrade to Fahrenheit, or from Fahrenheit to Centigrade.

Controlling air intake

This is used to select the outside (fresh) air position or recirculated air position.

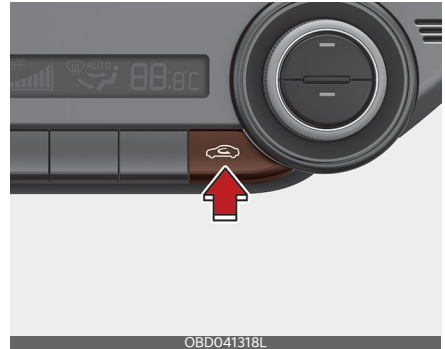

To change the air intake control position:

- Push the desired control button.

Recirculated air position



With the recirculated air position selected,

air from the passenger compartment will be drawn through the heating system and heated or cooled according to the function selected.

Outside (fresh) air position



With the outside (fresh) air position selected,

air enters the vehicle from outside and is heated or cooled according to the function selected.

* NOTICE

Prolonged operation of the heater in the recirculated air position (without air conditioning selected) may cause fogging of the windscreen and side windows and the air within the passenger compartment may become stale.

In addition, prolonged use of the air conditioning with the recirculated air posi-

tion selected will result in excessively dry air in the passenger compartment.

WARNING

- Continued climate control system operation in the recirculated air position may allow humidity to increase inside the vehicle which may fog the glass and obscure visibility.
- Do not sleep in a vehicle with the air conditioning or heating system on. It may cause serious harm or death due to a drop in the oxygen level and/or body temperature.
- Continued climate control system operation in the recirculated air position can cause drowsiness or sleepiness, and loss of vehicle control. Set the air intake control to the outside (fresh) air position as much as possible whilst driving.

Controlling fan speed

The fan speed can be set to the desired speed by operating the fan speed control button.

To change the fan speed:

- Press button right for higher speed, or press button left for lower speed.

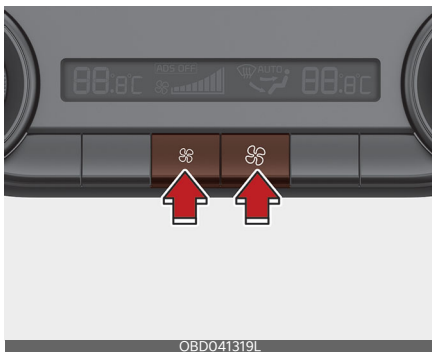

To turn the fan speed control off:

- Press the OFF button.

Air conditioning (A/C)



- Press the A/C button to turn the air conditioning system on (indicator light will illuminate).
- Press the button again to turn the air conditioning system off.

Turning off the front air climate control





- Press the OFF button to turn off the air climate control system. However, you can still operate the mode and air intake buttons as long as the ignition switch or the ENGINE START/STOP Button is in the ON position.

Windscreen defrosting and defogging

When the windscreen is covered with frost or moisture, the front view is blurred, you should remove the frost and moisture.

⚠ WARNING



Windscreen heating

Do not use the  or  position during cooling operation in extremely humid weather. The difference between the temperature of the outside air and the windscreen could cause the outer surface of the windscreen to fog up, causing loss of visibility. In this case, set the mode selection to the  position and fan speed control to the lower speed.

- For maximum defrosting, set the temperature control to the extreme right/hot position and the fan speed control to the highest speed.
- If warm air to the floor is desired whilst defrosting or defogging, set the mode to the floor-defrost position.
- Before driving, clear all snow and ice from the windscreen, rear window, outside rear view mirrors, and all side windows.
- Clear all snow and ice from the bonnet and air inlet in the cowl grill to improve heater and defroster efficiency and to reduce the probability of fogging up the inside of the windscreen.

Defogging inside windscreen with manual climate control system



1. Select any fan speed except "0" position.
2. Select desired temperature.
3. Select the  or  position.
4. The outside (fresh) air and air conditioning will be selected automatically.

If the air conditioning and outside (fresh) air position are not selected automatically, press the corresponding button manually.

Defrosting outside windscreen with manual climate control system



1. Set the fan speed to the highest (extreme right) position.
2. Set the temperature to the extreme hot position.
3. Select the  position.
4. The outside (fresh) air and air conditioning will be selected automatically.

Defogging inside windscreen with automatic climate control

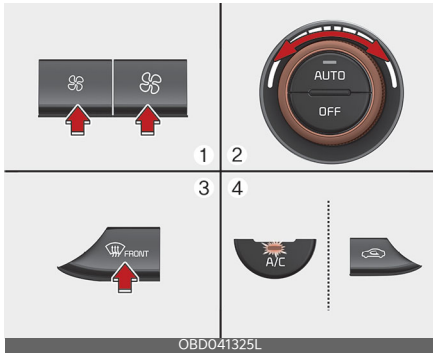

1. Set the fan speed to the desired position.
2. Select desired temperature.
3. Press the defroster button (.
4. The outside (fresh) air position will be selected automatically and the air conditioning will turn on according to the detected ambient temperature.

If the air conditioning and outside (fresh) air position are not selected automatically, adjust the corresponding button manually. If the  position is selected, lower fan speed is adjusted to a higher fan speed.

Defrosting outside windscreen with automatic climate control

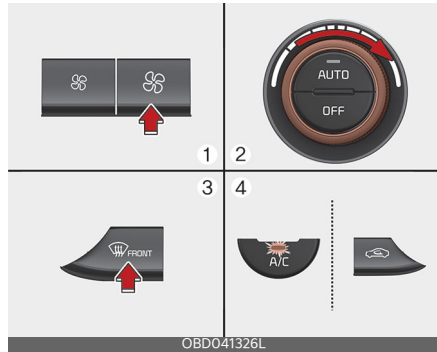

1. Set the fan speed to the highest position.
2. Set the temperature to the extreme hot (HI) position.
3. Press the defroster button (.
4. The outside (fresh) air position will be selected automatically and the air conditioning will turn on according to the detected ambient temperature.

Auto defogging system (only for automatic climate control system)

Auto defogging helps reduce the possibility of fogging up the inside of the windscreen by automatically sensing the moisture on inside the windscreen.

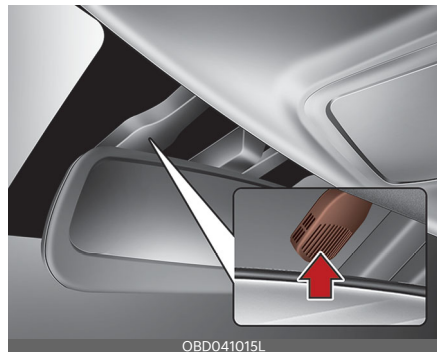



The auto defogging system operates when the heater or air conditioning is on.

When the Auto Defogging System operates, the indicator will illuminate.

If a high amount of humidity is detected in the vehicle, the Auto Defogging System will be enabled.

The following steps will be performed automatically:

1. The A/C button will turn ON.
2. The air intake control will change to Fresh mode under low outside temperature.
3. The mode will be changed to defrost to direct airflow to the windscreen.
4. The fan speed will be increased.

To cancel or reset the Auto Defogging System

Press the front windscreen defroster button for 3 seconds when the ignition switch or ENGINE START/STOP button is in the ON position.

When the Auto Defogging System is cancelled, defrost button indicator will blink 3 times.

When the Auto Defogging System is reset, defrost button indicator will blink 6 times without a signal.

*** NOTICE**

- When the air conditioning is turned on by Auto defogging system, if you try to turn off the air conditioning, the indicator will blink 3 times and the air conditioning will not be turned off.
- To maintain the effectiveness and efficiency of the Auto Defogging System, do not select Recirculation mode whilst the system is operating.

- When the Auto Defogging System is operating, the fan speed adjustment knob, the temperature adjustment knob, and the air intake control button are all disabled.

*** NOTICE**

Do not remove the sensor cover located on the upper end of the driver side windscreen glass.

Damage to system parts could occur and may not be covered by your vehicle warranty.

Sunroof inside air recirculation

The outside (fresh) air position is automatically selected, when the sunroof is opened. When you select the recirculated air position, the system maintains the recirculated air position for 3 minutes and then automatically converts to the outside (fresh) air position. When the sunroof is closed, the air intake position will return to the original position that was selected.

Automatic Air Ventilation

When operating heater and air conditioner for the vehicle ventilation, if you maintain the Recirculation mode for 30 minutes or over at low temperature, it automatically changes to Fresh mode.

Automatic Air Ventilation control procedure

When set up or release the automatic air ventilation function, select the Mode Selection button at heater or air conditioner on. And press the Air Intake Control button for 5 times or over within 3 seconds together within 3 seconds together within 3 seconds together with pressing the Air conditioning button. When release the automatic ventilation

function, the Recirculation mode indicator will blink 3 times at 0.5 second intervals and air direction, air volume, Recirculation/Fresh mode, and air conditioner is automatically controlled.

When it set the automatic ventilation function, the Recirculation mode indicator will blink 6 times at 0.25 seconds intervals and air direction, air volume, Recirculation/Fresh mode, and air conditioner is automatically controlled. Auto dehumidify is activated when you select 'Settings → Vehicle → Climate → Automatic Ventilation → Auto dehumidify' from the Settings in the Infotainment System screen.

For more details, please scan the QR code in a separately supplied Car Infotainment System Quick Reference Guide.

Activate upon Washer Fluid Use

To prevent the odor from entering to inside the vehicle, the ventilation system changes to Recirculated Air Mode for a whilst when the windscreen washer fluid sprayed.

However, at low outside temperature, to prevent from windscreen fogging, the system continues to outside air mode.

System setting

1. ignition switch or the ENGINE START/ STOP Button is ON.
2. Select Floor-Level (🌀) air flow direction by pressing Mode Selection button.
3. With pressing Air Conditioning button, press the Recirculated Air button more than 4 times within 2 seconds.
4. If the system is set up, the indicator on Recirculated Air button will blinks 6 times.

System cancellation

1. ignition switch or the ENGINE START/ STOP Button is ON.
2. Select Floor-Level (🌀) air flow direction by pressing Mode Selection button.
3. With pressing Air Conditioning button, press the Recirculated Air button more than 4 times within 2 seconds.
4. If the system is cancelled, the indicator on Recirculated Air button will blinks 3 times.

Activation on washer fluid is activated when you select 'Settings → Vehicle → Climate → Recirculate Air → Activate upon Washer Fluid Use' from the Settings in the Infotainment System screen.

For more details, please scan the QR code in a separately supplied Car Infotainment System Quick Reference Guide.

Recirculation Mode Plus (if equipped)

To prevent the inflow of polluted air indoors when passing through the tunnel and odor area, this function automatically switches the air conditioner to Recirculation Mode about 7 seconds before the vehicle enters the tunnel based on the map information of the navigation and the speed of the vehicle.

Operating Condition

- Type of Road: Expressway,
- Air Intake Condition: Fresh Mode

You may activate or deactivate this function from the Settings in the Infotainment System screen as 'Settings → Vehicle → Climate → Recirculate Air → Recirculation Mode Plus'.

For more details, please scan the QR code in a separately supplied Car Info-

ainment System Quick Reference Guide.

Defroster

The vehicle is equipped with a defroster for removing frost or fog from the rear window.

⚠ CAUTION

Conductors

To prevent damage to the conductors bonded to the inside surface of the rear window, never use sharp instruments or window cleaners containing abrasives to clean the window.

If you want to defrost and defog the front windscreen, refer to "Windscreen defrosting and defogging" on page 4-133.

Operating rear window defroster

The defroster heats the window to remove frost, fog and thin ice from the rear window, whilst the engine is on. If there is heavy accumulation of snow on the rear window, brush it off before operating the rear defroster.

Type A/Type B

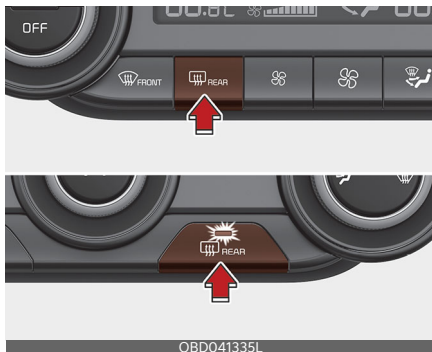

To activate the rear window defroster:

- Press the rear window defroster button located in the heater control panel.

The indicator on the rear window defroster button illuminates when the defroster is ON.

The rear window defroster automatically turns off after approximately 20 minutes or when the ignition switch or the ENGINE START/STOP Button is turned off.

To turn off the defroster:

- Press the rear window defroster button again.

Outside mirror defroster (if equipped)

If your vehicle is equipped with the outside mirror defrosters, they will operate at the same time you turn on the rear window defroster.



*** NOTICE**

The rear window defroster may turn off in the below conditions.

- Engine temperature is less than 25°C and the vehicle speed is from 1~10 km/h with the gear position in "D" or "R".

If the vehicle stops or the vehicle speed is over 10 km/h, the rear window defroster turns on again.

Defogging logic (if equipped)

To reduce the possibility of fogging up the inside of the windscreen, the air intake or air conditioning is controlled automatically according to certain conditions such as  or  position.

To cancel automatic defogging logic or return to the automatic defogging logic, do the following.

Canceling/returning automatic defogging logic on manual climate control system



1. Turn the vehicle to the ON position.
2. Select the (FRONT) position.
3. whilst holding the air conditioning button (A/C) pressed, press the air intake control button at least 5 times within 3 seconds.

The indicator light in the air intake control button will blink 3 times. It indicates that the defogging logic is cancelled or returned to the programmed status.

If the battery has been discharged or disconnected, it resets to the defog logic status.

Canceling/returning automatic defogging logic

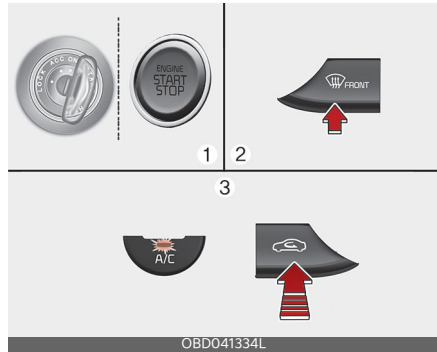

1. Turn the vehicle to the ON position.
2. Press the defroster button (FRONT).
3. whilst pressing the air conditioning (A/C) button, press the air intake control button at least 5 times within 3 seconds.

The recirculation indicator blinks 3 times in 0.5 second of intervals. It indicates that the defogging logic is cancelled or returned to the programmed status.

If the battery has been discharged or disconnected, it resets to the defog logic status.

Storage compartment

These compartments can be used to store small items required by the driver or passengers.

⚠ CAUTION

- To avoid possible theft, do not leave valuables in the storage compartment.
- Always keep the storage compartment covers closed whilst driving. Do not attempt to place so many items in the storage compartment that the storage compartment cover cannot close securely.

⚠ WARNING

Flammable materials

Do not store, propane cylinders or other flammable/explosive materials in the vehicle. These items may catch fire and/or explode if the vehicle is exposed to hot temperatures for extended periods.

Centre console storage

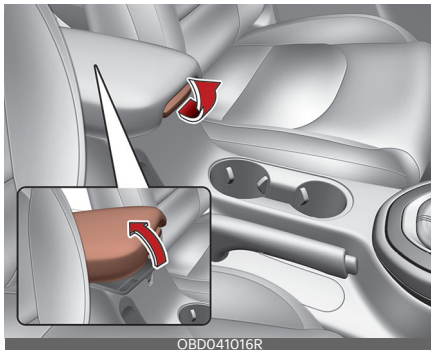

To open the centre console storage:

- Pull up the lever.

Glove box

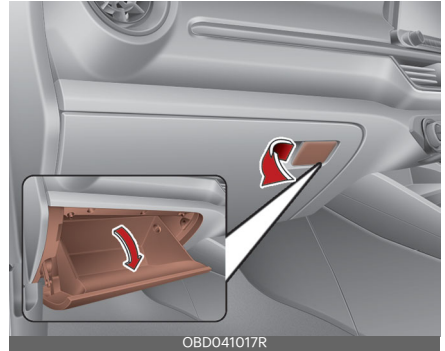

To open the glove box:

- Pull the handle and the glove box will automatically open.

Close the glove box after use.

⚠ WARNING

Glove box

To reduce the risk of injury in an accident or sudden stop, always keep the glove box door closed whilst driving.

⚠ CAUTION

Do not keep food in the glove box for a long time.

Sunglass holder (if equipped)

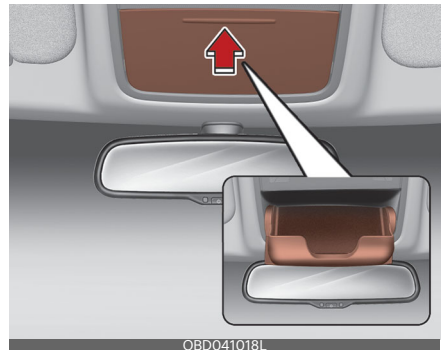

To open the sunglasses holder, press the cover and the holder will slowly open. Place your sunglasses with the lenses facing out. To close the sunglasses holder, push it up.

Interior features

There are various features inside the vehicle for the convenience of the occupants.

Cigarette lighter (if equipped)

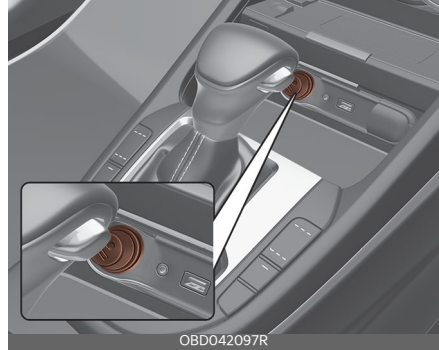

For the cigarette lighter to work, the ignition switch must be in the ACC position or the ON position. To use the cigarette lighter, push it all the way into its socket. When the element has heated, the lighter will pop out to the “ready” position. Kia recommends to use parts for replacement from an authorised Kia dealer/service partner.

Ashtray

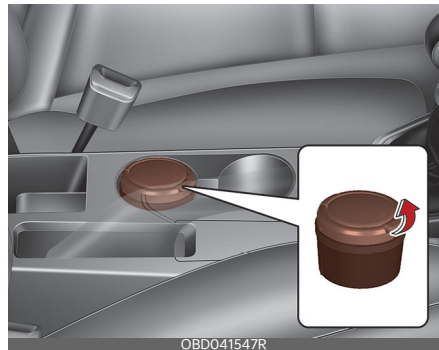

- To use the ashtray, open the cover.

- To clean or empty the ashtray, pull it out.

Use the ashtray by leaning it to the cup holder right beside.

⚠ WARNING

Ashtray use

- Do not use the vehicle's ashtrays as waste receptacles.
- Putting lit cigarettes or matches in an ashtray with other combustible materials may cause a fire.

Cup holder

Front

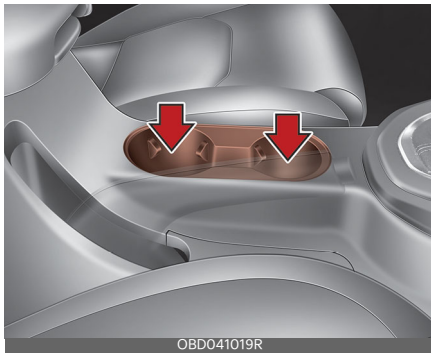

Rear (if equipped)



Cups or small beverage cans may be placed in the cup holders.

⚠ WARNING

Hot liquids

- Do not place uncovered cups with hot liquid in the cup holder whilst the vehicle is in motion. If the hot liquid spills, you burn yourself. Such a burn to the driver could lead to loss of control of the vehicle.
- To reduce the risk of personal injury in the event of sudden stop or collision, do not place uncovered or unsecured bottles, glasses, cans, etc., in the cup holder whilst the vehicle is in motion.

⚠ WARNING

Keep cans or bottles out of direct sun light and do not put them in a vehicle that is heated up. It may explode.

*** NOTICE**

- Keep your drinks sealed whilst driving to prevent spilling your drink. If liquid spills, it may get into the vehicle's electrical/electronic system and damage electrical/ electronic parts.
- When cleaning spilled liquids, do not dry the cup holder at high temperature. This may damage the cup holder.

Sliding armrest (if equipped)

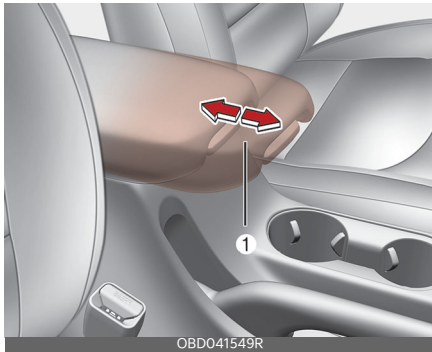

To move forward

Grab the front portion of the armrest then press up the lever (1) and pull it forward.

To move rearward

Push the armrest rearward with your palm.

⚠ WARNING

Do not grab the front portion of the armrest (1) when moving the armrest rearward. It may pinch your fingers.

Seat warmer

The seat warmer is provided to warm the front seats during cold weather.

Front seat

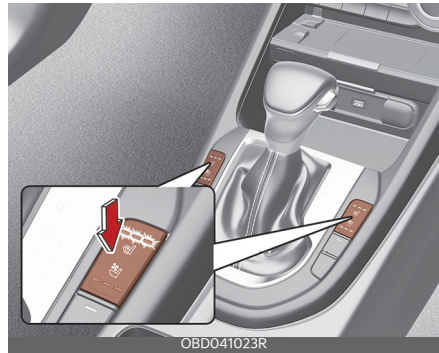

Rear seat

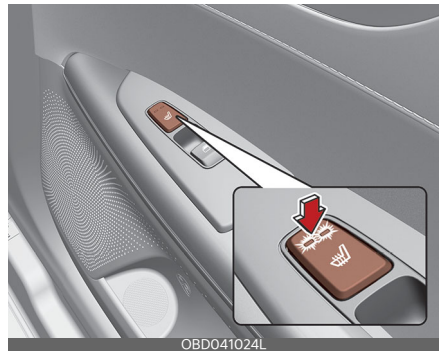

With the ignition switch or ENGINE START/STOP button in the ON position:

- Push either of the buttons to warm the driver's seat or the front passenger's seat.

During mild weather or under conditions where the operation of the seat warmer is not needed, keep the levers/switch in the "OFF" position.

Temperature control (Manual)

- Each time you press the button, the temperature setting of the seat will change as follows:
 - Front seat

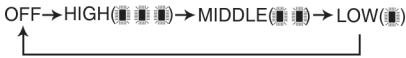

- Rear seat



- The seat warmer defaults to the OFF position whenever the ignition switch or ENGINE START/STOP button is turned on.

Temperature control (Automatic)

The seat warmer starts to automatically control the seat temperature in order to prevent low-temperature burns after being manually turned ON.

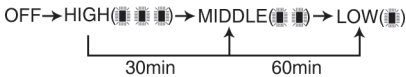

You may manually press the button to increase the seat temperature. However, it soon returns to the automatic mode again.

- When pressing the button for more than 1.5 seconds with the seat warmer operating, the seat warmer will turn OFF.
- The seat warmer defaults to the OFF position whenever the ignition switch or the ENGINE START/STOP Button is in the ON position.

* NOTICE

With the seat warmer button in the ON position, the heating system in the seat turns off or on automatically depending on the seat temperature.

⚠ CAUTION

- When cleaning the seats, do not use an organic solvent such as paint thinner, benzene, alcohol and petrol. Doing so may damage the surface of the heater or seats.
- To prevent overheating the seat warmer, do not place anything on the seats that insulates against heat, such as blankets, cushions or seat covers whilst the seat warmer is in operation.
- Do not place heavy or sharp objects on seats equipped with seat warmers. Damage to the seat warming components could occur.
- Do not change the seat cover. It may damage the seat warmer or air ventilation system.

⚠ WARNING

Seat warmer burns

Passengers should use extreme caution when using seat warmers due to the possibility of excess heating or burns. The seat warmer may cause burns even at low temperatures, especially if used for long periods of time. In particular, the driver must exercise extreme care for the following types of passengers:

1. Infants, children, elderly or handicapped persons, or hospital outpatients
2. Persons with sensitive skin or those that burn easily
3. Fatigued individuals
4. Intoxicated individuals
5. Individuals taking medication that can cause drowsiness or sleepiness (sleeping pills, cold tablets, etc.)

Air ventilation seat

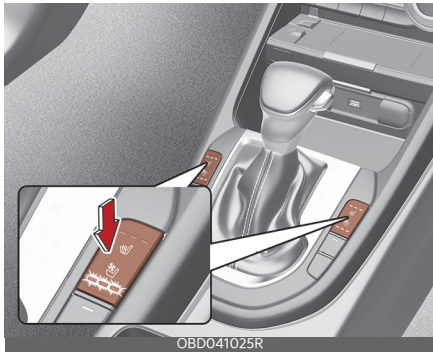

OBD041025R

The temperature setting of the seat changes according to the button position.

- To ventilate your seat cushion, press the button.

Each time you press the button, the airflow will change as follows:

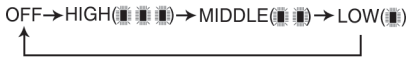

The seat warmer (with air ventilation) defaults to the OFF position whenever the ignition switch or the ENGINE START/STOP Button is turned on.

⚠ CAUTION

Seat damage

- When cleaning the seats, do not use an organic solvent such as paint thinner, benzene, alcohol and petrol. Doing so may damage the air ventilation seat.

Sun visor

Use the sun visor to shield direct light through the front or side windows.

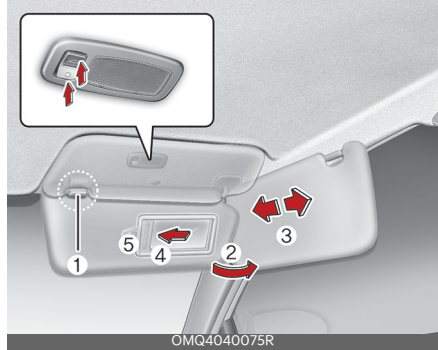

OMQ4040075R

- To use the sun visor, pull it downward.
- To use the sun visor for the side window, pull it downward, unsnap it from the bracket (1) and swing it to the side (2). You can slide the sun visor if necessary (3) (if equipped).
- To use the vanity mirror, pull down the visor and slide the mirror cover (4).

Press the ON button (☀) to turn on the lamp inside the sun visor when using a mirror. Before returning the sun visor to the original position, be sure to press the OFF button (○) to turn it off.

The ticket holder (5) is provided for holding a tollgate ticket.

⚠ WARNING

For your safety, do not block your view when using the sun visor.

* NOTICE

Do not put several tickets in the ticket holder at one time. This could cause damage to the ticket holder.

USB charger (if equipped)

The USB car charger allows drivers to charge their digital devices like smart-phones, and PC tablets.

Front

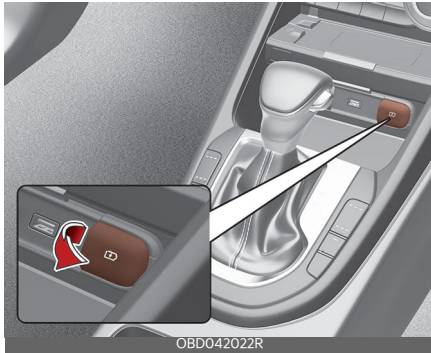

2nd row (if equipped)



Plug the cable to the USB port, charging will begin.

The USB car charger is available with either the ACC or the ignition on. We recommend you to connect the USB port and digital devices with the engine running. See the display screen of the device to check its charging process completion. Your smart phone or table PC could get heated up whilst charging. This is no reason to worry, as it doesn't impact life or functions of the device. For the safety

reason, charging can be stopped if the battery gets heated up to a certain point of temperature that the devices can be negatively affected. Charging some digital devices is not available or requires special dedicated adapters if their charging methods don't fit the way the USB car charger works. Quick Charge 2.0 is available on the smart phone or the table PC equipped with fast charging capabilities. The applicable is as follows: (<https://www.qualcomm.com/documents/quick-charge-device-list>)

The smart phone or PC tablet without fast charging is charged at a regular speed.

Rated output:

- Digital devices with fast charging:
 - 9.0 V, 1.67 A
- Digital devices with normal charging:
 - 5.0 V, 2.1 A

⚠ CAUTION

- Use the USB car charger with the ignition on. Otherwise, Vehicle battery can be discharged.
- Use the official USB cable of the manufacturer of the digital device to be charged.
- Make sure that any foreign object, drinks, and water do not come into contact with the USB car charger. Water or foreign object can damage the USB charger.
- Do not use the device those current consumption exceeds 2.1 A.
- Do not connect an electrical device that generates excessive electromagnetic noise to the USB car port. If you do so, noise can be caused or vehicle electronic devices can be interrupted whilst audio or AV is on.

- If the charger is connected incorrectly, it can cause serious damage on the devices. Please note that damages due to incorrect usage are not covered by warranty service.

Power outlet (if equipped)

The power outlet is designed to provide power for mobile telephones or other devices designed to operate with vehicle electrical systems.

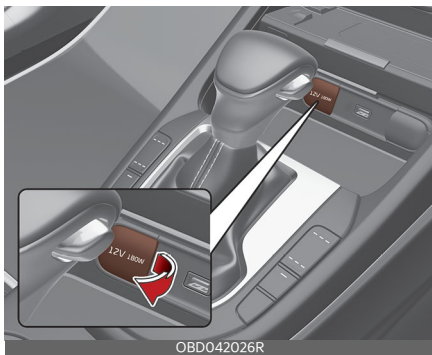

OBD042026R

The devices should draw less than 15 amps with the vehicle on.

⚠ WARNING

- Use the power outlet only when the vehicle is on and remove the accessory plug after use. Using the accessory plug for prolonged periods of time with the vehicle off could cause the battery to discharge.
- Only use 12 V electric accessories which are less than 15 A in electric capacity.
- Adjust the air-conditioner or heater to the lowest operating level when using the power outlet.
- Close the cover when not in use.
- Some electronic devices can cause electronic interference when plugged into a vehicle's power outlet. These

devices may cause excessive audio static and malfunctions in other electronic systems or devices used in your vehicle.

- Push the plug in as far as it will go. If good contact is not made, the plug may overheat and the fuse may open.
- Plug in battery equipped electronic devices with reverse current protection. The current from the battery may flow into the vehicle's electrical/electronic system and cause system malfunction.

⚠ WARNING

Electric shock

Do not put a finger or a foreign object (pen, etc.) into a power outlet and do not touch with a wet hand. You may get an electric shock.

Wireless smart phone charging system (if equipped)

A wireless smart phone charging system is located in front of the centre console.

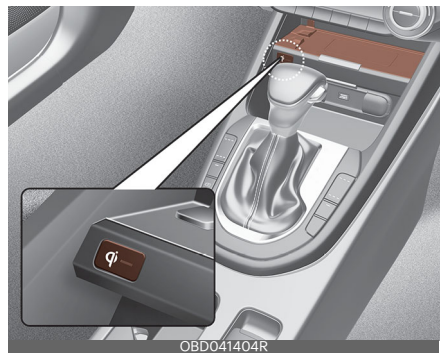

OBD041404R

Firmly close all doors, and the ignition switch or ENGINE START/STOP button is ON. To start wireless charging, place the smart phone equipped with wireless

charging function on the wireless charging pad.

For best wireless charging results, place the smart phone on the centre of the charging pad.

The wireless charging system is designed for one smart phone equipped with Qi only. Please refer to the smart phone accessory cover or the smart phone manufacturer homepage to check whether your smart phone supports Qi function.

WARNING

If any metallic object such as coins is located between the wireless charging system and the smart phone, the charging may be disrupted. Also, the metallic object may heat up.

Wireless smart phone charging

1. Remove any object on the smart phone charging pad including the smart key. If there is any foreign object on the pad other than a smart phone, the wireless charging function may not operate properly.
2. Place the smart phone on the centre of the wireless charging pad.
3. The indicator light will change to orange once the wireless charging begins. After the charging is complete, the orange light will change to green.
4. You can choose to turn the wireless charging function to either ON or OFF by selecting the USM on the instrument cluster. (Please refer to "Instrument cluster" on page 4-52 for details).

If the wireless charging does not work, gently move your smart phone around the pad until the charging indicator light

turns yellow. Depending on the smart phone, the charging indicator light may not turn green even after the charging is complete.

If the wireless charging is not functioning properly, the orange light will blink and flash for ten seconds then turn off. In such cases, remove the smart phone from the pad and replace it on the pad again, or double check the charging status.

If you leave the smart phone on the charging pad when the vehicle ignition is in OFF, the vehicle will alert you through warning messages and sound (applicable for vehicles with voice guidance function) after the 'Good bye' function on the instrument cluster ends.

NOTICE

For some manufacturers' smart phones, the system may not warn you even though the smart phone is left on the wireless charging unit. This is due to the particular characteristic of the smart phone and not a malfunction of the wireless charging.

CAUTION

- When the interior temperature of the wireless charging system rises above a set temperature, the wireless charging will cease to function. After the interior temperature drops below the threshold, the wireless charging function will resume.
- If there is any metallic object between the smart phone and the wireless charging pad, immediately remove the smart phone. Remove the metallic object after it has completely cooled down.

- The wireless charging may not function properly when there is a heavy accessory cover on the smart phone.
- The wireless charging will stop when using the wireless smart key search function to prevent radio wave disruption.
- The wireless charging will stop when the smart key is moved out of the vehicle with the ignition in ON.
- The wireless charging will stop when any of the doors is opened (applicable for vehicles equipped with smart keys).
- The wireless charging will stop when the vehicle is turned OFF.
- The wireless charging will stop when the smart phone is not in complete contact with the wireless charging pad.
- Items equipped with magnetic components such as credit card, telephone card, bankbook, any transportation ticket and such may become damaged during wireless charging.
- Place the smart phone on the centre of the charge pad for best results. The smart phone may not charge when placed near the rim of the charging pad. When the smart phone does get charged, it may heat up excessively.
- For smart phones without builtin wireless charging system, an appropriate accessory has to be equipped.
- Smart phones of some manufacturers may display messages on weak current. This is due to the particular characteristic of the smart phone and does not imply a malfunction on wireless charging function.
- The indicator light of some manufacturers' smart phones may still be yellow

after the smart phone is fully charged. This is due to the particular characteristic of the smart phone and not a malfunction of the wireless charging.

- When any smart phone without a wireless charging function or a metallic object is placed on the charging pad, a small noise may sound. This small sound is due to the vehicle discerning compatibility of the object placed on the charging pad. It does not affect your vehicle or the smart phone in any way.
- The wireless mobile phone charging system may not support certain mobile phones, which are not verified for the Qi specification (Qi).
- For certain mobile phones with their own protection, the wireless charging speed may decrease and the wireless charging may stop.

Coat hook

A Coat hook is next to the rear grab handle.

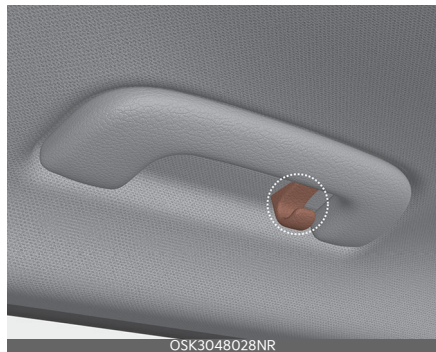

* This actual feature may differ from the illustration.

⚠ CAUTION

Hanging clothing

Do not hang heavy clothes, since they may damage the hook.

⚠ WARNING

Do not hang other objects such as hangers or hard objects except clothes. Also, do not put heavy, sharp or breakable objects in the clothing's pockets. In an accident or when the curtain air bag is inflated, it may cause vehicle damage or body injury.



Luggage net holder (if equipped)

To keep items from shifting in the cargo area, you can use the 4 holders located in the cargo area to attach the luggage net, or you can fold the luggage net into half and attach it upwards by using the additional 2 holders located on each side.

4 Door

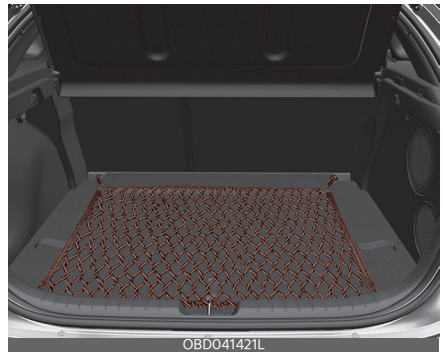
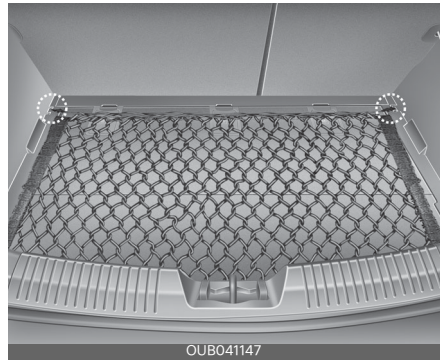

If necessary, Kia recommends to contact an authorised Kia dealer/service partner.

⚠ CAUTION

To prevent damage to the goods or the vehicle, care should be taken when carrying fragile or bulky objects in the luggage compartment.

⚠ WARNING

Avoid eye injury. DO NOT overstretch the luggage net, ALWAYS keep your face and body out of the luggage net's recoil path. DO NOT use when the strap has visible signs of wear or damage.

Cargo area cover (if equipped)

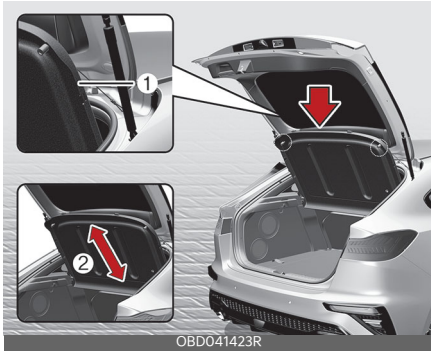

Use the cover to hide items stored in the cargo area. The cargo area cover will be lifted when the tailgate is opened. Disconnect the strap (1) from holder if you want to return the cover to original position. To remove the cargo area cover completely, lift the cover to a 43-degree angle and pull it out to the full (2). For installation of the cover, reverse the removal procedure.

⚠ CAUTION

- When you return the cargo area cover to its original position, hold the cover and lower it.
- Do not operate the vehicle with the cover removed. It may damage to the cover.
- The cargo area cover may be lifted when the tailgate is opened. Ensure that the luggage on the cover is moved to a safe place.
- Since the cargo area cover may be damaged or malformed, do not apply excessive force to the cover or do not put the heavy loads on it.

⚠ WARNING

- Do not place objects on the cargo area cover whilst driving. Such objects may be thrown about inside the vehicle and possibly injure vehicle occupants during an accident or when braking.
- Never allow anyone to ride in the luggage compartment. It is designed for luggage only.
- Maintain the balance of the vehicle and locate the weight as far forward as possible.

Shopping bag holder (if equipped)

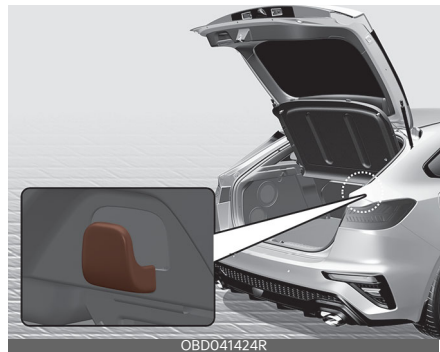

⚠ CAUTION

- Do not hang a bag weighing more than 3 kg (7 lbs.). It may cause damage to the shopping bag holder.
- Do not hang the frail objects when you drive rough road, the objects may be damaged.

Luggage tray (if equipped)

You can place a first aid kit, a reflector triangle, tools, etc. in the box for easy access.

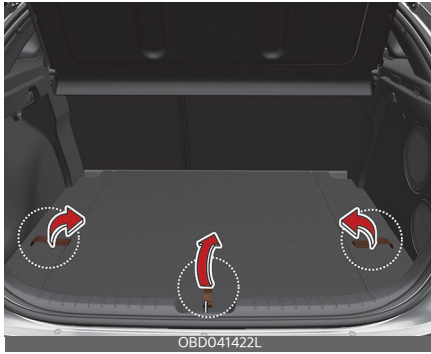

- Grasp the handle on the top of the cover and lift it.

Infotainment system	5-3
• Antenna	5-3
• Micro pole antenna	5-3
• USB port	5-4
• How vehicle radio works.....	5-4
Audio (Without Touch Screen)	5-7
• System layout - control panel.....	5-7
• System layout - steering wheel remote control.....	5-10
• Turning the system on or off	5-12
• Turning the display on or off	5-12
• Getting to know the basic operations.....	5-12
Radio	5-14
• Turning on the radio.....	5-14
• Changing the radio mode	5-16
• Scanning for available radio stations.....	5-17
• Searching for radio stations	5-17
• Saving radio stations.....	5-17
• Listening to saved radio stations	5-17
Media player	5-18
• Using the media player	5-18
• Using the USB mode	5-18
Bluetooth	5-21
• Connecting Bluetooth devices	5-21
• Using a Bluetooth audio device.....	5-23
• Using a Bluetooth phone.....	5-25
ERA-GLONASS EMERGENCY CALL	5-30
• SOS	5-30
• SOS Test.....	5-30
System status icons	5-30
Bluetooth	5-30

5 Infotainment system

Signal strength	5-31
System specifications	5-31
• USB.....	5-31
• Bluetooth	5-32
Trademarks	5-33
Declaration of Conformity	5-34
• CE.....	5-34
• NCC.....	5-34
• BSMI.....	5-35
• IFETEL	5-36
• EAC.....	5-36
• TRA.....	5-36
• STB.....	5-36
• NBTC	5-37

Infotainment system

Infotainment system

* NOTICE

If you install an after market HID head lamp, your vehicle's audio and electronic device may malfunction.

* If your vehicle is equipped with Infotainment system, refer to a separately supplied manual for detailed information.

Antenna

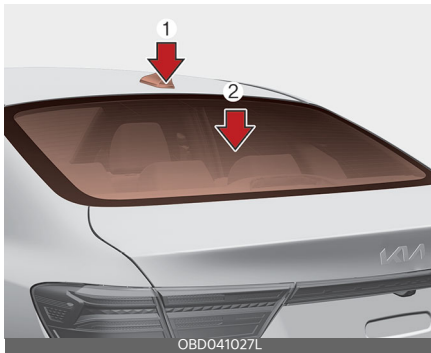

1. Shark fin antenna (1, if equipped)
The shark fin antenna receives transmitted data. (for example : GPS)
2. Glass antenna (2, if equipped)
Your vehicle uses a glass antenna to receive both AM and FM signals.

* NOTICE

- To prevent damage to the rear glass antenna, never use sharp instruments or window cleaner containing abrasives to clean the window. Clean the inside surface of the rear glass window with a piece of soft cloth.
- When putting a sticker on the inside surface of the rear window, be careful

- not to damage to the rear glass antenna.
- Avoid adding metallic coatings such as Ni, Cd, etc.
- These can degrade the receiving AM and FM broadcast signals.
- Do not put sharp instruments nearby the rear glass antenna.
- Tinted rear window may affect the proper functioning of the antenna.

Micro pole antenna



Your car uses a micro pole antenna to receive broadcast signal. The antenna pole is a removable type. To remove the antenna pole, turn it counterclockwise. To install the antenna, turn it clockwise.

⚠ CAUTION

- #### Micro pole antenna
- Before entering a place with a low height clearance or a car wash, remove surely the antenna by rotating it counterclockwise. If not, the antenna may be damaged.
 - When reinstalling your antenna, it is important that it is fully tightened and adjusted to the upright position. But it could be folded or removed when

parking the vehicle or when loading cargo on the roof rack.

- When cargo is loaded on the roof rack, do not place the cargo near the antenna pole to ensure proper reception.

USB port

You can use the USB port to plug in a USB.

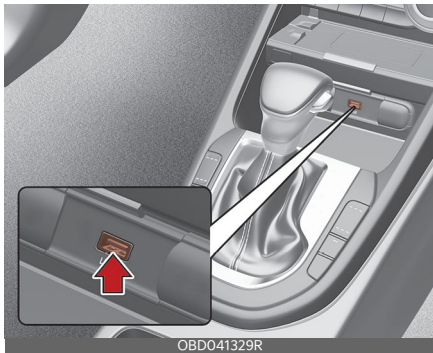

How vehicle radio works

FM reception

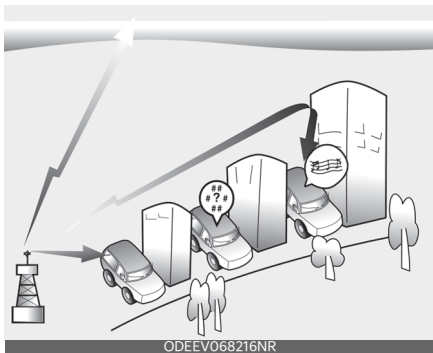

AM and FM radio signals are broadcast from transmitter towers located around your city. They are intercepted by the radio antenna on your vehicle. This sig-

nal is then processed by the radio and sent to your vehicle speakers.

However, in some cases the signal coming to your vehicle may not be strong and clear.

This can be due to factors, such as the distance from the radio station, closeness of other strong radio stations or the presence of buildings, bridges or other large obstructions in the area.

AM reception

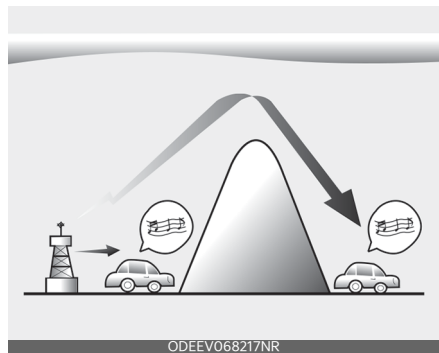

AM broadcasts can be received at greater distances than FM broadcasts. This is because AM radio waves are transmitted at low frequencies. These long distance, low frequency radio waves can follow the curvature of the earth rather than travelling straight. In addition, they curve around obstructions resulting in better signal coverage.

FM radio station

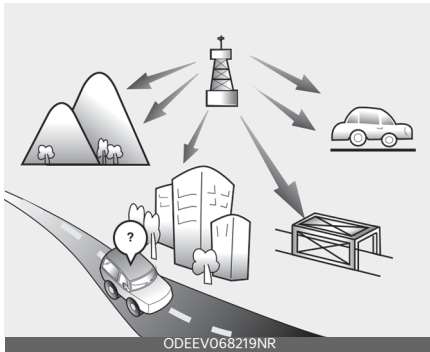

FM broadcasts are transmitted at high frequencies and do not bend to follow the earth's surface. Because of this, FM broadcasts generally begin to fade within short distances from the station. Also, FM signals are easily affected by buildings, mountains, and obstructions. This can lead to undesirable or unpleasant listening conditions which might lead you to believe a problem exists with your radio.

The following conditions are normal and do not indicate radio trouble:

- Fading - As your vehicle moves away from the radio station, the signal will weaken and sound will begin to fade. When this occurs, we suggest that you select another station with a stronger signal.

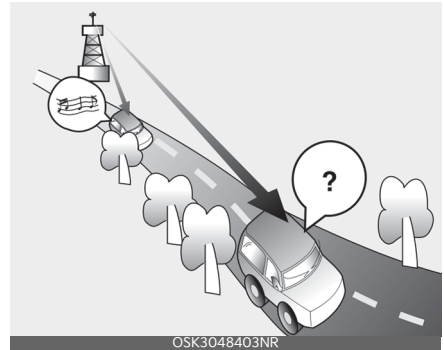

- Flutter/Static - Weak FM signals or large obstructions between the transmitter and your radio can disturb the signal causing static or fluttering noises to occur. Reducing the treble level may lessen this effect until the disturbance clears.
- Station Swapping - As an FM signal weakens, another more powerful signal near the same frequency may begin to play. This is because your radio is designed to lock onto the clearest signal. If this occurs, select another station with a stronger signal.

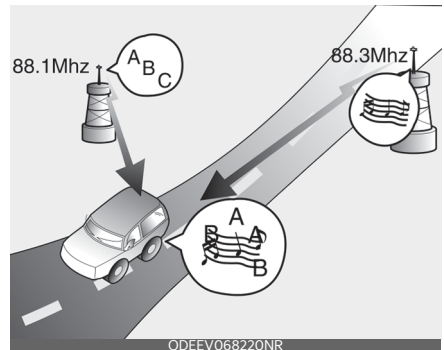

- Multi-Path Cancellation - Radio signals being received from several directions can cause distortion or fluttering. This can be caused by a direct and reflected signal from the same

station, or by signals from two stations with close frequencies. If this occurs, select another station until the condition has passed.

Using a mobile phone or a two-way radio

When a mobile phone is used inside the vehicle, noise may be produced from the audio system. This does not mean that something is wrong with the audio equipment. In such a case, try to operate mobile devices as far from the audio equipment as possible.

CAUTION

When using a communication system such as a mobile phone or a radio set inside the vehicle, a separate external antenna must be fitted. When a mobile phone or a radio set is used with only the internal antenna, it may interfere with the vehicle's electrical system and adversely affect the safe operation of the vehicle.

WARNING

Cell phone use

Do not use a mobile phone whilst driving. Stop at a safe location to use a mobile phone.

Audio (Without Touch Screen)

System layout - control panel



(With Bluetooth® Wireless Technology)

* The system's actual appearance and layout may differ depending on the vehicle model and specification.

1. SEEK/TRACK button

- Change the station/track/file.
- Whilst listening to the radio, press and hold to search for a station.
- Whilst playing media, press and hold to rewind or fast forward (except for Bluetooth audio mode).

2. PHONE button

- Press to start connecting a mobile phone via Bluetooth.
- After a Bluetooth phone connection is made, press to access the Bluetooth phone menu.

3. RADIO button

- Press to display the radio mode selection window.
- When the mode selection window displays, turn the [TUNE] knob to select the desired mode and then press the knob.

When the Mode popup is not selected in [MENU] ► Mode popup, press the [RADIO] button on the control panel to change the mode. Each time you press the [RADIO] button on the control panel, the mode switches to radio FM ► AM in order.

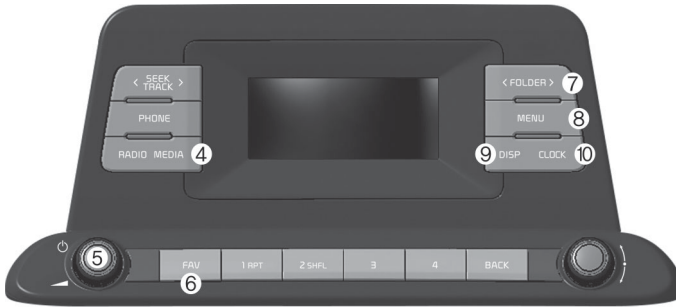

(With Bluetooth® Wireless Technology)

* The system’s actual appearance and layout may differ depending on the vehicle model and specification.

4. MEDIA button

- Press to display the media mode selection window.
- When the mode selection window displays, turn the [TUNE] knob to select the desired mode and then press the knob.

When the Mode popup is not selected in [MENU] ► Mode popup, press the [MEDIA] button on the control panel to change the mode.

Each time you press the [MEDIA] button on the control panel, the mode switches to media USB ► Bluetooth audio in order.

5. POWER button/VOLUME knob

- Press to turn the system on or off.
- Turn to the left or right to adjust the system sound volume.

6. FAV button

- Whilst listening to the radio, press to move to next page of the preset list.

7. FOLDER button

- In the USB mode, press to access the folder list.

8. MENU button

- Press to access the menu screen for the current mode.

9. DISP button

- Turn the display on or off.
- Each time you press the button, the screen will turn on and off.

10. CLOCK button

- Press to access the clock setting screen.

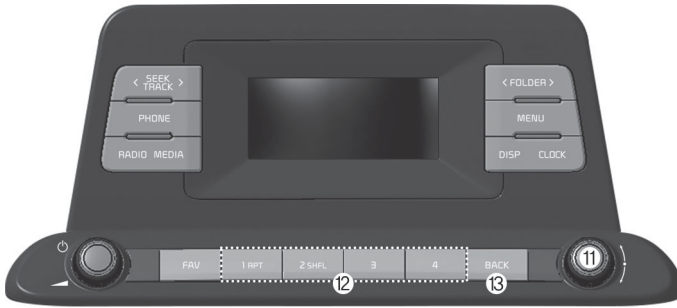

(With Bluetooth® Wireless Technology)

* The system’s actual appearance and layout may differ depending on the vehicle model and specification.

11.TUNE knob/FILE knob/ENTER button

- Whilst listening to the radio, turn to adjust the frequency.
- Whilst playing media, turn to search for a track/file (except for Bluetooth audio mode).
- Whilst searching by turning the knob, press to select the current track/file (except for the Bluetooth audio mode).

12.Number buttons (1 RPT~ 4)

- Whilst listening to the radio, press to listen to a saved radio station.
- Whilst listening to the radio, press and hold to save the current radio station to the preset.
- In the USB/Bluetooth audio modes, press the [1 RPT] button to change the repeat play mode. Press the [2 SHFL] button to change the shuffle play mode.

13.BACK button

- Press the [BACK] button to return to the previous screen (except for the radio preset list).

System layout - steering wheel remote control

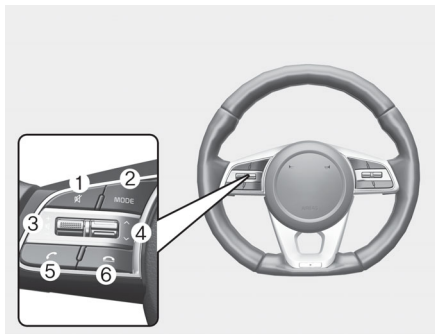

(Bluetooth® equipped model)

* The system's actual appearance and layout may differ depending on the vehicle model and specification.

1. MUTE button

- Press to mute or unmute the system.
- During a call, press to mute or unmute the microphone.
- Whilst playing media, press to pause or resume playback. (if equipped)

2. MODE button

- Press to switch between radio and media modes.
- Press and hold to turn the system on or off.

3. Volume lever

- Push up or down to adjust the volume.

4. Up/Down lever

- Change the station/track/file.
- Whilst listening to the radio, push to listen to the previous/next saved radio station.
- Whilst listening to the radio, push and hold to search for a station.

- Whilst playing media, push and hold to rewind or fast forward (except for Bluetooth audio mode).

5. Call/Answer button

- Press to start connecting a mobile phone via Bluetooth.
- After a Bluetooth phone connection is made, press to access your call history. Press and hold to dial the most recent phone number. When a call comes in, press to answer the call.
- During a call, press to switch between the active call and the held call. Press and hold to switch the call between the system and the mobile phone.

6. Call end button

- When a call comes in, reject the call.
- During a call, end the call.

WARNING

About driving

- Do not operate the system whilst driving. Driving whilst distracted may result in a loss of vehicle control, potentially leading to an accident, severe personal injury, or death. The driver's primary responsibility is the safe and legal operation of a vehicle, and any handheld devices, equipment, or vehicle systems which divert the driver's attention from this responsibility should never be used during operation of the vehicle.
- Avoid watching the screen whilst driving. Driving whilst distracted may lead to a traffic accident. Stop your vehicle in a safe location before using functions that require multiple operations.
- Stop your vehicle first before using your mobile phone. Using a mobile phone whilst driving may lead to a traffic accident. If necessary, use the

Bluetooth Handsfree feature to make calls and keep the call as short as possible.

- Keep the volume low enough to hear external sounds. Driving without the ability to hear external sounds may lead to a traffic accident. Listening to a loud volume for a long time may cause hearing damage.

WARNING

About handling the system

- Do not disassemble or modify the system. Doing so may result in an accident, fire, or electric shock.
- Do not allow liquids or foreign substances to enter the system. Liquids or foreign substances may cause noxious fumes, a fire, or a system malfunction.
- Stop using the system if it malfunctions, such as no audio output or display. If you continue using the system when it is malfunctioning, it may lead to a fire, electric shock, or system failure.
- Do not touch the antenna during thunder or lightning because such an act may cause electric shock.

CAUTION

About operating the system

- Use the system with the engine running. Using the system for a long time when the engine is stopped may discharge the battery.
- Do not install unapproved products. Using unapproved products may cause an error whilst using the system. System errors caused by install-

ing unapproved products are not covered under the warranty.

CAUTION

About handling the system

- Do not apply excessive force to the system. Excessive pressure on the screen may damage the LCD panel or the touch panel.
- When cleaning the screen or button panel, make sure to stop the engine and use a soft, dry cloth. Wiping the screen or buttons with a rough cloth or using solvents (alcohol, benzene, paint thinner, etc.) may scratch or chemically damage the surface.
- If you attach a liquid-type air freshener to the fan louvre, the surface of the louvre may become deformed due to the flowing air.
- If you want to change the position of the installed device, please inquire with your place of purchase or service maintenance centre. Technical expertise is required to install or disassemble the device.

NOTICE

- If you experience any problems with the system, contact your place of purchase or dealer.
- Placing the infotainment system within an electromagnetic environment may result in noise interference.

Turning the system on or off

To turn on the system, start the engine.

- If you do not want to use the system whilst driving, you can turn off the system by pressing the **[POWER]** button on the control panel. To use the system again, press the **[POWER]** button again.

After you have turned off the engine, the system will automatically turn off after a whilst or as soon as you open the driver's door.

- Depending on the vehicle model or specifications, the system may turn off as soon as you turn off the engine.
- When you turn back on the system, the previous mode and settings will remain intact.

⚠ WARNING

- Some functions may be disabled for safety reasons whilst the vehicle is moving. They work only when the vehicle stops. Park your vehicle in a safe location before using any of them.
- Stop using the system if it malfunctions, such as no audio output or display. If you continue using the system when it is malfunctioning, it may lead to a fire, electric shock, or system failure.

⚠ CAUTION

You can turn on the system when the key ignition switch is placed in the "ACC" or "ON" position. Using the system for an extended period without the engine running drains the battery. If you plan on using the system for a long time, start the engine.

Turning the display on or off

To prevent glare, you can turn off the screen. The screen can be turned off only whilst the system is on.

1. On the control panel, press the **[MENU]** button.
2. When the option selection window displays, turn the **[TUNE]** knob to select **Display off**, and then press the knob.
 - To turn the screen back on, press any of the control panel buttons.

Getting to know the basic operations

You can select an item or adjust the settings by using the number buttons and the **[TUNE]** knob on the control panel.

Selecting an item

Numbered items

Press the corresponding number button.

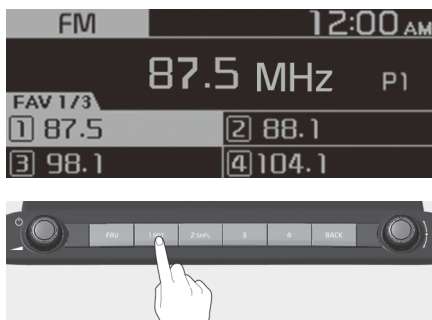

Numberless items

Turn the [TUNE] knob to select the desired item, and then press the knob to select the item.

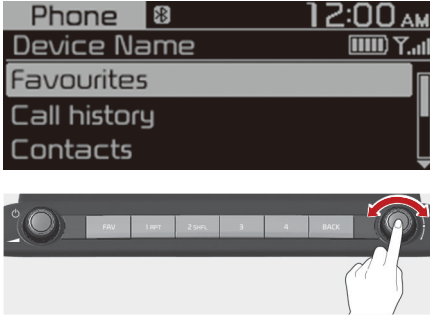

Adjusting the settings

Turn the [TUNE] knob to adjust the value, and then press the knob to save changes.

Turn the [TUNE] knob to the right to increase the value and turn the [TUNE] knob to the left to decrease the value.



Radio

Turning on the radio

1. On the control panel, press the [RADIO] button.
2. When the mode selection window displays, turn the [TUNE] knob to select the desired radio mode and then press the knob.

FM/AM Mode

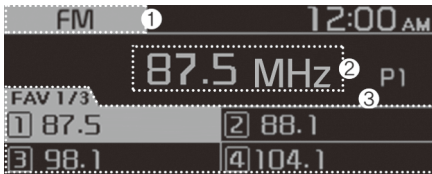

1. Current radio mode
2. Radio station information
3. Preset list

Press the [MENU] button on the control panel to access the following menu options:

- **Autostore:** Save radio stations to the preset list.
- **Scan:** The system searches for radio stations with strong radio signals and plays each radio station for about five seconds.
- **Sound settings:** You can change the settings related to sounds, such as location where sound will be concentrated and the output level for each range.
 - **Position:** Select a location where sound will be concentrated in the vehicle. Select **Fade (Fader)** or **Balance**, turn the [TUNE] knob to select the desired position, and then press the knob. To set sound to be centred in the vehicle, select **Centre**.

- **Equaliser (Tone):** Adjust the output level for each sound tone mode.
- **Sound experience:** (if equipped) select the location where sound is focused in the vehicle between the driver's seat and all other seats.
- **Speed dependent vol.:** Set the volume to be adjusted automatically according to your driving speed.

* NOTICE

- Depending on vehicle models or specifications, available options may vary.
- Depending on the system or amplifier specifications applied to your vehicle, available options may vary.

- **Mode popup:** Set to display mode selection window when the [RADIO] button is pressed on the control panel.
- **Date/Time:** You can change the date and time that are shown on the system display.
 - **Set date:** Set date to display on the system display.
 - **Set time:** Set time to display on the system display.
 - **Time format:** Select to display time in the 12 hour format or the 24 hour format.
 - **Display (Power Off):** Set to display the clock when the system power is off.
- **Language:** You can change the display language.
- **Display off:** Turn off the screen. Press any of the control panel buttons to turn back on.

FM/AM Mode (With RDS)

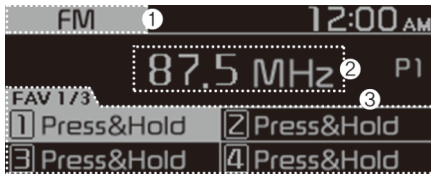

1. Current radio mode
2. Radio station information
3. Preset list

Press the [MENU] button on the control panel to access the following menu options:

- **Traffic announcement:** Activate or deactivate traffic announcements. Announcements and programmes will be received automatically if available.
- **Autostore:** Save radio stations to the preset list.
- **Scan:** The system searches for radio stations with strong radio signals and plays each option for about five seconds.
- **Sound settings:** You can change the settings related to sounds, such as location where sound will be concentrated and the output level for each range.
 - **Position:** Select a location where sound will be concentrated in the vehicle. Select **Fade (Fader)** or **Balance**, turn the [TUNE] knob to select the desired position, and then press the knob. To set sound to be centred in the vehicle, select **Centre**.
 - **Equaliser (Tone):** Adjust the output level for each sound tone mode.
 - **Speed dependent vol.:** Set the volume to be adjusted automatically according to your driving speed.

* NOTICE

- Depending on vehicle models or specifications, available options may vary.
- Depending on the system or amplifier specifications applied to your vehicle, available options may vary.

- **Mode popup:** Set to display mode selection window when the [RADIO] button is pressed on the control panel.
- **Date/Time:** You can change the date and time that are shown on the system display.
 - **Set date:** Set date to display on the system display.
 - **Set time:** Set time to display on the system display.
 - **Time format:** Select to display time in the 12 hour format or the 24 hour format.
 - **Display (Power Off):** Set to display the clock when the system power is off.
- **Language:** You can change the display language.
- **Display off:** Turn off the screen. Press any of the control panel buttons to turn back on.

DAB Mode (if equipped)



1. Current radio mode
2. Radio station information
3. Preset list

Press the [MENU] button on the control panel to access the following menu options:

- **Traffic announcement:** Activate or deactivate traffic announcements. Announcements and programmes will be received automatically if available.
- **List:** Display all available radio stations.
- **Scan:** The system searches for radio stations with strong radio signals and plays each option for about five seconds.
- **Sound settings:** You can change the settings related to sounds, such as location where sound will be concentrated and the output level for each range.
 - **Position:** Select a location where sound will be concentrated in the vehicle. Select **Fade (Fader)** or **Balance**, turn the **[TUNE]** knob to select the desired position, and then press the knob. To set sound to be centred in the vehicle, select **Centre**.
 - **Equaliser (Tone):** Adjust the output level for each sound tone mode.
 - **Speed dependent vol:** Set the volume to be adjusted automatically according to your driving speed.

* NOTICE

- Depending on vehicle models or specifications, available options may vary.
 - Depending on the system or amplifier specifications applied to your vehicle, available options may vary.
-
- **Mode popup:** Set to display mode selection window when the **[RADIO]** button is pressed on the control panel.
 - **Date/Time:** You can change the date and time that are shown on the system display.

- **Set date:** Set date to display on the system display.
- **Set time:** Set time to display on the system display.
- **Time format:** Select to display time in the 12 hour format or the 24 hour format.
- **Display (Power Off):** Set to display the clock when the system power is off.
- **Language:** You can change the display language.
- **Display off:** Turn off the screen. Press any of the control panel buttons to turn back on.

Changing the radio mode

1. On the control panel, press the **[RADIO]** button.
2. When the mode selection window displays, turn the **[TUNE]** knob to select the desired radio mode and then press the knob.
 - Each time you press the **[MODE]** button on the steering wheel, the radio mode switches to FM ► DAB ► AM in order (if any other media is not connected).

* NOTICE

When the Mode popup is not selected in **[MENU]** ► **Mode popup**, press the **[RADIO]** button on the control panel to change the radio mode.

Each time you press the **[RADIO]** button on the control panel, the radio mode switches to FM ► DAB ► AM in order (if any other media is not connected).

Scanning for available radio stations

You can listen to each radio station for a few seconds to test the reception and select the one you want.

1. From the radio screen, press the **[MENU]** button on the control panel.
2. When the option selection window displays, turn the **[TUNE]** knob to select **Scan**, and then press the knob.
 - The system searches for radio stations with strong radio signals and plays each radio station for about five seconds.
3. When you find the radio station you want to listen to, press the **[TUNE]** knob.
 - You can continue listening to the selected station.

Searching for radio stations

To search for the previous or next available radio station, press the **[< SEEK/ TRACK >]** button on the control panel.

- You can also press and hold the **[< SEEK/TRACK >]** button to search for frequencies quickly. When you release the button, a radio station with a strong signal is selected automatically.

If you know the exact frequency of the radio station you want to listen to, turn the **[TUNE]** knob on the control panel to change the frequency.

Saving radio stations

You can save your favourite radio stations and listen to them by selecting them from the preset list.

Saving the current radio station

Whilst listening to the radio, press and hold the desired number button on the control panel.

- The radio station you are listening to will be added to the selected number.
- To save the next page of the preset list, press the **[FAV]** button.

* NOTICE

- You can save up to 12 radio stations in each mode.
- If a station is already saved to the selected preset number, the station will be replaced by the station you are listening to.

Using the auto save function

You can search for radio stations in your area where there is a strong signal. The results of your search can be saved to the preset list automatically.

- From the radio screen, press the **[MENU]** button on the control panel.
- When the option selection window displays, turn the **[TUNE]** knob to select **Autostore**, and then press the knob.

Listening to saved radio stations

FM/AM Mode

1. Confirm the preset number for the radio station you want to listen to.
 - To view the next page of the preset list, press the **[FAV]** button.
2. On the control panel, press the desired number button.
 - Alternatively, push the Up/Down lever on the steering wheel to change the station.

Media player

Using the media player

You can play music stored in various media storage devices, such as USB storage devices, smartphones.

1. Connect a device to the USB port in your vehicle.
 - Playback may start immediately depending on the device that you connect to the system.
2. On the control panel, press the **[MEDIA]** button.
3. When the mode selection window displays, turn the **[TUNE]** knob to select the desired mode and then press the knob.

* NOTICE

- To start the media player, press the **[MEDIA]** button on the control panel.
- You can also change the mode by pressing the **[MODE]** button repeatedly on the steering wheel.
- Make sure to connect or disconnect external USB devices with the system power turned off.
- When the Mode popup is not selected in **[MENU] ► Mode popup**, press the **[MEDIA]** button on the control panel to change the media player.

Each time you press the **[MEDIA]** button on the control panel, the media mode switches to USB ► Bluetooth audio in order.

- Depending on vehicle models and specifications, available buttons or the appearance and layout of the USB port in your vehicle may vary.
- Do not connect a smartphone or an MP3 device to the system via multiple methods such as USB, Bluetooth simultaneously. Doing so may cause a

distorted noise or a system malfunction.

- When the equaliser function of the connected device and **Equaliser (Tone)** settings of the system are both activated, the effects may interfere with each other and may lead to sound degradation or distortion. Deactivate the device's equaliser function if possible.

Using the USB mode

You can play media files stored in portable devices, such as USB storage devices and MP3 players. Check compatible USB storage devices and file specifications before using the USB mode.

Connect your USB device to the USB port in the vehicle.

- Playback starts immediately.
- Press the **[MEDIA]** button on the control panel to display the mode selection window, turn the **[TUNE]** knob to select **USB** and then press the knob.



1. Current file number and total number of files
2. Playback time
3. Information about the song currently playing

Press the **[MENU]** button on the control panel to access the following menu options:

- **List:** Access the file list.
- **Folder list:** Access the folder list.
- **Information:** Display information about the song currently playing.

- **Sound settings:** You can change the settings related to sounds, such as location where sound will be concentrated and the output level for each range.
 - **Position:** Select a location where sound will be concentrated in the vehicle. Select **Fade (Fader)** or **Balance**, turn the [TUNE] knob to select the desired position, and then press the knob. To set sound to be centred in the vehicle, select **Centre**.
 - **Equaliser (Tone):** Adjust the output level for each sound tone mode.
 - **Speed dependent vol:** Set the volume to be adjusted automatically according to your driving speed.
- **Time format:** Select to display time in the 12 hour format or the 24 hour format.
- **Display (Power Off):** Set to display the clock when the system power is off.
- **Language:** You can change the display language.
- **Display off:** Turn off the screen. Press any of the control panel buttons to turn back on.

Rewinding/Fast forwarding

On the control panel, press and hold the [**< SEEK/TRACK >**] button.

- You can also push and hold the Up/Down lever on the steering wheel.

Restarting the current playback

On the control panel after the song has played for 2 seconds, press the [**< SEEK/TRACK >**] button.

- You can also push the Up lever on the steering wheel.

Playing the previous or next song

To play the previous song on the control panel within the first 2 seconds of the current song, press the [**< SEEK/TRACK >**] button. To play the next song, press the [**< SEEK/TRACK >**] button on the control panel.

- If more than 2 seconds of playback have elapsed, press the [**< SEEK/TRACK >**] button on the control panel twice to play the previous song.
- You can also push the Up/Down lever on the steering wheel.

* NOTICE

- Depending on vehicle models or specifications, available options may vary.
 - Depending on the system or amplifier specifications applied to your vehicle, available options may vary.
-
- **Song information (Media Display):** Select information such as **Folder/File** or **Artist/Title/Album** to display when playing MP3 files.
 - **Mode popup:** Set to display mode selection window when the [**MEDIA**] button is pressed on the control panel.
 - **Date/Time:** You can change the date and time that are shown on the system display.
 - **Set date:** Set date to display on the system display.
 - **Set time:** Set time to display on the system display.

* NOTICE

Press the [**MENU**] button on the control panel to display the mode selection window, turn the [TUNE] knob to find the

desired song and press the knob to play the song.

Playing repeatedly

On the control panel, press the [1 RPT] button. The repeat play mode changes each time you press it. The corresponding mode icon will be displayed on the screen and the playing song will be repeated.

Playing in random order

On the control panel, press the [2 SHFL] button. The shuffle play mode is activated or deactivated each time you press it. When you activate the shuffle mode, the corresponding mode icon will be displayed on the screen. When shuffle is active, the available songs will be played randomly.

Searching folders

1. On the control panel, press the [MENU] button.
2. When the option selection window displays, turn the [TUNE] knob to select the **Folder list** and then press the knob.
3. Navigate to the desired folder in the **Folder list** and then press the [TUNE] knob.
 - The first song in the selected folder will be played.

⚠ CAUTION

- Start the engine of your vehicle before connecting a USB device to your system. Starting the engine with a USB device connected to the system may damage the USB device.
 - Be careful of static electricity when connecting or disconnecting a USB device. A static discharge may cause a system malfunction.
 - Be careful not to let your body or external objects contact the USB port. Doing so may cause an accident or a system malfunction.
 - Do not connect and disconnect a USB connector repeatedly in a short time. Doing so may cause an error in the device or a system malfunction.
 - Do not use a USB device for purposes other than playing files. Using USB accessories for charging or heating may cause poor performance or a system malfunction.
-

* NOTICE

- When connecting a USB storage device, do not use an extension cable. Connect it directly to the USB port. If you use a USB hub or an extension cable, the device may not be recognized.
- Fully insert a USB connector into the USB port. Failure to do so may cause a communication error.
- When you disconnect a USB storage device, a distorted noise may occur.
- The system can play only files encoded in a standard format.
- The following types of USB devices may not be recognised or work correctly:
 - Encrypted MP3 players

- USB devices not recognised as removable disks
 - A USB device may not be recognised depending on its condition.
 - Some USB devices may be incompatible with your system.
 - Depending on the USB device's type, capacity, or the format of files, USB recognition time may be longer.
 - Image and video playback are not supported.
-

Bluetooth

Connecting Bluetooth devices

Bluetooth is a short-range wireless networking technology. Via Bluetooth, you can connect nearby mobile devices wirelessly to send and receive data between connected devices. This enables you to use your devices effectively.

To use Bluetooth, you must first connect a Bluetooth-enabled device to your system, such as a mobile phone or an MP3 player. Ensure that the device you want to connect supports Bluetooth.

WARNING

Park your vehicle in a safe location before connecting Bluetooth devices. Distracted driving can cause a traffic accident and lead to personal injury or death.

NOTICE

- On your system, you can use only Bluetooth Handsfree and Audio features. Connect a mobile device that supports both features.
- Some Bluetooth devices may cause malfunctions to the infotainment system or make interference noises. In this case, storing the device in a different location may resolve the problem.
- Depending on the connected Bluetooth device or mobile phone, some functions may not be supported.
- If the system is not stable due to a vehicle-Bluetooth device communication error, delete the paired devices and connect the Bluetooth devices again.

- If Bluetooth connection is not stable, follow these steps to try again.
 1. Deactivate Bluetooth and reactivate it on the device. Then, reconnect the device.
 2. Turn the device off and on. Then, reconnect it.
 3. Remove the battery from the device and reinstall it. Then, turn the device on and reconnect it.
 4. Unregister the Bluetooth pairing on both the system and the device and then re-register and connect them.
- The Bluetooth connection is unavailable when the device's Bluetooth function is turned off. Be sure to turn on the device's Bluetooth function.

Pairing devices with your system

For Bluetooth connections, first pair your device with your system to add it to the system's list of Bluetooth devices. You can register up to five devices.

1. From the control panel, press the **[PHONE]** button, and then select **Phone settings ► Add new device.**
 - If you are pairing a device with your system for the first time, or if there are no connected devices than you can also press the Call/Answer button on the steering wheel to initiate pairing.
2. On the Bluetooth device you want to connect, activate Bluetooth, search for your vehicle's system, and then select it.
 - Check the system's Bluetooth name, which is displayed in the new registration pop-up window on the system screen.

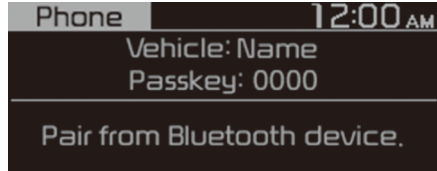

3. Enter or confirm the passkey to confirm the connection.
 - If the passkey input screen is displayed on the Bluetooth device screen, enter the passkey '0000' which is displayed on the system screen.
 - If the 6-digit passkey is displayed on the Bluetooth device screen, ensure that the Bluetooth passkey displayed on the Bluetooth device is the same as the passkey on the system screen and confirm the connection from the device.

* NOTICE

- The screen image in this manual is an example. Check your system screen for the exact vehicle name and Bluetooth device name.
- The default passkey is '0000'.
- It may take a whilst for the system to connect with the device after you permit the system to access the device. When a connection is made, the Bluetooth status icon appears at the top of the screen.
- You can change the permission settings via the mobile phone's Bluetooth settings menu. For more information, refer to your mobile phone's user guide.
- To register a new device, repeat steps 1 to 3.
- If you use the automatic Bluetooth connection function, a call may be switched to the vehicle's Handsfree

when you are taking on the phone near the vehicle whilst the vehicle's engine is on. If you do not want the system to connect with the device automatically, deactivate Bluetooth on your device.

- When a device is connected to the system via Bluetooth, the device's battery may discharge faster.

Connecting a paired device

To use a Bluetooth device on your system, connect the paired device to the system. Your system can connect with only one device at a time.

1. From the control panel, press the **[PHONE]** button, and then select **Phone settings ► Paired devices**.
 - If there is no connected device, press the Call/Answer button on the steering wheel to start pairing.
2. Turn the **[TUNE]** knob to select the device to connect, and then press the knob.
 - If another device is already connected to your system, disconnect it. Select the connected device to disconnect.

* NOTICE

- If a connection ends because a device is out of the connection range or a device error occurs, the connection will be restored automatically when the device enters the connection range or when the error is cleared.
- Depending on auto connection priority, connection to a device may take time.

Disconnecting a device

If you want to stop using a Bluetooth device or connect another device, disconnect your currently connected device.

1. From the control panel, press the **[PHONE]** button, and then select **Phone settings ► Paired devices**.
2. Turn the **[TUNE]** knob to select your currently connected device and then press the knob.
3. Press the **[1 RPT]** button to select **Yes**.

Deleting paired devices

If you no longer want a Bluetooth device paired or if you want to connect a new device when the Bluetooth device list is full, delete paired devices.

1. From the control panel, press the **[PHONE]** button, and then select **Phone settings ► Paired devices**.
2. Turn the **[TUNE]** knob to select the device to delete, and then press the knob.
3. Press the **[1 RPT]** button to select **Yes**.

* NOTICE

- When you delete a paired device, the Call history and Contacts stored in the system are also deleted.
- To re-use a deleted device, you must pair the device again.

Using a Bluetooth audio device

You can listen to music stored in the connected Bluetooth audio device via your vehicle's speakers.

1. On the control panel, press the **[MEDIA]** button.
2. When the mode selection window displays, turn the **[TUNE]** knob to select

Bluetooth audio and then press the knob.



1. Information about the song currently playing

Press the **[MENU]** button on the control panel to access the following a menu option.

- **Sound settings:** You can change the settings related to sounds, such as location where sound will be concentrated and the output level for each range.

- **Position:** Select a location where sound will be concentrated in the vehicle. Select **Fade (Fader)** or **Balance**, turn the **[TUNE]** knob to select the desired position, and then press the knob. To set sound to be centred in the vehicle, select **Centre**.
- **Equaliser (Tone):** Adjust the output level for each sound tone mode.
- **Sound experience:** (if equipped) select the location where sound is focused in the vehicle between the driver's seat and all other seats.
- **Speed dependent vol:** Set the volume to be adjusted automatically according to your driving speed.

* NOTICE

- Depending on vehicle models or specifications, available options may vary.

- Depending on the system or amplifier specifications applied to your vehicle, available options may vary.

- **Mode popup:** Set to display mode selection window when the **[MEDIA]** button is pressed on the control panel.
- **Date/Time:** You can change the date and time that are shown on the system display.
 - **Set date:** Set date to display on the system display.
 - **Set time:** Set time to display on the system display.
 - **Time format:** Select to display time in the 12 hour format or the 24 hour format.
 - **Display (Power Off):** Set to display the clock when the system power is off.
- **Language:** You can change the display language.
- **Display off:** Turn off the screen. Press any of the control panel buttons to turn back on.

Pausing/Resuming playback

To pause playback, press the **[TUNE]** knob on the control panel. To resume playback, press the **[TUNE]** knob again.

- You can also press the Mute button on the steering wheel remote control.

Playing repeatedly

On the control panel, press the **[1 RPT]** button. The repeat play mode changes each time you press it. The corresponding mode icon will be displayed on the screen and the current playing song will be repeated.

Playing in random order

On the control panel, press the **[2 SHFL]** button. The shuffle play mode is activated or deactivated each time you

press it. When you activate the shuffle mode, the corresponding mode icon will be displayed on the screen. When shuffle is active, the available songs will be played randomly.

* NOTICE

- Depending on the connected Bluetooth device, mobile phone, or the music player you are using, playback controls may differ.
- Depending on the music player you are using, streaming may not be supported.
- Depending on the connected Bluetooth device or mobile phone, some functions may not be supported.
- If a Bluetooth enabled phone is being used to play music and it receives or makes a phone call, the music will stop.
- Receiving an incoming call or making an outgoing call whilst playing Bluetooth audio may result in audio interference.
- If you use the Bluetooth phone mode whilst using Bluetooth audio, playback may not automatically resume after you end the call depending on the connected mobile phone.
- Moving the track up/down whilst playing Bluetooth audio mode may result in pop noises with some mobile phones.
- The Rewinding/Fast forwarding function is not supported in the Bluetooth audio mode.
- The playlist feature is not supported in the Bluetooth audio mode.
- If the Bluetooth device is disconnected, Bluetooth audio mode will end.

- Depending on the connected Bluetooth device or mobile phone, repeat & shuffle order features may not be supported.

Using a Bluetooth phone

You can use Bluetooth to talk on the phone hands free. View call information on the system screen, and make or receive calls safely and conveniently via the vehicle's built-in microphone and speakers.

⚠ WARNING

- Park your vehicle in a safe location before connecting Bluetooth devices. Distracted driving can cause a traffic accident and lead to personal injury or death.
- Never dial a phone number or pick up your mobile phone whilst driving. Use of a mobile phone may distract your attention, making it difficult to recognize external conditions and reducing the ability to cope with unexpected situations, which may lead to an accident. If necessary, use the Bluetooth Handsfree feature to make calls and keep the call as short as possible.

* NOTICE

- You cannot access the Phone screen if there is no connected mobile phone. To use the Bluetooth phone function, connect a mobile phone to the system.
- The Bluetooth Handsfree function may not work when you are passing out of the mobile service coverage area, such as when you are in a tunnel, underground, or in a mountainous area.

- Call quality may be degraded in the following environments:
 - The reception of the mobile phone is poor.
 - The inside of the vehicle is noisy.
 - The mobile phone is placed near metallic objects, such as a beverage can.
- Depending on the connected mobile phone, the volume and sound quality of the Bluetooth Handsfree may vary.

Making a call

If your mobile phone is connected to the system, you can make a call by selecting a name from your call history or contacts list.

1. On the control panel, press the [PHONE] button.
 - Alternatively, press the Call/Answer button on the steering wheel.
2. Select a phone number.
 - To select a phone number from your favourites list, select **Favourites**.
 - To select a phone number from your call history, select **Call history**.
 - To select a phone number from the contacts list downloaded from the connected mobile phone, select **Contacts**.
3. To end the call, press the [2 SHFL] button on the control panel.
 - Alternatively, press the Call end button on the steering wheel.

Registering the favourites list

You can more easily use Bluetooth to talk on the phone hands-free by registering phone numbers as your favourites.

1. On the Phone screen, turn the [TURN] knob on the control panel to select **Favourites**, and press the knob.
2. Select [MENU] ► **Add new favourites**.
3. Press the [1 RPT] button, and select the desired phone number.

Using the favourites list

1. From the Phone screen, turn the [TUNE] knob on the control panel to select **Favourites**, and then press the knob.
2. Turn the [TUNE] knob to select the desired contact, and then press the knob to make a phone call.

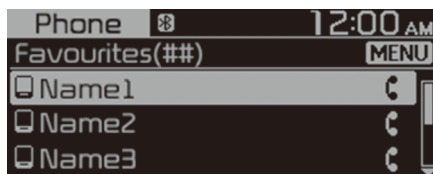

Press the [MENU] button on the control panel to access the following menu options:

- **Add new favourites:** Add a frequently used phone number to favourites.
- **Delete items:** Delete a selected favourites item.
- **Delete all:** Delete all favourites items.

* NOTICE

- You can register up to 20 favourites for each device.
- You must first download the contacts to the system to register favourites.
- The favourites list saved on the mobile phone is not downloaded to the system.
- Even if the contact information on

- the mobile phone is edited, the favourites on the system are not automatically edited. Delete and add the item to favourites again.
- When you connect a new mobile phone, your favourites set for the previous mobile phone will not be displayed, but they will remain in your system until you delete the previous phone from the device list.

Using your call history

1. From the Phone screen, turn the [TUNE] knob on the control panel to select **Call history**, and then press the knob.
2. Turn the [TUNE] knob to select the desired entry, and then press the knob to make a phone call.

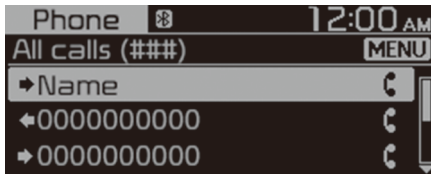

Press the [MENU] button on the control panel to access the following menu options:

- **Download:** Download your call history.
- **All calls:** View all call records.
- **Dialled calls:** View only dialled calls.
- **Received calls:** View only received calls.
- **Missed calls:** View only missed calls.

* NOTICE

- Some mobile phones may not support the download function.
- The call history is accessed only after downloading the call history when the mobile phone is connected to the system.
- Calls from restricted IDs are not saved on the call history list.
- Up to 50 call records will be downloaded per individual list.
- Call duration and time information will not be displayed on the system screen.
- Permission is required to download your call history from the mobile phone. When you attempt to download data, you may need to permit the download on the mobile phone. If the download fails, check the mobile phone screen for any notification or the mobile phone's permission setting.
- When you download your call history, any old data will be deleted.

Using the contacts list

1. From the Phone screen, turn the [TUNE] knob on the control panel to select **Contacts**, and then press the knob.
2. Turn the [TUNE] knob to select the desired group of alphanumeric characters, and then press the knob.
3. Turn the [TUNE] knob to select the desired contact, and then press the knob to make a phone call.



Press the **[MENU]** button on the control panel to access the following a menu option:

- **Download:** Download your mobile phone contacts.

*** NOTICE**

- Contacts can be viewed only when the Bluetooth device is connected.
- Only contacts in the supported format can be downloaded and displayed from the Bluetooth device. Contacts from some applications will not be included.
- Up to 2,000 contacts can be downloaded from your device.
- Some mobile phones may not support the download function.
- Depending on the system’s specifications, some of the downloaded contacts may be lost.
- Contacts stored both in the phone and in the SIM card are downloaded. With some mobile phones, contacts in the SIM card may not be downloaded.
- Special characters and figures used in the contact name may not be displayed properly.
- Permission is required to download contacts from the mobile phone. When you attempt to download data, you may need to permit the download on the mobile phone. If the download fails, check the mobile phone screen for any notification or the mobile phone’s permission setting.

- Depending on the mobile phone type or status, downloading may take longer.
- When you download your contacts, any old data will be deleted.
- You cannot edit or delete your contacts on the system.
- When you connect a new mobile phone, your contacts downloaded from the previous mobile phone will not be displayed, but they will remain in your system until you delete the previous phone from the device list.

Answering calls

When a call comes in, a notification pop-up window of the incoming call appears on the system screen.

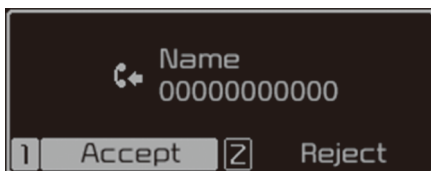

To answer the call, press the **[1 RPT]** button on the control panel.

- Alternatively, press the Call/ Answer button on the steering wheel.

To reject the call, press the **[2 SHFL]** button on the control panel.

- Alternatively, press the Call end button on the steering wheel.

*** NOTICE**

- Depending on the mobile phone type, call rejection may not be supported.
- Once your mobile phone is connected to the system, the call sound may be output through the vehicle’s speakers even after you exit the vehicle if the

phone is within the connection range. To end the connection, disconnect the device from the system or deactivate Bluetooth on the device.

Using options during a call

During active call, you will see the call screen shown below. Press a button to perform the function you want.

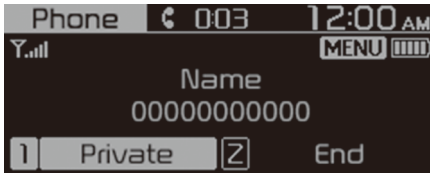

To switch the call to your mobile phone, press the [1 RPT] button on the control panel.

- Alternatively, press and hold the Call/Answer button on the steering wheel.

Press [1 RPT] again during private mode to change call from private mode to Use hands-free.

To end the call, press the [2 SHFL] button on the control panel.

- Alternatively, press the Call end button on the steering wheel.

Press the [MENU] button on the control panel to access the following a menu option:

- **Microphone Volume (Outgoing Volume):** Adjust the microphone volume or turn off the microphone so the other party cannot hear you.

* NOTICE

- If the caller information is saved in your contacts list, the caller's name and phone number will be displayed. If the caller information is not saved in your contacts list, only the caller's phone number will be displayed.

- You cannot switch to any other screen, such as the audio screen or the settings screen, during a Bluetooth call.
- Depending on the mobile phone type, call quality may vary. On some phones, your voice may be less audible to the other party.
- Depending on the mobile phone type, the phone number may not be displayed.
- Depending on the mobile phone type, the call switching function may not be supported.

ERA-GLONASS EMERGENCY CALL (if equipped)

The system ERA-GLONASS is an automatic emergency call service made in event of a traffic accident or other accidents on the roads.

SOS

Driver or passenger manually can make an emergency call in the single duty dispatch service, by pressing SOS button to call the necessary emergency services.

- Stops sound and SOS is displayed on screen.

SOS Test

You can start the ERA-GLONASS test mode by pressing the SOS TECT button.

- Stops sound and SOS TECT is displayed on screen.

* NOTICE

- For more information, refer to the "What to do in an emergency" on page 7-2.
- Depending on your region, the service may not be supported.
- Depending on your region or vehicle model, the name of the button may vary.

System status icons

Status icons appear at the top of the screen to display the current system status.

Familiarise yourself with the status icons that appear when you perform certain actions or functions and their meanings.



Bluetooth

Icon	Description
	Battery level of connected Bluetooth device
	Mobile phone or audio device connected via Bluetooth
	Bluetooth call in progress
	Microphone turned off during Bluetooth call
	Downloading call history from a mobile phone connected via Bluetooth to the system
	Downloading contacts from a mobile phone connected via Bluetooth to the system

Signal strength

Icon	Description
	Signal strength of the mobile phone connected via Bluetooth

* NOTICE

- The battery level displayed on the screen may differ from the battery level displayed on the connected device.
- The signal strength displayed on the screen may differ from the signal strength displayed on the connected mobile phone.
- Depending on vehicle models and specifications, some status icons may not be displayed.

System specifications

USB

Supported audio formats

- Audio file specification
 - WAVeform audio format
 - MPEG1/2/2.5 Audio Layer3
 - Windows Media Audio Ver 7.X/8.X
- Bit rates
 - MPEG1 (Layer3): 32/40/48/56/64/80/96/112/128/160/192/224/256/320 kbps
 - MPEG2 (Layer3): 8/16/24/32/40/48/56/64/80/96/112/128/144/160 kbps
 - MPEG2.5 (Layer3): 8/16/24/32/40/48/56/64/80/96/112/128/144/160 kbps
 - WMA (High Range): 48/64/80/96/128/160/192 kbps
- Bits Per Sample
 - WAV (PCM(Stereo)): 24 bit
 - WAV (IMA ADPCM): 4 bit
 - WAV (MS ADPCM): 4 bit
- Sampling frequency
 - MPEG1: 44100/48000/32000 Hz
 - MPEG2: 22050/24000/16000 Hz
 - MPEG2.5: 11025/12000/8000 Hz
 - WMA: 32000/44100/48000 Hz
 - WAV: 44100/48000 Hz
- Maximum length of folder/file names (Based on Unicode): 40 English or Korean characters
- Supported characters for folder/file names (Unicode support): 2,604 Korean characters, 94 alphanumeric characters, 4,888 Chinese characters in common use, 986 special characters
- Maximum number of folders: 1,000
- Maximum number of files: 5,000

*** NOTICE**

- Files that are not in a supported format may not be recognised or played, or information about them, such as the file name, may not be displayed properly.
- Only files with .mp3/.wma/.wav extensions can be recognised by the system. If the file is not in supported format, change the file format by using the latest encoding software.
- The device will not support files locked by DRM(Digital Rights Management).
- For MP3/WMA compression files and WAV file, differences in sound quality will occur depending on the bitrate. (Music files with a higher bitrate have a better sound quality.)
- Japanese or Simplified Chinese characters in folder or file names may not be displayed properly.

- drives, only files stored on the first drive will be recognised.
- If an application program is loaded on a USB storage device, the corresponding media files may not play.
- Use USB 2.0 devices for better compatibility.

Bluetooth

- Bluetooth Power Class 2: -6 to 4 dBm
- Aerial power: Max 3 mW
- Frequency range: 2400 to 2483.5 MHz
- Bluetooth patch RAM software version: 1

Supported USB storage devices

- Byte/Sector: 64 kbyte or less
- Format system: FAT12/16/32 (recommended), exFAT/NTFS

*** NOTICE**

- Operation is guaranteed only for a metal cover type USB storage device with a plug type connector.
 - USB storage devices with a plastic plug may not be recognised.
 - USB storage devices in memory card types, such as CF card or SD cards, may not be recognised.
- USB hard disk drives may not be recognised.
- When you use a large capacity USB storage device with multiple logical

Trademarks

Other trademarks and trade names are those of their respective owners.

- The Bluetooth® word mark and logos are registered trademarks owned by Bluetooth SIG, Inc. and any use of such marks by KIA is under licence.



Declaration of Conformity CE

EU Declaration of Conformity ⁽¹⁾



Product details ⁽²⁾	
Product ⁽³⁾	DIGITAL CAR AUDIO SYSTEM
Model ⁽⁴⁾	AU210DJRP, AU210DJGG, AU210DJGN, AU210DJGP, AU211DJGG, AU213DJGG, AU210DJEP, AU210DJGL, AU210DLGN, AU210DLGL, AU210DJDG, AU210DJMG, AU212DJMG
<p>We hereby declare, that the product above is in compliance with the essential requirements of the Directive 2014/53/EU by application of ⁽⁵⁾</p>	
Applied Standards ⁽⁶⁾	
Article ⁽⁷⁾ 3.2 Radio ⁽⁸⁾	EN 300 328 V2.2.2, EN 303 345-1 V1.1.1, EN 303 345-2 V1.1.1, Draft EN 303 345-3 V1.1.0 EN 303 345-4 V1.1.1 (2021-06)
Article ⁽⁷⁾ 3.1b EMC ⁽⁹⁾	EN 301 489-1 V2.2.3, EN 301 489-17 V3.2.4, EN 55032:2015, EN 55035:2017
Article ⁽⁷⁾ 3.1a Safety ⁽¹⁰⁾ , Health ⁽¹¹⁾	EN 62368-1:2020+A11:2020, EN 62368-1:2014+A11:2017, EN 62311:2008
Manufacturer ⁽¹²⁾	Representative in the EU ⁽¹³⁾
HYUNDAI MOBIS Co., Ltd. 203, Teheran-ro, Gangnam-gu, Seoul, 06141 Republic of Korea Tel: +82-31-260-2707	MOBIS Parts Europe N.V. Wilhelm-Fay-Strabe 51, Frankfurt Main, 65936, Germany Tel: +49-69-85096-5011
Notified Body ⁽¹⁴⁾	Signed By ⁽¹⁵⁾
Timco Engineering, Inc. Newberry, Florida 32669, USA 849 NW State Road 45 Notified Body Identification ⁽¹⁷⁾ 1177	11/16/2020 This declaration of conformity is issued under the sole responsibility of the manufacturer. ⁽¹⁶⁾  Seunghoon Choe Representative Hyundai MOBIS Co., Ltd.
Reference ⁽¹⁸⁾	
Additional information ⁽¹⁹⁾	
SW: 1.0, HW: 1.0	

NCC

取得審驗證明之低功率射頻器材，非經核准，公司、商號或使用者均不得擅自變更頻率、加大功率或變更原設計之特性及功能。

低功率射頻器材之使用不得影響飛航安全及干擾合法通信；經發現有干擾現象時，應立即停用，並改善至無干擾時方得繼續使用。

前述合法通信，指依電信管理法規定作業之無線電通信。低功率射頻器材須忍受合法通信或工業、科學及醫療用電波輻射性電機設備之干擾。

4.7.9.1應避免影響附近雷達系統之操作。

4.7.9.2高增益指向性天線只得應用於固定式點對點系統

BSMI

設備名稱：DIGITAL CAR AUDIO SYSTEM(Bluetooth) 型號(型式)：AU210DJDG						
單元 Unit	限用物質及其化學符號 Restricted substances and its chemical symbols					
	鉛 Lead (Pb)	汞 Mercury (Hg)	鎘 Cadmium (Cd)	六價鉻 Hexavalent chromium (Cr ⁶⁺)	多溴聯苯 Polybrominated biphenyls (PBB)	多溴二苯醚 Polybrominated diphenyl ethers (PBDE)
外殼組件	○	○	○	○	○	○
電路板組件	○	○	○	○	○	○
膠框組件	○	○	○	○	○	○
面板組件	○	○	○	○	○	○
螺絲組件	○	○	○	○	○	○
備考1. “超出0.1 wt %”及“超出0.01 wt %”係指限用物質之百分比含量超出百分比含量基準值。 Note 1 : “Exceeding 0.1 wt %” and “exceeding 0.01 wt %” indicate that the percentage content of the restricted substance exceeds the reference percentage value of presence condition.						
備考2. “○”係指該項限用物質之百分比含量未超出百分比含量基準值。 Note 2 : “○” indicates that the percentage content of the restricted substance does not exceed the percentage of reference value of presence.						
備考3. “-”係指該項限用物質為排除項目。 Note 3 : The “-” indicates that the restricted substance corresponds to the exemption.						

設備名稱：DIGITAL CAR AUDIO SYSTEM(Bluetooth) 型號(型式)：AU210DJGG						
單元 Unit	限用物質及其化學符號 Restricted substances and its chemical symbols					
	鉛 Lead (Pb)	汞 Mercury (Hg)	鎘 Cadmium (Cd)	六價鉻 Hexavalent chromium (Cr ⁶⁺)	多溴聯苯 Polybrominated biphenyls (PBB)	多溴二苯醚 Polybrominated diphenyl ethers (PBDE)
外殼組件	○	○	○	○	○	○
電路板組件	○	○	○	○	○	○
膠框組件	○	○	○	○	○	○
面板組件	○	○	○	○	○	○
螺絲組件	○	○	○	○	○	○
備考1. “超出0.1 wt %”及“超出0.01 wt %”係指限用物質之百分比含量超出百分比含量基準值。 Note 1 : “Exceeding 0.1 wt %” and “exceeding 0.01 wt %” indicate that the percentage content of the restricted substance exceeds the reference percentage value of presence condition.						
備考2. “○”係指該項限用物質之百分比含量未超出百分比含量基準值。 Note 2 : “○” indicates that the percentage content of the restricted substance does not exceed the percentage of reference value of presence.						
備考3. “-”係指該項限用物質為排除項目。 Note 3 : The “-” indicates that the restricted substance corresponds to the exemption.						

IFETEL

“La operación de este equipo está sujeta a las siguientes dos condiciones: (1) es posible que este equipo o dispositivo no cause interferencia perjudicial y (2) este equipo o dispositivo debe aceptar cualquier interferencia, incluyendo la que pueda causar su operación no deseada.”

EAC

Category	Specification
Model	AU210DJGN
Manufacturer	HYUNDAI MOBIS Co., Ltd. 203, Teheran-ro, Gangnam-gu, Seoul, 06141, Korea
Date of Manufacture	Check product for dates



TRA

OMAN-TRA
D172249
TRA/TA-R/10507/20

STB



NBTC



Before driving	6-7
• Before entering vehicle	6-7
• Necessary inspections	6-7
• Before starting.....	6-7
Key positions.....	6-8
• Illuminated ignition switch	6-8
• Ignition switch position	6-8
• Starting the engine.....	6-9
• Stopping the engine.....	6-11
ENGINE START/STOP button.....	6-11
• Illuminated ENGINE START/STOP button.....	6-11
• ENGINE START/STOP button position	6-11
• Starting the engine.....	6-14
• Stopping the petrol engine.....	6-16
Manual Transmission	6-16
• Manual Transmission operation	6-16
• Good driving practices	6-18
Automatic transmission.....	6-19
• Automatic transmission operation	6-19
• Paddle shifter.....	6-21
• Shift lock system	6-22
• Good driving practices	6-23
Dual clutch transmission (DCT)	6-25
• Dual clutch transmission operation	6-25
• DCT warning messages	6-26
• Paddle shifter.....	6-29
• Shift lock system	6-30
• Ignition key interlock system	6-31
• Good driving practices	6-31
Intelligent variable transmission (IVT).....	6-32

6 Driving your vehicle

- Intelligent Variable Transmission (IVT) operation 6-32
- IVT warning message..... 6-33
- Shift lock system 6-36
- Good driving practices 6-36
- Brake system 6-38**
 - Power brakes..... 6-38
 - Parking brake (Hand-type)..... 6-40
 - Electronic Parking Brake (EPB)..... 6-41
 - AUTO HOLD..... 6-44
 - Anti-lock brake system (ABS) 6-47
 - Electronic Stability Control (ESC)..... 6-49
 - Hill-start assist control (HAC) 6-51
 - Vehicle stability management (VSM)..... 6-52
 - ESS : Emergency Stop Signal..... 6-53
 - Good braking practices..... 6-53
- Drive mode integrated control system 6-54**
 - Drive mode 6-54
- Forward Collision-Avoidance Assist (FCA) (Front view camera only)..... 6-57**
 - Forward Collision-Avoidance Assist Settings 6-58
 - Forward Collision-Avoidance Assist Operation 6-60
 - Forward Collision-Avoidance Assist malfunction and limitations . 6-62
- Forward Collision-Avoidance Assist (FCA) (Sensor fusion).. 6-69**
 - Basic function 6-69
 - Detecting sensor 6-69
 - Forward Collision-Avoidance Assist settings..... 6-70
 - Forward Collision-Avoidance Assist operation 6-72
 - Forward Collision-Avoidance Assist malfunction and limitations . 6-74
- Lane Keeping Assist (LKA) 6-81**

• Detecting sensor.....	6-81
• Lane Keeping Assist settings	6-81
• Lane Keeping Assist operation.....	6-82
• Lane Keeping Assist malfunction and limitations.....	6-84
Blind-Spot Collision Warning (BCW)	6-86
• Detecting sensor.....	6-87
• Blind-Spot Collision Warning settings.....	6-88
• Blind-Spot Collision Warning operation	6-89
• Blind-Spot Collision Warning malfunction and limitations	6-90
Blind-Spot Collision-Avoidance Assist (BCA)	6-94
• Detecting sensor.....	6-95
• Blind-Spot Collision-Avoidance Assist settings.....	6-96
• Blind-Spot Collision-Avoidance Assist operation	6-98
• Blind-Spot Collision-Avoidance Assist malfunction and limitations .	6-101
Manual Speed Limit Assist (MSLA)	6-105
• Manual Speed Limit Assist operation.....	6-105
Driver Attention Warning (DAW)	6-107
• Driver Attention Warning settings	6-108
• Driver Attention Warning operation	6-109
• Driver Attention Warning malfunction and limitations.....	6-111
Cruise Control (CC)	6-114
• Cruise Control operation.....	6-114
Smart Cruise Control (SCC).....	6-117
• Overtaking Acceleration Assist	6-117
• Detecting sensor.....	6-117
• Smart Cruise Control settings.....	6-117
• Smart Cruise Control operating.....	6-120
• Smart Cruise Control malfunction and limitations	6-126
Lane Following Assist (LFA).....	6-131
• Detecting sensor.....	6-131

6 Driving your vehicle

- Lane Following Assist settings6-131
- Lane Following Assist operation..... 6-132
- Lane Following Assist malfunction and limitations.....6-134
- Limitations of Lane Following Assist6-134
- Rear Cross-Traffic Collision Warning (RCCW)6-134**
 - Rear Cross-Traffic Collision Warning settings 6-135
 - Rear Cross-Traffic Collision Warning6-136
 - Rear Cross-Traffic Collision Warning malfunction and limitations...
6-137
- Rear Cross-Traffic Collision-Avoidance Assist (RCCA) 6-141**
 - Rear Cross-Traffic Collision-Avoidance Assist settings 6-141
 - Rear Cross-Traffic Collision-Avoidance Assist operation.....6-143
 - Rear Cross-Traffic Collision-Avoidance Assist malfunction and limitations.....6-146
- Declaration of conformity 6-150**
 - The radio frequency components (Front Radar) complies:..... 6-150
 - The radio frequency components (Rear Corner Radar) complies:..
6-159
- Economical operation.....6-163**
- Special driving conditions 6-165**
 - Hazardous driving conditions 6-165
 - Rocking the vehicle..... 6-165
 - Smooth cornering.....6-166
 - Driving at night6-166
 - Driving in the rain6-166
 - Driving in flooded areas.....6-167
 - Driving off-road 6-167
 - Highway driving 6-167
- Winter driving 6-168**
 - Summer tyres6-168
 - Snowy or icy conditions6-168

• Use high quality ethylene glycol coolant.....	6-170
• Check battery and cables.....	6-170
• Change to "winter weight" oil if necessary.....	6-171
• Check spark plugs and ignition system.....	6-171
• To keep locks from freezing.....	6-171
• Use approved window washer anti-freeze in system.....	6-171
• Don't let your parking brake freeze.....	6-171
• Don't let ice and snow accumulate underneath.....	6-171
• Carry emergency equipment.....	6-171
• Drive your vehicle when water vapour condenses and accumulates inside the exhaust pipes.....	6-171
Trailer Towing.....	6-172
• Hitches.....	6-173
• Safety chains.....	6-174
• Trailer brakes.....	6-174
• Driving with a trailer.....	6-174
• Maintenance when trailer towing.....	6-177
• If you do decide to pull a trailer.....	6-177
Vehicle weight.....	6-180

Driving your vehicle

WARNING

ENGINE EXHAUST CAN BE DANGEROUS!

Engine exhaust fumes can be extremely dangerous. If, at any time, you smell exhaust fumes inside the vehicle, open the windows immediately.

- **Do not inhale exhaust fumes.**

Exhaust fumes contain carbon monoxide, a colourless, odourless gas that can cause unconsciousness and death by asphyxiation.

- **Be sure the exhaust system does not leak.**

The exhaust system should be checked whenever the vehicle is raised to change the oil or for any other purpose. If you hear a change in the sound of the exhaust or if you drive over something that strikes the underneath side of the vehicle, have the system checked by a professional workshop. Kia recommends to visit an authorised Kia dealer/service partner.

- **Do not run the engine in an enclosed area.**

Letting the engine idle in your garage, even with the garage door open, is a hazardous practice. Never run the engine in your garage any longer than it takes to start the engine and back the car out.

- **Avoid idling the engine for prolonged periods with people inside the car.**

If it is necessary to idle the engine for a prolonged period with people inside the car, be sure to do so only in an open area with the air intake set at "Fresh" and fan operating at one of the higher speeds so fresh air is drawn into the interior.

If you must drive with the trunk lid open because you are carrying objects that make this necessary:

1. Close all windows.
2. Open side vents.
3. Set the air intake control at "Fresh", the air flow control at "Floor" or "Face" and the fan at one of the higher speeds.

To assure proper operation of the ventilation system, be sure the ventilation air intakes located just in front of the windscreen are kept clear of snow, ice, leaves or other obstructions.

Before driving

Before entering vehicle

- Be sure that all windows, outside mirror(s), and outside lights are clean.
- Check the condition of the tyres.
- Check under the vehicle for any sign of leaks.
- Be sure there are no obstacles behind you if you intend to back up.

Necessary inspections

Fluid levels, such as engine oil, engine coolant, brake fluid, and washer fluid should be checked on a regular basis, with the exact interval depending on the fluid. Further details are provided in section 8, "Maintenance".

WARNING

Driving whilst distracted can result in a loss of vehicle control, that may lead to an accident, severe personal injury, and death. The driver's primary responsibility is in the safe and legal operation of a vehicle. Any use of handheld devices, other equipment, or vehicle systems that take the driver's eyes, attention, and focus away from the safe operation of a vehicle are not permissible by law. These should never be used during the operation of the vehicle.

Before starting

- Close and lock all doors.
- Position the seat so that all controls are easily reached.
- Adjust the inside and outside rearview mirrors.
- Be sure that all lights work.
- Check all gauges.
- Check the operation of warning lights when the ignition switch or ENGINE

START/STOP button is turned to the ON position.

- Release the parking brake and make sure the brake warning light goes out.

For safe operation, be sure you are familiar with your vehicle and its equipment.

WARNING

All passengers must be properly belted whenever the vehicle is moving. Refer to "Seat belts" on page 3-16 for more information on their proper use.

WARNING

Always check the surrounding areas near your vehicle for people, especially children, before putting a car into D (Drive) or R (Reverse).

WARNING

Driving under the influence of alcohol or drugs

Drinking and driving is dangerous. Drunk driving is the number one contributor to the highway death toll each year. Even a small amount of alcohol will affect your reflexes, perceptions and judgment. Driving whilst under the influence of drugs is as dangerous or more dangerous than driving drunk.

You are much more likely to have a serious accident if you drink or take drugs and drive.

If you are drinking or taking drugs, don't drive. Do not ride with a driver who has been drinking or taking drugs. Choose a designated driver or call a cab.

⚠ WARNING

- When you intend to park or stop the vehicle with the engine on, be careful not to depress the accelerator pedal for a long period of time. It may over-heat the engine or exhaust system and cause fire.
- When you make a sudden stop or turn the steering wheel rapidly, loose objects may drop on the floor and it could interfere with the operation of the foot pedals, possibly causing an accident. Keep all things in the vehicle safely stored.
- If you do not focus on driving, it may cause an accident. Be careful when operating what may disturb driving such as audio or heater. It is the responsibility of the driver to always drive safely.

Key positions

Illuminated ignition switch (if equipped)

Whenever a front door is opened, the ignition switch will illuminate for your convenience, provided the ignition switch is not in the ON position.

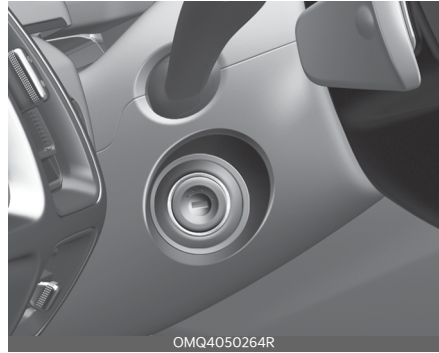

The light will go off immediately when the ignition switch is turned on. It will also go off after about 30 seconds when the door is closed.

Ignition switch position

Your vehicle is equipped with four different ignition positions.



LOCK (1)

The steering wheel locks to protect against theft. The ignition key can be removed only in the LOCK position.

ACC (Accessory) (2)

The steering wheel is unlocked and electrical accessories are operative.

*** NOTICE**

If difficulty is experienced turning the ignition switch to the ACC position, turn the key whilst turning the steering wheel right and left to release the tension.

ON (3)

The warning lights can be checked before the engine is started. This is the normal running position after the engine is started.

Do not leave the ignition switch ON if the engine is not running to prevent battery discharge.

START (4)

Turn the ignition switch to the START position to start the engine. The engine will crank until you release the key; then it returns to the ON position. The brake warning light can be checked in this position.

⚠ WARNING**Ignition switch**

- Never turn the ignition switch to LOCK or ACC whilst the vehicle is moving. This would result in loss of directional control and braking function, which could cause an accident.
- The anti-theft steering column lock is not a substitute for the parking brake.

Before leaving the driver's seat, always make sure the shift lever is engaged in 1st gear (for Manual Transmission) or P (Park) for (for Automatic Transmission), set the parking brake fully and shut the engine off. Unexpected and sudden vehicle movement may occur if these precautions are not taken.

- Never reach for the ignition switch, or any other controls through the steering wheel whilst the vehicle is in motion. The presence of your hand or arm in this area could cause a loss of vehicle control, an accident and serious bodily injury or death.
- Do not place any movable objects around the driver's seat as they may move whilst driving, interfere with the driver and lead to an accident.

Starting the engine**⚠ WARNING**

- Always wear appropriate shoes when operating your vehicle. Unsuitable shoes (high heels, ski boots, etc.) may interfere with your ability to use the brake and accelerator pedal, and the clutch. (if equipped)
- Do not start the vehicle with the accelerator pedal depressed. The vehicle can move and lead to an accident.
- Wait until the engine rpm is normal. The vehicle may suddenly move if the brake pedal is released when the rpm is high.

*** NOTICE****Kick down mechanism (if equipped)**

If your vehicle is equipped with a kick down mechanism in the accelerator pedal, it prevents you from driving at full

throttle unintentionally by making the driver require increased effort to depress the accelerator pedal. However, if you depress the pedal more than approximately 80%, the vehicle can be at full throttle and the accelerator pedal will be easier to depress. This is not a malfunction but a normal condition.

Starting the petrol engine

1. Make sure the parking brake is applied.
2. **Manual Transmission** - Depress the clutch pedal fully and shift the transmission into Neutral. Keep the clutch pedal and brake pedal depressed whilst turning the ignition switch to the start position.

Automatic Transmission / Dual

clutch transmission - Place the transmission shift lever in P (Park). Depress the brake pedal fully.

You can also start the engine when the shift level is in the N (Neutral) position.

3. Turn the ignition switch to START and hold it there until the engine starts (a maximum of 10 seconds), then release the key.

It should be started **without depressing the accelerator pedal**.

4. Do not wait for the engine to warm up whilst the vehicle remains stationary. Start driving at moderate engine speeds. (Steep accelerating and decelerating should be avoided.)

* NOTICE

If the engine does not start within 10 seconds after the preheating is completed, turn the ignition key once more to the LOCK position for 10 seconds, and then

to the ON position, in order to preheat again.

Starting and stopping the engine for turbocharger intercooler

1. Do not race or accelerate the engine immediately after starting. If the engine is cold, idle for several seconds before sufficient lubrication is ensured in the turbocharger unit.
2. After high speed or extended driving, requiring a heavy engine load, idle the engine about 1 minute before turning it off.

This idle time will allow the turbocharger to cool prior to shutting the engine off.

⚠ CAUTION

Do not turn the engine off immediately after it has been subjected to a heavy load. Doing so may cause severe damage to the engine or turbocharger unit.

⚠ CAUTION

If the engine stalls whilst you are in motion, do not attempt to move the shift lever to the P (Park) position. If traffic and road conditions permit, you may put the shift lever in the N (Neutral) position whilst the vehicle is still moving and turn the ignition switch to the START position in an attempt to restart the engine.

⚠ CAUTION

- Do not engage the starter for more than 10 seconds. If the engine stalls or fails to start, wait 5 to 10 seconds before reengaging the starter. Improper use of the starter may damage it.

- Do not turn the ignition switch to the START position with the engine running. It may damage the starter.

Stopping the engine

Manual Transmission

1. Make sure the vehicle is completely stopped and keep the clutch pedal and brake pedal depressed.
2. Shift the transmission into Neutral whilst depressing the clutch pedal and brake pedal.
3. Engage the parking brake whilst depressing the brake pedal.
4. Turn the ignition key to the LOCK position and remove it.

ENGINE START/STOP button (if equipped)

Illuminated ENGINE START/STOP button (if equipped)



Whenever the front door is opened, the ENGINE START/STOP button will illuminate for your convenience. The light will go off after about 30 seconds when the door is closed. It will also go off immediately when the theft-alarm system is armed.

ENGINE START/STOP button position

OFF

With Manual Transmission

To turn off the engine (START/RUN position) or vehicle power (ON position), stop the vehicle then press the ENGINE START/STOP button.

With Automatic Transmission / Dual Clutch Transmission

To turn off the engine (START/RUN position) or vehicle power (ON position), press the ENGINE START/STOP button with the shift lever in the P (Park) position. When you press the ENGINE

START/STOP button without the shift lever in the P (Park) position, the ENGINE START/STOP button will not change to the OFF position but to the ACC position.

Vehicles equipped with anti-theft steering column lock

The steering wheel locks when the ENGINE START/STOP button is in the OFF position to protect you against theft. It locks when the door is opened. If the steering wheel is not locked properly when you open the driver's door, the warning chime will sound. Try locking the steering wheel again. If the problem is not solved, have the system checked by a professional workshop. Kia recommends to visit an authorised Kia dealer/service partner.

In addition, if the ENGINE START/STOP button is in the OFF position after the driver's door is opened, the steering wheel will not lock and the warning chime will sound. In such a situation, close the door. Then the steering wheel will lock and the warning chime will stop.

*** NOTICE**

If the steering wheel doesn't unlock properly, the ENGINE START/STOP button will not work. Press the ENGINE START/STOP button whilst turning the steering wheel right and left to release the tension.

*** NOTICE**

You are able to turn off the engine (START/RUN) or vehicle power (ON), only when the vehicle is not in motion.

⚠ CAUTION

In an emergency situation whilst the vehicle is in motion, you are able to turn the engine off and to the ACC position by pressing the ENGINE START/STOP button for more than 2 seconds or 3 times successively within 3 seconds.

If the vehicle is still moving, to restart the vehicle:

- Manual transmission - Press the ENGINE START/STOP button with shift ever in neutral and clutch pedal depressed.
- Automatic transmission / Dual clutch transmission - Press the ENGINE START/STOP button when vehicle speed is 5 km/h or over.

ACC(Accessory)

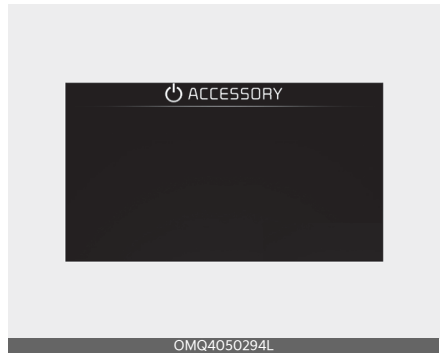

With Manual Transmission

Press the ENGINE START/STOP button when the button is in the OFF position without depressing the clutch pedal.

With Automatic Transmission / Dual Clutch Transmission

Press the ENGINE START/STOP button whilst it is in the OFF position without depressing the brake pedal.

The steering wheel unlocks and electrical accessories are operational.

If the ENGINE START/STOP button is in the ACC position for more than 1 hour, the button is turned off automatically to prevent battery discharge.

ON

With Manual Transmission

Press the ENGINE START/STOP button when the button is in the ACC position without depressing the clutch pedal.

With Automatic Transmission / Dual Clutch Transmission

Press the ENGINE START/STOP button whilst it is in the ACC position without depressing the brake pedal.

The warning lights can be checked before the engine is started. Do not leave the ENGINE START/STOP button in the ON position for a long time. The battery may discharge, because the engine is not running.

START/RUN

With Manual Transmission

To start the engine, depress the clutch pedal and brake pedal, then press the ENGINE START/STOP button with the shift lever in the N (Neutral) position.

With Automatic Transmission / Dual Clutch Transmission

To start the engine, depress the brake pedal and press the ENGINE START/STOP button with the shift lever in the P (Park) or the N (Neutral) position. For your safety, start the engine with the shift lever in the P (Park) position.

* NOTICE

If you press the ENGINE START/STOP button without depressing the clutch pedal for Manual Transmission vehicles or without depressing the brake pedal for Automatic Transmission/Dual clutch transmission vehicles, the engine will not start and the ENGINE START/STOP button changes as follow:

OFF → ACC → ON → OFF or ACC

* NOTICE

If you leave the ENGINE START/ STOP button in the ACC or ON position for a long time, the battery will discharge.

⚠ WARNING

- Never press the ENGINE START/STOP button whilst the vehicle is in motion. This would result in loss of directional control and braking function, which could cause an accident.
- The anti-theft steering column lock is not a substitute for the parking brake. Before leaving the driver's seat, always make sure the shift lever is engaged in P (Park), set the parking brake fully and shut the engine off. Unexpected and sudden vehicle movement may occur if these precautions are not taken.
- Never reach for the ENGINE START/ STOP button or any other controls

through the steering wheel whilst the vehicle is in motion. The presence of your hand or arm in the area could cause loss of vehicle control, an accident and serious bodily injury or death.

- Do not place any movable objects around the driver's seat as they may move whilst driving, interfere with the driver and lead to an accident.

Starting the engine

WARNING

- Always wear appropriate shoes when operating your vehicle. Unsuitable shoes (high heels, ski boots, etc.) may interfere with your ability to use the brake and accelerator pedal.
- Do not start the vehicle with the accelerator pedal depressed. The vehicle can move and lead to an accident.
- Wait until the engine rpm is normal. The vehicle may suddenly move if the brake pedal is released when the rpm is high.

NOTICE

Kick down mechanism

Use the kick down mechanism for maximum acceleration. Depress the accelerator pedal beyond the pressure point. The automatic transmission will shift to a lower gear depending on the engine speed.

Starting the petrol engine

1. Carry the smart key or leave it inside the vehicle.
2. Make sure the parking brake is firmly applied.

3. **Manual Transmission** - Depress the clutch pedal fully and shift the transmission into Neutral. Keep the clutch pedal and brake pedal depressed whilst starting the engine.

Automatic Transmission / Dual

Clutch Transmission - Place the transmission shift lever in P (Park). Depress the brake pedal fully.

You can also start the engine when the shift lever is in the N (Neutral) position.

4. Press the ENGINE START/STOP button.

It should be started **without depressing the accelerator pedal**.

5. Do not wait for the engine to warm up whilst the vehicle remains stationary. Start driving at moderate engine speeds. (Steep accelerating and decelerating should be avoided.)

CAUTION

Do not turn the ENGINE START/STOP button to the START position with the engine running. It may damage the starter.

Starting and stopping the engine for turbocharger intercooler

1. Do not race or accelerate the engine immediately after starting. If the engine is cold, idle for several seconds before sufficient lubrication is ensured in the turbocharger unit.
2. After high speed or extended driving, requiring a heavy engine load, idle the engine about 1 minute before turning it off. This idle time will allow the turbocharger to cool prior to shutting the engine off.

Starting the engine with smart key

- Even if the smart key is in the vehicle, if it is far away from you, the engine may not start.
- When the ENGINE START/STOP button is in the ACC position or above, if any door is opened, the system checks for the smart key. If the smart key is not in the vehicle, the “🚗” or “KEY OUT” indicator will blink or the warning “Key is not in vehicle” will illuminate on the LCD display. And if all doors are closed, the chime will sound for 5 seconds. The indicator or warning will turn off whilst the vehicle is moving. Always have the smart key with you.

⚠️ WARNING

The engine will start, only when the smart key is in the vehicle. Never allow children or any person who is unfamiliar with the vehicle touch the ENGINE START/STOP button or related parts.

⚠️ CAUTION

If the engine stalls whilst the vehicle is in motion, do not attempt to move the shift lever to the P (Park) position. If the traffic and road conditions permit, you may put the shift lever in the N (Neutral) position whilst the vehicle is still moving and press the ENGINE START/STOP button in an attempt to restart the engine.

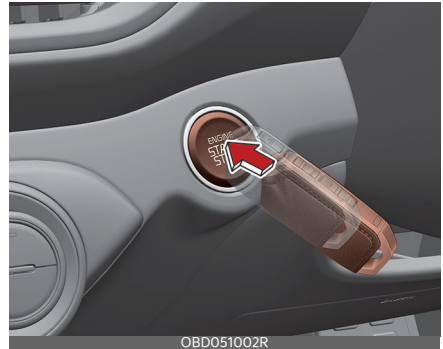

* NOTICE

- If the battery is weak or the smart key does not work correctly, you can start the engine by pressing the ENGINE START/STOP button with the smart key. The side with the lock button should contact the ENGINE START/STOP button directly. When you press the ENGINE START/STOP button directly with the smart key, the smart key should contact the button at a right angle.
- When the stop lamp fuse is blown, you can't start the engine normally. Replace the fuse with a new one. If it is not possible, you can start the engine by pressing the ENGINE START/STOP button for 10 seconds whilst it is in the ACC position. The engine can start without depressing the brake pedal. But for your safety always depress the brake pedal before starting the engine.

⚠️ CAUTION

Do not press the ENGINE START/STOP button for more than 10 seconds except when the stop lamp fuse is blown.

Do not turn the ignition switch to the START position with the engine running.

It may damage the starter.

Stopping the petrol engine

Manual Transmission

1. Make sure the vehicle is completely stopped and keep the clutch pedal and brake pedal depressed.
2. Shift the transmission into Neutral whilst depressing the clutch pedal and brake pedal.
3. Engage the parking brake whilst depressing the brake pedal.
4. Turn the ignition key to the LOCK position and remove it.

Manual Transmission (if equipped)

Manual Transmission operation

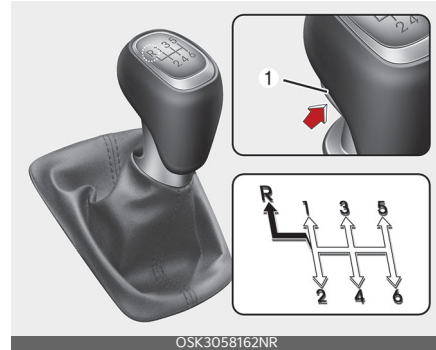

⇨ The shift lever can be moved without pushing the button (1).

➡ The button (1) should be pressed when moving the shift lever into reverse. The Manual Transmission has 6 forward gears.

This shift pattern is imprinted on the shift knob. The transmission is fully synchronized in all forward gears so shifting to either a higher or a lower gear is easily accomplished.

Depress the clutch pedal down fully whilst shifting, then release it slowly.

If your vehicle is equipped with an ignition lock switch, the engine will not start when starting the engine without depressing the clutch pedal. (if equipped)

The shift lever must be returned to the neutral position before shifting into R (Reverse).

Push the button located immediately below the shift knob and pull the gear-shift lever to the left sufficiently, and then shift into reverse (R) gear position.

Make sure the vehicle is completely stopped before shifting into R (Reverse). Never operate the engine with the tachometer (rpm) in the red zone.

⚠ CAUTION

- When downshifting from fifth gear to fourth gear, caution should be taken not to inadvertently press the shift lever sideways in such a manner that the second gear is engaged. Such a drastic downshift may cause the engine speed to increase to the point that the tachometer will enter the red-zone. Such over-revving of the engine and transmission may possibly cause engine damage.
 - Do not downshift more than 2 gears or downshift the gear when the engine is running at high speed (5,000 RPM or higher). Such a downshifting may damage the engine, clutch and the transmission.
-
- During cold weather, shifting may be difficult until the transmission lubricant is warmed up. This is normal and not harmful to the transmission.
 - If you've come to a complete stop and it's hard to shift into 1st or R (Reverse), leave the shift lever at N (Neutral) position and release the clutch. Press the clutch pedal back down, and then shift into 1st or R (Reverse) gear position.

⚠ CAUTION

- To avoid premature clutch wear and damage, do not drive with your foot resting on the clutch pedal. Also, don't use the clutch to hold the vehicle stopped on an uphill grade, whilst waiting for a traffic light, etc.

- Do not use the shift lever as a handrest during driving, as this can result in premature wear of the transmission shift forks.
- To prevent possible damage to the clutch system, do not start with the 2nd (second) gear engaged except when you start on a slippery road.

⚠ WARNING

- Before leaving the driver's seat, always set the parking brake fully and shut the engine off. Then make sure the transmission is shifted into 1st gear when the vehicle is parked on a level or uphill grade, and shifted into R (Reverse) on a downhill grade. Unexpected and sudden vehicle movement can occur if these precautions are not followed in the order identified.
- Do not use the engine brake (shifting from a high gear to lower gear) rapidly on slippery roads.
The vehicle may slip causing an accident.

Using the clutch

The clutch should be pressed all the way to the floor before shifting, then released slowly. The clutch pedal should always be fully released whilst driving. Do not rest your foot on the clutch pedal whilst driving. This can cause unnecessary wear. Do not partially engage the clutch to hold the vehicle on an incline. This causes unnecessary wear. Use the foot brake or parking brake to hold the vehicle on an incline. Do not operate the clutch pedal rapidly and repeatedly.

⚠ CAUTION

When operating the clutch pedal, press the clutch pedal down fully. If you don't press the clutch pedal fully, the clutch may be damaged or noise may occur.

⚠ WARNING**Using the clutch**

Depress the clutch pedal as far as possible. Be aware not to apply the pedal again before it returns to the normal position. If the pedal is repeatedly depressed before returning to its normal position, the clutch system might be damaged. Do not overload the vehicle. Starting or driving a vehicle in this situation generates too much frictional heat to the clutch disk which might cause damage to the clutch cover and disk. When starting the vehicle or driving backwards, releasing the clutch pedal too soon after shifting the lever might turn off the engine and lead to an accident.

Downshifting

When you must slow down in heavy traffic or whilst driving up steep hills, downshift before the engine starts to labour. Downshifting reduces the chance of stalling and gives better acceleration when you again need to increase your speed. When the vehicle is travelling down steep hills, downshifting helps maintain safe speed and prolongs brake life.

Good driving practices

- Never take the vehicle out of gear and coast down a hill. This is extremely hazardous. Always leave the vehicle in gear.

- Don't "ride" the brakes. This can cause them to overheat and malfunction. Instead, when you are driving down a long hill, shift to a lower gear. When you do this, engine braking will help slow down the vehicle.
- Slow down before shifting to a lower gear. This will help avoid over-revving the engine, which can cause damage.
- Slow down when you encounter cross winds. This gives you much better control of your vehicle.
- Be sure the vehicle is completely stopped before you attempt to shift into reverse. The transmission can be damaged if you do not.
- Exercise extreme caution when driving on a slippery surface. Be especially careful when braking, accelerating or shifting gears. On a slippery surface, an abrupt change in vehicle speed can cause the drive wheels to lose traction and the vehicle to go out of control.

⚠ WARNING

- Always buckle-up! In a collision, an unbelted occupant is significantly more likely to be seriously injured or killed than a properly belted occupant.
- Avoid high speeds when cornering or turning.
- Do not make quick steering wheel movements, such as sharp lane changes or fast, sharp turns.
- The risk of rollover is greatly increased if you lose control of your vehicle at highway speeds.
- Loss of control often occurs if two or more wheels drop off the roadway and the driver oversteers to reenter the roadway.

- In the event your vehicle leaves the roadway, do not steer sharply. Instead, slow down before pulling back into the travel lanes.
- Never exceed posted speed limits.

Automatic transmission (if equipped)

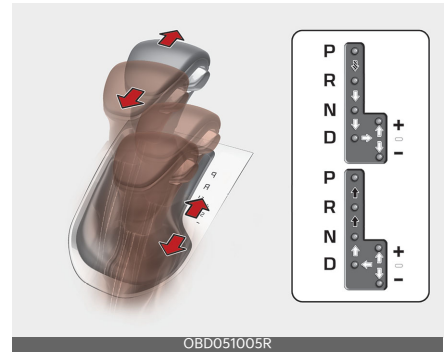

 Depress the brake pedal and the lock release button when shifting.

 Press the lock release button when shifting.

 The shift lever can be shifted freely.

Automatic transmission operation

The automatic transmission has 6 forward speeds and one reverse speed. The individual speeds are selected automatically, depending on the position of the shift lever.

* NOTICE

The first few shifts on a new vehicle, if the battery has been disconnected, may be somewhat abrupt. This is a normal condition, and the shifting sequence will adjust after shifts are cycled a few times by the TCM (Transmission Control Module) or PCM (Powertrain Control Module).

For smooth operation, depress the brake pedal when shifting from N (Neutral) to a forward or reverse gear.

⚠ WARNING**Automatic transmission**

- Always check the surrounding areas near your vehicle for people, especially children, before shifting a vehicle into D (Drive) or R (Reverse).
- Before leaving the driver's seat, always make sure the shift lever is in the P (Park) position; then set the parking brake fully and shut the engine off. Unexpected and sudden vehicle movement can occur if these precautions are not followed in the order identified.
- Do not use the engine brake (shifting from a high gear to lower gear) rapidly on slippery roads.
The vehicle may slip causing an accident.

⚠ CAUTION

- To avoid damage to your transmission, do not accelerate the engine in R (Reverse) or any forward gear position with the brakes on.
- When stopped on an incline, do not hold the vehicle stationary with engine power. Use the service brake or the parking brake.
- Do not shift from N (Neutral) or P (Park) into D (Drive), or R (Reverse) when the engine is above idle speed.

Transmission ranges

The indicator in the instrument cluster displays the shift lever position when the ignition switch or ENGINE START/STOP is in the ON position.

P (Park)

Always come to a complete stop before shifting into P (Park). This position locks the transmission and prevents the front wheels from rotating.

⚠ WARNING

- Shifting into P (Park) whilst the vehicle is in motion will cause the drive wheels to lock which will cause you to lose control of the vehicle.
- Do not use the P (Park) position in place of the parking brake. Always make sure the shift lever is latched in the P (Park) position and set the parking brake fully.
- Never leave a child unattended in a vehicle.

⚠ CAUTION

The transmission may be damaged if you shift into P (Park) whilst the vehicle is in motion.

R (Reverse)

Use this position to drive the vehicle backward.

⚠ CAUTION

Always come to a complete stop before shifting into or out of R (Reverse); you may damage the transmission if you shift into R whilst the vehicle is in motion, except as explained in "Rocking the vehicle" on page 6-191.

N (Neutral)

The wheels and transmission are not engaged. The vehicle will roll freely even

on the slightest incline unless the parking brake or service brakes are applied.

⚠ WARNING

Do not drive with the shift lever in N (Neutral).

The engine brake will not work and lead to an accident.

D (Drive)

This is the normal forward driving position. The transmission will automatically shift through a 6-gear sequence, providing the best fuel economy and power.

For extra power when passing another vehicle or climbing grades, depress the accelerator pedal fully, at which time the transmission will automatically downshift to the next lower gear.

*** NOTICE**

Always come to a complete stop before shifting into D (Drive).

Manual mode



Whether the vehicle is stationary or in motion, manual mode is selected by pushing the shift lever from the D (Drive) position into the manual gate. To return to D (Drive) range operation, push the shift lever back into the main gate.

In manual mode, moving the shift lever backwards and forwards will allow you to make gearshifts rapidly. In contrast to a manual transmission, the manual mode allows gearshifts with the accelerator pedal depressed.

- Up (+): Push the lever forward once to shift up one gear.
- Down (-): Pull the lever backwards once to shift down one gear.

*** NOTICE**

- Only the 6 forward gears can be selected. To reverse or park the vehicle, move the shift lever to the R (Reverse) or P (Park) position as required.
- Downshifts are made automatically when the vehicle slows down. When the vehicle stops, 1st gear is automatically selected.
- When the engine rpm approaches the red zone shift points are varied to upshift automatically.
- To maintain the required levels of vehicle performance and safety, the system may not execute certain gearshifts when the shift lever is operated.
- When driving on a slippery road, push the shift lever forward into the +(up) position. This causes the transmission to shift into the 2nd gear which is better for smooth driving on a slippery road. Push the shift lever to the -(down) side to shift back to the 1st gear.

Paddle shifter (if equipped)

The paddle shifter is available when the shift lever is in the D position or the manual mode.

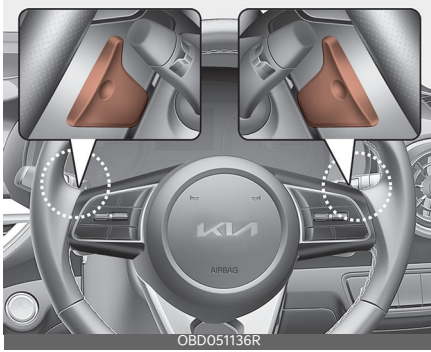

With the shift lever in the D position

The paddle shifter can operate when the vehicle speed is more than 10 km/h. Pull the [+] or [-] paddle shifter once to shift up or down one gear and the system changes from automatic mode to manual mode. If the vehicle speed is lower than 9 km/h, if you depress the accelerator pedal gently for more than 6 seconds or if you shift the shift lever from D to manual mode and shift it from manual mode to D again or pull the [+] paddle shifter for more than 1 second, the system change from manual mode to automatic mode.

With the shift lever in the manual mode

Pull the [+] or [-] paddle shifter once to shift up or down one gear.

* NOTICE

If you pull the [+] and [-] paddle shifters at the same time, you can't shift the gear.

Shift lock system (if equipped)

For your safety, the automatic transmission has a shift lock system which pre-

vents shifting the transmission from P (Park) into R (Reverse) unless the brake pedal is depressed.

To shift the transmission from P (Park) into R (Reverse):

1. Depress and hold the brake pedal.
2. Start the engine or turn the ignition switch to the ON position.
3. Move the shift lever.

If the brake pedal is repeatedly depressed and released with the shift lever in the P (Park) position, a chattering noise near the shift lever may be heard. This is a normal condition.

⚠ WARNING

Always fully depress the brake pedal before and whilst shifting out of the P (Park) position into another position to avoid inadvertent motion of the vehicle which could injure persons in or around the vehicle.

Shift-lock override

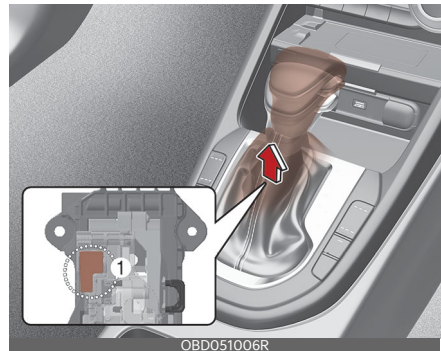

If the shift lever cannot be moved from the P (Park) position into R (Reverse) position with the brake pedal depressed, continue depressing the brake, and then do the following:

1. Remove the shift lever boots from the console by using a plastic trim tool.
2. After removing the boots, press and hold the button (1) on the left front side with a pointed tool and change it to the N (Neutral) position.

If the shift lever does not move even after performing this procedure, have the system inspected by a professional workshop. Kia recommends to visit an authorised Kia dealer/service partner.

CAUTION

- Be careful not to damage the cover when removing the shift lever boots.
- Be sure that the vehicle is in flat level ground when releasing the shift-lock.

Ignition key interlock system (if equipped)

The ignition key cannot be removed unless the shift lever is in the P (Park) position.

Good driving practices

- Never move the shift lever from P (Park) or N (Neutral) to any other position with the accelerator pedal depressed.
- Never move the shift lever into P (Park) when the vehicle is in motion.
- Be sure the vehicle is completely stopped before you attempt to shift into R (Reverse) or D (Drive).
- Never take the vehicle out of gear and coast down a hill. This may be extremely hazardous. Always leave the vehicle in gear when moving.
- Do not "ride" the brakes. This can cause them to overheat and malfunction. Instead, when you are driving down a long hill, slow down and shift

to a lower gear. When you do this, engine braking will help slow down the vehicle.

- Slow down before shifting to a lower gear. Otherwise, the lower gear may not be engaged.
- Always use the parking brake. Do not depend on placing the transmission in P (Park) to keep the vehicle from moving.
- Exercise extreme caution when driving on a slippery surface. Be especially careful when braking, accelerating or shifting gears. On a slippery surface, an abrupt change in vehicle speed can cause the drive wheels to lose traction and the vehicle to go out of control.
- Optimum vehicle performance and economy is obtained by smoothly depressing and releasing the accelerator pedal.

WARNING

- When driving uphill or downhill, always shift to D (Drive) for driving forward or shift to R (Reverse) for driving backwards, and check the gear position indicated on the cluster before driving.
Driving in the opposite direction of the selected gear can lead to a dangerous situation by shutting off the engine and affecting the braking performance.
- Always buckle-up! In a collision, an unbelted occupant is significantly more likely to be seriously injured or killed than a properly belted occupant.
- Avoid high speeds when cornering or turning.

- Do not make quick steering wheel movements, such as sharp lane changes or fast, sharp turns.
- The risk of rollover is greatly increased if you lose control of your vehicle at highway speeds.
- Loss of control often occurs if two or more wheels drop off the roadway and the driver oversteers to reenter the roadway.
- In the event your vehicle leaves the roadway, do not steer sharply. Instead, slow down before pulling back into the travel lanes.
- Never exceed posted speed limits.

help prevent the vehicle from rolling backwards.

WARNING

If your vehicle becomes stuck in snow, mud, sand, etc., then you may attempt to rock the vehicle free by moving it forward and backward. Do not attempt this procedure if people or objects are anywhere near the vehicle. During the rocking operation the vehicle may suddenly move forward or backward as it becomes unstuck, causing injury or damage to nearby people or objects.

Moving up a steep grade from a standing start

To move up a steep grade from a standing start, depress the brake pedal, shift the shift lever to D (Drive). Select the appropriate gear depending on load weight and steepness of the grade, and release the parking brake. Depress the accelerator gradually whilst releasing the service brakes.

When accelerating from a stop on a steep hill, the vehicle may have a tendency to roll backwards. Shifting the shift lever into 2 (Second Gear) will

Dual clutch transmission (DCT) (if equipped)

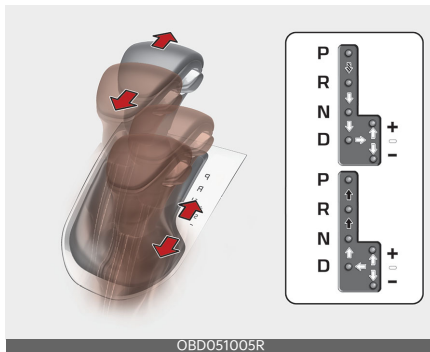

➡ Depress the brake pedal and the lock release button when shifting.

➡ Press the lock release button when shifting.

➡ The shift lever can be shifted freely.

* To move the shift lever from/to P (Parking) or between R (Reverse) and D (Drive), you must depress the brake pedal for the vehicle to stand still.

Dual clutch transmission operation

The dual clutch transmission has 7 forward speeds and one reverse speed.

The individual speeds are selected automatically in the D (Drive) position.

⚠ WARNING

To reduce the risk of serious injury or death:

- ALWAYS check the surrounding areas near your vehicle for people, especially children, before shifting a vehicle into D (Drive) or R (Reverse).
- Before leaving the driver's seat, always make sure the shift lever is in the P (Park) position, then set the

parking brake, and place the ignition switch or ENGINE START/STOP button in the LOCK/OFF position. Unexpected and sudden vehicle movement can occur if these precautions are not followed.

- Do not use engine braking (shifting from a high gear to lower gear) rapidly on slippery roads. The vehicle may slip causing an accident.
-
- The Dual Clutch Transmission gives the driving feel of a manual transmission, yet provides the ease of a fully automatic transmission. Unlike a traditional automatic transmission, the gear shifting can be felt (and heard) on the dual clutch transmission
 - Think of it as an automatically shifting manual transmission.
 - Shift into Drive range and get fully automatic shifting, similar to a conventional automatic transmission.
 - Dual clutch transmission adopts dry-type dual clutch, which is different from torque converter of automatic transmission, and shows better acceleration performance during driving. But, initial launch might be little bit slower than automatic transmission.
 - The dry-type clutch transfers torque and provides a direct driving feeling which may feel different from a conventional automatic transmission with a torque converter. This may be more noticeable when starting from a stop or low vehicle speed.
 - When rapidly accelerating at low vehicle speed, engine could rev at high rpm depending on vehicle drive condition.

- For smooth launch uphill, press down the accelerator pedal smoothly depending on the current conditions.
- If you release your foot from the accelerator pedal at low vehicle speed, you may feel strong engine brake, which is similar to manual transmission.
- When driving downhill, you may use manual mode to downshift to a lower gear in order to control your speed without using the brake pedal excessively.
- When you turn the engine on and off, you may hear clicking sounds as the system goes through a self test. This is a normal sound for the Dual Clutch Transmission.

⚠ WARNING

Due to transmission failure, the vehicle may not move and the position indicator (D, R) will blink on the cluster. In this case, have the system checked by a professional workshop. Kia recommends to visit an authorised Kia dealer/service partner.

DCT warning messages

This warning message is displayed when vehicle is driving slowly on a grade and the vehicle detects that the brake pedal is not applied.

Steep grade

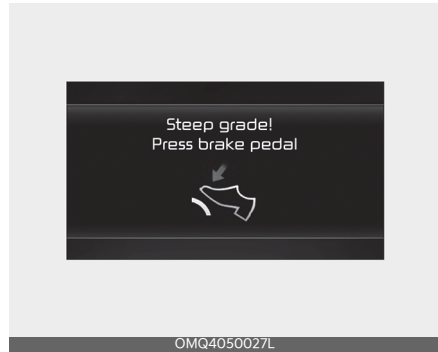

Driving up hills or on steep grades:

- To hold the vehicle on an incline use the foot brake or the parking brake.
- When in stop-and-go traffic on an incline, keep some distance ahead before moving the vehicle forward. Then hold the vehicle on the incline with the foot brake.
- If the vehicle is held on a hill by applying the accelerator pedal or by creeping with brake pedal disengaged, the clutch and transmission may overheat which can result in damage. At this time, a warning message will appear on the LCD display.
- If the LCD warning is active, the foot brake must be applied.
- Ignoring the warnings can lead to damage to the transmission.

Transmission high temperature



- Under certain conditions, such as repeated stop-and-go launches on steep grades, sudden take off or acceleration, or other harsh driving conditions, the transmission clutch temperatures will increase excessively. Finally the clutch in transmission could be overheated.
- When the clutch is overheated, the safe protection mode engages and the gear position indicator on the cluster blinks with a chime. At this time, "Transmission temp. is high! Stop safely" warning message will appear on the LCD display and driving may not be smooth.
- If this occurs, pull over to a safe location, stop the vehicle with the engine running, apply the brakes and shift the vehicle to P (Park), and allow the transmission to cool.
- If you ignore this warning, the driving condition may become worse. You may experience abrupt shifts, frequent shifts, or jerkiness. To return to the normal driving condition, stop the vehicle and apply the foot brake or shift into P (Park).

Then allow the transmission to cool for a few minutes with engine on, before driving off.

- When possible, drive the vehicle smoothly.

Transmission overheated



- If the vehicle continues to be driven and the clutch temperatures reach the maximum temperature limit, the "Transmission Hot! Park with engine on" warning will be displayed. When this occurs the clutch is disabled until the clutch cools to normal temperatures.
- The warning will display a time to wait for the transmission to cool.
- If this occurs, pull over to a safe location, stop the vehicle with the engine running, apply the brakes and shift the vehicle to P (Park), and allow the transmission to cool.
- When the message "Trans cooled down. Resume driving. appears you can continue to drive your vehicle.
- When possible, drive the vehicle smoothly.

If any of the warning messages in the LCD display continue to blink, for your safety, We recommend have the system checked by a professional workshop. Kia recommends to visit an authorised Kia dealer/service partner.

Transmission ranges

The indicator in the instrument cluster displays the shift lever position when the ignition switch or ENGINE START/STOP is in the ON position.

P (Park)

Always come to a complete stop before shifting into P (Park).

To shift from P (Park), you must depress firmly on the brake pedal and make sure your foot is off the accelerator pedal.

The shift lever must be in P (Park) before turning the engine off.

WARNING

- Shifting into P (Park) whilst the vehicle is in motion may cause you to lose control of the vehicle.
- After the vehicle has stopped, always make sure the shift lever is in P (Park), apply the parking brake, and turn the engine off.
- Do not use the P (Park) position in place of the parking brake.

R (Reverse)

Use this position to drive the vehicle backward.

CAUTION

Always come to a complete stop before shifting into or out of R (Reverse); you may damage the transmission if you shift into R (Reverse) whilst the vehicle is in motion.

N (Neutral)

The wheels and transmission are not engaged.

WARNING

Do not shift into gear unless your foot is firmly on the brake pedal. Shifting into gear when the engine is running at high speed can cause the vehicle to move very rapidly. You could lose control of the vehicle and hit people or objects.

WARNING

Do not drive with the shift lever in N (Neutral).

The engine brake will not work and lead to an accident.

D (Drive)

This is the normal driving position. The transmission will automatically shift through a 7 gear sequence, providing the best fuel economy and power.

For extra power when passing another vehicle or driving uphill depress the accelerator pedal further until you feel the transmission downshift to a lower gear.

To stop the vehicle during driving, please press brake pedal fully to prevent unintended movement.

Manual mode



Whether the vehicle is stationary or in motion, manual mode is selected by pushing the shift lever from the D (Drive) position into the manual gate. To return to D (Drive) range operation, push the shift lever back into the main gate.

In manual mode, moving the shift lever backwards and forwards will allow you to select the desired range of gears for the current driving conditions.

- Up (+): Push the lever forward once to shift up one gear.
- Down (-): Pull the lever backwards once to shift down one gear.

* NOTICE

- Only the 7 forward gears can be selected. To reverse or park the vehicle, move the shift lever to the R (Reverse) or P (Park) position as required.
- Downshifts are made automatically when the vehicle slows down. When the vehicle stops, 1st gear is automatically selected.
- When the engine rpm approaches the red zone shift points are varied to upshift automatically.
- If the driver presses the lever to + (Up) or - (Down) position, the transmission may not make the requested gear change if the next gear is outside of the allowable engine rpm range. The driver must execute upshifts in accordance with road conditions, taking care to keep the engine rpms below the red zone.

Paddle shifter (if equipped)

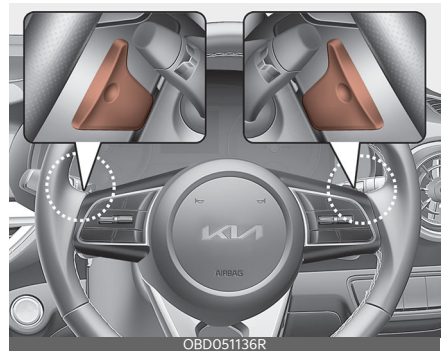

The paddle shifter is available when the shifter lever is the D (Drive) position or the manual mode.

With the shift lever in the D position

The paddle shifter will operate when the vehicle speed is more than 3 km/h. Pull the [+] or [-] paddle shifter once to shift up or down one gear and the system changes from automatic mode to manual mode. When the vehicle speed is lower than 3 km/h, if you depress the accelerator pedal gently for more than 6 seconds or if you shift the shift lever from D (Drive) to manual mode and shift it from manual mode to D (Drive) again or pull the [+] paddle shifter for more than 1 second, the system changes from manual mode to automatic mode.

With the shift lever in the manual mode

Pull the [+] or [-] paddle shifter once to shift up or down one gear.

* NOTICE

If you pull the [+] and [-] paddle shifters at the same time, you cannot shift the gear.

Shift lock system (if equipped)

For your safety, the Dual clutch transmission has a shift lock system which prevents shifting the transmission from P (Park) into R (Reverse) unless the brake pedal is depressed.

To shift the transmission from P (Park) into R (Reverse):

1. Pull the shift lever boots and remove it from the console.
2. Start the engine or turn the ignition switch to the ON position.
3. Move the shift lever.

If the brake pedal is repeatedly depressed and released with the shift

lever in the P (Park) position, a chattering noise & vibration near the shift lever may be heard. This is a normal condition.

⚠ WARNING

Always fully depress the brake pedal before and whilst shifting out of the P (Park) position into another position to avoid inadvertent motion of the vehicle which could injure persons in or around the vehicle.

Shift-lock override

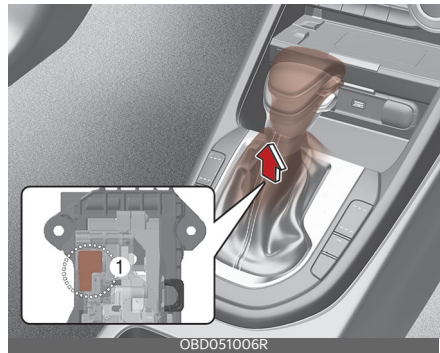

If the shift lever cannot be moved from the P (Park) position into R (Reverse) position with the brake pedal depressed, continue depressing the brake, and then do the following:

1. Remove the shift lever boots from the console by using a plastic trim tool.
2. After removing the boots, press and hold the button (1) on the left front side with a pointed tool and change it to the N (Neutral) position.

If the shift lever does not move even after performing this procedure, have the system inspected by a professional workshop. Kia recommends to visit an authorised Kia dealer/service partner.

⚠ CAUTION

- Be careful not to damage the cover when removing the shift lever boots.
- Be sure that the vehicle is in flat level ground when releasing the shift-lock.

Ignition key interlock system (if equipped)

The ignition key cannot be removed unless the shift lever is in the P (Park) position.

Good driving practices

- Never move the shift lever from P (Park) or N (Neutral) to any other position with the accelerator pedal depressed.
- Never move the shift lever into P (Park) when the vehicle is in motion.
- Be sure the car is completely stopped before you attempt to shift into R (Reverse) or D (Drive).
- Never take the car out of gear and coast down a hill. This may be extremely hazardous. Always leave the car in gear when moving.
- Do not "ride" the brakes. This can cause them to overheat and malfunction. Instead, when you are driving down a long hill, slow down and shift to a lower gear. When you do this, engine braking will help slow the car.
- Slow down before shifting to a lower gear. Otherwise, the lower gear may not be engaged.
- Always use the parking brake. Do not depend on placing the transmission in P (Park) to keep the car from moving.
- Exercise extreme caution when driving on a slippery surface. Be especially careful when braking, accelerating or shifting gears. On a

slippery surface, an abrupt change in vehicle speed can cause the drive wheels to lose traction and the vehicle to go out of control.

- Optimum vehicle performance and economy is obtained by smoothly depressing and releasing the accelerator pedal.

⚠ WARNING

- When driving uphill or downhill, always shift to D (Drive) for driving forward or shift to R (Reverse) for driving backwards, and check the gear position indicated on the cluster before driving.

Driving in the opposite direction of the selected gear can lead to a dangerous situation by shutting off the engine and affecting the braking performance.

- Always buckle-up! In a collision, an unbelted occupant is significantly more likely to be seriously injured or killed than a properly belted occupant.
- Avoid high speeds when cornering or turning.
- Do not make quick steering wheel movements, such as sharp lane changes or fast, sharp turns.
- The risk of rollover is greatly increased if you lose control of your vehicle at highway speeds.
- Loss of control often occurs if two or more wheels drop off the roadway and the driver oversteers to reenter the roadway.
- In the event your vehicle leaves the roadway, do not steer sharply. Instead, slow down before pulling back into the travel lanes.

- Never exceed posted speed limits.

⚠ WARNING

If your vehicle becomes stuck in snow, mud, sand, etc., then you may attempt to rock the vehicle free by moving it forward and backward. Do not attempt this procedure if people or objects are anywhere near the vehicle. During the rocking operation the vehicle may suddenly move forward or backward as it becomes unstuck, causing injury or damage to nearby people or objects.

Intelligent variable transmission (IVT) (if equipped)

The Intelligent Variable Transmission (IVT) automatically shifts depending on speed, accelerate pedal position. The individual speeds are selected automatically, depending on the position of the shift lever.

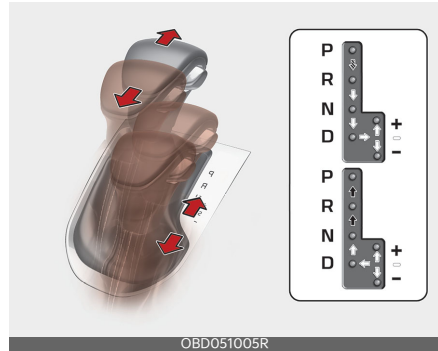

- ➡ Depress the brake pedal and the lock release button when shifting.
- ➡ Press the lock release button when shifting.
- ➡ The shift lever can be shifted freely.

Intelligent Variable Transmission (IVT) operation

For smooth operation, depress the brake pedal when shifting from N (Neutral) to a forward or reverse gear.

⚠ WARNING

Intelligent Variable Transmission (IVT)

- Always check the surrounding areas near your vehicle for people, especially children, before shifting a car into D (Drive) or R (Reverse).
- Before leaving the driver's seat, always make sure the shift lever is in the P (Park) position; then set the

parking brake fully and shut the engine off. Unexpected and sudden vehicle movement can occur if these precautions are not followed in the order identified.

- Do not use the engine brake (shifting from a high gear to lower gear) rapidly on slippery roads.
The vehicle may slip causing an accident.

CAUTION

- To avoid damage to your transmission, do not accelerate the engine in R (Reverse) or any forward gear position with the brakes on.
- When stopped on an incline, do not hold the vehicle stationary with engine power. Use the service brake or the parking brake.
- Do not shift from N (Neutral) or P (Park) into D (Drive), or R (Reverse) when the engine is above idle speed.

IVT warning message

A warning message is displayed on the LCD in a warning condition.

Transmission overheated



- When driving under severe conditions such as repeated suddenstarts and sudden acceleration, the transmission may overheat, and a warning sound and a warning message appear on the instrument cluster due to the self-protection mode.
- If this occurs, pull over to a safe location, stop the vehicle with the engine running, apply brakes and shift the gear to P (Park), and allow the transmission to cool.
- If the warning message continues to appear, have the system checked by a professional workshop to prevent unexpected accidents.

Vehicle power limited

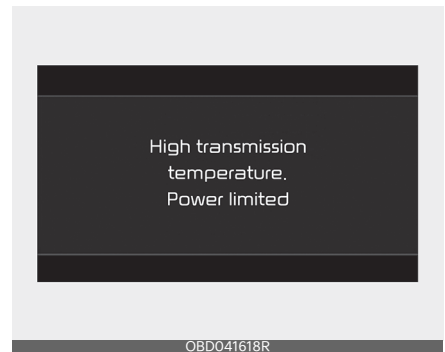

- If the transmission continues to drive overheating and reaches its maximum temperature, the above warning message appears. In this case, the vehicle limits transmission power by its self-protection mode.
- When such a situation occurs, normal driving is restricted until the transmission goes down to normal temperature, so after moving the vehicle to a safe place, shift the gear to P (Park) with the engine running and wait sev-

eral minutes until the warning on the screen disappears.

- If the warning message continues to appear, have the system checked by a professional workshop to prevent unexpected accidents.

Transmission cooled



- When the message "Trans cooled. Resume driving" appears you can continue to drive your vehicle.

Transmission ranges

The indicator in the instrument cluster displays the shift lever position when the ignition switch or ENGINE START/STOP is in the ON position.

P (Park)

Always come to a complete stop before shifting into P (Park). This position locks the transmission and prevents the front wheels from rotating.

⚠ WARNING

- Shifting into P (Park) whilst the vehicle is in motion will cause the drive wheels to lock which will cause you to lose control of the vehicle.
- Do not use the P (Park) position in place of the parking brake. Always

make sure the shift lever is latched in the P (Park) position and set the parking brake fully.

- Never leave a child unattended in a vehicle.

⚠ CAUTION

The transmission may be damaged if you shift into P (Park) whilst the vehicle is in motion.

⚠ CAUTION

The RPM (revolution per minute) may increase or decrease when performing the Intelligent Variable Transmission (IVT) self-diagnosis.

R (Reverse)

Use this position to drive the vehicle backward.

⚠ CAUTION

Always come to a complete stop before shifting into or out of R (Reverse); you may damage the transmission if you shift into R whilst the vehicle is in motion, except as explained in "Rocking the vehicle" on page 6-191.

N (Neutral)

The wheels and transmission are not engaged. The vehicle will roll freely even on the slightest incline unless the parking brake or service brakes are applied.

⚠ WARNING

Do not drive with the shift lever in N (Neutral).

The engine brake will not work and lead to an accident.

D (Drive)

This is the normal forward driving position. The transmission will automatically shift, providing the best fuel economy and power.

For extra power when passing another vehicle or climbing grades, depress the accelerator fully, at which time the transmission will automatically downshift to the next lower gear.

* NOTICE

Always come to a complete stop before shifting into D (Drive).

Manual mode



Whether the vehicle is stationary or in motion, manual mode is selected by pushing the shift lever from the D (Drive) position into the manual gate. To return to D (Drive) range operation, push the shift lever back into the main gate.

Manual mode manages the driving dynamics by automatically adjusting the steering effort, and the engine and

transmission control logic for enhanced driver performance.

In manual mode, moving the shift lever backwards and forwards will allow you to make gearshifts rapidly. In contrast to a manual transmission, the manual mode allows gearshifts with the accelerator pedal depressed.

- Up (+): Push the lever forward once to shift up one gear.
- Down (-): Pull the lever backwards once to shift down one gear.

* NOTICE

- Only the 8 forward gears can be selected. To reverse or park the vehicle, move the shift lever to the R (Reverse) or P (Park) position as required.
- Downshifts are made automatically when the vehicle slows down. When the vehicle stops, 1st gear is automatically selected.
- When the engine rpm approaches the red zone shift points are varied to upshift automatically.
- To maintain the required levels of vehicle performance and safety, the system may not execute certain gearshifts when the shift lever is operated.
- When driving on a slippery road, push the shift lever forward into the + (up) position. This causes the transmission to shift into the 2nd gear which is better for smooth driving on a slippery road. Push the shift lever to the - (down) side to shift back to the 1st gear.
- When manual mode is activated:
 - The engine rpm will tend to remain raised over a certain length of time even after releasing the accelerator.

- Upshifts are delayed when accelerating.
- In manual mode, the fuel efficiency may decrease.

Shift lock system (if equipped)

For your safety, the Intelligent Variable Transmission (IVT) has a shift lock system which prevents shifting the transmission from P (Park) into R (Reverse) unless the brake pedal is depressed.

To shift the transmission from P (Park) into R (Reverse):

1. Depress and hold the brake pedal.
2. Start the engine or turn the ignition switch to the ON position.
3. Move the shift lever.

If the brake pedal is repeatedly depressed and released with the shift lever in the P (Park) position, a chattering noise near the shift lever may be heard. This is a normal condition.

⚠ WARNING

Always fully depress the brake pedal before and whilst shifting out of the P (Park) position into another position to avoid inadvertent motion of the vehicle which could injure persons in or around the vehicle.

Shift-lock override

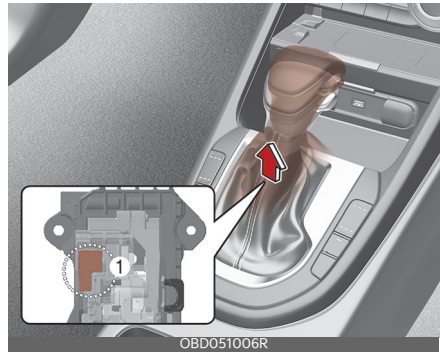

If the shift lever cannot be moved from the P (Park) position into R (Reverse) position with the brake pedal depressed, continue depressing the brake, and then do the following:

1. Remove the shift lever boots from the console by using a plastic trim tool.
2. After removing the boots, press and hold the button (1) on the left front side with a pointed tool and change it to the N (Neutral) position.

If the shift lever does not move even after performing this procedure, have the system inspected by a professional workshop. Kia recommends to visit an authorised Kia dealer/service partner.

⚠ CAUTION

- Be careful not to damage the cover when removing the shift lever boots.
- Be sure that the vehicle is in flat level ground when releasing the shift-lock.

Good driving practices

- Never move the shift lever from P (Park) or N (Neutral) to any other position with the accelerator pedal depressed.

- Never move the shift lever into P (Park) when the vehicle is in motion.
- Be sure the vehicle is completely stopped before you attempt to shift into R (Reverse) or D (Drive).
- Never take the vehicle out of gear and coast down a hill. This may be extremely hazardous. Always leave the vehicle in gear when moving.
- Do not "ride" the brakes. This can cause them to overheat and malfunction. Instead, when you are driving down a long hill, slow down and shift to a lower gear. When you do this, engine braking will help slow down the vehicle.
- Slow down before shifting to a lower gear. Otherwise, the lower gear may not be engaged.
- Always use the parking brake. Do not depend on placing the transmission in P (Park) to keep the vehicle from moving.
- Exercise extreme caution when driving on a slippery surface. Be especially careful when braking, accelerating or shifting gears. On a slippery surface, an abrupt change in vehicle speed can cause the drive wheels to lose traction and the vehicle to go out of control.
- Optimum vehicle performance and economy is obtained by smoothly depressing and releasing the accelerator pedal.

WARNING

- When driving uphill or downhill, always shift to D (Drive) for driving forward or shift to R (Reverse) for driving backwards, and check the gear position indicated on the cluster before driving.

Driving in the opposite direction of the selected gear can lead to a dangerous situation by shutting off the engine and affecting the braking performance.

- Always buckle-up! In a collision, an unbelted occupant is significantly more likely to be seriously injured or killed than a properly belted occupant.
- Avoid high speeds when cornering or turning.
- Do not make quick steering wheel movements, such as sharp lane changes or fast, sharp turns.
- The risk of a rollover is greatly increased if you lose control of your vehicle at highway speeds.
- Losing control often occurs if two or more wheels drop off the roadway and the driver oversteers to reenter the roadway.
- In the event your vehicle leaves the roadway, do not steer sharply. Instead, slow down before pulling back into the travel lanes.
- Never exceed posted speed limits.

WARNING

If your vehicle becomes stuck in snow, mud, sand, etc., then you may attempt to rock the vehicle free by moving it forward and backward. Do not attempt this procedure if people or objects are anywhere near the vehicle. During the rocking operation the vehicle may suddenly move forward or backward as it becomes unstuck, causing injury or damage to nearby people or objects.

Moving up a steep grade from a standing start

To move up a steep grade from a standing start:

1. Depress the brake pedal, shift the shift lever to D (Drive).
2. Select the appropriate gear depending on load weight and steepness of the grade, and release the parking brake.
3. Depress the accelerator gradually whilst releasing the service brakes.

Brake system

Power brakes

Your vehicle has power-assisted brakes that adjust automatically through normal usage.

In the event that the power-assisted brakes lose power because of a stalled engine or some other reason, you can still stop your vehicle by applying greater force to the brake pedal than you normally would. The stopping distance, however, will be longer.

When the engine is not running, the reserve brake power is partially depleted each time the brake pedal is applied. Do not pump the brake pedal when the power assist has been interrupted.

Pump the brake pedal only when necessary to maintain steering control on slippery surfaces.

* NOTICE

- When stepping on the brake pedal under a certain driving or weather condition, you may witness your car make a sound of squealing or some other noises. This is not a brake malfunction but a normal phenomenon.
- When driving on the road to which deicing chemicals are applied, the vehicle may witness noises from the brake or abnormal abrasion of tyres because of such deicing chemicals. You should operate brake additionally so that you would be able to remove the deicing chemicals on the brake disk and pad under a safe traffic condition.

⚠ WARNING**Brakes**

- Do not drive with your foot resting on the brake pedal. This will create abnormal high brake temperatures, excessive brake lining and pad wear, and increased stopping distances.
- When descending a long or steep hill, shift to a lower gear and avoid continuous application of the brakes. Continuous brake application will cause the brakes to over heat and could result in a temporary loss of braking performance.
- Wet brakes may impair the vehicle's ability to safely slow down; the vehicle may also pull to one side when the brakes are applied. Applying the brakes lightly will indicate whether they have been affected in this way. Always test your brakes in this fashion after driving through deep water. To dry the brakes, apply them lightly whilst maintaining a safe forward speed until brake performance returns to normal.
- Always, confirm the position of the brake and accelerator pedal before driving. If you don't check the position of the accelerator and brake pedal before driving, you may depress the accelerator instead of the brake pedal. It may cause a serious accident.

In the event of brake failure

If service brakes fail to operate whilst the vehicle is in motion, you can make an emergency stop with the parking brake. The stopping distance, however, will be much greater than normal.

⚠ WARNING**Parking brake**

Applying the parking brake whilst the vehicle is moving at normal speeds can cause a sudden loss of control of the vehicle. If you must use the parking brake to stop the vehicle, use great caution in applying the brake.

Disc brakes wear indicator

Your vehicle has disc brakes.

When your brake pads are worn and new pads are required, you will hear a high-pitched warning sound from your front brakes or rear brakes. You may hear this sound come and go or it may occur whenever you depress the brake pedal.

⚠ CAUTION

- To avoid costly brake repairs, do not continue to drive with worn brake pads.
- Always replace the front or rear brake pads as pairs.

⚠ WARNING**Brake wear**

This brake wear warning sound means your vehicle needs service. If you ignore this audible warning, you will eventually lose braking performance, which could lead to a serious accident.

Rear drum brakes (if equipped)

Your rear drum brakes do not have wear indicators. Therefore, have the rear brake linings inspected if you hear a rear brake rubbing noise. Also have your rear brakes inspected each time you change

or rotate your tyres and when you have the front brakes replaced.

Parking brake (Hand-type) (if equipped)

Applying the parking brake

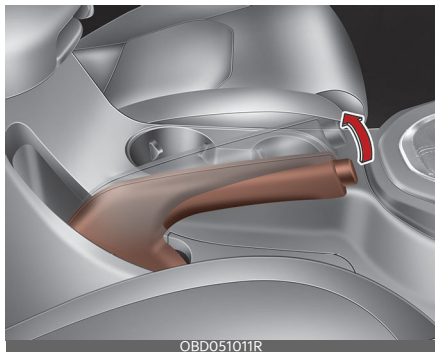

To engage the parking brake, first apply the foot brake and then pull up the parking brake lever as far as possible.

In addition it is recommended that when parking the vehicle on an incline, the shift lever should be into the 1st gear (for Manual Transmission) or in the P (Park, for Automatic Transmission) vehicles.

⚠ CAUTION

- Driving with the parking brake applied will cause excessive brake pad and brake rotor wear.
- Do not operate the parking brake whilst the vehicle is moving except in an emergency situation. It could damage the vehicle system and make endanger driving safety.

Releasing the parking brake

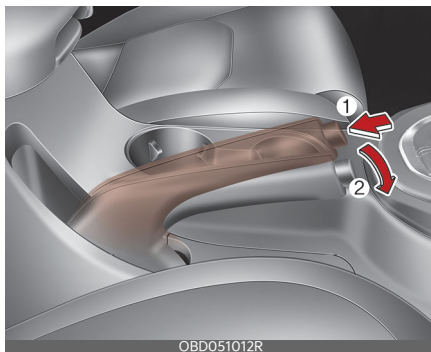

To release the parking brake, first apply the foot brake and pull up the parking brake lever slightly. Secondly depress the release button (1) and lower the parking brake lever (2) whilst holding the button.

If the parking brake does not release or does not release all the way, have the system checked by a professional workshop. Kia recommends to visit an authorised Kia dealer/service partner.

- Be cautious when parking on a hill. Firmly engage the parking brake and place the shift lever in first or reverse gear (manual transmission). If your vehicle is facing downhill, turn the front wheels into the kerb to help keep the vehicle from rolling. If your vehicle is facing uphill, turn the front wheels away from the kerb to help keep the vehicle from rolling. If there is no kerb or if it is required by other conditions to keep the vehicle from rolling, block the wheels.
- Under some conditions your parking brake can freeze in the engaged position. This is most likely to happen when there is an accumulation of snow or ice around or near the rear brakes or if the brakes are wet. If

there is a risk that the parking brake may freeze, apply it only temporarily whilst you put the shift lever in first or reverse gear (manual transmission) and block the rear wheels so the vehicle cannot roll. Then release the parking brake.

- Do not hold the vehicle on the upgrade with the accelerator pedal. This can cause the transmission to overheat. Always use the brake pedal or parking brake.

WARNING

- Never allow anyone who is unfamiliar with the vehicle to touch the parking brake. If the parking brake is released unintentionally, serious injury may occur.
- All vehicles should always have the parking brake fully engaged when parking to avoid inadvertent movement of the vehicle which can injure occupants or pedestrians.

Type A



Type B



Check the brake warning light by turning the ignition switch or ENGINE START/STOP button ON (do not start the engine). This light will be illuminated when the parking brake is applied with the ignition switch or ENGINE START/STOP button in the START or ON position.

Before driving, be sure the parking brake is fully released and the brake warning light is off.

If the brake warning light remains on after the parking brake is released whilst engine is running, there may be a malfunction in the brake system. Immediate attention is necessary.

If at all possible, cease driving the vehicle immediately. If that is not possible, use extreme caution whilst operating the vehicle and only continue to drive the vehicle until you can reach a safe location or repair shop.

Electronic Parking Brake (EPB) (if equipped)

Applying the parking brake



To apply the EPB (electronic parking brake) manually:

1. Stop the vehicle.
2. Depress the brake pedal and pull up the EPB switch. Make sure the warning light comes on.

EPB may be automatically applied when:

- Requested by other systems.
- If the driver applies the EPB whilst the engine is ON then turn the engine off, the EPB may be applied again automatically.

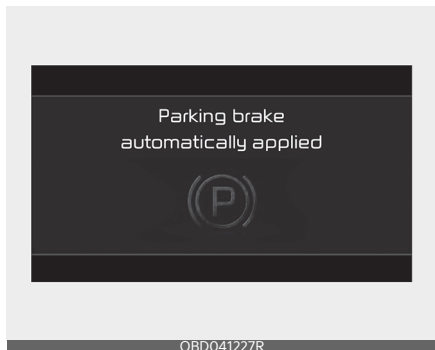

- If the driver turns the engine off by mistake whilst Auto Hold (if equipped) is operating, EPB will be automatically applied. But if the driver turns the engine off and push the EPB switch in 1 second, the EPB does not apply.

Emergency braking

- If there is a problem with the brake pedal whilst driving, emergency braking is possible by pulling up and holding the EPB switch. Braking is possible only whilst you are holding the EPB switch. If you hand off the EPB switch, the braking force is lost. If you hold the EPB switch and the vehicle stop, the EPB is applied.
- During emergency braking by the EPB, the parking brake warning light will illuminate and the warning sounds will occur to indicate that the system is operating.
- The braking distance may be longer than under normal braking conditions.

* EPB stands for Electronic Parking Brake.

⚠ WARNING

Do not operate the parking brake whilst the vehicle is moving except in an emergency situation. It could damage the

vehicle system and endanger driving safety.

⚠ CAUTION

If you continuously notice a noise or burning smell when the EPB is used for emergency braking, have the system checked by a professional workshop. Kia recommends visiting an authorised Kia dealer/service partner.

Releasing the parking brake

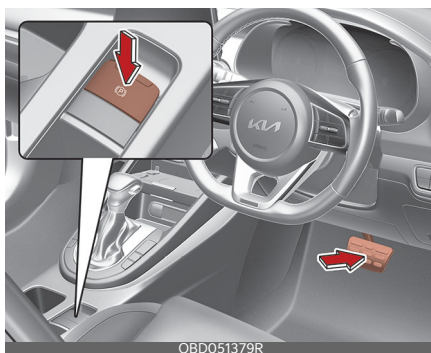

To release the EPB manually:

Press the EPB switch in the following condition.

- Have the ignition switch or ENGINE START/STOP button in the ON position.
- Depress the brake pedal.
- Make sure the brake warning light goes off.

To release EPB automatically (manual transmission):

1. Close the driver's door, engine bonnet and trunk/tailgate.
2. Fasten the driver's seat belt.
3. Start the engine.

4. Depress the clutch pedal with the gear engaged.
5. Depress the accelerator pedal whilst releasing the clutch pedal.

To release EPB automatically (automatic transmission):

1. Close the driver's door, engine bonnet and trunk/tailgate.
2. Fasten the driver's seat belt.
3. Start the engine.
4. If the shift lever is in P (Park), depress the brake pedal and shift out of P (Park) to R (Rear) or D (Drive), the EPB is released automatically. Make sure the brake warning light goes off.
5. If the shift lever is in N (Neutral), depress the brake pedal and shift out of N (Neutral) to R (Rear) or D (Drive), the EPB is released automatically. Make sure the brake warning light goes off.
 - If you try to drive off depressing the accelerator pedal with the EPB applied, but doesn't release automatically, a warning will sound once and a message will appear.

4Door

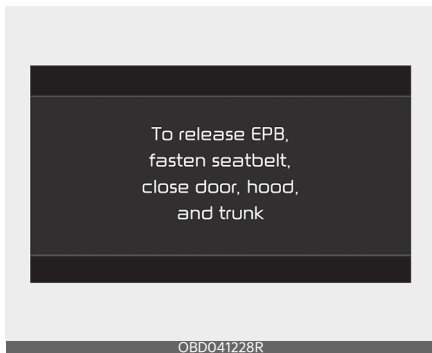

5Door

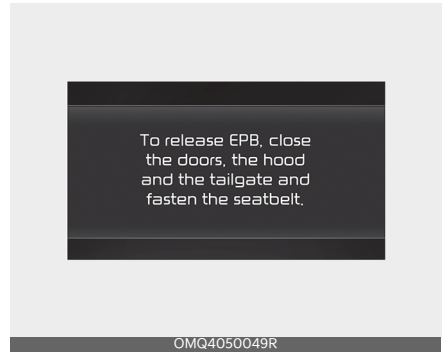

- If the driver's seat belt is not fastened, driver's door is opened, the engine bonnet is opened in D or the trunk/tailgate is opened in R, a warning will sound once and a message will appear.
- If there is a problem with the vehicle, a warning may sound once and a message may appear. If the above situation occurs, depress the brake pedal and release EPB by pressing the EPB switch.

⚠ WARNING

- Never allow anyone who is unfamiliar with the vehicle to touch the parking brake. If the parking brake is released unintentionally, serious injury may occur.
- Do not place any objects around the EPB switch. They could release the EPB switch.

⚠ CAUTION

- To prevent unintentional movement when stopped and leaving the vehicle, do not use the shift lever in place of the parking brake. Set the parking brake and make sure the shift lever is

securely positioned in P (Park). Use wheel chokes if necessary.

- In winter or cold conditions, the EPB may freeze. Park the vehicle with the shift lever in P on the even and safe place without applying the EPB. And use wheel chokes.
- Do not drive your vehicle with the EPB applied. It may cause excessive wear of brake pad and brake rotor.
- A click sound may be heard whilst operating or releasing the EPB, but these conditions are normal and indicate that the EPB is functioning properly.
- When leaving your keys with a parking lot attendant or valet, make sure to inform him/her how to operate the EPB.
- When the battery is drained, the EPB does not apply or release. In this case, jump start your vehicle.

Malfunction of EPB

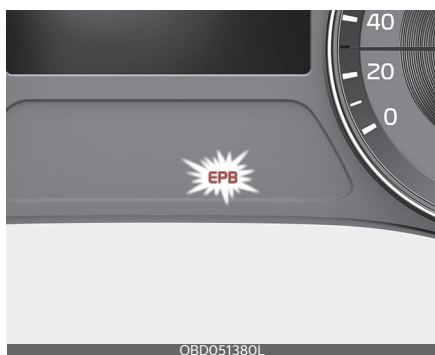

If the EPB malfunction indicator remains on, it indicates that the EPB may have malfunctioned. If this occurs, have the system checked by a professional workshop. Kia recommends visiting an authorised Kia dealer/service partner.

The EPB malfunction indicator may illuminate when the ESC indicator comes on to indicate that the ESC is not working properly, but it does not indicate a malfunction of the EPB.

⚠ CAUTION

- The EPB warning light may illuminate if the EPB switch operates abnormally. Shut the engine off and turn it on again after a few minutes. The warning light will go off and the EPB switch will operate normally. However, if the EPB warning light is still on, have the system checked by a professional workshop. Kia recommends to visit an authorised Kia dealer/service partner.
- If the parking brake warning light does not illuminate or blinks even though the EPB switch was pulled up, the EPB is not applied. If the parking brake warning light blinks when the EPB warning light is on, press the switch, then pull it up. Once more press it back to its original position and pull it back up. If the EPB warning does not go off, have the system checked by a professional workshop. Kia recommends to visit an authorised Kia dealer/service partner.

AUTO HOLD (if equipped)

The Auto Hold is designed to maintain the vehicle in a standstill even though the brake pedal is not pressed after the driver brings the vehicle to a complete stop by pressing the brake pedal.

Applying Auto Hold function

1. Press the brake pedal and start the vehicle.
2. Press the Auto Hold button. The white AUTO HOLD indicator will come on indicating the system is in standby.

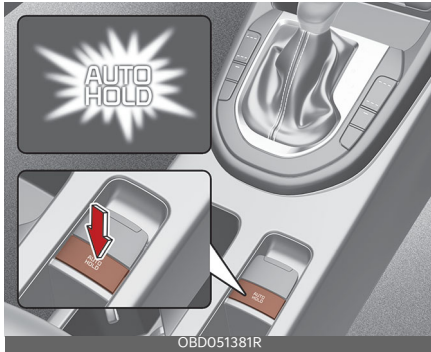

Before the Auto Hold will engage, the driver's door, trunk/tailgate and engine bonnet must be closed.



When coming to a complete stop by pressing the brake pedal, the AUTO HOLD indicator changes from white to green indicating the AUTO HOLD is engaged. The vehicle will remain at a standstill even if you release the brake pedal.

If EPB is applied, Auto Hold will be released.

If you press the accelerator pedal with the gear in D (Drive), R (Reverse) or manual mode, the Auto Hold will be released automatically and the vehicle will start to move. The indicator changes from green to white indicating the Auto

Hold is in standby and the EPB is released.

When driving off from Auto Hold by pressing the accelerator pedal, always check the surrounding area near your vehicle.

Slowly press the accelerator pedal for a smooth launch.

Canceling Auto Hold function

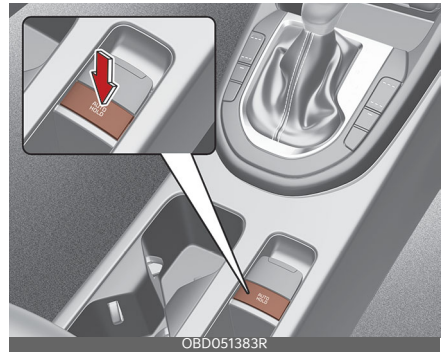

- To cancel the Auto Hold operation, press the Auto Hold switch. The AUTO HOLD indicator will go out.
- To cancel the Auto Hold operation when the vehicle is at a standstill, press the Auto Hold switch whilst pressing the brake pedal.

* NOTICE

- The following are conditions when the Auto Hold will not engage (Auto Hold light will not turn green and the Auto Hold system remains in stand by):
 - The driver's door is opened
 - The engine bonnet is opened
 - The trunk/tailgate is opened
 - The gear is in P (Park)
 - The EPB is applied
- For your safety, the Auto Hold automatically switches to EPB under any of the following conditions (Auto Hold

light remains white and the EPB automatically applies):

- The driver's door is opened.
- The engine bonnet is opened.
- The trunk/tailgate is opened
- The vehicle is in a standstill for more than 10 minutes.
- The vehicle is standing on a steep slope.
- The vehicle moved for a few seconds.

In these cases, the brake warning light comes on, the AUTO HOLD indicator changes from green to white, and a warning sounds and a message will appear to inform you that EPB has been automatically engaged. Before driving off again, press foot brake pedal, check the surrounding area near your vehicle and release parking brake manually with the EPB switch.

- If the AUTO HOLD indicator lights up yellow, the Auto Hold is not working properly. Take your vehicle to a professional workshop and have the system checked. Kia recommends to visit an authorised Kia dealer/service partner.

⚠ WARNING

To reduce the risk of an accident, do not activate Auto Hold whilst driving downhill, backing up or parking your vehicle.

If there is a malfunction with the driver's door, trunk/tailgate or engine bonnet open detection system, the Auto Hold may not work properly.

Take your vehicle to a professional workshop and have the system checked.

Kia recommends to visit an authorised Kia dealer/service partner.

*** NOTICE**

A click or electric brake motor whine sound may be heard whilst operating or releasing the EPB, but these conditions are normal and indicate that the EPB is functioning properly.

Warning messages

The Auto Hold function will display a warning message with sound under certain conditions.

When the EPB is applied from Auto Hold, a warning will sound and a message will appear.

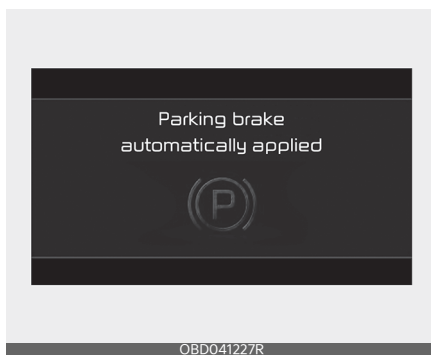

When the conversion from Auto Hold to EPB is not working properly a warning will sound and a message will appear.

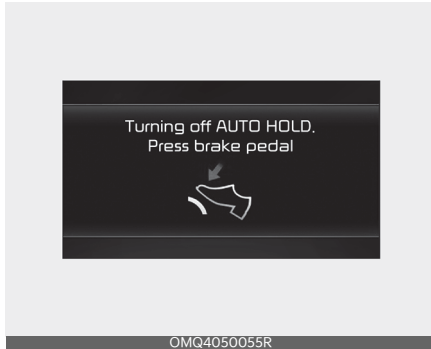

*** NOTICE**

When this message is displayed, the Auto Hold and EPB may not operate. For your safety, press the brake pedal.

If you do not apply the brake pedal when you release the Auto Hold by pressing the [AUTO HOLD] switch, a warning will sound and a message will appear.

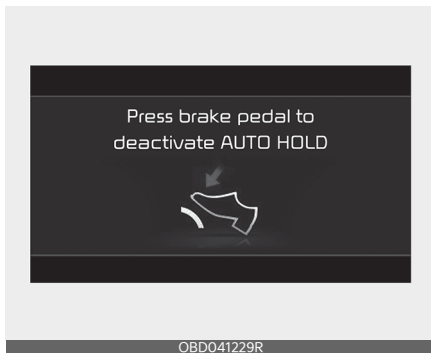

When you press the [AUTO HOLD] switch, if the driver's door, trunk/tailgate and engine bonnet are not closed, a warning will sound and a message will appear on the LCD display.

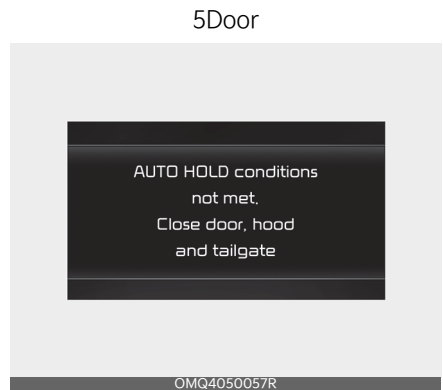
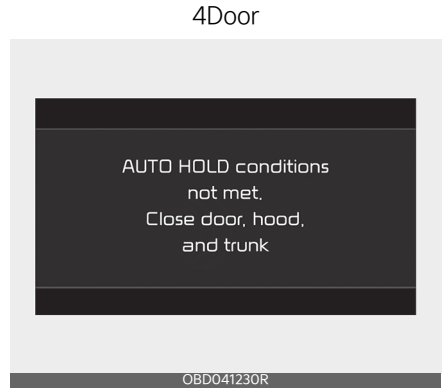

At this moment, press the [AUTO HOLD] button after closing the driver's door and engine bonnet.

Anti-lock brake system (ABS)

⚠ WARNING

ABS (or ESC) will not prevent accidents due to improper or dangerous driving manoeuvres. Even though vehicle control is improved during emergency braking, always maintain a safe distance between you and objects ahead. Vehicle speeds should always be reduced during extreme road conditions.

The braking distance for cars equipped with an anti-lock braking system (or Electronic Stability Control system) may

be longer than for those without it in the following road conditions.

During these conditions the vehicle should be driven at reduced speeds:

- Rough, gravel or snow-covered roads.
- With tyre chains installed.
- On roads where the road surface is pitted or has different surface height.

The safety features of an ABS (or ESC) equipped vehicle should not be tested by high speed driving or cornering. This could endanger the safety of yourself or others.

The ABS continuously senses the speed of the wheels. If the wheels are going to lock, the ABS system repeatedly modulates the hydraulic brake pressure to the wheels.

When you apply your brakes under conditions which may lock the wheels, you may hear a “tik-tik” sound from the brakes, or feel a corresponding sensation in the brake pedal. This is normal and it means your ABS is active.

In order to obtain the maximum benefit from your ABS in an emergency situation, do not attempt to modulate your brake pressure and do not try to pump your brakes. Press your brake pedal as hard as possible or as hard as the situation warrants and allow the ABS to control the force being delivered to the brakes.

* NOTICE

A click sound may be heard in the engine compartment when the vehicle begins to move after the engine is started. These conditions are normal and indicate that the anti-lock brake system is functioning properly.

- Even with the anti-lock brake system, your vehicle still requires sufficient stopping distance. Always maintain a safe distance from the vehicle in front of you.
- Always slow down when cornering. The anti-lock brake system cannot prevent accidents resulting from excessive speeds.
- On loose or uneven road surfaces, operation of the anti-lock brake system may result in a longer stopping distance than for vehicles equipped with a conventional brake system.



⚠ CAUTION

- If the ABS warning light is on and stays on, you may have a problem with the ABS. In this case, however, your regular brakes will work normally.
- The ABS warning light will stay on for approximately 3 seconds after the ignition switch or ENGINE START/STOP button is ON. During that time, the ABS will go through self diagnosis and the light will go off if everything is normal. If the light stays on, you may have a problem with your ABS. In this case, have the system checked by a professional workshop. Kia recommends to visit an authorised Kia dealer/service partner.

⚠ CAUTION

- When you drive on a road having poor traction, such as an icy road, and operate your brakes continuously, the ABS will be active continuously and

the ABS warning light may illuminate. Pull your car over to a safe place and stop the engine.

- Restart the engine. If the ABS warning light is off, then your ABS system is normal. Otherwise, you may have a problem with the ABS. In this case, have the system checked by a professional workshop. Kia recommends to visit an authorised Kia dealer/service partner.

* NOTICE

When you jump start your vehicle because of a drained battery, the engine may not run as smoothly and the ABS warning light may turn on at the same time. This happens because of the low battery voltage. It does not mean your ABS is malfunctioning.

- Do not pump your brakes!
- Have the battery recharged before driving the vehicle.

Electronic Stability Control (ESC) (if equipped)

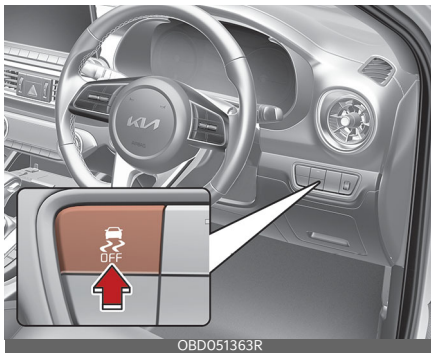

The Electronic Stability Control (ESC) system is designed to stabilize the vehicle during cornering manoeuvres. ESC

checks where you are steering and where the vehicle is actually going. ESC applies the brakes at individual wheels and intervenes in the engine management system to stabilize the vehicle.

⚠ WARNING

Never drive too fast for the road conditions or too quickly when cornering. Electronic Stability Control (ESC) will not prevent accidents. Excessive speed in turns, abrupt manoeuvres and hydroplaning on wet surfaces can still result in serious accidents. Only a safe and attentive driver can prevent accidents by avoiding manoeuvres that cause the vehicle to lose traction. Even with ESC installed, always follow all the normal precautions for driving - including driving at safe speeds for the conditions.

The Electronic Stability Control (ESC) system is an electronic system designed to help the driver maintain vehicle control under adverse conditions. It is not a substitute for safe driving practices. Factors including speed, road conditions and driver steering input can all affect whether ESC will be effective in preventing a loss of control. It is still your responsibility to drive and corner at reasonable speeds and to leave a sufficient margin of safety.

When you apply your brakes under conditions which may lock the wheels, you may hear a “tik-tik” sound from the brakes, or feel a corresponding sensation in the brake pedal. This is normal and it means your ESC is active.

* NOTICE

A click sound may be heard in the engine compartment when the vehicle

begins to move after the engine is started. These conditions are normal and indicate that the Electronic Stability Control System is functioning properly.

ESC operation

ESC ON condition

- When the ignition switch or ENGINE START/STOP button is turned ON, ESC and ESC OFF indicator lights illuminate for approximately 3 seconds, then ESC is turned on.
- Press the ESC OFF button after turning the ignition switch or ENGINE START/STOP button ON to turn ESC off. (ESC OFF indicator will illuminate). To turn the ESC on, press the ESC OFF button (ESC OFF indicator light will go off).
- When starting the engine, you may hear a slight ticking sound. This is the ESC performing an automatic system self-check and does not indicate a problem.

When operating



When the ESC is in operation, the ESC indicator light blinks.

- When the Electronic Stability Control is operating properly, you can feel a slight pulsation in the vehicle. This is only the effect of brake control and indicates nothing unusual.
- When moving out of the mud or driving on a slippery road, the engine rpm (revolution per minute) may not be increased even if you press the accelerator pedal deeply. This is to maintain the stability and traction of the vehicle and does not indicate a problem.

ESC OFF condition



To cancel ESC operation :

- State 1

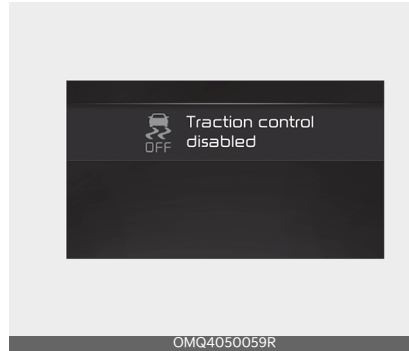

Press the ESC OFF button shortly (ESC OFF indicator light and message illuminates). At this state, the engine control function does not operate. In other words, the traction control function does not operate but only the brake control function operates.

- State 2

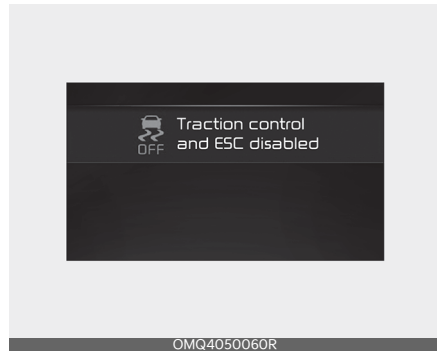

Press the ESC OFF button for more than 3 seconds. ESC OFF indicator light and message illuminates and ESC OFF warning chime will sound. At this state, the engine control function and brake control function does not operate. In other words, the vehicle

stability control function does not operate any more.

If the ignition switch or ENGINE START/STOP button is placed to the LOCK/OFF position when ESC is off, ESC remains off. Upon restarting the engine, the ESC will automatically turn on again.

Indicator light

ESC indicator light



ESC OFF indicator light



When the ignition switch or ENGINE START/STOP button is turned to ON, the indicator light illuminates, then goes off if the ESC system is operating normally. The ESC indicator light blinks whenever ESC is operating or illuminates when ESC fails to operate.

The ESC OFF indicator light comes on when the ESC is turned off with the button.

CAUTION

Driving with varying tyre or wheel sizes may cause the ESC system to malfunction. Make sure they are the same type, size, brand, construction and tread pattern as the original tyres and wheels installed.

WARNING

The Electronic Stability Control system is only a driving aid; use precautions for safe driving by slowing down on curved, snowy, or icy roads. Drive slowly and don't attempt to accelerate whenever

the ESC indicator light is blinking, or when the road surface is slippery.

ESC OFF usage

When driving

- ESC should be turned on for daily driving whenever possible.
- To turn ESC off whilst driving, press the ESC OFF button whilst driving on a flat road surface.

Never press the ESC OFF button whilst ESC is operating (ESC indicator light blinks).

If ESC is turned off whilst ESC is operating, the vehicle may slip out of control.

*** NOTICE**

- When operating the vehicle on a dynamometer, ensure that the ESC is turned off (ESC OFF light illuminated).
- Turning the ESC off does not affect ABS or brake system operation.

WARNING

Never press the ESC OFF button whilst ESC is operating.

If the ESC is turned off whilst ESC is operating, the vehicle may go out of control.

To turn ESC off whilst driving, press the ESC OFF button whilst driving on a flat road surface.

Hill-start assist control (HAC) (if equipped)

Hill start Assist Control is a comfort function. The main intend is to prevent the vehicle from rolling backwards whilst driving off uphill on an inclined surface. HAC holds the braking pressure buildup

by driver during stopping procedure for 2 seconds after releasing brake pedal. During the pressure-hold period, the driver has enough time to press the accelerator pedal to drive off.

The braking pressure is reduced as soon as the system detects the driver's intention to drive off.

WARNING

The HAC is usually activated only for 2 seconds. The driver should be careful from the rolling backward causing the accident with behind objects or human, when the driver may feel the unintended rolling backward whilst driving off on hill due to insufficient brake hold pressure built-up by driver during stopping procedure.

NOTICE

- The HAC does not operate when the transmission shift lever is in the P (Park) or N (Neutral) position.
- The HAC activates even though the ESC is off but it does not activate when the ESC has malfunctioned.

Vehicle stability management (VSM) (if equipped)

This system provides further enhancements to vehicle stability and steering responses when a vehicle is driving on a slippery road or a vehicle detected changes in coefficient of friction between right wheels and left wheels when braking.

VSM operation

When the VSM is in operation, ESC indicator light () blinks.

When the vehicle stability management is operating properly, you can feel a

slight pulsation in the vehicle. This is only the effect of brake control and indicates nothing unusual.

The VSM does not operate when:

- Driving on bank road such as gradient or incline
- Driving rearward
- ESC OFF indicator light () remains on the instrument cluster
- MDPS indicator light remains on the instrument cluster

VSM operation off

If you press the ESC OFF button to turn off the ESC, the VSM will also cancel and the ESC OFF indicator light () illuminates.

To turn on the VSM, press the button again. The ESC OFF indicator light goes out.

Malfunction indicator

The VSM can be deactivated even if you don't cancel the VSM operation by pressing the ESC OFF button. It indicates that a malfunction has been detected somewhere in the Electric Power Steering system or VSM system. If the ESC indicator light () or MDPS warning light remains on, have the system checked by a professional workshop. Kia recommends to visit an authorised Kia dealer/service partner.

WARNING

- The Vehicle Stability Management system is not a substitute for safe driving practices but a supplementary function only. It is the responsibility of the driver to always check the speed and the distance to the vehicle ahead.

Always hold the steering wheel firmly whilst driving.

- Your vehicle is designed to activate according to the driver's intention, even with installed VSM. Always follow all the normal precautions for driving at safe speeds for the conditions - including driving in inclement weather and on a slippery road.
- Driving with varying tyre or wheel sizes may cause the VSM system to malfunction. Make sure they are the same type, size, brand, construction and tread pattern as the original tyres and wheels installed.

ESS : Emergency Stop Signal

The Emergency Stop Signal system alerts the driver behind by blinking the stop light when the vehicle suddenly stops or when the ABS activates in a stop. (The system activates when the vehicle speed is over 55 km/h and the vehicle deceleration is over 7 m/s² or the ABS activates when the vehicle emergency braking.)

When the vehicle speed is under 40 km/h and the ABS deactivates or the sudden stop situation is over, the stop light blinking will stop.

CAUTION

The Emergency Stop Signal system will not work if the hazard warning flasher is already on.

Good braking practices

WARNING

- Whenever leaving vehicle or parking, always set the parking brake as far as possible and fully engage the vehicle's transmission into the park position.

Vehicles not fully engaged in park with the parking brake set are at risk for moving inadvertently and injuring yourself or others.

- All vehicles should always have the parking brake fully engaged when parking to avoid inadvertent movement of the car which can injure occupants or pedestrians.

- After parking the vehicle, check to be sure the parking brake is not engaged and that the parking brake indicator light is out before driving away.

- Driving through water may get the brakes wet. They can also get wet when the car is washed. Wet brakes can be dangerous! Your car will not stop as quickly if the brakes are wet. Wet brakes may cause the car to pull to one side.

- To dry the brakes, apply the brakes lightly until the braking action returns to normal, taking care to keep the car under control at all times. If the braking action does not return to normal, stop as soon as it is safe to do so and have your vehicle inspected by a professional workshop.

Kia recommends to call an authorised Kia dealer/service partner.

- Don't coast down hills with the car out of gear. This is extremely hazardous. Keep the car in gear at all times, use the brakes to slow down, then shift to a lower gear so that engine braking will help you maintain a safe speed.
- Don't "ride" the brake pedal. Resting your foot on the brake pedal whilst driving can be dangerous because it can result in the brakes overheating and losing their effectiveness. It also

increases the wear of the brake components.

- If a tyre goes flat whilst you are driving, apply the brakes gently and keep the car pointed straight ahead whilst you slow down. When you are moving slowly enough for it to be safe to do so, pull off the road and stop in a safe place.
- Be cautious when parking on a hill. Firmly engage the parking brake and place the shift lever in P (Park). If your car is facing downhill, turn the front wheels into the kerb to help keep the car from rolling. If your car is facing uphill, turn the front wheels away from the kerb to help keep the car from rolling. If there is no kerb or if it is required by other conditions to keep the car from rolling, block the wheels.
- Under some conditions your parking brake can freeze in the engaged position. This is most likely to happen when there is an accumulation of snow or ice around or near the rear brakes or if the brakes are wet. If there is a risk that the parking brake may freeze, apply it only temporarily whilst you put the shift lever in P (Park) and block the rear wheels so the car cannot roll. Then release the parking brake.
- Do not hold the vehicle on the upgrade with the accelerator pedal. This can cause the transmission to overheat. Always use the brake pedal or parking brake.

Drive mode integrated control system

Drive mode

The drive mode may be selected according to the driver's preference or road condition.

* NOTICE

If there is a problem with the instrument cluster, the drive mode will be in NORMAL mode and may not change to ECO mode or SPORT mode.

The mode changes when you toggle the DRIVE MODE button.

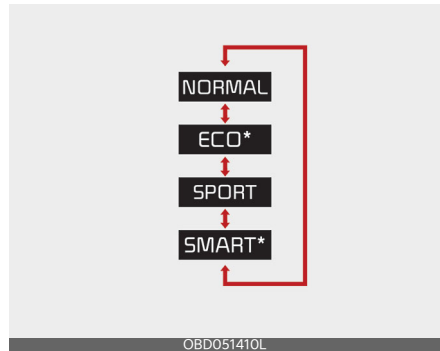

* : if equipped

When NORMAL mode is selected, it is not displayed on the instrument cluster.

- ECO mode :
ECO mode helps improve fuel efficiency for eco-friendly driving.
- NORMAL mode :
NORMAL mode provides smooth driving and comfortable riding.
- SPORT mode :
SPORT mode provides sporty but firm riding.

The drive mode will change to NORMAL mode when the engine is restarted.

ECO mode

ECO When the Drive Mode is set to ECO mode, the engine and transmission control logic are changed to maximize fuel efficiency.

- When the ECO mode is selected by using the DRIVE MODE button, the ECO indicator will illuminate.
- Whenever the engine is restarted, the drive mode remains in NORMAL mode.

* NOTICE

Fuel efficiency depends on the driver's driving habit and road condition.

When ECO mode is activated:

- The acceleration response may be slightly reduced as the accelerator pedal is depressed moderately.
- The air conditioner performance may be limited.
- The shift pattern of the automatic transmission may change.
- The engine noise may get louder.

The above situations are normal conditions when ECO mode is activated to improve fuel efficiency.

Limitation of ECO mode operation:

If the following conditions occur whilst ECO mode is operating, the system operation is limited even though there is no change in ECO indicator.

- When the coolant temperature is low:
The system will be limited until engine performance becomes normal.
- When driving up a hill:

The system will be limited to gain power when driving uphill because engine torque is restricted.

- When the accelerator pedal is deeply depressed for a few seconds:
The system will be limited, judging that the driver wants to speed up.

SPORT mode

SPORT SPORT mode manages the driving dynamics by automatically adjusting the steering effort, the engine and transmission control logic for enhanced driver performance.

- When SPORT mode is selected by using the DRIVE MODE button, the SPORT indicator will illuminate.
- Whenever the engine is restarted, the Drive Mode will revert back to NORMAL mode. If SPORT mode is desired, re-select SPORT mode from the DRIVE MODE button.
- When SPORT mode is activated:
 - The engine rpm will tend to remain raised over a certain length of time even after releasing the accelerator
 - Upshifts are delayed when accelerating

* NOTICE

In SPORT mode, the fuel efficiency may decrease.

SMART mode

SMART SMART mode selects the proper driving mode among ECO, NORMAL, and SPORT by judging the driver's driving habits (i.e. Economic or Aggressive (Sportive)) from the brake pedal depression or the steering wheel operation.

- Toggle the DRIVE MODE button to select SMART mode. When SMART mode is selected, the indicator illuminates on the instrument cluster.
- SMART mode automatically controls the vehicle driving, such as gear shifting patterns and engine torque, in accordance with the driver's driving habits.

* NOTICE

- When you mildly drive the vehicle in SMART mode, the driving mode changes to ECO mode to improve fuel efficiency. However, the actual fuel efficiency may differ in accordance with your driving situations (i.e. upward/downward slope, vehicle deceleration/acceleration).
- When you dynamically drive the vehicle in SMART mode by abruptly decelerating or sharply turning the driving mode changes to SPORT mode. However, it may adversely affect fuel economy.

Various driving situations, which you may encounter in SMART mode

- The driving mode automatically changes to ECO mode after a certain period of time, when you gently depress the accelerator pedal. (Your driving is categorized to be economic.)
- The driving mode automatically changes from SMART ECO mode to SMART NORMAL mode after a certain period of time, when you sharply or repetitively depress the accelerator pedal.
- The driving mode automatically changes to SMART NORMAL mode

with the same driving patterns, when the vehicle starts to drive on an upward slope of a certain angle. The driving mode automatically returns to SMART ECO mode, when the vehicle enters a leveled road.

- The driving mode automatically changes to SMART SPORT, when you abruptly accelerate the vehicle or repetitively operate the steering wheel. (Your driving is categorized to be sporty.) In this mode, your vehicle drives in a lower gear for abrupt accelerating/decelerating and increases the engine brake performance.
- You may still sense the engine braking performance, even when you release the accelerator pedal in SMART SPORT mode. It is because your vehicle remains in lower gear over a certain period of time for next acceleration. Thus, it is a normal driving situation, not indicating any malfunction.
- The driving mode automatically changes to SMART SPORT mode only in harsh driving situations. In most of the normal driving situations, the driving mode sets to be either in SMART ECO mode or in SMART NORMAL mode.

Limitation of SMART mode

The SMART mode may be limited in following situations. (The OFF indicator illuminates in those situations.)

- Cruise Control is activated:
Cruise Control may deactivate the SMART mode when the vehicle is controlled by the set speed of Smart Cruise Control. (SMART mode is not

deactivated just by activating Cruise Control.)

- The transmission oil temperature is either extremely low or extremely high:

The SMART mode can be active in most of the normal driving situations. However, an extremely high/low transmission oil temperature may temporarily deactivate the SMART mode, because the transmission condition is out of normal operation condition.

Forward Collision-Avoidance Assist (FCA) (Front view camera only) (if equipped)

Basic function

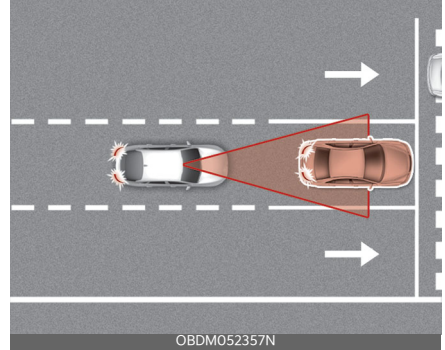

Forward Collision-Avoidance Assist is designed to help detect and monitor the vehicle ahead or help detect a pedestrian in the roadway and warn the driver that a collision is imminent with a warning message and an audible warning, and if necessary, apply emergency braking.

6

Detecting sensor



[1]: Front view camera

Refer to the picture above for the detailed location of the detecting sensors.

⚠ CAUTION

Take the following precautions to maintain optimal performance of the detecting sensor:

- Never disassemble the detecting sensor or sensor assembly, or apply any impact on it.
- If the detecting sensors have been replaced or repaired, we recommend that the vehicle be inspected by an authorised Kia dealer/service partner.
- Never install any accessories or stickers on the front windscreen, or tint the front windscreen.
- Pay extreme caution to keep the front view camera dry.
- Never place any reflective objects (i.e. white paper, mirror) over the dashboard. Any light reflection may prevent the function from functioning properly.

Forward Collision-Avoidance Assist Settings

Forward safety

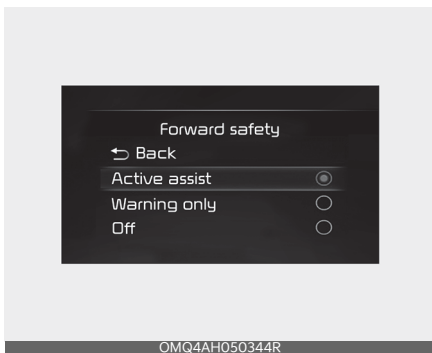

With the ignition switch or ENGINE START/STOP button in the ON position, select 'Driver assistance → Forward safety' from the 'User settings (LCD display) or Setup → Vehicle (Infotainment System screen)' menu to set whether or not to use each function.

- If 'Active assist' is selected, the function will warn the driver with a warning message and an audible warning and steering wheel vibration (if equipped) depending on the collision risk levels. Braking assist will be applied depending on the collision risk.
- If 'Warning only' is selected, the function will warn the driver with a warning message and an audible warning and steering wheel vibration (if equipped) depending on the collision risk levels. Braking and steering (if equipped) will not be assisted.
- If 'Off' is selected, the function will be turned off. The  warning light will illuminate on the cluster.

The driver can monitor Forward Collision-Avoidance Assist ON/OFF status

from the settings menu. If the  warning light remains ON when the function is ON, we recommend that the function be inspected by an authorised Kia dealer/service partner.

⚠ WARNING

- When the engine is restarted, Forward Collision-Avoidance Assist will always turn on.
- If 'Off' is selected from the settings menu, the Forward Collision Assist will not operate so the driver should

always be aware of the surroundings and drive safely.

⚠ CAUTION

- If 'Warning only' is selected, braking is not assisted.
- Steering wheel vibration can be turned on or off. Select or deselect 'User settings → Driver assistance → Haptic warning' (LCD Display) or 'Set up → Vehicle → Driver Assistance → Warning Methods → Haptic Warning' (infotainment system screen)

* NOTICE

Forward Collision-Avoidance Assist will turn off when ESC is turned off by pressing and holding the ESC OFF button and the  warning light will illuminate on the cluster.

Warning timing

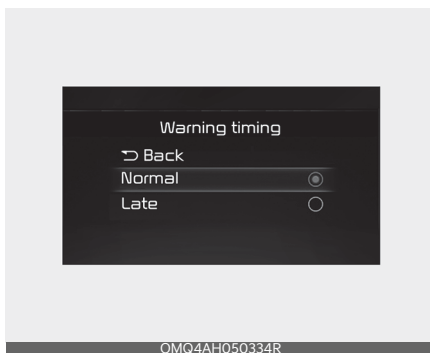

With the ignition switch or ENGINE START/STOP button in the ON position, select 'Driver assistance → Warning timing' from the 'User settings (LCD display) or Setup → Vehicle (Infotainment System screen)' menu to change the initial

warning activation time for Forward Collision-Avoidance Assist.

When the vehicle is first delivered, Warning timing is set to 'Normal'.

If you change the Warning Timing, the warning time of other Driver Assistance functions may change.

Warning volume

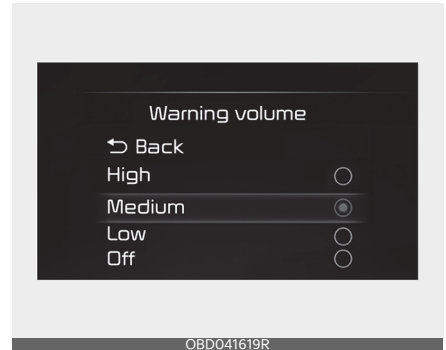

With the ignition switch or ENGINE START/STOP button in the ON position, select 'User settings → Driver assistance → Warning volume' from the LCD display or 'Setup → Vehicle → Warning Methods → Warning Volume' from Infotainment System screen menu to change the Warning Volume to 'High', 'Medium', 'Low' or 'Off' (if equipped) for Forward Collision-Avoidance Assist. However, even if 'Off' is selected, the Warning volume of Forward Collision Avoidance Assist will not turn off but the volume will sound as 'Low'.

If you change the Warning volume, the Warning volume of other Driver Assistance functions may change.

⚠ CAUTION

- The setting of the Warning timing and Warning volume applies to all functions of Forward Collision-Avoidance Assist.

- Even though 'Normal' is selected for Warning Timing, if the front vehicle suddenly stops, the initial warning activation time may seem late.
- Select 'Late' for Warning Timing when traffic is light and when driving speed is slow.

*** NOTICE**

If the engine is restarted, Warning timing and warning volume will maintain the last setting.

Forward Collision-Avoidance Assist Operation

Warning and control

The basic function for Forward Collision-Avoidance Assist is to warn and control the vehicle depending on the collision level: 'Collision warning!', 'Emergency braking' and 'Stopping vehicle and ending brake control'.

Collision warning!



- To warn the driver of a collision, the 'Collision warning!' warning message will appear on the cluster, an audible warning will sound and the steering wheel will vibrate.

- If a vehicle is detected in front, the function will operate when your vehicle speed is between approximately 10 ~ 180 km/h (6 ~ 112 mph).
- If a pedestrian is detected in front, the function will operate when your vehicle speed is between approximately 10 ~ 60 km/h (6 ~ 37 mph).
- If 'Active assist' is selected, braking may be assisted.

Emergency braking

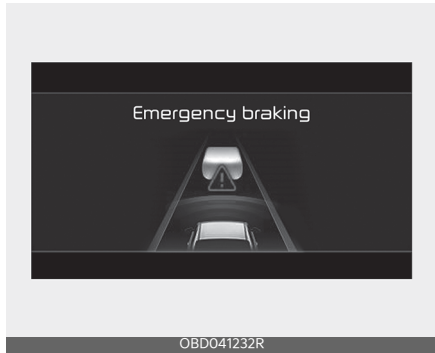

- To warn the driver that emergency braking will be assisted, the 'Emergency braking' warning message will appear on the cluster, an audible warning will sound and the steering wheel will vibrate.
- If a vehicle is detected in front, the function will operate when your vehicle speed is between approximately 10~180 km/h (6~112 mph).
- If a pedestrian is detected in front, the function will operate when your vehicle speed is between approximately 10 ~ 60 km/h (6 ~ 37 mph).
- In emergency braking situation, braking is assisted with strong braking power by the function to help prevent collision with the vehicle or pedestrian.

Stopping vehicle and ending brake control

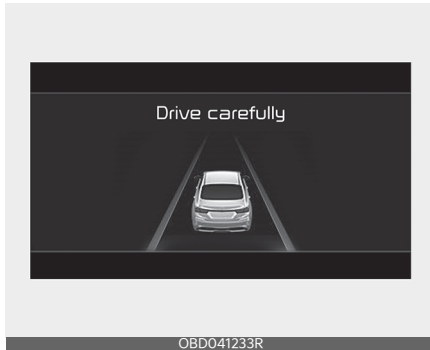

- When the vehicle is stopped due to emergency braking, the 'Drive carefully' warning message will appear on the cluster.
 - For your safety, the driver should depress the brake pedal immediately and check the surroundings.
 - Brake control will end after the vehicle is stopped by emergency braking for approximately 2 seconds.
- ⚠ WARNING
- For your safety, change the settings after parking the vehicle at a safe location.
 - With 'Active assist' or 'Warning Only' selected, when ESC is turned off by pressing and holding the ESC OFF button, Forward Collision-Avoidance Assist will turn off automatically. In this case, the function cannot be set from the settings menu and the warning light will illuminate on the cluster which is normal. If ESC is turned on by pressing the ESC OFF button, Forward Collision-Avoidance Assist will maintain the last setting.
 - Forward Collision-Avoidance Assist does not operate in all situations or cannot avoid all collisions.
 - The driver should hold the responsibility to control the vehicle. Do not solely depend on Forward Collision-Avoidance Assist. Rather, maintain a safe braking distance, and if necessary, depress the brake pedal to reduce driving speed or to stop the vehicle.
 - Never deliberately operate Forward Collision-Avoidance Assist on people, animal, objects, etc. It may cause serious injury or death.
 - Forward Collision-Avoidance Assist may not operate if the driver depresses the brake pedal to avoid collision.
 - Depending on the road and driving conditions, Forward Collision-Avoidance Assist may warn the driver late or may not warn the driver.
 - During Forward Collision-Avoidance Assist operation, the vehicle may stop suddenly injuring passengers and shifting loose objects. Always have the seat belt on and keep loose objects secured.
 - If any other function's warning message is displayed or audible warning is generated, Forward Collision-Avoidance Assist warning message may not be displayed and audible warning may not be generated.
 - You may not hear the warning sound of Forward Collision-Avoidance Assist if the surrounding is noisy.
 - Forward Collision-Avoidance Assist may turn off or may not operate properly or may operate unnecessarily

depending on the road conditions and the surroundings.

⚠ WARNING

- Even if there is a problem with Forward Collision-Avoidance Assist, the vehicle's basic braking performance will operate normally.
- During emergency braking, braking control by the function will automatically cancel when the driver excessively depresses the accelerator pedal or sharply steers the vehicle.

⚠ CAUTION

Depending on the condition of the vehicle, pedestrian in front and the surroundings, the speed range to operate Forward Collision-Avoidance Assist may reduce. The function may only warn the driver, or the function may not operate.



*** NOTICE**

When a collision is imminent, the Forward Collision-Avoidance Assist may assist the driver with brakes if the driver fails to brake enough.

Forward Collision-Avoidance Assist malfunction and limitations

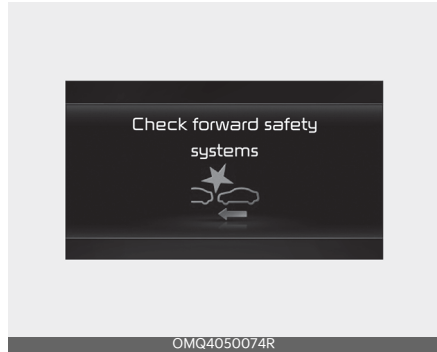
Forward Collision-Avoidance Assist malfunction



When Forward Collision-Avoidance Assist is not working properly, the 'Check forward safety systems' warning message will appear (turns off after a certain time), and the  and  warning lights will illuminate on the cluster. We recommend that the function be inspected by an authorised Kia dealer/service partner.

Forward Collision-Avoidance Assist disabled

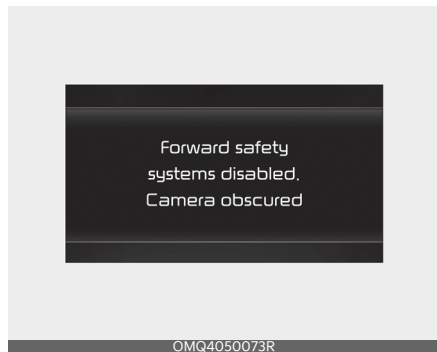

When the front windscreen where the front view camera is located, is covered with foreign material, such as snow or rain, it can reduce the detecting performance and temporarily limit or disable Forward Collision-Avoidance Assist.

If this occurs, the 'Forward safety systems disabled. Camera obscured' warning message will appear (turns off after a certain time), and the  warning lights will illuminate on the cluster.

The function will operate normally when snow, rain or foreign matter is removed. Always keep it clean.

If the function does not operate normally after obstruction (snow, rain, or foreign material) is removed, we recommend that the function be inspected by an authorised Kia dealer/service partner.

WARNING

- Even though the warning message or warning light does not appear on the cluster, Forward Collision-Avoidance Assist may not properly operate.
- Forward Collision-Avoidance Assist may not properly operate in an area (e.g. open terrain), where any substance are not detected after turning ON the engine.

Limitations of Forward Collision-Avoidance Assist

Forward Collision-Avoidance Assist may not operate normally, or the function may operate unexpectedly under the following circumstances:

- The detecting sensor or the surroundings are contaminated or damaged

- The temperature around the front view camera is high or low due to the external environment.
- The camera lens is contaminated due to tinted, filmed or coated windscreen, damaged glass, or stuck of foreign material (sticker, bug, etc.) on the glass
- Moisture is not removed or frozen on the windscreen
- Washer fluid is continuously sprayed, or the wiper is on
- Driving in heavy rain or snow, or thick fog
- The field of view of the front view camera is obstructed by sun glare
- Street light or light from an oncoming vehicle is reflected on the wet road surface, such as a puddle on the road
- An object is placed on the dashboard
- Your vehicle is being towed
- The surrounding is very bright
- The surrounding is very dark, such as in a tunnel, etc.
- The brightness changes suddenly, for example when entering or exiting a tunnel
- The brightness outside is low, and the headlamps are not on or are not bright
- Driving through steam, smoke or shadow
- Only part of the vehicle, pedestrian is detected
- The vehicle in front is a bus, heavy truck, truck with a unusually shaped luggage, trailer, etc.
- The vehicle in front has no tail lights, tail lights are located unusually, etc.
- The brightness outside is low, and the tail lamps are not on or are not bright

- The rear of the front vehicle is small or the vehicle does not look normal, such as when the vehicle is tilted, overturned, or the side of the vehicle is visible, etc.
- The front vehicle's ground clearance is low or high
- A vehicle or pedestrian suddenly cuts in front
- The vehicle in front is detected late
- The vehicle in front is suddenly blocked by an obstacle
- The vehicle in front suddenly changes lane or suddenly reduces speed
- The vehicle in front is bent out of shape
- The front vehicle's speed is fast or slow
- The vehicle in front steers in the opposite direction of your vehicle to avoid a collision
- With a vehicle in front, your vehicle changes lane at low speed
- The vehicle in front is covered with snow
- You are departing or returning to the lane
- You are driving unstably
- You are on a roundabout and the vehicle in front is not detected
- You are continuously driving in a circle
- The vehicle in front has an unusual shape
- The vehicle in front is driving uphill or downhill.
- The pedestrian is not fully detected, for example, if the pedestrian is leaning over or is not fully walking upright

- The pedestrian is wearing clothing or equipment that makes it difficult to detect as a pedestrian

Following image shows the image the sensor recognizes as vehicle and pedestrian.



- The pedestrian in front is moving very quickly
- The pedestrian in front is short or is posing a low posture
- The pedestrian in front has impaired mobility
- The pedestrian in front is moving intersected with the driving direction
- There is a group of pedestrians or a large crowd in front
- The pedestrian is wearing clothing that easily blends into the background, making it difficult to detect
- The pedestrian is difficult to distinguish from the similar shaped structure in the surroundings
- You are driving by a pedestrian, traffic signs, structures, etc. near the intersection
- You are driving by a pedestrian, traffic signs, structures, etc. near the intersection
- Driving in a parking lot

- Driving through a tollgate, construction area, unpaved road, partial paved road, uneven road, speed bumps, etc.
- Driving on an incline road, curved road, etc.
- Driving through a roadside with trees or streetlights
- The adverse road conditions cause excessive vehicle vibrations whilst driving
- Your vehicle height is low or high due to heavy loads, abnormal tyre pressure, etc.
- Driving through a narrow road where trees or grass or overgrown
- There is interference by electromagnetic waves, such as driving in an area with strong radio waves or electrical noise

⚠ WARNING

- **Driving on a curved road**

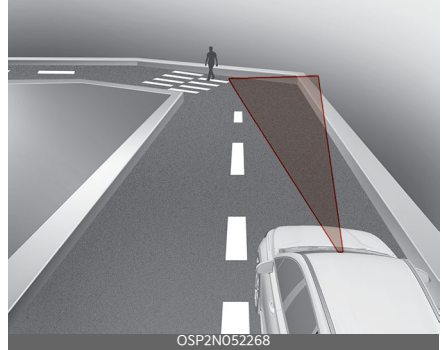
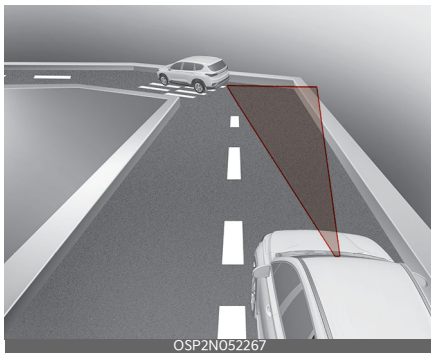

Forward Collision-Avoidance Assist may not detect other vehicles, pedestrians in front of you on curved roads adversely affecting the performance of the sensors. This may result in no warning, braking assist or steering assist when necessary.

When driving on a curve, you must maintain a safe braking distance, and if necessary, steer the vehicle and depress the brake pedal to reduce your driving speed in order to maintain a safe distance.

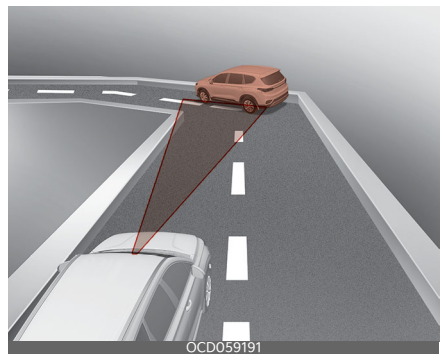

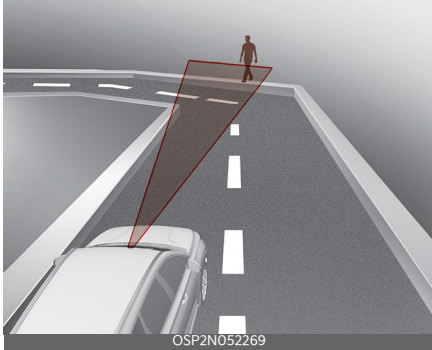

Forward Collision-Avoidance Assist may detect a vehicle, pedestrian in the next lane or outside the lane when driving on a curved road.

If this occurs, the function may unnecessarily warn the driver and control the brake or steering wheel. Always check the traffic conditions around the vehicle.

- **Driving on an inclined road**

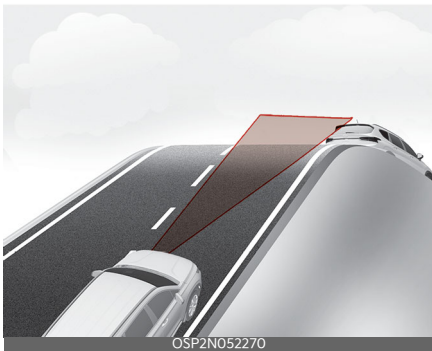

Forward Collision-Avoidance Assist may not detect other vehicles, pedestrians in front of you whilst driving uphill or downhill adversely affecting the performance of the sensors.

This may result in unnecessary warning, braking assist or steering assist or no warning, braking assist or steering assist when necessary.

Also, vehicle speed may rapidly decrease when a vehicle or pedestrian ahead is suddenly detected.

Always have your eyes on the road whilst driving uphill or downhill and if necessary, steer your vehicle and depress the brake pedal to reduce your driving speed in order to maintain a safe distance.

• Changing lanes

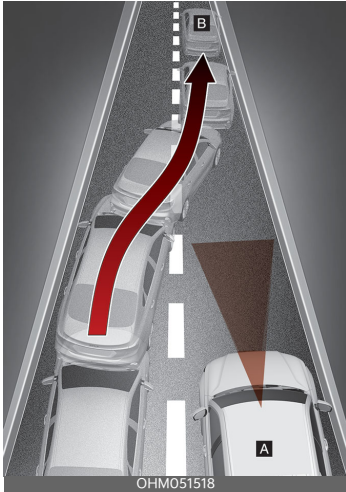

[A]: Your vehicle

[B]: Lane changing vehicle

When a vehicle [B] moves into your lane from an adjacent lane, it cannot be detected by the sensor until it is in the sensor's detection range. Forward Collision-Avoidance Assist may not immediately detect the vehicle when the vehicle changes lanes abruptly. In this case, you must maintain a safe braking distance, and if necessary, steer your vehicle and depress the brake pedal to reduce your driving speed in order to maintain a safe distance.

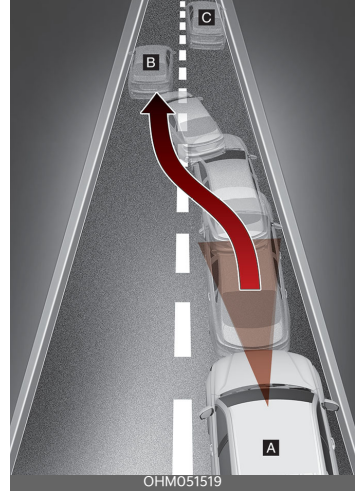

[A]: Your vehicle

[B]: Lane changing vehicle,

[C]: Same lane vehicle

When a vehicle [B] in front of you merges out of the lane, Forward Collision-Avoidance Assist may not immediately detect the vehicle [C] that is now in front of you. In this case, you must maintain a safe braking distance, and if necessary, steer your vehicle and depress the brake pedal to reduce your driving speed in order to maintain a safe distance.

• Detecting vehicle

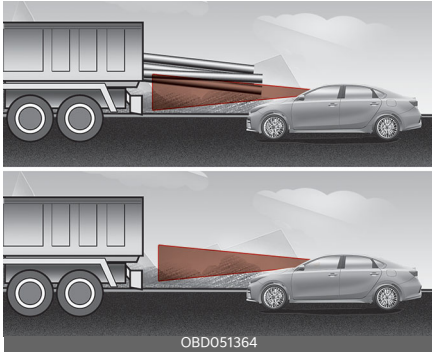

If the vehicle in front of you has cargo that extends rearward from the cab, or when the vehicle in front of you has higher ground clearance, additional special attention is required. Forward Collision-Avoidance Assist may not be able to detect the cargo extending from the vehicle. In these instances, you must maintain a safe braking distance from the rearmost object, and if necessary, steer your vehicle and depress the brake pedal to reduce your driving speed in order to maintain distance.

⚠ WARNING

- When you are towing a trailer or another vehicle, we recommend that Forward Collision-Avoidance Assist is turned off due to safety reasons.
- Forward Collision-Avoidance Assist may operate if objects that are similar in shape or characteristics to vehicles and pedestrians are detected.
- Forward Collision-Avoidance Assist does not operate on bicycles, motorcycles, or smaller wheeled objects, such as luggage bags, shopping carts, or strollers that are dragged by a pedestrian.

- Forward Collision-Avoidance Assist may not operate normally if interfered by strong electromagnetic waves.
- Forward Collision-Avoidance Assist may not operate for approximately 15 seconds after the vehicle is started, or the front view camera is initialized.

Forward Collision-Avoidance Assist (FCA) (Sensor fusion) (if equipped)

Basic function

Forward Collision-Avoidance Assist is designed to help detect and monitor the vehicle ahead or help detect a pedestrian or cyclist in the roadway and warn the driver that a collision is imminent with a warning message and an audible warning, and if necessary, apply emergency braking.

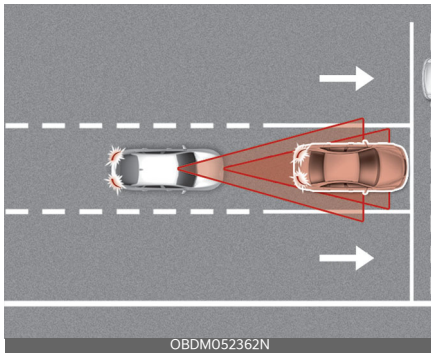

Detecting sensor



[1]: Front view camera, [2]: Front radar
Refer to the picture above for the detailed location of the detecting sensors.

⚠ CAUTION

Take the following precautions to maintain optimal performance of the detecting sensor:

- Never disassemble the detecting sensor or sensor assembly, or apply any impact on it.
- If the detecting sensor have been replaced or repaired have the vehicle inspected by a professional workshop. Kia recommends to visit an authorised Kia dealer/service partner.
- Never install any accessories or stickers on the front windscreen, or tint the front windscreen.
- Pay extreme caution to keep the front view camera dry.
- Never place any reflective objects (i.e. white paper, mirror) over the dashboard. Any light reflection may prevent the function from functioning properly.
- Do not apply license plate frame or objects, such as a bumper sticker, film or a bumper guard, near the front radar cover.

- Always keep the front radar and cover clean and free of dirt and debris. Use only a soft cloth to wash the vehicle. Do not spray pressurized water directly on the sensor or sensor cover.
- If unnecessary force has been applied to the radar or around the radar, Forward Collision-Avoidance Assist may not properly operate even though a warning message does not appear on the cluster. In this case, have the vehicle inspected by a professional workshop. Kia recommends to visit an authorised Kia dealer/service partner.
- The genuine Kia front radar sensor covers are parts with quality and performance ensured. If arbitrarily applying paint on or changing the cover, Forward Collision-Avoidance Assist may not function properly. Use only Kia Genuine Parts or those of an equivalent standard with proven quality and performance to repair or replace the radar sensor covers.

Forward Collision-Avoidance Assist settings

Forward safety



With the ignition switch or ENGINE START/STOP button in the ON position,

select 'Driver assistance → Forward safety' from the 'User settings (LCD display) or Setup → Vehicle (Infotainment System screen)' menu to set whether or not to use each function.

- If 'Active assist' is selected, the function will warn the driver with a warning message, an audible warning and steering wheel vibration depending on the collision risk levels.
- If 'Warning only' is selected, the function will warn the driver with a warning message, an audible warning and steering wheel vibration depending on the collision risk levels. Braking and steering (if equipped) will not be assisted. The driver must apply the brake pedal or steer the vehicle if necessary.
- If 'Off' is selected, the function will off. The  warning light will illuminate on the cluster.

The driver can monitor Forward Collision-Avoidance Assist ON/OFF status from the settings menu. If the  warning light remains ON when the function is ON, have the function checked by a professional workshop. Kia recommends to visit an authorised Kia dealer/service partner.

WARNING

- When the engine is restarted, Forward Collision-Avoidance Assist will always turn on.
- If 'Off' is selected from the settings menu, the Forward Collision Assist will not operate so the driver should always be aware of the surroundings and drive safely.

⚠ CAUTION

- If 'Warning only' is selected, braking is not assisted.
- Steering wheel vibration can be turned on or off. Select or deselect 'User settings → Driver assistance → Haptic warning' (LCD Display) or 'Set up → Vehicle → Driver Assistance → Warning Methods → Haptic Warning' (infotainment system screen)

*** NOTICE**

Forward Collision-Avoidance Assist will turn off when ESC is turned off by pressing and holding the ESC OFF button and the  warning light will illuminate.

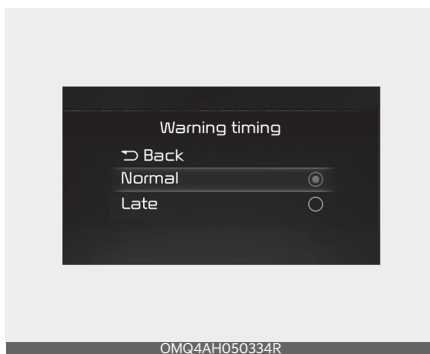
Warning timing

With the ignition switch or ENGINE START/STOP button in the ON position, select 'Driver assistance → Warning timing' from the 'User settings (LCD display) or Setup → Vehicle (Infotainment System screen)' menu to change the initial warning activation time for Forward Collision-Avoidance Assist.

When the vehicle is first delivered, Warning Timing is set to 'Normal'. If you change the Warning Timing, the warning

time of other Driver Assistance functions may change.

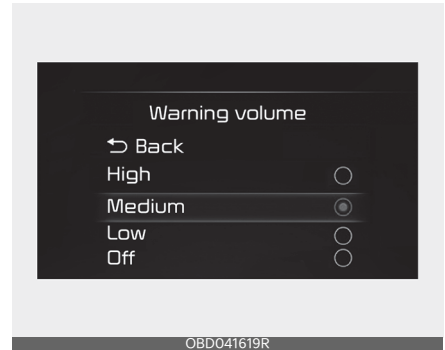
Warning volume

With the ignition switch or ENGINE START/STOP button in the ON position, select 'Driver assistance → Warning volume' from the 'User settings (LCD display) or Setup → Vehicle (Infotainment System screen)' menu to change the Warning Volume to 'High', 'Medium', 'Low' or 'Off' (if equipped) for Forward Collision-Avoidance Assist. However, even if 'Off' is selected, the Warning volume of Forward Collision Avoidance Assist will not turn off but the volume will sound as 'Low'.

If you change the Warning volume, the Warning volume of other Driver Assistance functions may change.

⚠ CAUTION

- The setting of the Warning timing and Warning volume applies to all functions of Forward Collision-Avoidance Assist.
- Even though 'Normal' is selected for Warning timing, if the front vehicle suddenly stops, the initial warning activation time may not seem late.

- Select 'Late' for Warning Timing when traffic is light and when driving speed is slow.

*** NOTICE**

If the engine is restarted, Warning timing and Warning volume will maintain the last setting.

*** NOTICE**

If your vehicle is equipped with additional Infotainment System, please scan the QR code in a separately supplied Car Infotainment System Quick Reference Guide.

Forward Collision-Avoidance Assist operation

Warning and control

The basic function for Forward Collision-Avoidance Assist is to warn and control the vehicle depending on the collision level: 'Collision warning!', 'Emergency braking' and 'Stopping vehicle and ending brake control'.

Collision warning!

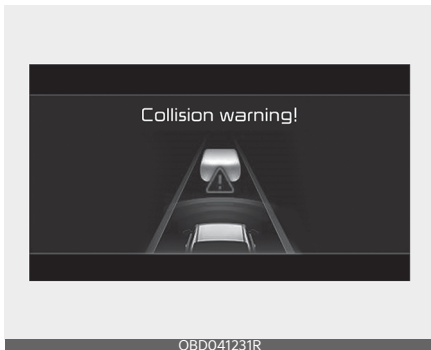

- To warn the driver of a collision, the 'collision warning!' warning message will appear on the cluster, an audible

warning will sound and the steering wheel will vibrate.

- If a vehicle is detected in front, the function will operate when your vehicle speed is between approximately 10~180 km/h (6~112 mph).
- If a pedestrian or cyclist is detected in front, the function will operate when your vehicle speed is between approximately 10~85 km/h (6~53 mph).
- If 'Active assist' is selected, braking may be assisted.

Emergency braking

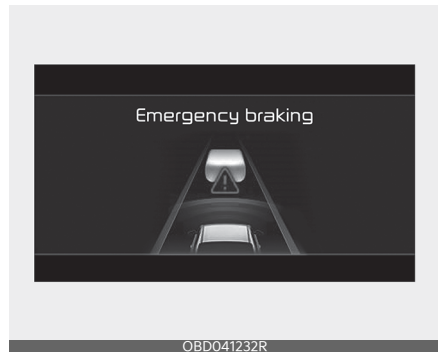

- To warn the driver that emergency braking will be assisted, the 'Emergency braking' warning message will appear on the cluster, an audible warning will sound and the steering wheel will vibrate.
- If a vehicle is detected in front, the function will operate when your vehicle speed is between approximately 10~180 km/h (6~112 mph).
- If a pedestrian or cyclist is detected in front, the function will operate when your vehicle speed is between approximately 10~85 km/h (6~52 mph).

- In emergency braking situation, braking is assisted with strong braking power by the function to help prevent collision with the vehicle, pedestrian or cyclist ahead.

Stopping vehicle and ending brake control

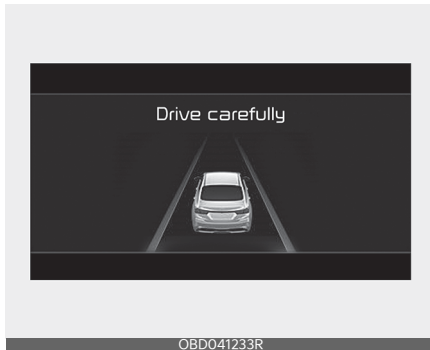

- When the vehicle is stopped due to emergency braking, the 'Drive carefully' warning message will appear on the cluster.
 - For your safety, the driver should depress the brake pedal immediately and check the surroundings.
 - Brake control will end after the vehicle is stopped by emergency braking for approximately 2 seconds.
- ⚠ WARNING
- For your safety, change the settings after parking the vehicle at a safe location.
 - With 'Active assist' or 'Warning only' selected, when ESC is turned off by pressing and holding the ESC OFF button, Forward Collision-Avoidance Assist will turn off automatically. In this case, the function cannot be set from the settings menu and the warning light will illuminate on the cluster which is normal. If ESC is turned on by pressing the ESC OFF button, Forward Collision-Avoidance Assist will maintain the last setting.
 - Forward Collision-Avoidance Assist does not operate in all situations or cannot avoid all collisions.
 - The driver should hold the responsibility to control the vehicle. Do not solely depend on Forward Collision-Avoidance Assist. Rather, maintain a safe braking distance, and if necessary, depress the brake pedal to reduce driving speed or to stop the vehicle.
 - Never deliberately operate Forward Collision-Avoidance Assist on people, animal, objects, etc. It may cause serious injury or death.
 - Forward Collision-Avoidance Assist may not operate if the driver depresses the brake pedal to avoid collision.
 - Depending on the road and driving conditions, Forward Collision-Avoidance Assist may warn the driver late or may not warn the driver.
 - During Forward Collision-Avoidance Assist operation, the vehicle may stop suddenly injuring passengers and shifting loose objects. Always have the seat belt on and keep loose objects secured.
 - If any other function's warning message is displayed or audible warning is generated, Forward Collision-Avoidance Assist warning message may not be displayed and audible warning may not be generated.
 - You may not hear the warning sound of Forward Collision-Avoidance Assist if the surrounding is noisy.
 - Forward Collision-Avoidance Assist may turn off or may not operate prop-

erly or may operate unnecessarily depending on the road conditions and the surroundings.

⚠ WARNING

- Even if there is a problem with Forward Collision-Avoidance Assist, the vehicle’s basic braking performance will operate normally.
- During emergency braking, braking control by the function will automatically cancel when the driver excessively depresses the accelerator pedal or sharply steers the vehicle.

⚠ CAUTION

- Depending on the condition of the vehicle, pedestrian and cyclist in front and the surroundings, the speed range to operate Forward Collision-Avoidance Assist may reduce. The function may only warn the driver, or the function may not operate.
- It operates only under certain conditions by judging the danger according to a condition of the oncoming vehicle, driving direction, speed and the surrounding environment.



*** NOTICE**

In a situation collision is imminent, braking may be assisted by Forward Collision-Avoidance Assist when braking is insufficient by the driver.

Forward Collision-Avoidance Assist malfunction and limitations

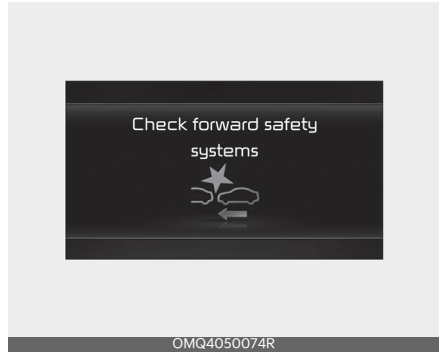
Forward Collision-Avoidance Assist malfunction



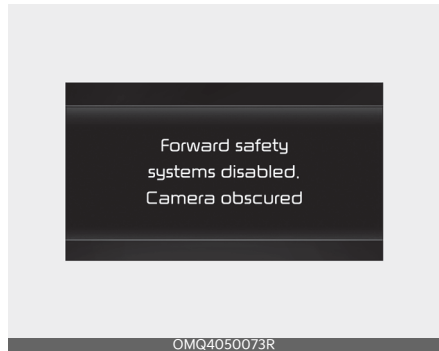

When Forward Collision-Avoidance Assist is not working properly, the ‘Check forward safety systems’ warning message will appear (turns off after a certain time), and the  and  warning lights will illuminate on the cluster. Kia recommends to visit an authorised Kia dealer/service partner.

Forward Collision-Avoidance Assist disabled

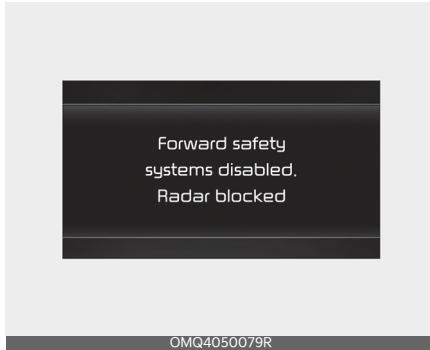



When the front windshield where the front view camera is located, front radar cover or sensor is covered with foreign material such as snow or rain, it can reduce the detecting performance and temporarily limit or disable Forward Collision-Avoidance Assist. If this occurs the 'Forward Safety system disabled. Radar blocked' warning message will appear (turns off after a certain time), and the  and  warning lights will illuminate on the cluster.

The function will operate normally when snow, rain or foreign matter is removed. If the function does not operate normally after it is removed, have the vehicle inspected by a professional workshop. Kia recommends to visit an authorised Kia dealer/service partner.

WARNING

- Even though the warning message or warning light does not appear on the cluster, Forward Collision-Avoidance Assist may not properly operate.
- Forward Collision-Avoidance Assist may not properly operate in an area (e.g. open terrain), where any substance are not detected after turning ON the engine.

Limitations of Forward Collision-Avoidance Assist

Forward Collision-Avoidance Assist may not operate normally, or the function may operate unexpectedly under the following circumstances:

- The detecting sensor or the surroundings are contaminated or damaged
- The temperature around the front view camera is high or low due to the external environment
- The camera lens is contaminated due to tinted, filmed or coated windshield, damaged glass, or stuck of foreign matters (sticker, bug, etc.) on the glass
- Moisture is not removed or frozen on the windshield
- Washer fluid is continuously sprayed, or the wiper is on
- Driving in heavy rain or snow, or thick fog
- The field of view of the front view camera is obstructed by sun glare
- Street light or light from an oncoming vehicle is reflected on the wet road surface, such as a puddle on the road
- An object is placed on the dashboard
- Your vehicle is being towed
- The surrounding is very bright
- The surrounding is very dark, such as in a tunnel, etc.
- The brightness changes suddenly, for example when entering or exiting a tunnel
- The brightness outside is low, and the headlamps are not on or are not bright
- Driving through steam, smoke or shadow

- Only part of the vehicle, pedestrian or cyclist is detected
- The vehicle in front is a bus, heavy truck, truck with a unusually shaped luggage, trailer, etc.
- The vehicle in front has no tail lights, tail lights are located unusually, etc.
- The brightness outside is low, and the tail lamps are not on or are not bright
- The rear of the front vehicle is small or the vehicle does not look normal, such as when the vehicle is tilted, overturned, or the side of the vehicle is visible, etc.
- The front vehicle's ground clearance is low or high
- A vehicle, pedestrian or cyclist suddenly cuts in front
- The bumper around the front radar is impacted, damaged or the front radar is out of position
- The temperature around the front radar is high or low
- Driving through a tunnel or iron bridge
- Driving in large areas where there are few vehicles or structures (i.e. desert, meadow, suburb, etc.)
- Driving near areas containing metal substances, such as a construction zone, railroad, etc.
- A material is near that reflects very well on the front radar, such as a guardrail, nearby vehicle, etc.
- The cyclist in front is on a bicycle made of material that does not reflect on the front radar
- The vehicle in front is detected late
- The vehicle in front is suddenly blocked by an obstacle
- The vehicle in front suddenly changes lane or suddenly reduces speed
- The vehicle in front is bent out of shape
- The front vehicle's speed is fast or slow
- The vehicle in front steers in the opposite direction of your vehicle to avoid a collision
- With a vehicle in front, your vehicle changes lane at low speed
- The vehicle in front is covered with snow
- You are departing or returning to the lane
- You are driving unstably
- You are on a roundabout and the vehicle in front is not detected
- You are continuously driving in a circle
- The vehicle in front has an unusual shape
- The vehicle in front is driving uphill or downhill
- The pedestrian or cyclist is not fully detected, for example, if the pedestrian is leaning over or is not fully walking upright
- The pedestrian or cyclist is wearing clothing or equipment that makes it difficult to detect as a pedestrian or cyclist

Following image shows the image the sensor recognizes as vehicle, pedestrian, and cyclist.



- The pedestrian or cyclist in front is moving very quickly
- The pedestrian or cyclist in front is short or is posing a low posture
- The pedestrian or cyclist in front has impaired mobility
- The pedestrian or cyclist in front is moving intersected with the driving direction
- There is a group of pedestrians, cyclists or a large crowd in front
- The pedestrian or cyclist is wearing clothing that easily blends into the background, making it difficult to detect
- The pedestrian or cyclist is difficult to distinguish from the similar shaped structure in the surroundings
- You are driving by a pedestrian, cyclist traffic signs, structures, etc. near the intersection
- Driving in a parking lot
- Driving through a tollgate, construction area, unpaved road, partial paved road, uneven road, speed bumps, etc.
- Driving on an incline road, curved road, etc.

- Driving through a roadside with trees or streetlights
- The adverse road conditions cause excessive vehicle vibrations whilst driving
- Your vehicle height is low or high due to heavy loads, abnormal tyre pressure, etc.
- Driving through a narrow road where trees or grass or overgrown
- There is interference by electromagnetic waves, such as driving in an area with strong radio waves or electrical noise

⚠ WARNING

- **Driving on a curved road**

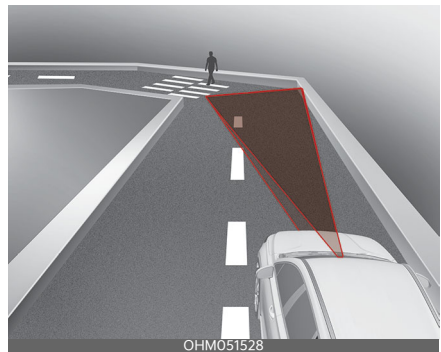
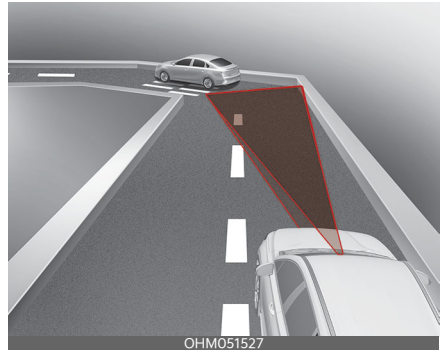

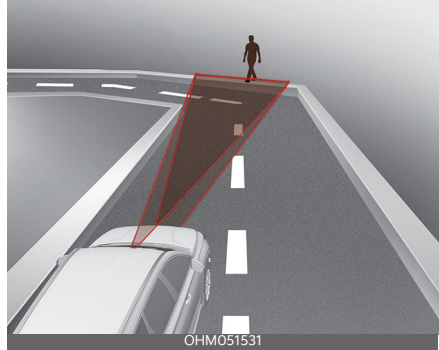
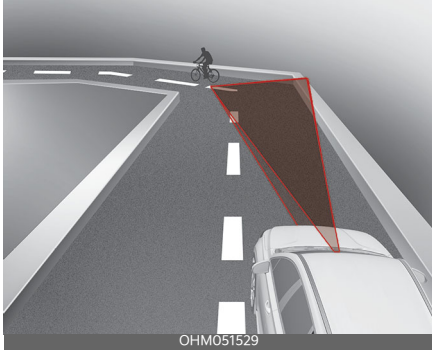

The front view camera or radar sensor recognition may not detect the vehicle, pedestrian or cyclist travelling in front on a curved road.

Always pay attention to road and driving conditions, and if necessary, depress the brake pedal to reduce your driving speed in order to maintain a safe distance.

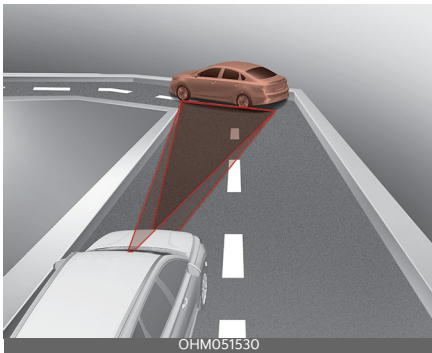
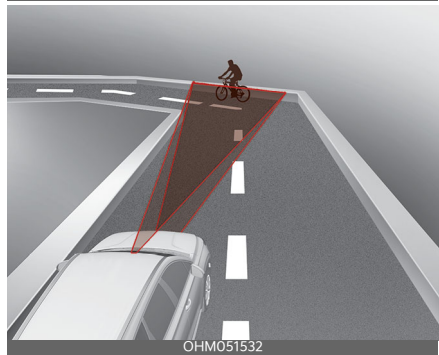

Forward Collision-Avoidance Assist may detect a vehicle or pedestrian in the next lane or outside the lane when driving on a curved road. If this occurs, the unnecessarily alarm the driver and apply the brake or steering wheel (if equipped). Always check the traffic conditions around the vehicle.

• **Driving on an inclined road**



Forward Collision-Avoidance Assist may not detect other vehicle, pedestrian or cyclist in front whilst driving uphill or downhill and this may result in no warning, braking assist or steering assist when necessary.

When the function suddenly recognizes the vehicle, pedestrian or cyclist in front whilst passing over a slope, you may experience sharp deceleration.

Always keep your eyes forward whilst driving upward or downward on a slope, and, if necessary, depress the brake pedal to reduce your driving speed in order to maintain distance.

• **Changing lanes**

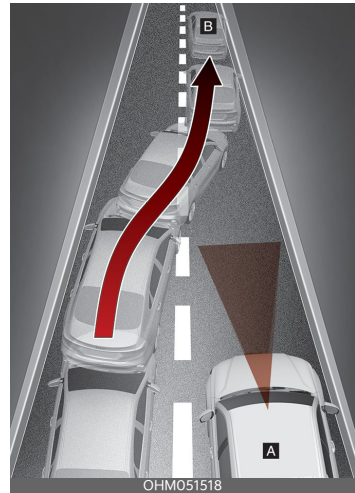

[A]: Your vehicle

[B]: Lane changing vehicle

When a vehicle changes lanes in front of you, FCA may not immediately detect the vehicle, especially if the vehicle changes lanes abruptly. In this case, you must maintain a safe braking distance, and if necessary, depress the brake pedal to reduce your driving speed in order to maintain a safe distance.

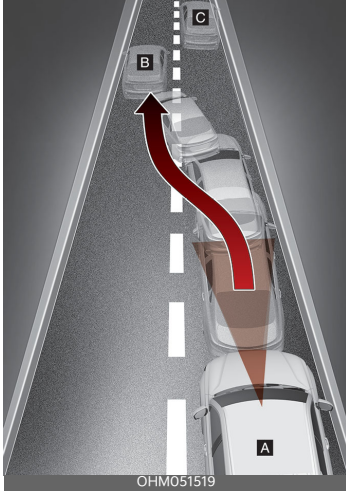

[A]: Your vehicle

[B]: Lane changing vehicle

[C]: Same lane vehicle

When driving in stop-and-go traffic, and a stopped vehicle in front of you merges out of the lane, FCA may not immediately detect the new vehicle that is now in front of you. In this case, you must maintain a safe braking distance, and if necessary, depress the brake pedal to reduce your driving speed in order to maintain a safe distance.

• **Detecting vehicle**

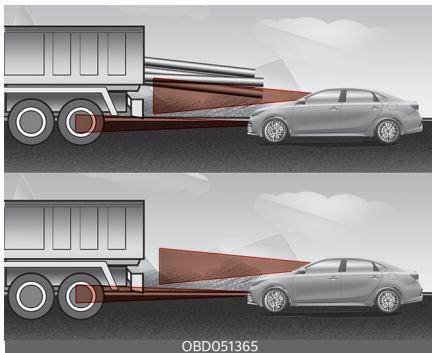

When the vehicle in front has heavy loading extended rearward, or when the vehicle in front has higher ground clearance, it may induce a hazardous situation. Always pay attention to road and driving conditions, whilst driving and, if necessary, depress the brake pedal to reduce your driving speed in order to maintain distance.

⚠ WARNING

- When you are towing a trailer or another vehicle, we recommend that Forward Collision-Avoidance Assist is turned off due to safety reasons.
- Forward Collision-Avoidance Assist may operate if objects that are similar in shape or characteristics to vehicles, pedestrians or cyclists are detected.
- Forward Collision-Avoidance Assist does not operate on bicycles, motorcycles, or smaller wheeled objects, such as luggage bags, shopping carts, or strollers that are dragged by a pedestrian or a cyclist.
- Forward Collision-Avoidance Assist may not operate normally if interfered by strong electromagnetic waves.
- Forward Collision-Avoidance Assist may not operate for 15 seconds after the vehicle is started, or the front view camera is initialized.

Lane Keeping Assist (LKA) (if equipped)



Lane Keeping Assist is designed to help detect the lane markers (or road edges) whilst driving over a certain speed. The function will warn the driver if the vehicle leaves the lane without using the turn signal, or will automatically assist the driver's steering to help prevent the vehicle from departing the lane.

Detecting sensor



[1]: Front view camera

The front view camera is used as a detecting sensor to detect lane markings (or road edges).

Refer to the picture above for the detailed location of the detecting sensor.

⚠ CAUTION

For more details on the precautions of the front view camera, refer to "Forward Collision-Avoidance Assist (FCA) (Sensor fusion) (if equipped)" on page 6-69.

Lane Keeping Assist settings

Lane safety



With the ignition switch or ENGINE START/STOP button in the ON position, select 'Driver assistance → Lane safety' from the 'User settings (LCD display) or Setup → Vehicle (Infotainment System screen)' menu to set whether or not to use each function.

- If 'Assist' is selected, the function will automatically assist the driver's steering when lane departure is detected to help prevent the vehicle from moving out of its lane.
- If 'Warning only' is selected, the function will warn the driver with an audible warning and steering wheel vibration when lane departure is detected. The driver must steer the vehicle.
- If 'Off' is selected, the function will turn off. The indicator light () will turn off on the cluster.

⚠ WARNING

- If 'Warning only' is selected, steering is not assisted.
- Lane Keeping Assist does not control the steering wheel when the vehicle is driven in the middle of the lane.
- The driver should always be aware of the surroundings and steer the vehicle if 'Off' is selected.

Turning Lane Keeping Assist ON/OFF



Whenever the vehicle is turned on, Lane Keeping Assist will always turn on. The grey () indicator light will appear on the cluster. When Lane Keeping Assist is on, press and hold the Lane Driving Assist button to turn off the function.

*** NOTICE**

When Lane Keeping Assist is turned off with the Lane Driving Assist button, Lane Safety settings will turn off.

Warning volume

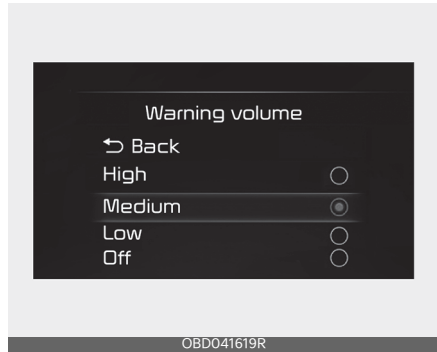

With the ignition switch or ENGINE START/STOP button in the ON position, select 'Driver assistance → Warning volume' from the 'User settings (LCD display) or Setup → Vehicle (Infotainment System screen)' menu to change the Warning Volume to 'High', 'Medium', 'Low' or 'Off' for Lane Keeping Assist. However, even if 'Off' is selected, the Hands-off Warning volume will not be turned off. Steering wheel vibration function will also remain on even if 'Off' is selected.

If you change the Warning volume, the Warning volume of other Driver Assistance functions may be changed.

*** NOTICE**

If your vehicle is equipped with additional Infotainment System, please scan the QR code in a separately supplied Car Infotainment System Quick Reference Guide.

Lane Keeping Assist operation

Warning and control

Lane Keeping Assist will warn and control the vehicle with Lane Departure Warning and Lane Keeping Assist.

Lane Departure Warning

Left



OBD041263

Right

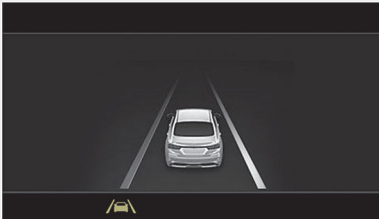

OBD041266

- To warn the driver that the vehicle is departing from the projected lane in front, the green () indicator light will blink on the cluster, the lane line will blink on the cluster depending on which direction the vehicle is veering, and an audible warning will sound. Also, the steering wheel will vibrate.
- The function will operate when your vehicle speed is between approximately 60~200 km/h (40~120 mph).

Lane Keeping Assist

- To warn the driver that the vehicle is departing from the projected lane in front, the green () indicator light will blink on the cluster, and the steering wheel will make adjustments to keep vehicle inside the lane.
- The function will operate when your vehicle speed is between approximately 60~200 km/h (40~120 mph).

Hands-off warning



OBD041236R

If the driver takes their hands off the steering wheel for several seconds, the 'Keep hands on steering wheel' warning message will appear on the cluster, and an audible warning will sound in stages.

WARNING

- The steering wheel may not be assisted if the steering wheel is held very tight or the steering wheel is steered over a certain degree.
- Lane Keeping Assist does not operate at all times. It is the responsibility of the driver to safely steer the vehicle and to maintain the vehicle in its lane.
- The hands-off warning message may appear late depending on road conditions. Always have your hands on the steering wheel whilst driving.

- If the steering wheel is held very lightly, the hands off warning message may appear because the function may not recognize that the driver has their hands on the steering wheel.
- If you attach objects to the steering wheel, the hands-off warning may not work properly.

*** NOTICE**

- For more details on setting the functions in the infotainment function, refer to "LCD display modes (for Type B cluster)" on page 4-62.
- When lane markings (or road edges) are detected, the lane lines on the cluster will change from gray to the green () indicator light will illuminate if LKA is operable.

Lane detected



OBD041268

- Even though the steering is assisted by Lane Keeping Assist, the driver may control the steering wheel.
- The steering wheel may feel heavier or lighter when the steering wheel is assisted by Lane Keeping Assist than when it is not.

Lane Keeping Assist malfunction and limitations

Lane Keeping Assist malfunction

Lane undetected

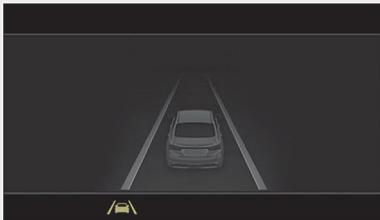

OBD041267

Check LKA (Lane Keep Assist) system



OMQ4050214R

When Lane Keeping Assist is not working properly, the 'Check LKA (Lane Keeping Assist) system', warning message will appear and the yellow  indicator light will illuminate on the cluster. If this occurs, have the function checked by a professional work-

shop. Kia recommends to visit an authorised Kia dealer/service partner.

Limitations of Lane Keeping Assist

Lane Keeping Assist may not operate normally or may operate unexpectedly under the following circumstances:

- The lane is contaminated or difficult to distinguish because,
 - The lane markings (or road edge) is covered with rain, snow, dirt, oil, etc.
 - The colour of the lane marking (or road edge) is not distinguishable from the road
 - There are markings (or road edges) on the road near the lane or the markings (or road edges) on the road looks similar to the lane markings (or road edge)
 - The lane marking (or road edge) is indistinct or damaged
 - The shadow is on the lane marking (or road edge) by a median strip, trees, guardrail, noise barriers, etc.
- There are more than two lane markings (or road edges) on the road
- The lane number increases or decreases, or the lane markings (or road edges) are crossing
- The lane markings (or road edges) are complicated or a structure substitutes for the lines, such as a construction area
- There are road markings, such as zig-zag lanes, crosswalk markings and road signs
- The lane suddenly disappears, such as at the intersection
- The lane (or road width) is very wide or narrow

- There is a road edge without a lane
- There is a boundary structure in the roadway, such as a tollgate, sidewalk, kerb, etc.
- The distance to the front vehicle is extremely short or the vehicle in front is covering the lane marking (or road edge)

For more details on the limitations of the front view camera, refer to "Forward Collision-Avoidance Assist (FCA) (Sensor fusion) (if equipped)" on page 6-69.

WARNING

Take the following precautions when using Lane Keeping Assist:

- The driver should hold the responsibility to safely drive and control the vehicle. Do not solely rely on the function and drive dangerously.
- The operation of Lane Keeping Assist can be cancelled or not work properly depending on road conditions and surroundings. Always be cautious whilst driving.
- Refer to "Limitations of Lane Keeping Assist" on page 6-85, if the lane is not detected properly.
- When you are towing a trailer or another vehicle, we recommend that Lane Keeping Assist is turned off due to safety reasons.
- If the vehicle is driven at high speed, the steering wheel will not be controlled. The driver must always follow the speed limit when using the function.
- If any other function's warning message is displayed or audible warning is generated, Lane Keeping Assist warning message may not be displayed and audible warning may not be generated.

- You may not hear the warning sound of Lane Keeping Assist if the surrounding is noisy.
- If you attach objects to the steering wheel, steering may not be assisted properly.
- Lane Keeping Assist may not operate for 15 seconds after the vehicle is started, or the front view camera is initialized.
- Lane Keeping Assist will not operate when:
 - The turn signal or hazard warning flasher is turned on
 - The vehicle is not driven in the centre of the lane when the function is turned on or right after changing a lane
 - ESC (Electronic Stability Control) or VSM (Vehicle Stability Management) is activated
 - The vehicle is driven on a sharp curve
 - Vehicle speed is below 55 km/h (35 mph) or above 210 km/h (130 mph)
 - The vehicle makes sharp lane changes
 - The vehicle is suddenly stopped

Blind-Spot Collision Warning (BCW) (if equipped)

Blind-Spot Collision Warning is designed to help detect and monitor approaching vehicles in the driver's blind spot area and warn the driver of a possible collision with a warning message and audible warning.

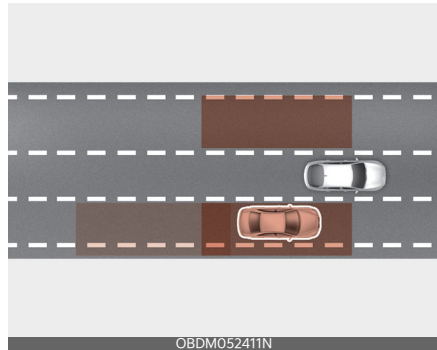

Blind-Spot Collision Warning help detects and informs the driver that a vehicle is in the blind spot.

CAUTION

The detecting range may vary depending on the speed of your vehicle. However, even if there is a vehicle in the blind spot, the function may not warn you when you pass by at high speed.

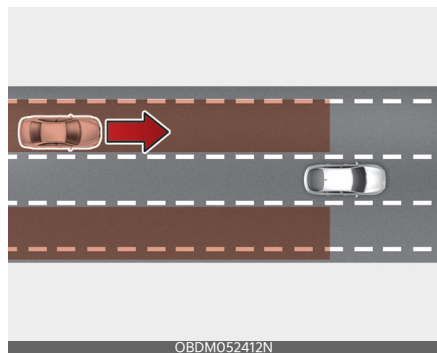

Blind-Spot Collision Warning help detects and informs the driver that a vehicle is approaching at high speed from the blind spot area.

⚠ CAUTION

Warning Timing may vary depending on the speed of the vehicle approaching at high speed.

Detecting sensor



[1]: Rear corner radar

Refer to the picture above for the detailed location of the detecting sensor.

⚠ CAUTION

- Never disassemble the rear corner radar or radar assembly, or apply any impact on it.
- If the rear corner radar have been replaced or repaired. In this case, have your vehicle inspected by a professional workshop. Kia recommends to contact an authorized Kia dealer/ service partner.
- If there is impact on the rear corner radar or near the radar, even though the warning message does not appear on the cluster, Blind-Spot Collision Warning may not operate properly. In

this case, have your vehicle inspected by a professional workshop. Kia recommends to contact an authorized Kia dealer/service partner.

- The genuine Kia rear bumpers which the Rear corner radar sensors are mounted are parts with quality and performance ensured. If arbitrarily applying paint on or changing the bumper, the Blind-Spot Collision-Avoidance Assist may not function properly. Use only Kia Genuine Parts or those of an equivalent standard with proven quality and performance to repair or replace the bumper.
- Do not apply license plate frame or object, such as a bumper sticker, film or a bumper guard near the rear corner radar.
- The function may not work properly if the bumper has been replaced, or the surroundings of the rear corner radar has been damaged or paint has been applied.
- If a trailer, carrier, etc. is installed, it may adversely affect the performance of the rear corner radar or the function may not operate.

Blind-Spot Collision Warning settings

Blind-spot safety



With the ignition switch or ENGINE START/STOP button in the ON position, select or deselect "User settings (LCD display) → Driver assistance → Blind-spot safety" to set whether or not to use each function.

If 'Warning only' is selected, the function will warn the driver with a warning message, an audible warning depending on the collision risk levels.

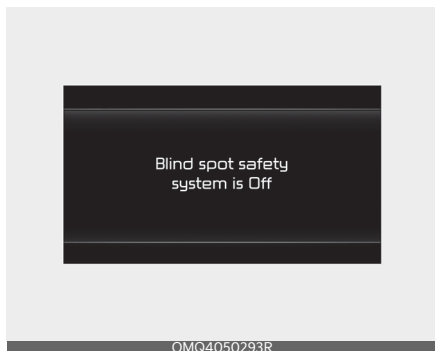

When the engine is restarted with Blind-Spot Collision Warning off, the 'Blind-spot safety system is off' message will appear on the cluster.

If you change the setting from 'Off' to 'Warning only', the warning light on the outside rearview mirror will blink for three seconds.

In addition, if the engine is turned on, when Blind-Spot Collision Warning is set to 'Warning only', the warning light on the outside rearview mirror will blink for three seconds.

WARNING

- If 'Warning only' is selected, steering is not assisted.
- If 'Off' is selected, the driver should always be aware of the surroundings and drive safely.

* NOTICE

If the engine is restarted, Blind-Spot Collision Warning will maintain the last setting.

Warning timing

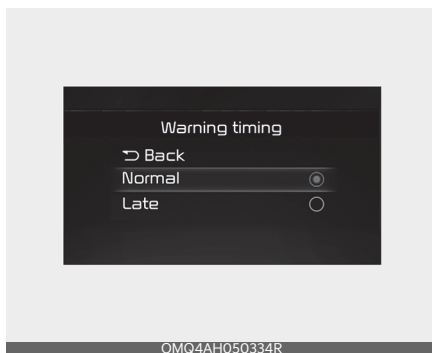

With the ignition switch or ENGINE START/STOP button in the ON position, select 'Driver assistance → Warning timing' from the 'User settings (LCD display)' to change the initial warning activation time for Blind-Spot Collision Warning.

When the vehicle is first delivered, Warning Timing is set to 'Normal'. If you change the Warning timing, the warning time of other Driver Assistance system may change.

Warning volume

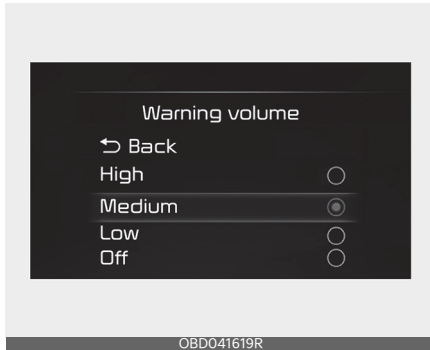

With the ignition switch or ENGINE START/STOP button in the ON position, select 'Driver assistance → Warning volume' from the 'User settings (LCD display)' to change the Warning volume to 'High', 'Medium', 'Low' or 'Off' (if equipped) for Blind-Spot Collision Warning.

If you change the Warning Volume, the warning volume of other Driver Assistance system may change.

CAUTION

- The setting of the Warning timing and Warning volume applies to all functions of Blind-Spot Collision Warning.
- Even though 'Normal' is selected for Warning Timing, if the vehicles approaches at high speed, the initial warning activation time may seem late.
- Select 'Late' for Warning Timing when traffic is light and when driving speed is slow.

* NOTICE

If your vehicle is equipped with additional Infotainment System, please scan the QR code in a separately supplied Car Infotainment System Quick Reference Guide.

Blind-Spot Collision Warning operation

Vehicle detection



- To warn the driver a vehicle is detected, the warning light on the outside rearview mirror and will illuminate
- Blind-Spot Collision Warning will operate when your vehicle speed is above 20 km/h (12 mph) and the speed of the vehicle in the blind spot area is above 10 km/h (7 mph).

Collision warning

- Collision Warning will operate when the turn signal is turned on in the direction of the detected vehicle.
- To warn the driver of a collision, the warning light on the outside rearview mirror will blink.
- When the turn signal is turned off or you move away from the lane, the Collision Warning will be cancelled

and Blind-Spot Collision Warning will return to vehicle detection state.

⚠ WARNING

- The detecting range of the rear corner radar is determined by the standard road width, therefore, on a narrow road, the function may detect other vehicles in the next lane and warn you. In contrast, on a wide road, the function may not be able to detect a vehicle driving in the next lane and may not warn you.
- When the hazard warning light is on, the Collision Warning by the turn signal will not operate.

Take the following precautions when using Blind-Spot Collision Warning:

- For your safety, change the Settings after parking the vehicle at a safe location.
- If any other function’s warning message is displayed or audible warning is generated, Blind-Spot Collision Warning’s warning message may not be displayed and audible warning may not be generated.
- You may not hear the warning sound of Blind-Spot Collision Warning if the surrounding is noisy. Blind-Spot Collision Warning may warn the driver late or may not warn the driver depending on the road and driving conditions.
- Driver should maintain control of the vehicle at all times. Do not depend on Blind-Spot Collision Warning. Maintain a safe braking distance, and if necessary, depress the brake pedal to reduce driving speed or to stop the vehicle.

Blind-Spot Collision Warning malfunction and limitations

Blind-Spot Collision Warning malfunction

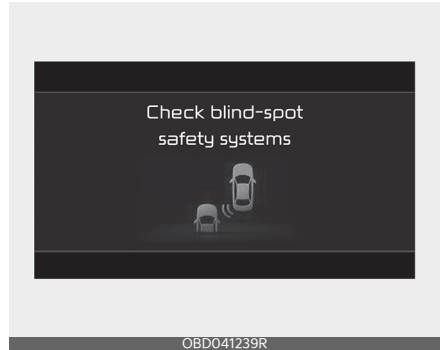

When Blind-Spot Collision Warning is not working properly, the 'Check blind-spot safety system' warning message will appear on the cluster, and the function will turn off automatically, or the function will be limited. In this case, have your vehicle inspected by a professional workshop. Kia recommends to contact an authorized Kia dealer/service partner.

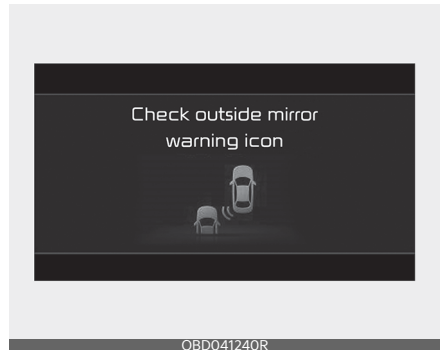

When the warning light on the side view mirror (outside mirror) is not working properly, the 'Check outside view mirror warning icon' warning message will appear on the cluster. We recommend

that you have your vehicle inspected by an authorized Kia dealer/service partner.

Blind-Spot Collision Warning disabled

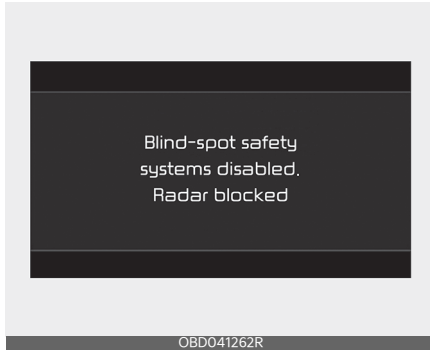

When the rear bumper around the rear corner radar or sensor is covered with foreign material, such as snow or rain, or installing a trailer or carrier, it can reduce the detecting performance and temporarily limit or disable Blind-Spot Collision Warning.

If this occurs, the 'Blind-spot safety system disabled. Radar blocked' warning message will appear on the cluster.

Blind-Spot Collision Warning will operate normally when such foreign material or trailer, etc. is removed, and then the engine is restarted.

If Blind-Spot Collision Warning does not operate normally after it is removed, have the vehicle inspected by a professional workshop. Kia recommends to visit an authorized Kia dealer/service partner.

⚠ WARNING

- Even though the warning message does not appear on the cluster, Blind-Spot Collision Warning may not properly operate.

- Blind-Spot Collision Warning may not properly operate in an area (e.g. open terrain), where any substance are not detected right after the engine is turned on, or when the detecting sensor is blocked with foreign material right after the engine is turned on.

⚠ CAUTION

Turn off Blind-Spot Collision Warning to install a trailer, carrier, etc., or remove the trailer, carrier, etc. to use Blind-Spot Collision Warning.

Limitations of Blind-Spot Collision Warning

Blind-Spot Collision Warning may not operate normally, or the function may operate unexpectedly under the following circumstances:

- There is inclement weather, such as heavy snow, heavy rain, etc.
- The rear corner radar is covered with snow, rain, dirt, etc.
- The temperature around the rear corner radar is high or low
- Driving on a highway (or motorway) ramp
- The road pavement (or the peripheral ground) abnormally contains metallic components (i.e. possibly due to subway construction).
- There is a fixed object near the vehicle, such as sound barriers, guardrails, central dividers, entry barriers, street lamps, signs, tunnels, walls, etc. (including double structures)
- Driving in large areas where there are few vehicles or structures (i.e. desert, meadow, suburb, etc.) Driving through a narrow road where trees or grass are overgrown

- Driving on a wet road surface, such as a puddle on the road
- The other vehicle drives very close behind your vehicle, or the other vehicle passes by your vehicle in close proximity
- The speed of the other vehicle is very fast that it passes by your vehicle in a short time
- Your vehicle passes by the other vehicle
- Your vehicle change lane
- Your vehicle has started at the same time as the vehicle next to you and has accelerated
- The vehicle in the next lane moves two lanes away from you, or when the vehicle two lanes away moves to the next lane from you
- A trailer or carrier is installed around the rear corner radar
- The bumper around the rear corner radar is covered with objects, such as a bumper sticker, bumper guard, bike rack, etc.
- The bumper around the rear corner radar is impacted, damaged or the radar is out of position
- Your vehicle height is low or high due to heavy loads, abnormal tyre pressure, etc.

Blind-Spot Collision Warning may not operate normally, or the function may operate unexpectedly when the following objects are detected:

- A motorcycle or bicycle is detected
- A vehicle such as a flat trailer is detected
- A big vehicle such as a bus or truck is detected

- A moving obstacle such as a pedestrian, animal, shopping cart or a baby stroller is detected
- A vehicle with low height such as a sports car is detected

⚠ WARNING

Driving on a curved road

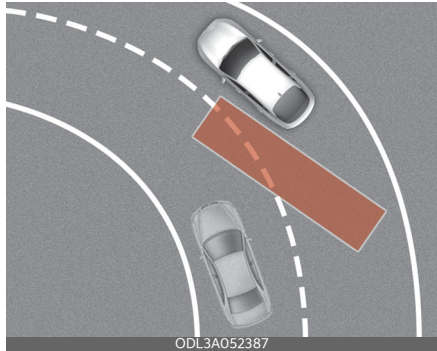

Blind-Spot Collision Warning may not operate properly when driving on a curved road. The function may not detect the vehicle in the next lane. Always pay attention to road and driving conditions whilst driving.

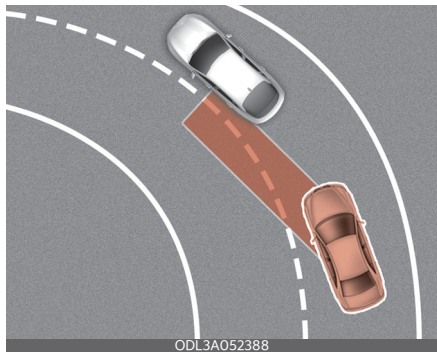

Blind-Spot Collision Warning may not operate properly when driving on the curved road. The function may recognize the vehicle in the same lane.

Always pay attention to road and driving conditions whilst driving.

Driving where the road is merging/dividing

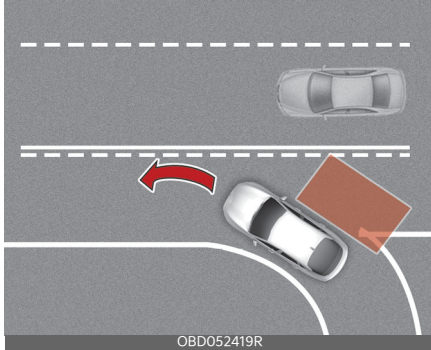

Blind-Spot Collision Warning may not operate properly when driving where the road merges or divides. The function may not detect the vehicle in the next lane.

Always pay attention to road and driving conditions whilst driving.

Driving on a sloped road

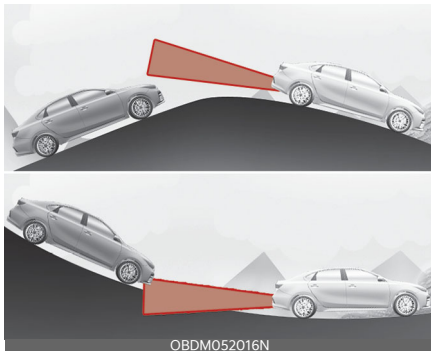

Blind-Spot Collision Warning may not operate properly when driving on a sloped road. The function may not detect the vehicle in the next lane or may incorrectly detect the ground or structure.

Always pay attention to road and driving conditions whilst driving.

Driving where the heights of the lanes are different

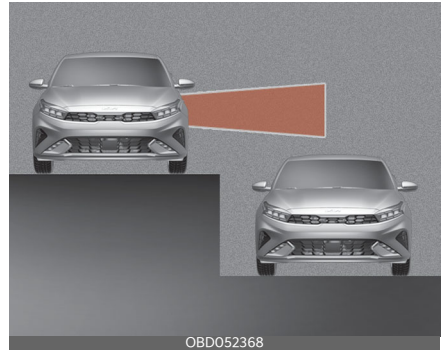

Blind-Spot Collision Warning may not operate properly when driving where the heights of the lanes are different. The function may not detect the vehicle on a road with different lane heights (under-pass joining section, grade separated intersections, etc.).

Always pay attention to road and driving conditions whilst driving.

⚠ WARNING

Blind-Spot Collision Warning may not operate normally if interfered by strong electromagnetic waves.

Blind-Spot Collision Warning may not operate for 3 seconds after the vehicle is started, or the rear corner radars are initialized.

Blind-Spot Collision-Avoidance Assist (BCA) (if equipped)

Blind-Spot Collision-Avoidance Assist is designed to help detect and monitor approaching vehicles in the driver's blind spot area and warn the driver of a possible collision with a warning message and audible warning.

In addition, if there is a risk of collision when changing lanes or driving forward out of a parking space, the function will help avoid collision by applying the differential braking.

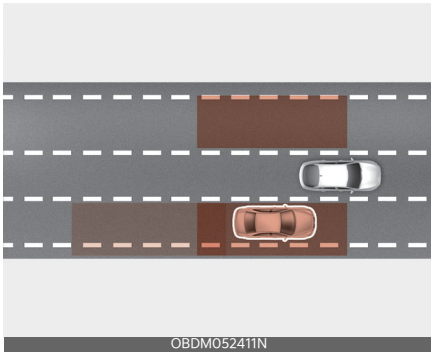

Blind-Spot Collision-Avoidance Assist help detects and informs the driver that a vehicle is in the blind spot.

⚠ CAUTION

The detecting range may vary depending on the speed of your vehicle. However, even if there is a vehicle in the blind spot, the function may not warn you when you pass by at high speeds.

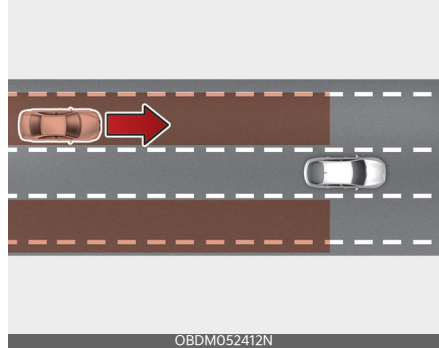

Blind-Spot Collision-Avoidance Assist help detects and informs the driver that a vehicle is approaching at high speed from the blind spot area.

⚠ CAUTION

Warning timing may vary depending on the speed of the vehicle approaching at high speed.

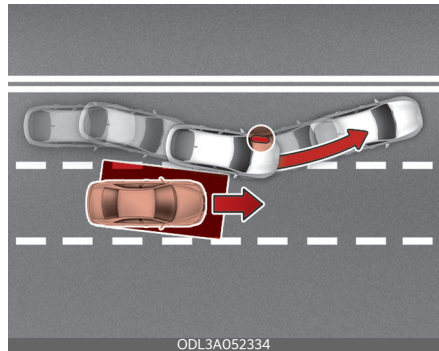

When you are driving forward out of a parking space, if the function judges that there is a collision risk with an approaching vehicle in the blind spot, the function will help avoid collision by applying the brake.

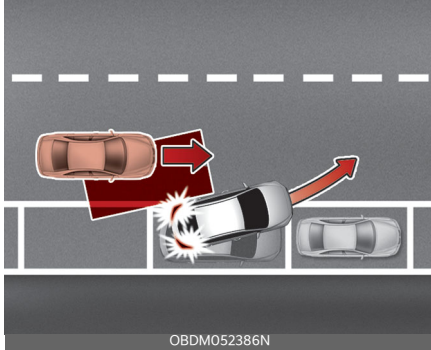

When changing lanes by detecting the lane ahead, if the function judges that there is a collision risk with an approaching vehicle in the blind spot, the function will help avoid collision by applying the differential brake.

Detecting sensor



[1] : Front view camera, [2] : Rear corner radar

Refer to the picture above for the detailed location of the detecting sensors.

⚠ CAUTION

Take the following precautions to maintain optimal performance of the detecting sensor:

- Never disassemble the rear corner radar or radar assembly, or apply any impact on it.
- If there is impact on the rear corner radar or near the radar, even though the warning message does not appear on the cluster, Blind-Spot Collision-Avoidance Assist may not operate properly. In this case, have your vehicle inspected by a professional workshop. Kia recommends to contact an authorised Kia dealer/service partner.
- If the rear corner radars have been replaced or repaired, In this case, have your vehicle inspected by a professional workshop. Kia recommends to contact an authorised Kia dealer/service partner.

⚠ CAUTION

- The genuine Kia rear bumpers which the Rear corner radar sensors are mounted are parts with quality and performance ensured. If arbitrarily applying paint on or changing the bumper, the Blind-Spot Collision-Avoidance Assist may not function properly. Use only Kia Genuine Parts or those of an equivalent standard with proven quality and performance to repair or replace the bumper.
- Do not apply license plate frame or objects, such as a bumper sticker, film

or a bumper guard near the rear corner radar.

- The function may not work properly if the bumper has been replaced, or the surroundings of the rear corner radar has been damaged or paint has been applied.
- If a trailer, carrier, etc. is installed, it may adversely affect the performance of the rear corner radar or the function may not operate.

For more details on the precautions of the front view camera, refer to "Forward Collision-Avoidance Assist (FCA) (Sensor fusion) (if equipped)" on page 6-69.

Blind-Spot Collision-Avoidance Assist settings

Blind-spot safety

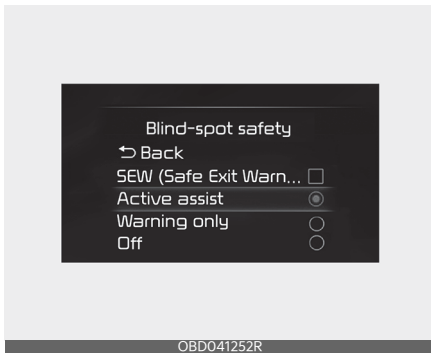

With the ignition switch or ENGINE START/STOP button in the ON position, select 'Driver assistance → Blind-spot safety' from the 'User settings (LCD display) or Setup → Vehicle (Infotainment System screen)' menu to set whether or not to use each function.

- If 'Active assist' is selected, the function will warn the driver with a warning message, an audible warning, steering wheel vibration and braking

assist will be applied depending on the collision risk levels.

- If 'Warning only' is selected, the function will warn the driver with a warning message, an audible warning and steering wheel vibration depending on the collision risk levels. Braking will not be assisted.



When the engine is restarted with the function off, the 'Blind spot safety system is Off' message will appear on the cluster.

If you change the setting from 'Off' to 'Active assist' or 'Warning only', the warning light on the side view mirror (outside mirror) will blink for approximately 3 seconds.

In addition, if the engine is turned on, when the function is set to 'Active assist' or 'Warning Only', the warning light on the side view mirror (outside mirror) will blink for approximately 3 seconds.

WARNING

- If 'Warning only' is selected, braking is not assisted.
- If 'Off' is selected, the driver should always be aware of the surroundings and drive safely.

*** NOTICE**

If the engine is restarted, Blind-Spot Collision-Avoidance Assist will maintain the last setting.

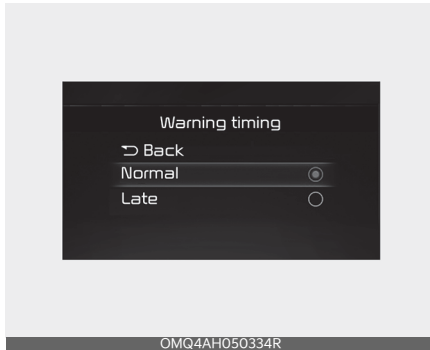
Warning timing

With the ignition switch or ENGINE START/STOP button in the ON position, select 'Driver assistance → Warning timing' from the 'User settings (LCD display) or Setup → Vehicle (Infotainment System screen)' menu to change the initial warning activation time for Blind-Spot Collision-Avoidance Assist.

When the vehicle is first delivered, Warning Timing is set to 'Normal'. If you change the Warning timing, the warning time of other Driver Assistance functions may change.

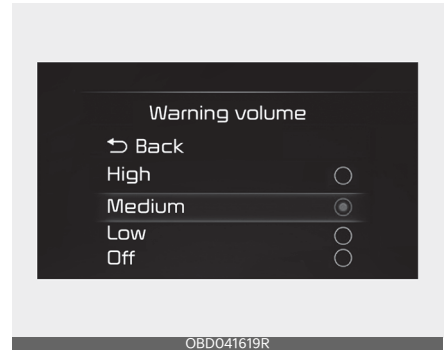
Warning volume

With the ignition switch or ENGINE START/STOP button in the ON position, select 'Driver assistance → Warning volume' from the 'User settings (LCD display) or Setup → Vehicle (Infotainment System screen)' menu to change the Warning volume to 'High', 'Medium', 'Low' or 'Off' (if equipped) for Blind-Spot Collision-Avoidance Assist. However, when Warning volume is turned Off, the steering wheel vibration function will turn on if it was turned Off.

If you change the Warning volume, the warning volume of other Driver Assistance functions may change.

⚠ CAUTION

- The setting of the Warning timing and Warning volume applies to all functions of the Blind-Spot Collision-Avoidance Assist.
- Even though 'Normal' is selected for Warning timing, if the vehicle approaches at high speed, the initial warning activation time may seem late.
- Select 'Late' for Warning Timing when traffic is light and when driving speed is slow.

*** NOTICE**

If your vehicle is equipped with additional Infotainment System, please scan the QR code in a separately supplied Car Infotainment System Quick Reference Guide.

Blind-Spot Collision-Avoidance Assist operation

Warning and control

Vehicle detection



- To warn the driver a vehicle is detected, the warning light on the side view mirror (outside mirror) will illuminate.
- The function will operate when your vehicle speed is above 20 km/h (12 mph) and the speed of the vehicle in the blind spot area is above 10 km/h (7 mph).

Collision warning

- Collision warning will operate when the turn signal is turned on in the direction of the detected vehicle.
- If 'Warning only' is selected from the settings menu, the collision warning will operate when your vehicle approaches the lane the blind spot vehicle is detected.

- To warn the driver of a collision, the warning light on the side view mirror (outside mirror) will blink.
- When the turn signal is turned off or you move away from the lane, the collision warning will be cancelled and the function will return to vehicle detection state.

⚠ WARNING

- The detecting range of the rear corner radar is determined by a standard road width, therefore, on a narrow road, the function may detect other vehicles in the second lane from your vehicle and warn you.
- In contrast, on a wide road, the function may not be able to detect a vehicle driving in the next lane and may not warn you.
- When the hazard warning light is on, the collision warning by the turn signal will not operate.

*** NOTICE**

If the driver's seat is on the left side, the collision warning may occur when you turn left. Maintain a proper distance with the vehicles in the left lane. If the driver's seat is on the right side, the collision warning may occur when you turn right. Maintain a proper distance with the vehicles in the right lane.

Collision-Avoidance Assist (whilst driving)

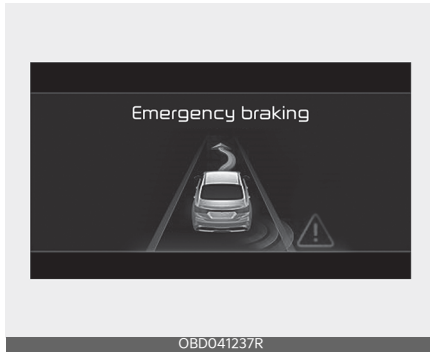

- To warn the driver of a collision, the warning light on the side view mirror (outside mirror) will blink and a warning message will appear on the cluster.
- The function will operate when your vehicle speed is between 60~200 km/h (40~120 mph) and both lane markings of the driving lane are detected.
- Emergency braking will be assisted to help prevent collision with the vehicle in the blind spot area.

WARNING

- Collision-Avoidance Assist will be cancelled under the following circumstances:
 - Your vehicle enters the next lane by a certain distance
 - Your vehicle is away from the collision risk
 - The steering wheel is sharply steered
 - The brake pedal is depressed
 - Forward Collision-Avoidance Assist is operating
- After function operation or changing lane, you must drive to the centre of

the lane. The function will not operate if the vehicle is not driven in the centre of the lane.

Collision-Avoidance Assist (whilst departing)

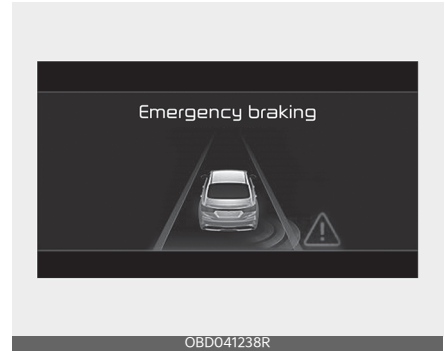

- To warn the driver of a collision, the warning light on the side view mirror (outside mirror) will blink and a warning message will appear on the cluster.
- The function will operate when your vehicle speed is below 3 km/h (2 mph) and the speed of the vehicle in the blind spot area is above 5 km/h (3 mph).
- Emergency braking will be assisted to help prevent collision with the vehicle in the blind spot area.

Stopping vehicle and ending brake control



- When the vehicle is stopped due to emergency braking, the 'Drive carefully' warning message will appear on the cluster.
- For your safety, the driver should depress the brake pedal immediately and check the surroundings.
- Brake control will end after the vehicle is stopped by emergency braking for approximately 2 seconds.

⚠ WARNING

- For your safety, change the settings after parking the vehicle at a safe location.
- If any other function's warning message is displayed or audible warning is generated, Blind-Spot Collision-Avoidance Assist warning message may not be displayed and audible warning may not be generated.
- You may not hear the warning sound of Blind-Spot Collision-Avoidance Assist if the surrounding is noisy.
- Blind-Spot Collision-Avoidance Assist may not operate if the driver applies the brake pedal to avoid collision.
- When Blind-Spot Collision-Avoidance Assist is operating, braking control by

the function will automatically cancel when the driver excessively depresses the accelerator pedal or sharply steers the vehicle.

- If changing the gear quickly during reversing the vehicle, Blind-Spot Collision-Avoidance Assist may not work or may operate unnecessarily.
- During Blind-Spot Collision-Avoidance Assist operation, the vehicle may stop suddenly injuring passengers and shifting loose objects. Always have the seat belt on and keep loose objects secured.
- Even if there is a problem with Blind-Spot Safety system, the vehicle's basic braking performance will operate normally.
- Blind-Spot Collision-Avoidance Assist does not operate in all situations or cannot avoid all collisions.
- Blind-Spot Collision-Avoidance Assist may warn the driver late or may not warn the driver depending on the road and driving conditions.
- Driver should maintain control of the vehicle at all times. Do not depend on Blind-Spot Collision-Avoidance Assist. Maintain a safe braking distance, and if necessary, depress the brake pedal to reduce driving speed or to stop the vehicle.
- Never operate Blind-Spot Collision-Avoidance Assist on people, animal, objects, etc. It may cause serious injury or death.

⚠ WARNING

The brake control may not operate properly depending on the status of ESC (Electronic Stability Control).

There will only be a warning when:

- The ESC (Electronic Stability Control) warning light is on.
- ESC (Electronic Stability Control) is engaged in a different function.

Blind-Spot Collision-Avoidance Assist malfunction and limitations

Blind-Spot Collision-Avoidance Assist malfunction

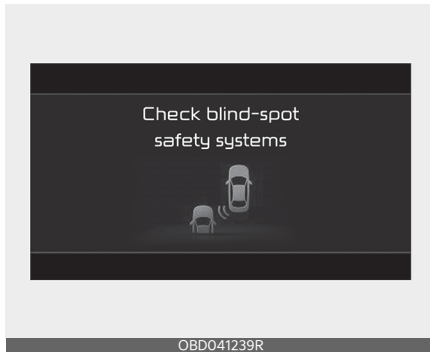

When Blind-Spot Collision-Avoidance Assist is not working properly, the 'Check blind-spot safety systems' warning message will appear (turns off after a certain time), and  warning light will illuminate on the cluster. In this case, have your vehicle inspected by a professional workshop. Kia recommends to contact an authorised Kia dealer/service partner.

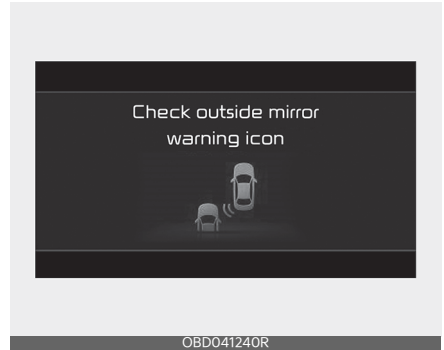

When the warning light on the side view mirror (outside mirror) is not working properly, the 'Check outside view mirror warning icon' warning message will appear (turns off after a certain time), and  warning light will illuminate on the cluster. We recommend that you have your vehicle inspected by an authorised Kia dealer/service partner.

Blind-Spot Collision-Avoidance Assist disabled

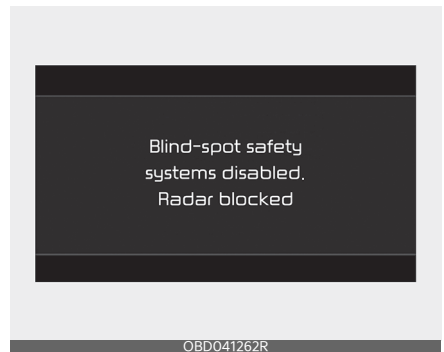

When the rear bumper around the rear corner radar or sensor is covered with foreign material, such as snow or rain, or installing a trailer or carrier, it can reduce the detecting performance and temporarily limit or disable Blind-Spot Collision-Avoidance Assist.

If this occurs, the 'Blind-spot safety system disabled. Radar blocked' warning message will appear on the cluster.

The function will operate normally when such foreign material or trailer, etc. is removed, and then the engine is restarted.

If the function does not operate normally after it is removed, have the vehicle inspected by a professional workshop. Kia recommends to visit an authorised Kia dealer/service partner.

⚠ WARNING

- Even though the warning message does not appear on the cluster, Blind-Spot Collision-Avoidance Assist may not properly operate.
- Blind-Spot Collision-Avoidance Assist may not properly operate in an area (e.g. open terrain), where any substance are not detected right after the engine is turned on, or when the detecting sensor is blocked with foreign material right after the engine is turned on.

⚠ CAUTION

Turn off Blind-Spot Collision-Avoidance Assist to install a trailer, carrier, etc., or remove the trailer, carrier, etc. to use Blind-Spot Collision-Avoidance Assist.

Limitations of Blind-Spot Collision-Avoidance Assist

Blind-Spot Collision-Avoidance Assist may not operate normally, or the function may operate unexpectedly under the following circumstances:

- There is inclement weather, such as heavy snow, heavy rain, etc.

- The rear corner radar is covered with snow, rain, dirt, etc.
- The temperature around the rear corner radar is high or low
- Driving on a highway (or motorway) ramp
- The road pavement (or the peripheral ground) abnormally contains metallic components (i.e. possibly due to subway construction).
- There is a fixed object near the vehicle, such as sound barriers, guardrails, central dividers, entry barriers, street lamps, signs, tunnels, walls, etc. (including double structures)
- Driving in large areas where there are few vehicles or structures (i.e. desert, meadow, suburb, etc.)
- Driving through a narrow road where trees or grass are overgrown
- Driving on a wet road surface, such as a puddle on the road
- The other vehicle drives very close behind your vehicle, or the other vehicle passes by your vehicle in close proximity
- The speed of the other vehicle is very fast that it passes by your vehicle in a short time
- Your vehicle passes by the other vehicle
- Your vehicle change lane
- Your vehicle has started at the same time as the vehicle next to you and has accelerated
- The vehicle in the next lane moves two lanes away from you, or when the vehicle two lanes away moves to the next lane from you
- A trailer or carrier is installed around the rear corner radar

- The bumper around the rear corner radar is covered with objects, such as a bumper sticker, bumper guard, bike rack, etc.
- The bumper around the rear corner radar is impacted, damaged or the radar is out of position
- Your vehicle height is low or high due to heavy loads, abnormal tyre pressure, etc.

Blind-Spot Collision-Avoidance Assist may not operate normally, or the function may operate unexpectedly when the following objects are detected:

- A motorcycle or bicycle is detected
- A vehicle such as a flat trailer is detected
- A big vehicle such as a bus or truck is detected
- A moving obstacle such as a pedestrian, animal, shopping cart or a baby stroller is detected
- A vehicle with low height such as a sports car is detected

Braking control may not work, driver's attention is required in the following circumstances:

- The vehicle severely vibrates when driving on a bumpy, uneven or concrete road
- Driving on a slippery surface due to snow, water puddle, ice, etc.
- The tyre pressure is low or a tyre is damaged
- The brake is reworked
- The vehicle makes abrupt lane changes

*** NOTICE**

For more details on the limitations of the front view camera, refer to "Forward Col-

lision-Avoidance Assist (FCA) (Sensor fusion) (if equipped)" on page 6-69.

⚠ WARNING

Driving on a curved road

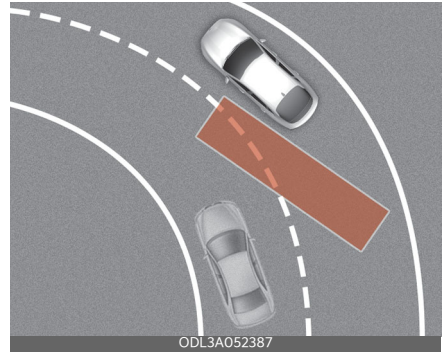

Blind-Spot Collision-Avoidance Assist may not operate properly when driving on a curved road. The function may not detect the vehicle in the next lane.

Always pay attention to road and driving conditions whilst driving.

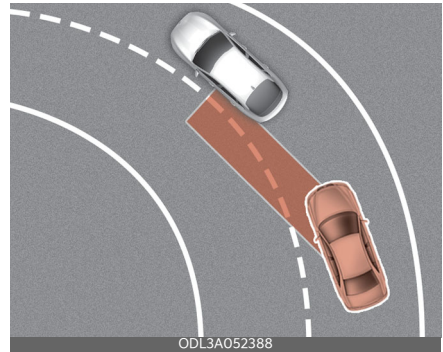

Blind-Spot Collision-Avoidance Assist may not operate properly when driving on the curved road. The function may recognize the vehicle in the same lane.

Always pay attention to road and driving conditions whilst driving.

Driving where the road is merging/dividing

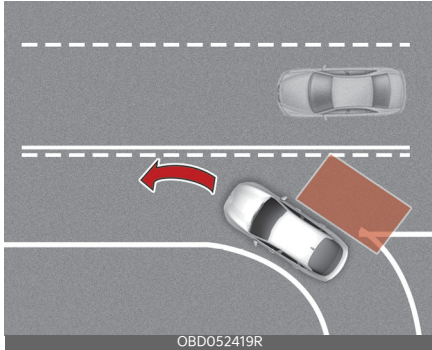

Blind-Spot Collision-Avoidance Assist may not operate properly when driving where the road merges or divides. The function may not detect the vehicle in the next lane. Always pay attention to road and driving conditions whilst driving.

Driving on an inclined road

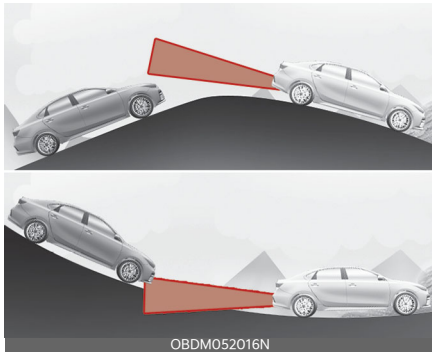

Blind-Spot Collision-Avoidance Assist may not operate properly when driving on a slope. The function may not detect the vehicle in the next lane or may incorrectly detect the ground or structure. Always pay attention to road and driving conditions whilst driving.

Driving where the heights of the lanes are different

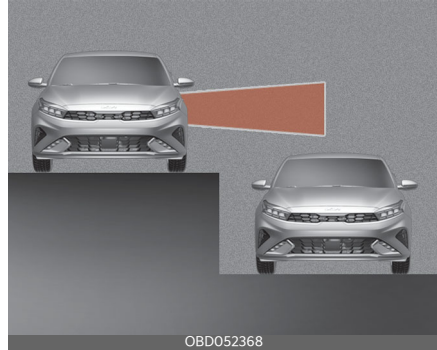

Blind-Spot Collision-Avoidance Assist may not operate properly when driving where the heights of the lanes are different. The function may not detect the vehicle on a road with different lane heights (underpass joining section, grade separated intersections, etc.). Always pay attention to road and driving conditions whilst driving.

WARNING

- When you are towing a trailer or another vehicle, make sure that you turn off Blind-Spot Collision-Avoidance Assist.
- Blind-Spot Collision-Avoidance Assist may not operate normally if interfered by strong electromagnetic waves.
- Blind-Spot Collision-Avoidance Assist may not operate for 15 seconds after the vehicle is started, or the rear corner radars are initialized.

Manual Speed Limit Assist (MSLA) (if equipped)



- (1) Speed Limit indicator
- (2) Set speed

You can set the speed limit when you do not want to drive over a specific speed. If you drive over the preset speed limit, Manual Speed Limit Assist will operate (set speed limit will blink and chime will sound) until the vehicle speed returns within the speed limit.

Manual Speed Limit Assist operation

Setting the speed limit

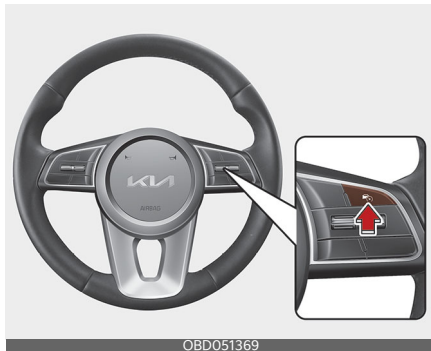

1. Press and hold the Driving Assist button on the steering wheel, at the

- desired speed. The Speed Limit indicator will illuminate on the cluster.
2. Push the + switch up or - switch down, and release it at the desired speed.

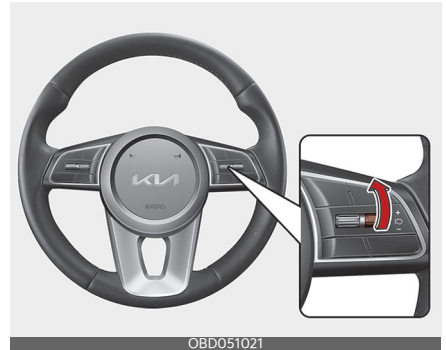

Push the + switch up or - switch down and hold it. The speed will increase or decrease to the nearest multiple of ten (multiple of five in mph) at first, and then increase or decrease by 10 km/h (5 mph).



3. The set speed limit will be displayed on the cluster. If you would like to drive over the preset speed limit, depress the accelerator pedal beyond the pressure point to activate the kick-down mechanism.



The set speed limit will blink and chime will sound until you return the vehicle speed within the speed limit.

*** NOTICE**

When the accelerator pedal is not depressed beyond the pressure point, vehicle speed will maintain within the speed limit.

Temporarily pausing Manual Speed Limit Assist



Press the   switch to temporarily pause the set speed limit. The set speed limit will turn off but the Speed Limit indicator will stay on.

Resuming Manual Speed Limit Assist

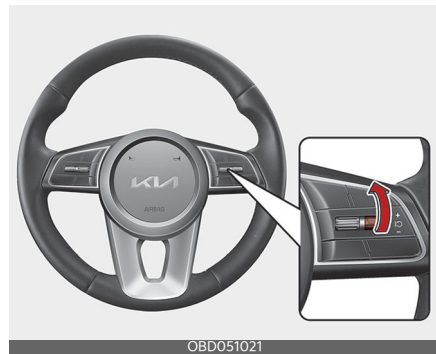

To resume Manual Speed Limit Assist after the function was paused, push the + switch up or - switch down.

Turning off Manual Speed Limit Assist



Press the Driving Assist button to turn Manual Speed Limit Assist off. The Speed Limit indicator will go off. Always press the Driving Assist button to turn Manual Speed Limit Assist off when not in use.

⚠ WARNING

Take the following precautions when using Manual Speed Limit Assist:

- Always set the vehicle speed to the speed limit in your country.
- Keep Manual Speed Limit Assist off when the function is not in use, to avoid inadvertently setting a speed. Check that the Speed Limit indicator is off.
- Manual Speed Limit Assist does not substitute for proper and safe driving. It is the responsibility of the driver to always drive safely and should always be aware of unexpected and sudden situations from occurring. Pay attention to the road conditions at all times.

Driver Attention Warning (DAW) (if equipped)

Basic function

Driver Attention Warning will determine the driver's attention level by analyzing driving pattern, driving time, etc. whilst driving. The function will recommend a break when the driver's attention level falls below a certain level to help drive safely.

Leading Vehicle Departure Alert

Leading Vehicle Departure Alert will inform the driver when the front vehicle departs from a stop.

Detecting sensor



[1]: Front view camera

The front view camera is used as a detecting sensor to detect driving patterns and front vehicle departure whilst vehicle is being driven.

Refer to the picture above for the detailed location of the detecting sensor.

⚠ CAUTION

Always keep the front view camera in good condition to maintain optimal performance of Driver Attention Warning. For more details on the precautions of the front view camera, refer to "Forward Collision-Avoidance Assist (FCA) (Sensor fusion) (if equipped)" on page 6-69.

Driver Attention Warning settings

Driver Attention Warning

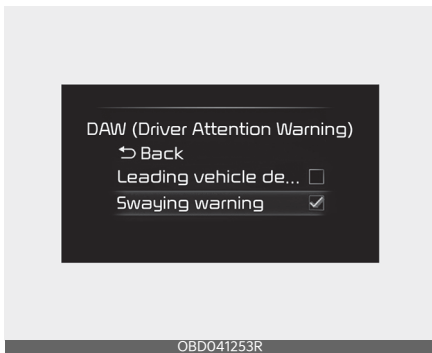

- With the ignition switch or ENGINE START/STOP button in the ON position, select 'Driver assistance → DAW (Driver Attention Warning)' from the 'User settings (LCD display) or Setup → Vehicle (Infotainment System screen)' menu to set whether or not to use each function.
- If 'Swaying warning' is selected, the function will inform the driver the driver's attention level and will recommend taking a break when the level falls below a certain level.

*** NOTICE**

If the engine is restarted, Inattentive Driving Warning will maintain the last setting.

Leading vehicle departure alert



If Leading vehicle departure alert is selected, the function will inform the driver when the front vehicle departs from a stop.

Warning timing



With the ignition switch or ENGINE START/STOP button in the ON position, select 'Driver assistance → Warning timing' from the 'User settings (LCD display) or Setup → Vehicle (Infotainment System screen)' menu to change the initial

warning activation time for Driver Attention Warning. When the vehicle is first delivered, warning timing is set to 'Normal'. If you change the warning timing, the warning time of other Driver Assistance functions may change. Make sure to check the warning timing before changing it.

*** NOTICE**

If the engine is restarted, Warning Timing will maintain the last setting.

*** NOTICE**

If your vehicle is equipped with additional Infotainment System, please scan the QR code in a separately supplied Car Infotainment System Quick Reference Guide.

Driver Attention Warning operation

Basic function

Display and warning

The basic function of Driver Attention Warning is to inform the driver the 'Attention Level' and to warn the driver 'Consider taking a break'.

Attention level

Off



Standby

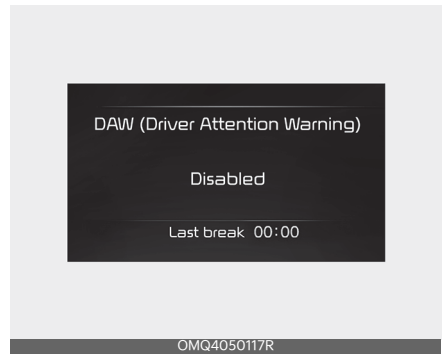

Attentive driving

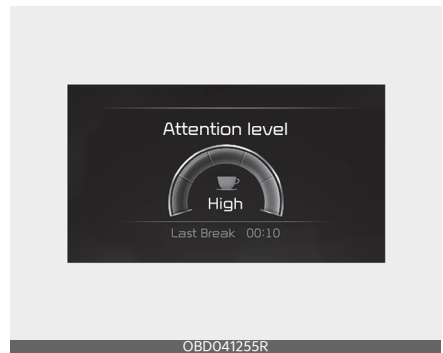

6

Inattentive driving



- The driver can monitor his/her driving conditions on the cluster.
 - When the 'Swaying warning' is deselected from the settings menu, 'System Off' is displayed.
 - The function will operate when vehicle speed is between 0~210 km/h (0~130 mph).
 - When vehicle speed is not within the operating speed, the message 'Standby' will be displayed.
- The driver's attention level is displayed on the scale of 1 to 5. The lower the level is, the more inattentive the driver is.
- The level decreases when the driver does not take a break for a certain period of time.

Taking a break

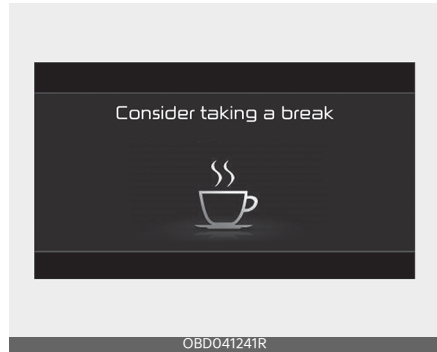

- The 'Consider taking a break' message will appear on the cluster and an audible warning will sound to suggest that the driver take a break, when the driver's attention level is below 1.
- Driver Attention Warning will not suggest a break when the total driving time is shorter than 10 minutes or 10 minutes has not passed after the last break was suggested.

WARNING

For your safety, change the settings after parking the vehicle at a safe location.

CAUTION

- Driver Attention Warning may suggest a break depending on the driver's driving pattern or habits, even if the driver doesn't feel fatigue.
- Driver Attention Warning is a supplemental function and may not be able to determine whether the driver is inattentive.
- The driver who feels fatigued should take a break at a safe location, even though there is no break suggestion by Driver Attention Warning.

*** NOTICE**

- For more details on setting the functions in the infotainment system, refer to "Instrument cluster" on page 4-52.
- Driver Attention Warning will reset the last break time to 00:00 in the following situations:
 - The engine is turned off
 - The driver unfastens the seat belt and opens the driver's door.
 - The vehicle is stopped for more than 10 minutes.
- When the driver resets Driver Attention Warning, the last break time is set to 00:00 and the driver's attention level is set to High.

Leading Vehicle Departure Alert

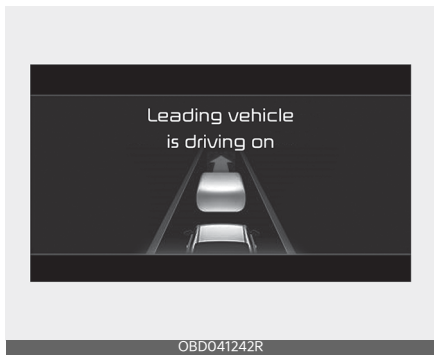

When the front vehicle departs from a stop, Leading Vehicle Departure Alert will inform the driver by displaying the 'Leading vehicle is driving on' message on the cluster and an audible warning will sound.

⚠ WARNING

- If any other function's warning message is displayed or audible warning is generated, Leading Vehicle Departure

Alert Warning message may not be displayed and audible warning may not be generated.

- The driver should hold the responsibility to safely drive and control the vehicle.

⚠ CAUTION

- Leading Vehicle Departure Warning is a supplemental function and may not warn the driver whenever the front vehicle departs from a stop.
- Always check the front of the vehicle and road conditions before departure.

Driver Attention Warning malfunction and limitations

Driver Attention Warning malfunction

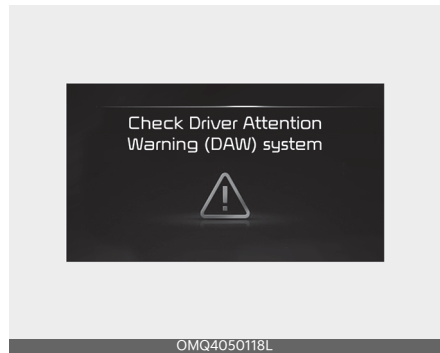

When Driver Attention Warning is not working properly, the 'Check Driver Attention Warning (DAW) system' warning message will appear on the cluster (turns off after a certain time) and ⚠ warning light will illuminate. If this occurs, we recommend that the function be inspected by an authorised Kia dealer/service partner.

Limitations of the function

Driver Attention Warning may not work properly in the following situations:

- The vehicle is driven violently
- The vehicle intentionally crosses over lanes frequently
- The vehicle is controlled by Driver Assistance function, such as Lane Keeping Assist.

Leading Vehicle Departure Alert

- When the vehicle cuts in

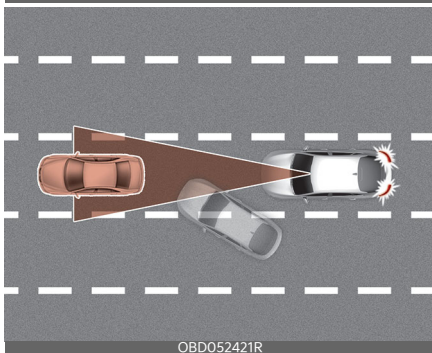
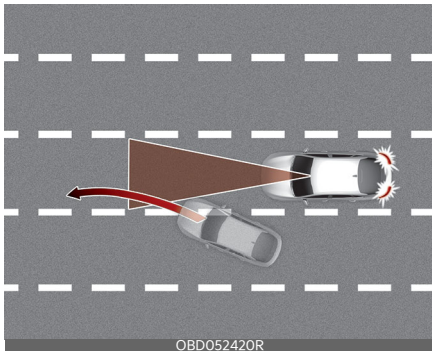

If a vehicle cuts in front of your vehicle, Leading Vehicle Departure Alert may not operate properly.

- When the vehicle ahead sharply steers

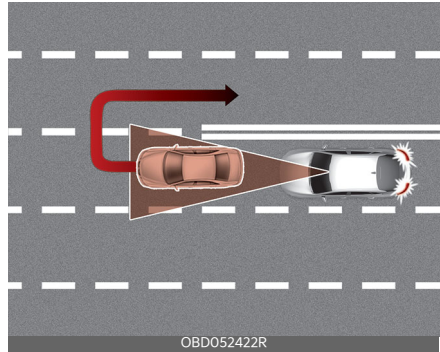

If the vehicle in front makes a sharp turn, such as to turn left or right or make a U-turn, etc., Leading Vehicle Departure Alert may not operate properly.

- When the vehicle ahead abruptly departs

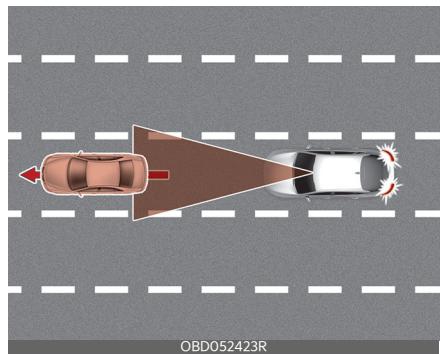

If the vehicle in front abruptly departs, Leading Vehicle Departure Alert may not operate properly.

- When a pedestrian or cyclist is between you and the vehicle ahead



If there is a pedestrian or cyclist in between you and the vehicle in front, Leading Vehicle Departure Alert may not operate properly.

- When in a parking lot

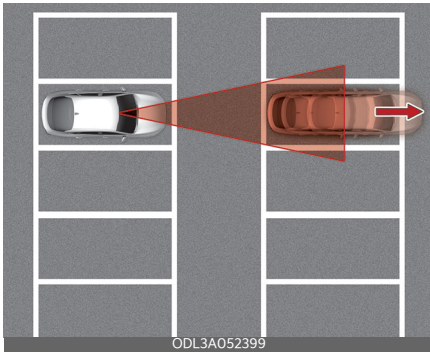

If a vehicle parked in front drives away from you, Leading Vehicle Departure Alert may warn you that the parked vehicle is driving away.

- When driving at a tollgate or intersection, etc.

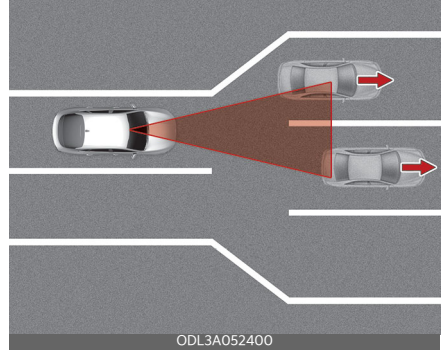

If you pass a tollgate or intersection with lots of vehicles or you drive where lanes are merged or divided frequently, Leading Vehicle Departure Alert may not operate properly.

*** NOTICE**

For more details on the precautions of the front view camera, refer to "Forward Collision-Avoidance Assist (FCA) (Sensor fusion) (if equipped)" on page 6-69.

Cruise Control (CC) (if equipped)



OBD051384L

- (1) Cruise indicator
- (2) Set speed

Cruise Control will allow you to drive at speeds above 30 km/h (20 mph) without depressing the accelerator pedal.

Cruise Control operation

Setting set speed

1. Accelerate to the desired speed, which must be more than 30 km/h (20 mph).



OBD051369

2. Press the Driving Assist button at the desired speed. The set speed and Cruise (🚗 CRUISE) indicator will illuminate on the cluster.
3. Release the accelerator pedal.

Vehicle speed will maintain the set speed even when the accelerator pedal is not depressed.

* NOTICE

On a steep slope, the vehicle may slightly slow down or speed up whilst driving uphill or downhill.

Increasing set speed

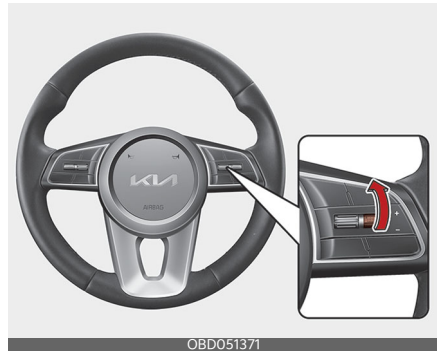

OBD051371

- Push the + switch up and release it immediately. The cruising speed will increase by 1 km/h (1 mph) each time the switch is operated in this manner.
- Push the + switch up and hold it whilst monitoring the set speed on the cluster. The cruising speed will increase to the nearest multiple of ten at first, and then increase by 10 km/h (5 mph) each time the switch is operated in this manner.

Release the switch when the desired speed is shown and the vehicle will accelerate to that speed.

Decreasing set speed



- Push the - switch down and release it immediately. The cruising speed will decrease by 1 km/h (1 mph) each time the switch is operated in this manner.
- Push the - switch down and hold it whilst monitoring the set speed on the cluster. The cruising speed will decrease to the nearest multiple of ten at first, and then decrease by 10 km/h (5 mph) each time the switch is operated in this manner. Release the switch at the speed you want to maintain.

Temporarily pausing Cruise Control

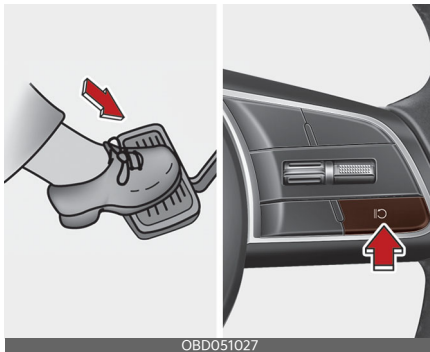

Cruise Control will be paused when:

- Depressing the brake pedal.

- Pressing the || ⏻ button.
- Shifting the gear to N (Neutral).
- Decreasing vehicle speed to less than approximately 30 km/h (20 mph).
- ESC (Electronic Stability Control) is operating.
- The vehicle speed is above 190 km/h (120 mph)

The set speed will turn off but the Cruise (⏻ CRUISE) indicator will stay on.

Resuming the function



Push the +, - switch or || ⏻ button.

If you push the + switch up or - switch down, vehicle speed will be set to the current speed on the cluster.

If you press the || ⏻ button, vehicle speed will resume to the preset speed.

Vehicle speed must be above 30 km/h (20 mph) for the function to resume.

Turning off Cruise Control

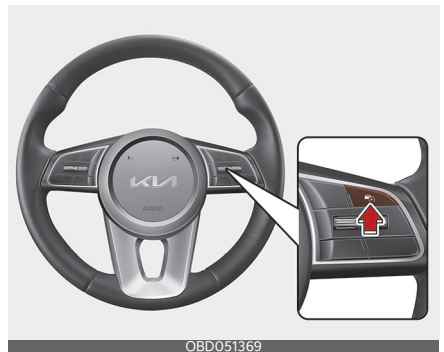

Press the Driving Assist button to turn Cruise Control off. The Cruise indicator will go off.

Always press the Driving Assist button to turn Cruise Control off when not in use.

* NOTICE

Take the following precautions when using Cruise Control:

- Always set the vehicle speed under the speed limit in your country.
- Keep Cruise Control off when the function is not in use, to avoid inadvertently setting a speed. Check that the Cruise (🚗 CRUISE) indicator is off.
- Cruise Control does not substitute for proper and safe driving. It is the responsibility of the driver to always drive safely and should always be aware of unexpected and sudden situations from occurring.
- Always drive cautiously to prevent unexpected and sudden situations from occurring. Pay attention to the road conditions at all times.
- Do not use Cruise Control when it may be unsafe to keep the vehicle at a constant speed:
 - When driving in heavy traffic, or when traffic conditions make it difficult to drive at a constant speed
 - When driving on rainy, icy, or snow-covered roads
 - When driving on hilly or windy roads
 - When driving in windy areas
 - When driving with limited view (possibly due to bad weather, such as fog, snow, rain and sandstorm)

- Do not use Cruise Control when towing a trailer.

⚠ CAUTION

During cruise-speed driving with the manual transmission vehicle, do not shift into neutral without depressing the clutch pedal, since the engine will be over-revved. If this happens, depress the clutch pedal or press the Driving Assist button to turn Cruise Control off.

Smart Cruise Control (SCC) (if equipped)

Smart Cruise Control allows you to program the vehicle to maintain constant speed and distance detecting the vehicle ahead without depressing the accelerator or brake pedal.

Overtaking Acceleration Assist

whilst Smart Cruise Control is operating, if the function judges that the driver is determined to overtake the vehicle in front, acceleration will be assisted.

Detecting sensor



[1]: Front view camera, [2]: Front radar
The front view camera and front radar are used as a detecting sensor to detect front vehicles. Refer to the picture above

for the detailed location of the detecting sensor.

⚠ CAUTION

Always keep the front view camera and front radar in good condition to maintain optimal performance of Smart Cruise Control.

For more details on the precautions of the front view camera and front radar, refer to "Forward Collision-Avoidance Assist (FCA) (Sensor fusion) (if equipped)" on page 6-69.

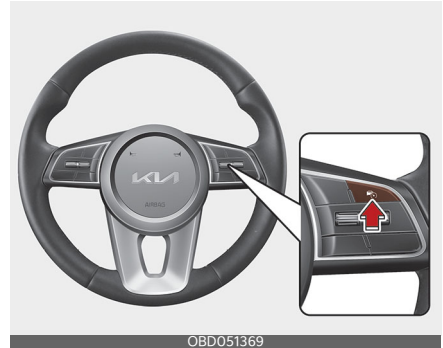

Smart Cruise Control settings

Turning on Smart Cruise Control



- Press the Driving Assist button to turn on the function. The speed will be set to the current speed on the cluster.
- If there is no vehicle in front of you, the set speed will be maintained, but if there is a vehicle in front of you, the speed may decrease to maintain the distance to the vehicle ahead. If the vehicle ahead accelerates, your vehicle will travel at a steady cruising speed after accelerating to the set speed.

*** NOTICE**

- If your vehicle speed is between 0~30 km/h (0~20 mph) when you press the Driving Assist button, the Smart Cruise Control speed will be set to 30 km/h (20 mph).
- The symbol of the Driving Assist button can be applied indifferent such as  MODE or  depending on the vehicle.

Setting Vehicle Distance

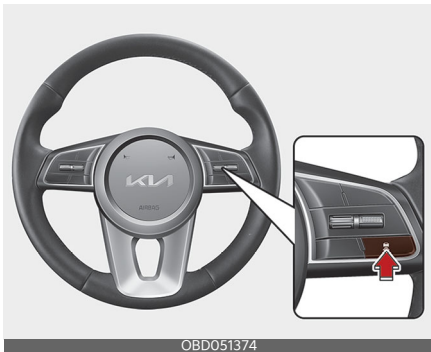

Each time the Vehicle Distance button is pressed, the Vehicle Distance changes as follows:

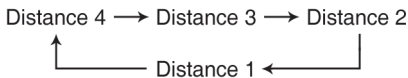

*** NOTICE**

- If you drive at 90 km/h (56 mph), the distance is maintained as follows:
 - Distance 4 - approximately 52.5 m (172 ft.)
 - Distance 3 - approximately 40 m (130 ft.)
 - Distance 2 - approximately 32.5 m (106 ft.)

- Distance 1 - approximately 25 m (82 ft.)
- The distance is set to the last set distance when the engine is restarted, or when the function was temporarily cancelled.

Increasing set speed

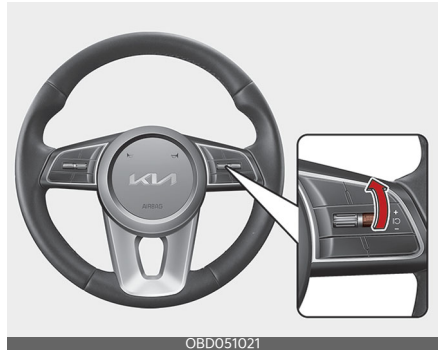

- Push up the + switch, and release it immediately. The cruising speed will increase by 1 km/h (1 mph) each time the switch is operated in this manner.
- Push up the + switch, and hold it whilst monitoring the set speed on the cluster. The cruising speed will increase by 10 km/h or 5 mph each time the switch is operated in this manner. Release the switch when the desired speed is shown, and the vehicle will accelerate to that speed. You can increase the set speed to 180 km/h (110 mph).

⚠ WARNING

Check the driving condition before using the + switch. Driving speed may sharply increase when you push up and hold the + switch.

Decreasing set speed



- Push down the - switch, and release it immediately. The cruising speed will decrease by 1 km/h (1 mph) each time the switch is operated in this manner.
- Push down the - switch, and hold it whilst monitoring the set speed on the cluster. The cruising speed will decrease by 10 km/h or 5 mph each time the switch is operated in this manner.
- Release the switch at the speed you want to maintain. You can decrease the set speed to 30 km/h (20 mph).

To temporarily cancel Smart Cruise Control

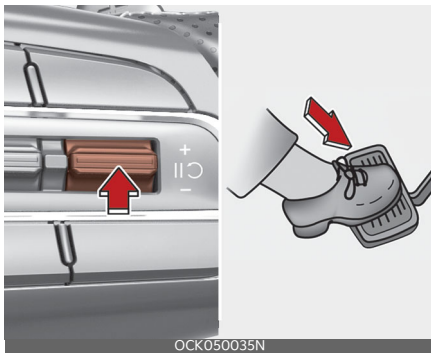

Press the || ⌂ switch or depress the brake pedal to temporarily cancel Smart Cruise Control.

To resume Smart Cruise Control



To resume Smart Cruise Control after the function was cancelled, operate the +, - or || ⌂ switch.

If you push the + switch up or - switch down, vehicle speed will be set to the current speed on the cluster.

If you press the || ⌂ switch, vehicle speed will resume to the preset speed.

⚠ WARNING

Check the driving condition before press the || ⌂ switch. Driving speed may sharply increase or decrease when you press the || ⌂ switch.

To turn off Smart Cruise Control

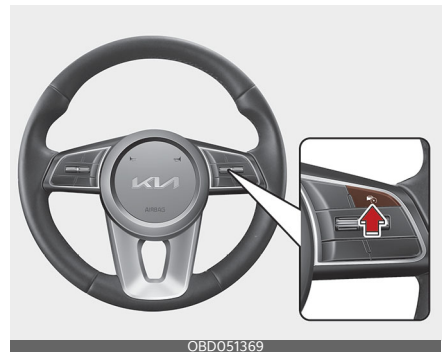

Press the Driving Assist button to turn Smart Cruise Control off.

*** NOTICE**

If your vehicle is equipped with Manual Speed Limit Assist, press and hold the Driving Assist button to turn off Smart Cruise Control. However Manual Speed Limit Assist will turn on.

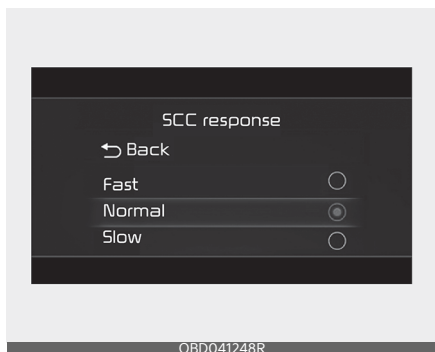
SCC response

The sensitivity of vehicle speed when following the front vehicle to maintain the set distance can be adjusted. With the ignition switch or ENGINE START/STOP button in the ON position, select 'Driver assistance → SCC response' from the 'User settings (LCD display) or Setup → Vehicle (Infotainment System screen)' menu to set one of the three stages you prefer.

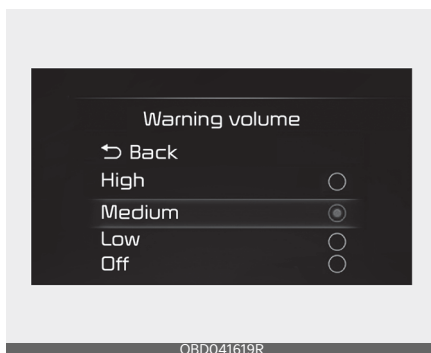
Warning volume

With the ignition switch or ENGINE START/STOP button in the ON position, select 'Driver assistance → Warning volume' from the 'User settings (LCD display) or Setup → Vehicle (Infotainment System screen)' menu to change the Warning Volume to 'High', 'Medium' or 'Low' for Smart CruiseControl. However, even if 'Off' is selected, the Warning volume of Smart Cruise Control will not turn off but the volume will sound as 'Low'. If you change the Warning volume, the Warning volume of other Driver Assistance functions may change.

*** NOTICE**

If the engine is restarted, Warning volume will maintain the last setting.

Smart Cruise Control operating**Operating conditions**

Smart Cruise Control will operate when the following conditions are satisfied.

Basic function

- The gear is in D (Drive)
- The driver's door is closed
- EPB (Electronic Parking Brake) is not applied

- Your vehicle speed is within the operating speed range
10~180 km/h (5~110 mph): when there is no vehicle in front
0~180 km/h (0~110 mph): when there is a vehicle in front
- ESC (Electronic Stability Control), TCS (Traction Control System) or ABS is on
- ESC (Electronic Stability Control), TCS (Traction Control System) or ABS is not controlling the vehicle
- Engine rpm is not in the red zone
- Forward Collision-Avoidance Assist brake control is not operating

* NOTICE

When stopped behind another vehicle, the driver can turn on Smart Cruise Control whilst the brake pedal is depressed.

Overtaking Acceleration Assist

Overtaking Acceleration Assist will operate when the turn signal indicator is turned on to the left (left-hand drive) or turned on to the right (right-hand drive) whilst Smart Cruise Control is operating, and the following conditions are satisfied:

- Your vehicle speed is above 60 km/h (40 mph)
- The hazard warning flasher is off
- A vehicle is detected in front of your vehicle
- Deceleration is not needed to maintain distance with the vehicle in front

⚠ WARNING

- When the turn signal indicator is turned on to the left (left-hand drive) or turned on to the right (right-hand drive) whilst there is a vehicle ahead,

the vehicle may accelerate temporarily. Pay attention to the road conditions at all times.

- Regardless of your country's driving direction, Overtaking Acceleration Assist will operate when the conditions are satisfied. When using the function in countries with different driving direction, always check the road conditions at all times.

Displaying operating status

Operating

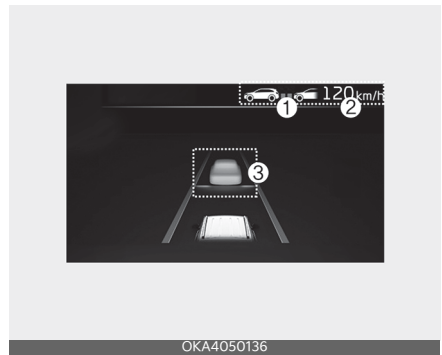

Temporarily cancelled



You can see the status of the Smart Cruise Control operation in the Driving

Assist view on the cluster. Refer to "Instrument cluster" on page 4-52. Smart Cruise Control will be displayed as below depending on the status of the function.

- When operating
 - (1) Whether there is a vehicle ahead and the selected distance level are displayed.
 - (2) Set speed is displayed.
 - (3) Whether there is a vehicle ahead and the target vehicle distance are displayed.
- When temporarily cancelled
 - (1)  CRUISE indicator is displayed.
 - (2) The previous set speed is shaded.

*** NOTICE**

- The actual distance with the front vehicle is displayed.
- The target distance may vary according to the vehicle speed and the set distance level. If vehicle speed is low, even though the vehicle distance have changed, the change of the target vehicle distance may be small.

To temporarily accelerate



If you want to speed up temporarily when Smart Cruise Control is on, depress the accelerator pedal for a cer-

tain amount. whilst depressing the accelerator pedal for a certain amount, the set speed, distance level and target distance will blink on the cluster. However, if the accelerator pedal is insufficiently depressed, the vehicle may slow down.

⚠ WARNING

Be careful when accelerating temporarily, because the speed is not controlled automatically even if there is a vehicle in front of you.

Smart Cruise Control temporarily cancelled



Smart Cruise Control will be temporarily cancelled automatically when:

- The vehicle speed is above 180 km/h (110 mph)
- The vehicle is stopped for a certain period of time
- The accelerator pedal is continuously depressed for a certain period of time
- The conditions for Smart Cruise Control to operate is not satisfied

If the function is temporarily cancelled, the 'SCC (Smart Cruise Control) cancelled' warning message will appear on the cluster, and an audible warning will sound to warn the driver.

If Smart Cruise Control is temporarily cancelled whilst the vehicle is at a standstill with the function operating, EPB (Electronic Parking Brake) maybe applied.

⚠ WARNING

When the function is temporarily cancelled, distance with the front vehicle will not be maintained. Always have your eyes on the road whilst driving, and if necessary, depress the brake pedal to reduce your driving speed in order to maintain a safe distance.

Smart Cruise Control conditions not satisfied

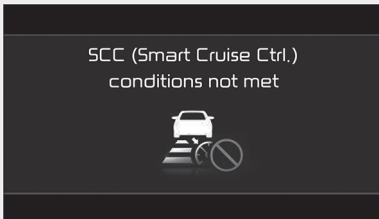

OBDO41243R

If the Driving Assist button, +, - or || ↻ switch is pushed when the function's operating conditions are not satisfied, the 'SCC (Smart Cruise Control) conditions not met' will appear on the cluster, and an audible warning will sound.

In traffic situation



OMQ4050288R

In traffic, your vehicle will stop if the vehicle ahead of you stops. Also, if the vehicle ahead of you starts moving, your vehicle will start as well. In addition, after the vehicle has stopped and a certain time have passed, the 'Leading vehicle is driving on' message will appear on the cluster. Depress the accelerator pedal or push the + switch, - switch or || ↻ switch to start driving.

⚠ WARNING

whilst the message is displayed on the cluster, if there is no vehicle in front or the vehicle is far away from you, and the + switch, - switch or || ↻ switch is pushed, Smart Cruise Control will automatically cancel and the EPB will be applied. However, if the accelerator pedal is depressed, EPB will not be applied even though the function is cancelled. Always pay attention to the road condition ahead.

Warning road conditions ahead

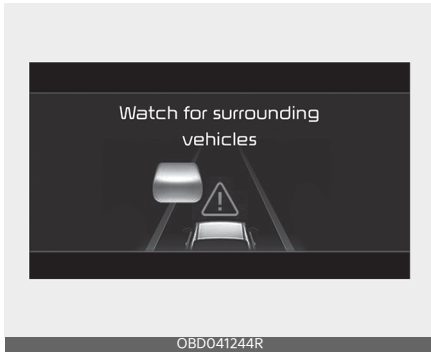

In the following situation, the 'Watch for surrounding vehicles' warning message will appear on the cluster, and an audible warning will sound to warn the driver of road conditions ahead.

The vehicle in front disappears when Smart Cruise Control is maintaining the distance with the vehicle ahead whilst driving in low speed.

⚠ WARNING

Always pay attention to vehicles or objects that may suddenly appear in front of you, and if necessary, depress the brake pedal to reduce your driving speed in order to maintain a safe distance.

Collision warning!



whilst Smart Cruise Control is operating, when the collision risk with the vehicle ahead is high, the 'Collision warning!' warning message will appear on the cluster, and an audible warning will sound to warn the driver. Always have your eyes on the road whilst driving, and if necessary, depress the brake pedal to reduce your driving speed in order to maintain a safe distance.

⚠ WARNING

- In the following situations, Smart Cruise Control may not warn the driver of a collision.
 - The distance from the front vehicle is near, or the vehicle speed of the other vehicle is faster or similar with your vehicle
 - The speed of the front vehicle is very slow or is at a standstill
 - The accelerator pedal is depressed right after Smart Cruise Control is turned on

⚠ WARNING

Take the following precautions when using Smart Cruise Control :

- Smart Cruise Control does not substitute for proper and safe driving. It is the responsibility of the driver to always check the speed and distance to the vehicle ahead.
- Smart Cruise Control may not recognize unexpected and sudden situations or complex driving situations, so always pay attention to driving conditions and control your vehicle speed.
- Keep Smart Cruise Control off when the function is not in use to avoid inadvertently setting a speed.
- Do not open the door or leave the vehicle when Smart Cruise Control is operating, even if the vehicle is stopped.
- Always be aware of the selected speed and vehicle distance.
- Keep a safe distance according to road conditions and vehicle speed. If the vehicle distance is too close during high-speed driving, a serious collision may result.
- When maintaining distance with the vehicle ahead, if the front vehicle disappears, the function may suddenly accelerate to the set speed. Always be aware of unexpected and sudden situations from occurring.
- Vehicle speed may decrease on an upward slope and increase on a downward slope.
- Always be aware of situations such as when a vehicle cuts in suddenly.
- When you are towing a trailer or another vehicle, we recommend that Smart Cruise Control is turned off due to safety reasons.
- Turn off Smart Cruise Control when your vehicle is being towed.
- Smart Cruise Control may not operate normally if interfered by strong electromagnetic waves.
- Smart Cruise Control may not detect an obstacle in front and lead to a collision. Always look ahead cautiously to prevent unexpected and sudden situations from occurring.
- Vehicles moving in front of you with a frequent lane change may cause a delay in the function's reaction or may cause the function to react to a vehicle actually in an adjacent lane. Always drive cautiously to prevent unexpected and sudden situations from occurring.
- Always be aware of the surroundings and drive safely, even though a warning message does not appear or an audible warning does not sound.
- If any other function's warning message is displayed or warning sound is generated, Smart Cruise Control warning message may not be displayed and warning sound may not be generated.
- You may not hear the warning sound of Forward Collision-Avoidance Assist if the surrounding is noisy.
- The vehicle manufacturer is not responsible for any traffic violation or accidents caused by the driver.
- Always set the vehicle speed under the speed limit in your state.

*** NOTICE**

- Smart Cruise Control may not operate in few seconds after the vehicle is started or the front view camera or front radar is initialized.

- You may hear a sound when the brake is controlled by Smart Cruise Control.

Smart Cruise Control malfunction and limitations

Smart Cruise Control malfunction

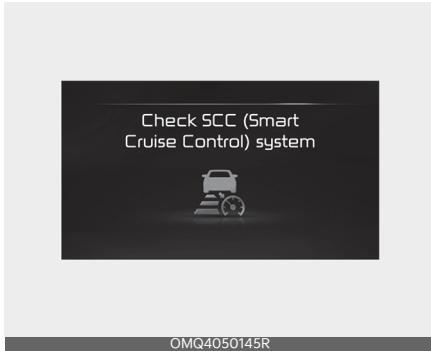

When Smart Cruise Control is not working properly, the 'Check SCC (Smart Cruise Control) system' warning message will appear (turns off after a certain time), and the  warning light will illuminate on the cluster. In this case, have the function checked by a professional workshop. Kia recommends to visit an authorised Kia dealer/service partner.

Smart Cruise Control disabled

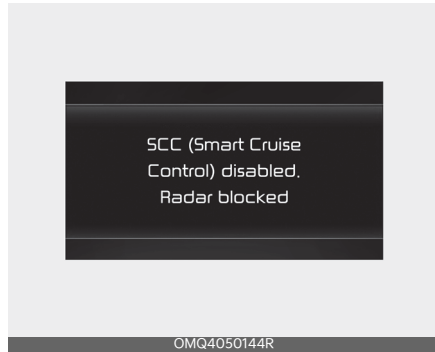

When the front radar cover or sensor is covered with snow, rain, or foreign matters, it can reduce the detecting performance and temporarily limit or disable Smart Cruise Control.

If this occurs, the 'SCC (Smart Cruise Control) disabled. Radar blocked' warning message will appear for a certain period of time on the cluster.

The function will operate normally when such snow, rain or foreign matter is removed.

WARNING

Even though the warning message does not appear on the cluster, Smart Cruise Control may not properly operate.

CAUTION

Smart Cruise Control may not properly operate in an area (e.g. open terrain), where any substance are not detected after turning ON the engine.

Limitations of Smart Cruise Control

Smart Cruise Control may not operate normally, or the function may operate

unexpectedly under the following circumstances:

- The detecting sensor or the surroundings are contaminated or damaged
- Washer fluid is continuously sprayed, or the wiper is on
- The camera lens is contaminated due to tinted, filmed or coated windscreen, damaged glass, or stuck of foreign matters (sticker, bug, etc.) on the glass
- Moisture is not removed or frozen on the windscreen
- The field of view of the front view camera is obstructed by sun glare
- Street light or light from an oncoming vehicle is reflected on the wet road surface, such as a puddle in the road
- The temperature around the front view camera is high or low
- An object is placed on the dashboard
- The surrounding is very bright
- The surrounding is very dark, such as in a tunnel, etc.
- The brightness changes suddenly, for example when entering or exiting a tunnel
- The brightness outside is low, and the headlamps are not on or are not bright
- Driving in heavy rain or snow, or thick fog
- Driving through steam, smoke or shadow
- Only part of the vehicle is detected
- The vehicle in front has no tail lights, tail lights are located unusually, etc.
- The brightness outside is low, and the tail lamps are not on or are not bright
- The rear of the front vehicle is small or does not look normal (i.e. tilted, overturned, etc.)
- The front vehicle's ground clearance is low or high
- Your vehicle is being towed
- A vehicle suddenly cuts in front
- Driving through a tunnel or railroad bridge
- A material is near that reflects very well on the front radar, such as a guardrail, nearby vehicle, etc.
- The bumper around the front radar is impacted, damaged or the front radar is out of position
- The temperature around the front radar is high or low
- Driving in large areas where there are few vehicles or structures (i.e. desert, meadow, suburb, etc.)
- The vehicle in front is made of material that does not reflect on the front radar
- Driving near a highway (or motorway) interchange or tollgate
- Driving on a slippery surface due to snow, water puddle, ice, etc.
- Driving on a curved road
- The vehicle in front is detected late
- The vehicle in front is suddenly blocked by an obstacle
- The vehicle in front suddenly changes lane or suddenly reduces speed
- The vehicle in front is bent out of shape
- The front vehicle's speed is fast or slow
- With a vehicle in front, your vehicle changes lane at low speed
- The vehicle in front is covered with snow

- You are driving unstably
- You are on a roundabout and the vehicle in front is not detected
- You are continuously driving in a circle
- Driving in a parking lot
- Driving through a construction area, unpaved road, partial paved road, uneven road, speed bumps, etc.
- Driving on an incline road, curved road, etc.
- Driving through a roadside with trees or streetlights
- The adverse road conditions cause excessive vehicle vibrations whilst driving
- Your vehicle height is low or high due to heavy loads, abnormal tyre pressure, etc.
- Driving through a narrow road where trees or grass or overgrown
- There is interference by electromagnetic waves, such as driving in an area with strong radio waves or electrical noise

• **Driving on curved road**

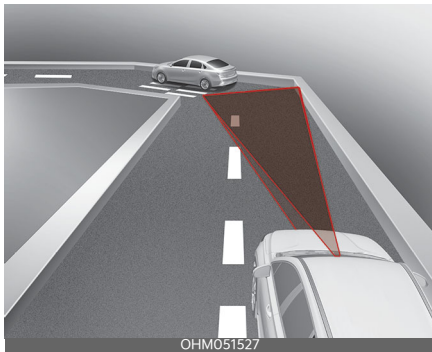

On curves, Smart Cruise Control may not detect a vehicle in the same lane, and may accelerate to the set speed. Also, vehicle speed may rapidly

decrease when the vehicle ahead is detected suddenly.

Select the appropriate set speed on curves and apply the brake pedal or accelerator pedal according to the road and driving conditions ahead.

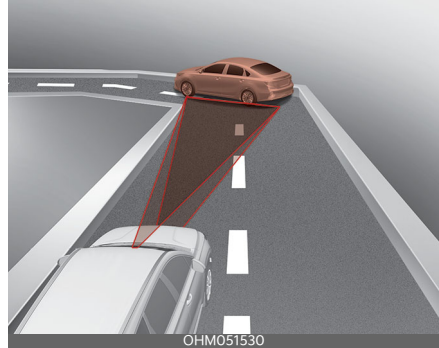

Your vehicle speed can be reduced due to a vehicle in the adjacent lane.

Apply the accelerator pedal and select the appropriate set speed. Check to be sure that the road conditions permit safe operation of Smart Cruise Control.

• **Driving on a slope**



During uphill or downhill driving, Smart Cruise Control may not detect a moving vehicle in your lane, and cause your vehicle to accelerate to the set speed. Also, vehicle speed will rapidly decrease

when the vehicle ahead is detected suddenly.

Select the appropriate set speed on inclines and apply the brake pedal or accelerator pedal according to the road and driving conditions ahead.

• **Changing lanes**

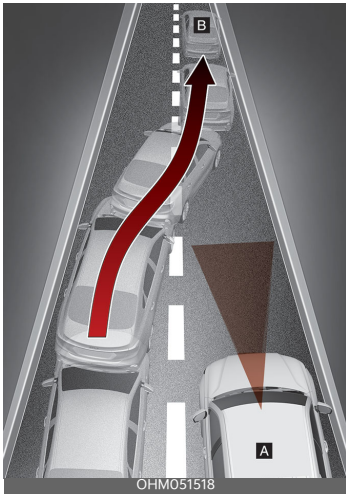

[A]: Your vehicle, [B]: Lane changing vehicle

When a vehicle moves into your lane from an adjacent lane, it cannot be detected by the sensor until it is in the sensor's detection range.

Smart Cruise Control may not immediately detect the vehicle when the vehicle changes lanes abruptly. In this case, you must maintain a safe braking distance, and if necessary, depress the brake pedal to reduce your driving speed in order to maintain a safe distance.

• **Detecting vehicle**

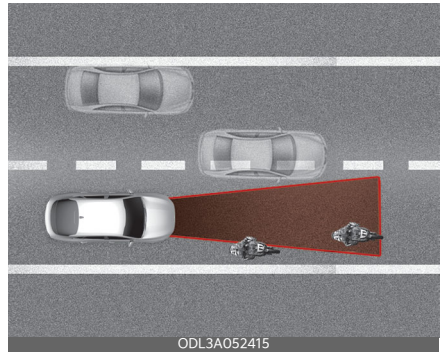

In the following cases, some vehicles in your lane cannot be detected by the sensor:

- Vehicles offset to one side
- Slow-moving vehicles or sudden-decelerating vehicles
- Oncoming vehicles
- Stopped vehicles
- Vehicles with small rear profile, such as trailers
- Narrow vehicles, such as motorcycles or bicycles
- Special vehicles
- Animals and pedestrians

6

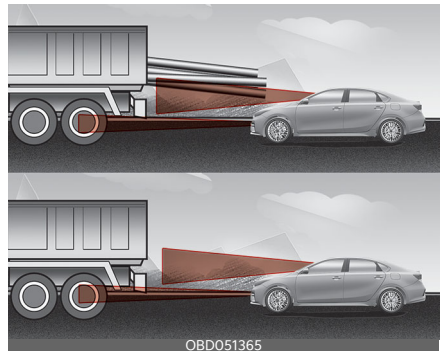

In the following cases, the vehicle in front cannot be detected by the sensor:

- Vehicles with higher clearance or vehicles carrying loads that stick out of the back of the vehicle
- Vehicles that has the front lifted due to heavy loads
- You are steering your vehicle
- Driving on narrow or sharply curved roads

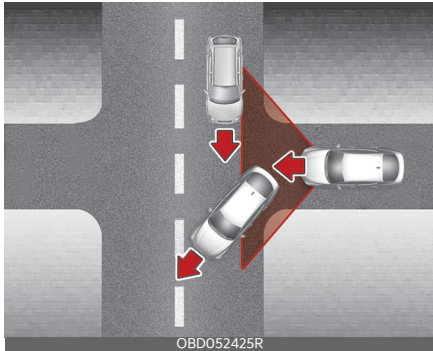

When a vehicle ahead disappears at an intersection, your vehicle may accelerate. Always pay attention to road and driving conditions whilst driving.

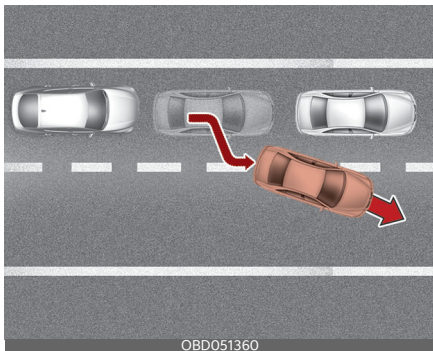

When a vehicle in front of you merges out of the lane, Smart Cruise Control may not immediately detect the new vehicle that is now in front of you. Always pay attention to road and driving conditions whilst driving.

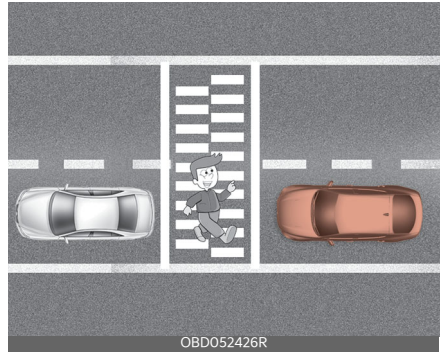

Always look out for pedestrian when your vehicle is maintaining a distance with the vehicle ahead.

Lane Following Assist (LFA) (if equipped)

Lane Following Assist is designed to detect lane markings or vehicles on the road, and assists the driver's steering to help centre the vehicle in the lane.

Detecting sensor



[1]: Front view camera

The front view camera is used as a detecting sensor to detect lane markings and front vehicles. Refer to the picture above for the detailed location of the detecting sensor.

⚠ CAUTION

For more details on the precautions of the front view camera, refer to "Forward Collision-Avoidance Assist (FCA) (Sensor fusion) (if equipped)" on page 6-69.

Lane Following Assist settings

Turning Lane Following Assist ON/OFF



With the ignition switch or ENGINE START/STOP button in the ON position, press the Lane Driving Assist button located on the steering wheel to turn on Lane Following Assist. The white or green (🚗) indicator light will illuminate on the cluster.

Press the Lane Driving Assist button again to turn off the function.

Warning volume

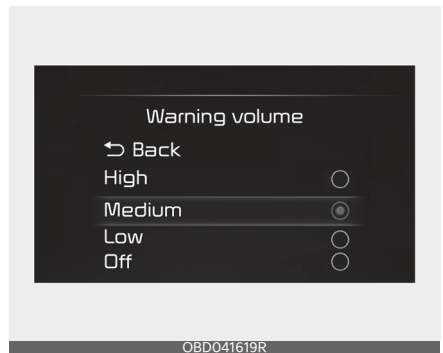

With the ignition switch or ENGINE START/STOP button in the ON position, select 'Driver assistance → Warning vol-

ume' from the 'User settings (LCD display) or Setup → Vehicle (Infotainment System screen)' menu to change the Warning Volume to 'High', 'Medium', 'Low' or 'Off' (if equipped) for Hands-off warning. However, even if 'Off' is selected, the Hands-off Warning volume will not turn off but the volume will sound as 'Low'.

If you change the Warning volume, the Warning volume of other Driver Assistance functions may change.

*** NOTICE**

If your vehicle is equipped with additional Infotainment System, please scan the QR code in a separately supplied Car Infotainment System Quick Reference Guide.

**Lane Following Assist operation
Warning and control**

Lane Following Assist



If the vehicle ahead or both lane markings are detected and your vehicle speed is below 180 km/h (110 mph), the green (🚗) indicator light will illuminate on the cluster, and the function will help

the vehicle stay in lane by controlling the steering wheel.

⚠ CAUTION

When the steering wheel is not controlled, the green (🚗) indicator light will blink and change to white.

Hands-off warning

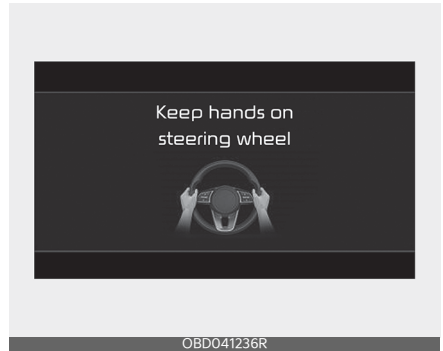

If the driver takes their hands off the steering wheel for several seconds, the 'Keep hands on steering wheel' warning message will appear and an audible warning will sound in stages.

- First stage: Warning message
- Second stage: Warning message (red steering wheel) and audible warning

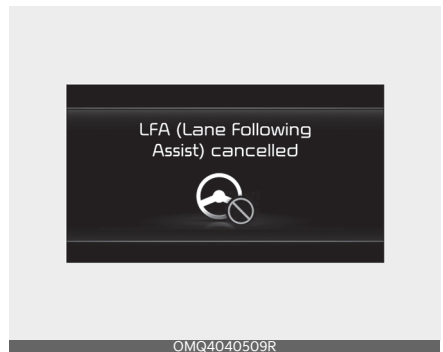

If the driver still does not have their hands on the steering wheel after the hands-off warning, the 'LFA (Lane Following Assist) cancelled' warning message will appear and Lane Following Assist will be automatically cancelled.

⚠ WARNING

- The steering wheel may not be assisted if the steering wheel is held very tight or the steering wheel is steered over a certain degree.
- Lane Following Assist does not operate at all times. It is the responsibility of the driver to safely steer the vehicle and to maintain the vehicle in its lane.
- The hands-off warning message may appear late depending on road conditions. Always have your hands on the steering wheel whilst driving.
- If the steering wheel is held very lightly the hands-off warning message may appear because the function may not recognize that the driver has their hands on the steering wheel.
- If you attach objects to the steering wheel, the hands-off warning may not work properly.

* NOTICE

- For more details on setting the functions in the infotainment function, refer to "LCD display modes (for Type B cluster)" on page 4-62.
- When both lane markings are detected, the lane lines on the cluster will change from gray to white.

Lane undetected



Lane detected



- If lane markings are not detected, steering wheel control by Lane Following Assist can be limited depending on whether a vehicle is in front or the driving conditions of the vehicle.
- Even though the steering is assisted by Lane Following Assist, the driver may control the steering wheel.
- The steering wheel may feel heavier or lighter when the steering wheel is assisted by the function than when it is not.

Lane Following Assist malfunction and limitations

Lane Following Assist malfunction

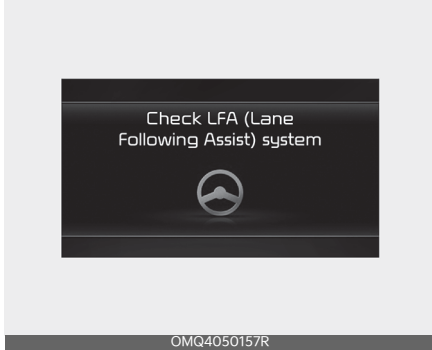

When Lane Following Assist is not working properly, the 'Check LFA (Lane Following Assist) system' warning message will appear on the cluster (turns off after a certain time) and the  warning light will illuminate.

If this occurs, have the function checked by a professional workshop. Kia recommends to visit an authorised Kia dealer/service partner.

Limitations of Lane Following Assist

For more details on system limitations, refer to "Lane Keeping Assist (LKA) (if equipped)" on page 6-81.

CAUTION

For more details on the function precautions, refer to "Lane Keeping Assist (LKA) (if equipped)" on page 6-81.

Rear Cross-Traffic Collision Warning (RCCW) (if equipped)

Rear Cross-Traffic Collision Warning is designed to detect vehicles approaching from the left and right side whilst your vehicle is reversing, and warning the driver that a collision is imminent with a warning message and an audible warning.

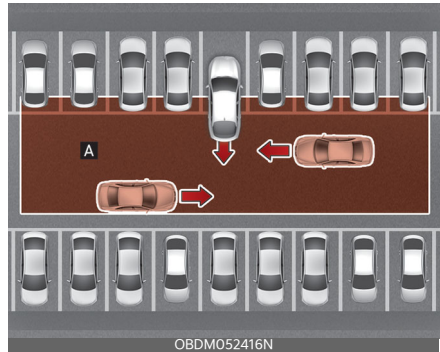

[A]: Rear Cross-Traffic Collision Warning operating range

CAUTION

The time of warning may vary depending on vehicle speed of the approaching vehicle.

Detecting sensor

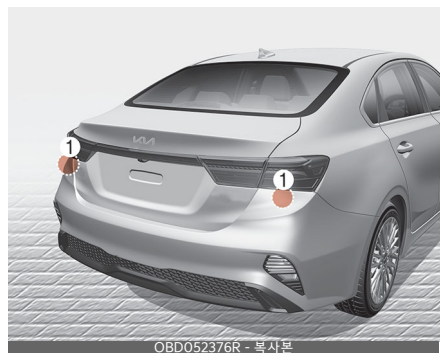

[1]: Rear corner radar

Refer to the picture above for the detailed location of the detecting sensor.

CAUTION

For more details on the precautions of the rear corner radar, refer to "Blind-Spot Collision Warning (BCW) (if equipped)" on page 6-86.

Rear Cross-Traffic Collision Warning settings

Rear cross-traffic safety

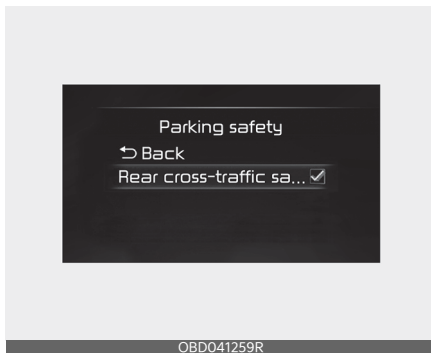

With the ignition switch or ENGINE START/STOP button in the ON position, select 'Driver assistance → Parking safety → Rear cross-traffic safety' from the 'User settings (LCD display)' menu to turn on Rear Cross-Traffic Collision Warning and deselect to turn off the function.

WARNING

When the engine is restarted, Rear Cross-Traffic Collision Warning will always turn on. However, if 'Off' is selected after the engine is restarted, the driver should always be aware of the surroundings and drive safely.

*** NOTICE**

If the engine is restarted, Warning timing and Warning volume will maintain the last setting.

Warning timing



With the ignition switch or ENGINE START/STOP button in the ON position, select 'Driver assistance → Warning timing' from the 'User settings (LCD display) or Setup → Vehicle (Infotainment System screen)' menu to change the initial warning activation time for Rear Cross-Traffic Safety system.

When the vehicle is first delivered, warning timing is set to Normal. If you change the Warning Timing, the warning time of other Driver Assist functions may change.

Always be aware before changing the warning timing.

Warning volume

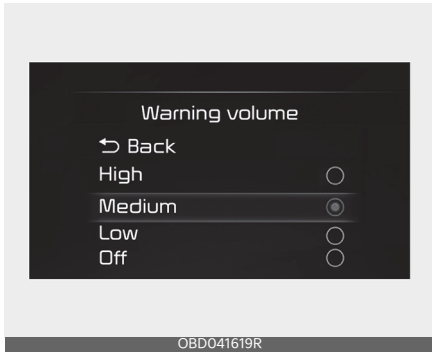

With the ignition switch or ENGINE START/STOP button in the ON position, select 'Driver assistance → Warning volume' from the 'User settings (LCD display) or Setup → Vehicle (Infotainment System screen)' menu to change the Warning Volume to 'High', 'Medium', 'Low' or 'Off' (if equipped) for Rear Cross-Traffic Collision Warning.

However, when Warning volume is turned off, the steering wheel vibration function will turn on if it was turned off. If you change the Warning volume, the Warning volume of other Driver Assistance functions may change.

⚠ CAUTION

- The setting of the Warning Timing and Warning Volume applies to all functions of Rear Cross-Traffic Collision Warning.
- Even though 'Normal' is selected for Warning Timing, if the vehicles from the left and right side approaches at high speed, the initial warning activation time may seem late.
- Select 'Late' for Warning Timing when traffic is light and when driving speed is slow.

* NOTICE

If the ENGINE START/STOP button is changed to the ON position, Warning Timing and Warning Volume will maintain the last setting.

* NOTICE

If your vehicle is equipped with additional Infotainment System, please scan the QR code in a separately supplied Car Infotainment System Quick Reference Guide.

Rear Cross-Traffic Collision Warning

Rear Cross-Traffic Collision Warning will warn the driver when a collision is imminent.

Collision warning





To warning the driver of an approaching vehicle from the rear left/right side of your vehicle, the outside rearview mirror will blink and a warning will appear on the cluster. At the same time, an audible warning will sound. If Rear View Monitor is operating, a warning will also appear on the infotainment screen.

Rear Cross-Traffic Collision Warning will operate when the following conditions are satisfied:

- Your vehicle gear is shifted to R (Reverse)
- Your vehicle speed is below 8 km/h (5 mph)
- The approaching vehicle is within approximately 25 m (82 feet) from the left and right side of your vehicle
- The speed of the vehicle approaching from the left and right is above 5 km/h (3 mph)

*** NOTICE**

If the operating conditions are satisfied, there will be a warning whenever the vehicle approaches from the left or right side even though your vehicle speed is 0 km/h (0 mph).

Rear Cross-Traffic Collision Warning malfunction and limitations

Rear Cross-Traffic Collision Warning malfunction

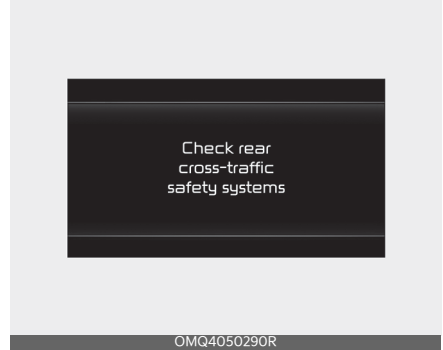

When Rear Cross-Traffic Collision Warning is not working properly, the 'Check rear cross-traffic safety systems' warning message will appear on the cluster, and the function will turn off automatically, or the function will be limited. We recommend that you have your vehicle inspected by an authorized Kia dealer/ service partner.

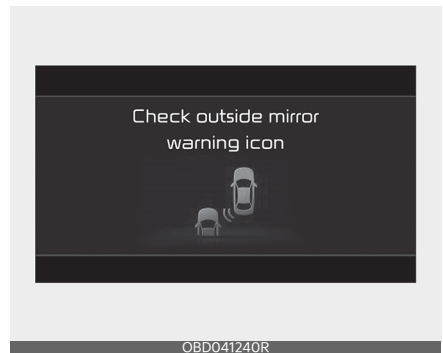

When the warning light on the side view mirror (outside mirror) is not working properly, the 'Check outside mirror warning icon' warning message will

appear on the cluster. We recommend that you have your vehicle inspected by an authorized Kia dealer/service partner.

Rear Cross-Traffic Collision Warning disabled

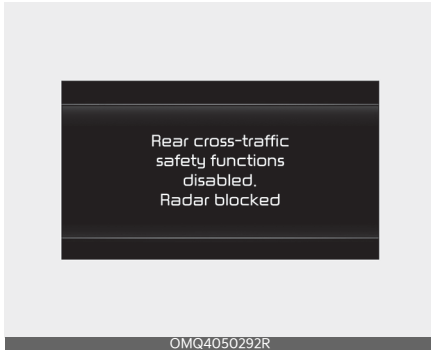

When the rear bumper around the rear-side radar or sensor is covered with foreign matters, such as snow or rain, or installing a trailer or carrier, it can reduce the detecting performance and temporarily limit or disable Rear Cross-Traffic Collision Warning.

If this occurs, the 'Rear cross-traffic safety functions disabled. Radar blocked' warning message will appear on the cluster.

The function will operate normally when such foreign matters or trailer, etc. is removed.

If the function does not operate normally after it is removed, We recommend that you have your vehicle inspected by an authorized Kia dealer/service partner.

⚠ WARNING

- Even though the warning message does not appear on the cluster, Rear Cross-Traffic Collision Warning may not properly operate.
- Rear Cross-Traffic Collision Warning may not properly operate in an area (e.g. open terrain), where any substance are not detected after turning ON the engine.

⚠ CAUTION

Turn off Rear Cross-Traffic Collision Warning to install a trailer, carrier, etc., or remove the trailer, carrier, etc. to use Rear Cross-Traffic Collision Warning.

Limitations of Rear Cross-Traffic Collision Warning

Rear Cross-Traffic Collision Warning may not operate normally, or the function may operate unexpectedly under the following circumstances:

- Departing from where trees or grass is overgrown
- Departing from where roads are wet
- Speed of the approaching vehicle is fast or slow

⚠ CAUTION

For more details on the limitations of the rear corner radar, refer to "Blind-Spot Collision Warning (BCW) (if equipped)" on page 6-86.

⚠ WARNING

- **Driving near a vehicle or structure**

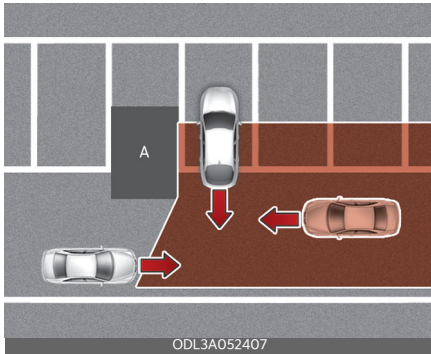

[A]: Structure

Rear Cross-Traffic Collision Warning may be limited when driving near a vehicle or structure, and may not detect the vehicle approaching from the left or right. If this occurs, the function may not warn the driver when necessary.

Always check your surroundings whilst backing up.

- **When the vehicle is in a complex parking environment**

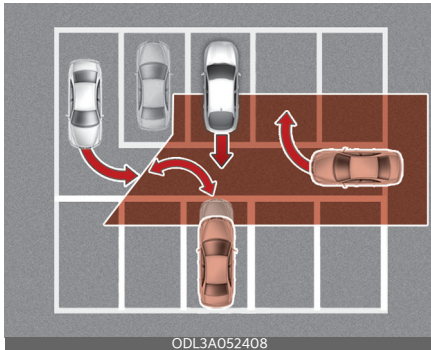

Rear Cross-Traffic Collision Warning may detect vehicles which are parking or pulling out near your vehicle (e.g. a vehicle leaving beside your vehicle, a vehicle parking or pulling out in the rear

area, a vehicle approaching your vehicle making a turn, etc.). If this occurs, the function may unnecessarily warn the driver.

Always check your surroundings whilst backing up.

- **When the vehicle is parked diagonally**

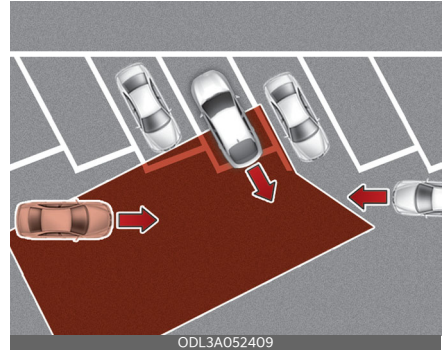

[A]: Vehicle

Rear Cross-Traffic Collision Warning may be limited when backing up diagonally, and may not detect the vehicle approaching from the left or right. If this occurs, the function may not warn the driver when necessary.

Always check your surroundings whilst backing up.

- **When the vehicle is on or near a slope**

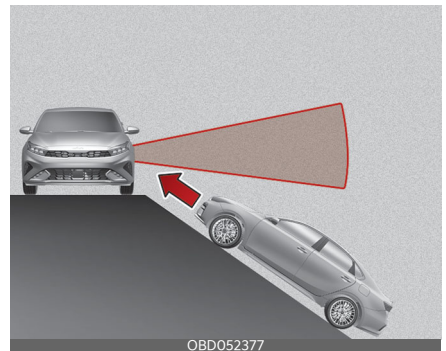

Rear Cross-Traffic Collision Warning may be limited when the vehicle is on an uphill or downhill slope, or near it, and may not detect the vehicle approaching from the left or right. If this occurs, the function may not warn the driver when necessary.

Always check your surroundings whilst backing up.

- **Pulling into the parking space where there is a structure**

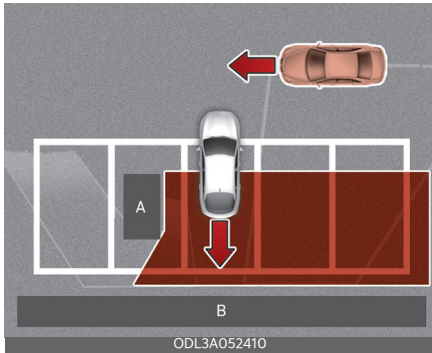

[A]: Structure, [B]: Wall

Rear Cross-Traffic Collision Warning may detect vehicles passing by in front of you when parking backwards into a parking space with a wall or structure in the rear or side area. If this occurs, the function may unnecessarily warn the driver.

Always check your surroundings whilst backing up.

- **When the vehicle is parked rearward**

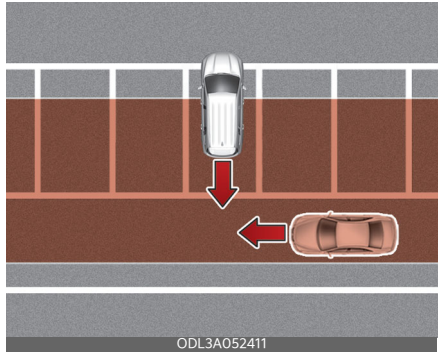

Rear Cross-Traffic Collision Warning may detect vehicles passing by behind you when parking backwards into a parking space. If this occurs, the function may unnecessarily warn the driver. Always check your surroundings whilst backing up.

⚠ WARNING

- Rear Cross-Traffic Collision Warning may not operate normally if interfered by strong electromagnetic waves.
- Rear Cross-Traffic Collision Warning may not operate for 3 seconds after the vehicle is started, or the rear corner radars are initialized.

Rear Cross-Traffic Collision-Avoidance Assist (RCCA) (if equipped)

Rear Cross-Traffic Collision-Avoidance Assist is designed to detect vehicles approaching from the left and right side whilst your vehicle is reversing, and warning the driver that a collision is imminent with a warning message and an audible warning. Also, to help prevent collision braking assist is applied.

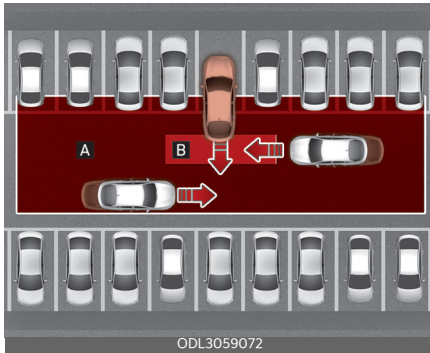

[A]: Rear Cross-Traffic Collision Warning operating range

[B]: Rear Cross-Traffic Collision-Avoidance Assist operating range

⚠ CAUTION

The time of warning may vary depending on vehicle speed of the approaching vehicle.

* NOTICE

In the following text, Rear Cross-Traffic Collision Warning and Rear Cross-Traffic Collision-Avoidance Assist will be referred as Rear Cross-Traffic Safety system.

Detecting sensor



[1]: Rear corner radar

Refer to the picture above for the detailed location of the detecting sensor.

⚠ CAUTION

For more details on the precautions of the rear corner radar, refer to "Blind-Spot Collision-Avoidance Assist (BCA) (if equipped)" on page 6-94.

Rear Cross-Traffic Collision-Avoidance Assist settings

Rear Cross-Traffic Safety

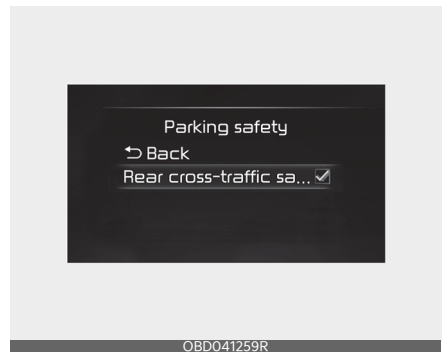

With the ignition switch or ENGINE START/STOP button in the ON position, select 'Driver assistance → Parking safety → Rear cross-traffic safety' from

the 'User settings (LCD display) or Setup → Vehicle (Infotainment System screen)' menu to turn on Rear Cross-Traffic Safety system and deselect to turn off the function.

⚠ WARNING

When the engine is restarted, Rear Cross-Traffic Safety system will always turn on. However, if 'Off' is selected after the engine is restarted, the driver should always be aware of the surroundings and drive safely.

*** NOTICE**

Settings for Rear Cross-Traffic Safety system include Rear Cross-Traffic Collision Warning and Rear Cross-Traffic Collision-Avoidance Assist.

*** NOTICE**

If the engine is restarted, Warning timing and Warning volume will maintain the last setting.

Warning timing

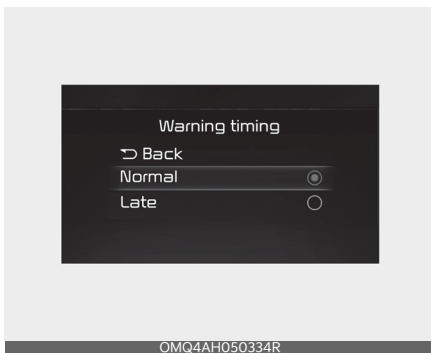

With the ignition switch or ENGINE START/STOP button in the ON position, select 'Driver assistance → Warning timing' from the 'User settings (LCD display)

or Setup → Vehicle (Infotainment System screen)' menu to change the initial warning activation time for Rear Cross-Traffic Safety system.

When the vehicle is first delivered, warning timing is set to Normal. If you change the Warning Timing, the warning time of other Driver Assist functions may change.

Always be aware before changing the warning timing.

Warning volume

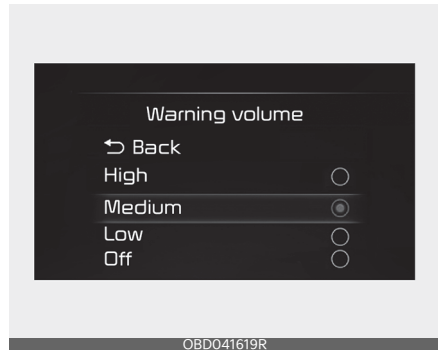

With the ignition switch or ENGINE START/STOP button in the ON position, select 'Driver assistance → Warning volume' from the 'User settings (LCD display) or Setup → Vehicle (Infotainment System screen)' menu to change the Warning Volume to 'High', 'Medium', 'Low' or 'Off' for Rear Cross-Traffic Collision-Avoidance Assist. However, when Warning volume is turned off, the steering wheel vibration function will turn on if it was turned off.

If you change the Warning volume, the Warning volume of other Driver Assistance functions may change.

⚠ CAUTION

- The setting of the Warning timing and Warning volume applies to all functions of the Rear Cross-Traffic Safety system.
- Even though 'Normal' is selected for Warning Timing, if the vehicles from the left and right side approaches at high speed, the initial warning activation time may seem late.
- Select 'Late' for Warning Timing when traffic is light and when driving speed is slow.

*** NOTICE**

If your vehicle is equipped with additional Infotainment System, please scan the QR code in a separately supplied Car Infotainment System Quick Reference Guide.

Rear Cross-Traffic Collision-Avoidance Assist operation

Warning and control

Rear Cross-Traffic Safety system will warning and control the vehicle depending on collision level: 'Collision warning', 'Emergency braking' and 'Stopping vehicle and ending brake control'.

Collision warning



- To warn the driver of an approaching vehicle from the rear left/right side of your vehicle, the warning light on the side view mirror (outside mirror) will blink and a warning message will

appear on the cluster. At the same time, an audible warning will sound.

- The function will operate when the following conditions are satisfied:
 - Your vehicle gear is shifted to R (Reverse)
 - Your vehicle speed is below 8 km/h (5 mph)
 - The approaching vehicle is within approximately 25 m (82 ft.) from the left and right side of your vehicle
 - The speed of the vehicle approaching from the left and right is above 5 km/h (3 mph)

*** NOTICE**

If the operating conditions are satisfied, there will be a warning whenever the vehicle approaches from the left or right side even though your vehicle speed is 0 km/h (0 mph).

Emergency Braking



- Your vehicle, the warning light on the side view mirror (outside mirror) will blink and a warning message will appear on the cluster. At the same time, an audible warning will sound.
- The function will operate when the following conditions are satisfied:
 - Your vehicle gear is shifted to R (Reverse)
 - Your vehicle speed is below 8 km/h (5 mph)
 - The approaching vehicle is within approximately 1.5 m (5 ft.) from the left and right side of your vehicle
 - The speed of the vehicle approaching from the left and right is above 5 km/h (3 mph)

- Emergency braking will be assisted to help prevent collision with approaching vehicles from the left and right.

⚠ WARNING

- Brake control will end when:
 - The approaching vehicle is out of the detecting range
 - The approaching vehicle passes behind your vehicle
 - The approaching vehicle does not drive toward your vehicle
 - The approaching vehicle speed slows down
 - The driver depresses the brake pedal with sufficient power

Stopping vehicle and ending brake control

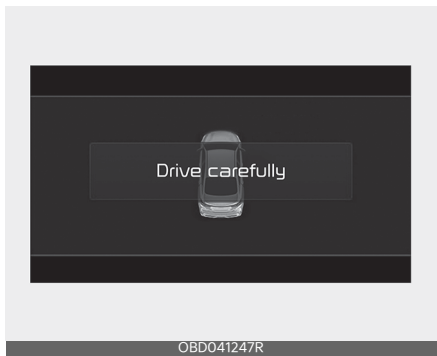

- When the vehicle is stopped due to emergency braking, the 'Drive carefully' warning message will appear on the cluster.
- For your safety, the driver should depress the brake pedal immediately and check the surroundings.
- Brake control will end after the vehicle is stopped by emergency braking for approximately 2 seconds.

- During emergency braking, braking control by the function will automatically cancel when the driver excessively depresses the brake pedal.

⚠ WARNING

- For your safety, change the settings after parking the vehicle at a safe location.
- If any other function's warning message is displayed or audible warning is generated, Rear Cross-Traffic Safety system warning message may not be displayed and audible warning may not be generated.
- You may not hear the warning sound of Rear Cross-Traffic Safety system if the surrounding is noisy.
- Rear Cross-Traffic Safety system may not operate if the driver applies the brake pedal to avoid collision.
- During Rear Cross-Traffic Safety system operation, the vehicle may stop suddenly injuring passengers and shifting loose objects. Always have the seat belt on and keep loose objects secured.
- Even if there is a problem with Rear Cross-Traffic Safety system, the vehicle's basic braking performance will operate normally.

⚠ WARNING

- During emergency braking, braking control by the function will automatically cancel when the driver excessively depresses the accelerator pedal.
- Rear Cross-Traffic Safety system does not operate in all situations or cannot avoid all collisions.
- Rear Cross-Traffic Safety system may warn the driver late or may not warn

the driver depending on the road and driving conditions.

- The driver should hold the responsibility to control the vehicle. Do not solely depend on Rear Cross-Traffic Safety system. Rather, maintain a safe braking distance, and if necessary, depress the brake pedal to reduce driving speed or to stop the vehicle.
- Never deliberately operate Rear Cross-Traffic Safety system on people, animal, objects, etc. It may cause serious injury or death.

⚠ CAUTION

The brake control may not operate properly depending on the status of ESC (Electronic Stability Control). There will only be a warning when:

- The ESC (Electronic Stability Control) warning light is on
- ESC (Electronic Stability Control) is engaged in a different function

*** NOTICE**

The driver must immediately depress the brake pedal and check vehicle surroundings.

- Brake control will end when the driver depresses the brake pedal with sufficient power.
- After shifting the gear to R (Reverse), braking control will operate once for left and right vehicle approach.

Rear Cross-Traffic Collision-Avoidance Assist malfunction and limitations

Rear Cross-Traffic Collision-Avoidance Assist malfunction

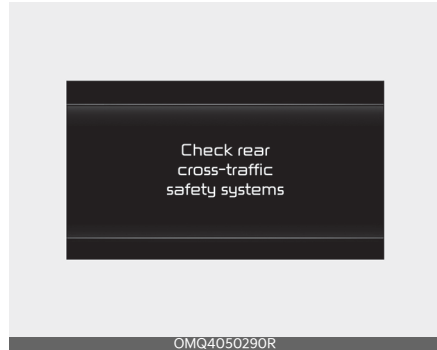

When Rear Cross-Traffic Safety system is not working properly, the 'Check rear cross-traffic safety system' warning message will appear (turns off after a certain time), and the  warning light will illuminate on the cluster. We recommend that you have your vehicle inspected by an authorised Kia dealer/service partner.

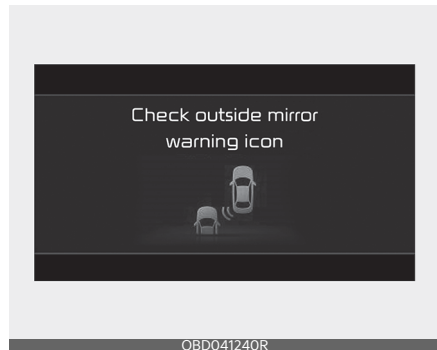

When the warning light on the side view mirror (outside mirror) is not working properly, the 'Check outside mirror warning icon' warning message will

appear (turns off after a certain time), and the  warning light will illuminate on the cluster. We recommend that you have your vehicle inspected by an authorised Kia dealer/service partner.

Rear Cross-Traffic Collision-Avoidance Assist disabled

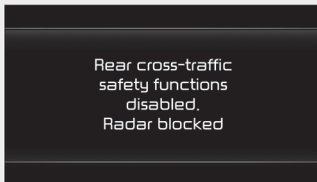

OMQ4050292R

When the rear bumper around the rear corner radar or sensor is covered with foreign matters, such as snow or rain, or installing a trailer or carrier, it can reduce the detecting performance and temporarily limit or disable Rear Cross-Traffic Safety system.

If this occurs, the 'Rear cross-traffic safety functions disabled. Radar blocked' warning message will appear on the cluster. It is not a malfunction. The function will operate normally when such foreign matters or trailer, etc. is removed.

Always keep the rear view camera and rear ultrasonic sensors clean.

If the function does not operate normally after it is removed, We recommend that you have your vehicle inspected by an authorised Kia dealer/service partner.

WARNING

- Even though the warning message does not appear on the cluster, Rear Cross-Traffic Safety system may not properly operate.
- Rear Cross-Traffic Safety system may not properly operate in an area (e.g. open terrain), where any substance are not detected after turning ON the engine.

CAUTION

Turn off Rear Cross-Traffic Safety system to install a trailer, carrier, etc., and remove the trailer, carrier, etc. to use Rear Cross-Traffic Safety system.

Limitations of Rear Cross-Traffic Collision-Avoidance Assist

Rear Cross-Traffic Safety system may not operate normally, or the function may operate unexpectedly under the following circumstances:

- Departing from where trees or grass is overgrown
- Departing from where roads are wet
- Speed of the approaching vehicle is fast or slow

Braking control may not work, driver's attention is required in the following circumstances:

- The vehicle severely vibrates whilst driving over a bumpy road, uneven road or concrete patch
- Driving on a slippery surface due to snow, water puddle, ice, etc.
- The tyre pressure is low or a tyre is damaged
- The brake is reworked

*** NOTICE**

For more details on the limitations of the rear corner radar, refer to "Blind-Spot Collision-Avoidance Assist (BCA) (if equipped)" on page 6-94.

⚠ WARNING

- **Driving near a vehicle or structure**

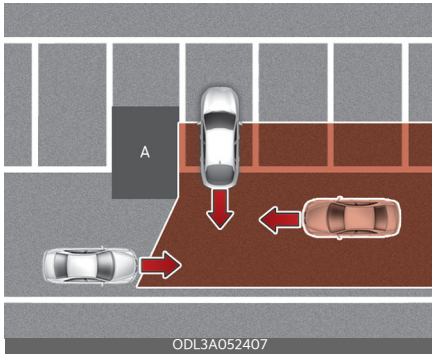

[A]: Structure

Rear Cross-Traffic Safety system may be limited when driving near a vehicle or structure, and may not detect the vehicle approaching from the left or right. If this occurs, the function may not warn the driver or control the brakes when necessary.

Always check your surroundings whilst backing up.

- **When the vehicle is in a complex parking environment**

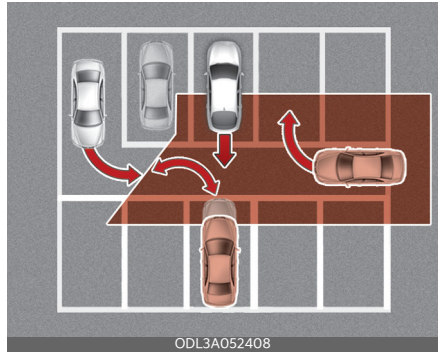

Rear Cross-Traffic Safety system may detect vehicles which are parking or pulling out near your vehicle (e.g. a vehicle leaving beside your vehicle, a vehicle parking or pulling out in the rear area, a vehicle approaching your vehicle making a turn, etc.). If this occurs, the function may unnecessarily warn the driver and control the brake.

Always check your surroundings whilst backing up.

[A]: Vehicle

- **When the vehicle is parked diagonally**

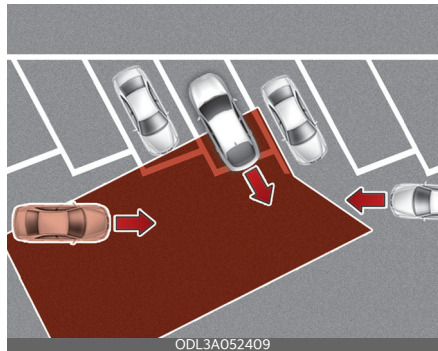

Rear Cross-Traffic Safety system may be limited when backing up diagonally, and may not detect the vehicle approaching

from the left or right. If this occurs, the function may not warn the driver or control the brakes when necessary.

Always check your surroundings whilst backing up.

- **When the vehicle is on or near a slope**

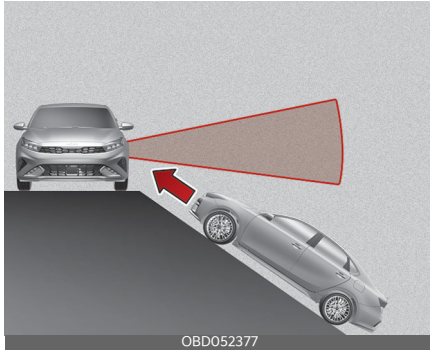

Rear Cross-Traffic Safety system may be limited when the vehicle is on an uphill or downhill slope, or near it, and may not detect the vehicle approaching from the left or right. If this occurs, the function may not warn the driver or control the brakes when necessary.

Always check your surroundings whilst backing up.

⚠ WARNING

- **Pulling into the parking space where there is a structure**

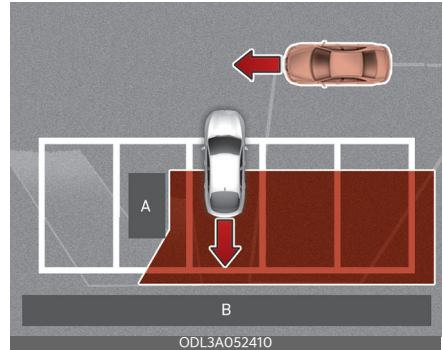

[A]: Structure, [B]: Wall

Rear Cross-Traffic Safety system may detect vehicles passing by in front of you when parking backwards into a parking space with a wall or structure in the rear or side area. If this occurs, the function may unnecessarily warn the driver and control the brake.

Always check your surroundings whilst backing up.

- **When the vehicle is parked rearward**

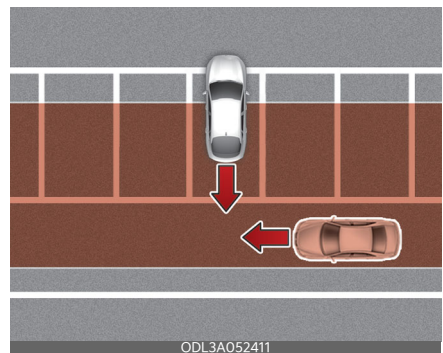

Rear Cross-Traffic Safety system may detect vehicles passing by behind you when parking backwards into a parking space. If this occurs, the function may unnecessarily warn the driver and control the brake.

Always check your surroundings whilst backing up.

WARNING

- When you are towing a trailer or another vehicle, we recommend that Rear Cross-Traffic Safety system is turned off due to safety reasons.
- Rear Cross-Traffic Safety system may not operate normally if interfered by strong electromagnetic waves.
- Rear Cross-Traffic Safety system may not operate for 3 seconds after the vehicle is started, or the rear corner radars are initialized.

Declaration of conformity (if equipped)

The radio frequency components (Front Radar) complies:

Europe and countries subject to CE certification

Hereby, Robert Bosch GmbH declares that the radio equipment type MRRevo14F is in compliance with Directive 2014/53/EU. The full text of the EU declaration of conformity is available at the following internet address: <http://eu-doc.bosch.com>. Please enter the Model as MRRevo14F to find the correct DoC in the database.

(DE) EU-KONFORMITÄTSERKLÄRUNG
Hiermit erklärt Robert Bosch GmbH, dass der Funkanlagentyp MRRevo14F der Richtlinie 2014/53/EU entspricht. Der vollständige Text der EU-Konformitätserklärung ist unter der folgenden Internetadresse verfügbar: <http://eu-doc.bosch.com>

(BG) ЕС ДЕКЛАРАЦИЯ ЗА СЪОТВЕТСТВИЕ
С настоящото Robert Bosch GmbH декларира, че този тип радиосъоръжение MRRevo14F е в съответствие с Директива 2014/53/ЕС. Цялостният текст на ЕС декларацията за съответствие може да се намери на следния интернет адрес: <http://eu-doc.bosch.com>

(HR) EU IZJAVA O SUKLADNOSTI
Robert Bosch GmbH ovime izjavljuje da je radijska oprema tipa MRRevo14F u skladu s Direktivom 2014/53/EU. Cjeloviti tekst EU izjave o sukladnosti dostupan je na sljedećoj internetskoj adresi: <http://eu-doc.bosch.com>

OBDO51322

(EL) ΔΗΛΩΣΗ ΣΥΜΜΟΡΦΩΣΗΣ ΕΕ
Με την παρούσα ο/η Robert Bosch GmbH, δηλώνει ότι ο ραδιοεξοπλισμός MRRevo14F πληροί την οδηγία 2014/53/ΕΕ. Το πλήρες κείμενο της δήλωσης συμμόρφωσης ΕΕ διατίθεται στην ακόλουθη ιστοσελίδα στο διαδίκτυο: <http://eu-doc.bosch.com>

(CS) EU PROHLÁŠENÍ O SHODĚ
Tímto Robert Bosch GmbH prohlašuje, že typ rádiového zařízení MRRevo14F je v souladu se směrnicí 2014/53/EU. Úplné znění EU prohlášení o shodě je k dispozici na této internetové adrese: <http://eu-doc.bosch.com>

(DA) EU-OVERENSSTEMMELSEERKLÆRING
Hermed erklærer Robert Bosch GmbH, at radioudstyrstypen MRRevo14F er i overensstemmelse med direktiv 2014/53/EU. EU-overensstemmelseserklæringens fulde tekst kan findes på følgende internetadresse: <http://eu-doc.bosch.com>

(ET) ELI VASTAVUSDEKLARATSIOON
Käesolevaga deklareerib Robert Bosch GmbH, et käesolev raadioseadme tüüp MRRevo14F vastab direktiivi 2014/53/EÜ nõuetele. ELI vastavusdeklaratsiooni täielik tekst on kättesaadav järgmisel Internetiaadressil: <http://eu-doc.bosch.com>

OBD051323

(FI) EU-VAATIMUSTENMUKAISUUSVAKUUTUS
Robert Bosch GmbH vakuuttaa, että radiolaitetyypin MRRevo14F on direktiivin 2014/53/EU mukainen. EU-vaatimustenmukaisuusvakuutuksen täysimittainen teksti on saatavilla seuraavassa internetosoitteessa: <http://eu-doc.bosch.com>

(FR) DECLARATION UE DE CONFORMITE
Le soussigné, Robert Bosch GmbH, déclare que l'équipement radioélectrique du type MRRevo14F est conforme à la directive 2014/53/UE. Le texte complet de la déclaration UE de conformité est disponible à l'adresse internet suivante: <http://eu-doc.bosch.com>

(HU) EU-MEGFELELŐSÉGI NYILATKOZAT
Robert Bosch GmbH igazolja, hogy a MRRevo14F típusú rádióberendezés megfelel a 2014/53/EU irányelvnek. Az EU-megfelelőségi nyilatkozat teljes szövege elérhető a következő internetes címen: <http://eu-doc.bosch.com>

(IT) DICHIARAZIONE DI CONFORMITÀ UE
Il fabbricante, Robert Bosch GmbH, dichiara che il tipo di apparecchiatura radio MRRevo14F è conforme alla direttiva 2014/53/UE. Il testo completo della dichiarazione di conformità UE è disponibile al seguente indirizzo Internet: <http://eu-doc.bosch.com>

OBD051324

(LV) ES ATBILSTĪBAS DEKLARĀCIJA
Ar šo Robert Bosch GmbH deklarē, ka radioelektrā MRRevo14F atbilst Direktīvai 2014/53/ES. Pilns ES atbilstības deklarācijas teksts ir pieejams šādā Interneta vietnē: <http://eu-doc.bosch.com>

(LT) ES ATITIKTIES DEKLARACIJA
Aš, Robert Bosch GmbH, patvirtinu, kad radijo įrenginių tipas MRRevo14F atitinka Direktyvą 2014/53/ES. Visas ES atitikties deklaracijos tekstas prieinamas šiuo interneto adresu: <http://eu-doc.bosch.com>

(MT) DIKJARAZZJONI TA' KONFORMITÀ TAL-UE
B'dan, Robert Bosch GmbH, niddikjara li dan it-tip ta' taghmir tar-radju MRRevo14F huwa konformi mad-Direttiva 2014/53/UE. It-test kollu tad-dikjarazzjoni ta' konformità tal-UE huwa disponibbli f'dan l-indirizz tal-Internet li gej: <http://eu-doc.bosch.com>

(NL) EU-CONFORMITEITSVERKLARING
Hierbij verklaar ik, Robert Bosch GmbH, dat het type radioapparatuur MRRevo14F conform is met Richtlijn 2014/53/EU. De volledige tekst van de EU-conformiteitsverklaring kan worden geraadpleegd op het volgende internetadres: <http://eu-doc.bosch.com>

(PL) DEKLARACJA ZGODNOŚCI UE
Robert Bosch GmbH niniejszym oświadcza, że typ urządzenia radiowego MRRevo14F jest zgodny z dyrektywą 2014/53/UE. Pełny tekst deklaracji zgodności UE jest dostępny pod następującym adresem internetowym: <http://eu-doc.bosch.com>

OBD051325

(PT) DECLARAÇÃO UE DE CONFORMIDADE
O(a) abaixo assinado(a) Robert Bosch GmbH declara que o presente tipo de equipamento de rádio MRRevo14F está em conformidade com a Diretiva 2014/53/UE. O texto integral da declaração de conformidade está disponível no seguinte endereço de Internet: <http://eu-doc.bosch.com>

(RO) DECLARAȚIA UE DE CONFORMITATE
Prin prezenta, Robert Bosch GmbH declară că tipul de echipamente radio MRRevo14F este în conformitate cu Directiva 2014/53/UE. Textul integral al declarației UE de conformitate este disponibil la următoarea adresă internet: <http://eu-doc.bosch.com>

(SK) EÚ VYHLÁSENIE O ZHODE
Robert Bosch GmbH týmto vyhlasuje, že rádiové zariadenie typu MRRevo14F je v súlade so smernicou 2014/53/EÚ. Úplné EÚ vyhlásenie o zhode je k dispozícii na tejto internetovej adrese: <http://eu-doc.bosch.com>

(SL) IZJAVA EU O SKLADNOSTI
Robert Bosch GmbH potrjuje, da je tip radijske opreme MRRevo14F skladen z Direktivo 2014/53/EU. Celotno besedilo izjave EU o skladnosti je na voljo na naslednjem spletnem naslovu: <http://eu-doc.bosch.com>

OBD051326

(ES) DECLARACIÓN UE DE CONFORMIDAD
Por la presente, Robert Bosch GmbH declara que el tipo de equipo radioeléctrico MRRevo14F es conforme con la Directiva 2014/53/UE. El texto completo de la declaración UE de conformidad está disponible en la dirección Internet siguiente: <http://eu-doc.bosch.com>

(SV) EU-FÖRSÄKRAN OM ÖVERENSSTÄMMELSE
Härmed försäkras Robert Bosch GmbH att denna typ av radioutrustning MRRevo14F överensstämmer med direktiv 2014/53/EU. Den fullständiga texten till EU-försäkran om överensstämmelse finns på följande webbadress: <http://eu-doc.bosch.com>

OBD051327

For United States and American territories, Micronesia, Dominican Republic, Honduras



OYB060040L

FCC ID: NF3-MRREVO14F

User manual statement according to §15.19:

NOTICE:
This device complies with Part 15 of the FCC Rules

Operation is subject to the following two conditions:

- (1) this device may not cause harmful interference, and
- (2) this device must accept any interference received, including interference that may cause undesired operation.

User manual statement according to §15.21:
Changes or modifications made to this equipment not expressly approved by Robert BOSCH GmbH may void the FCC authorization to operate this equipment.

OBD051328

User manual statements according to §15.105:
This equipment has been tested and found to comply with the limits for a Class A digital device, pursuant to Part 15 of the FCC Rules. These limits are designed to provide reasonable protection against harmful interference when the equipment is operated in a commercial environment.
This equipment generates, uses, and can radiate radio frequency energy and, if not installed and used in accordance with the instruction manual, may cause harmful interference to radio communications.
Operation of this equipment in a residential area is likely to cause harmful interference in which case the user will be required to correct the interference at his own expense.

RF Exposure Information according 2.1091 / 2.1093 / KDB 447498 / OET bulletin 65:

Radiofrequency radiation exposure

Information:

This equipment complies with FCC radiation exposure limits set forth for an uncontrolled environment.

This equipment should be installed and operated with minimum distance of 20 cm between the radiator and your body.

This transmitter must not be co-located or operating in conjunction with any other antenna or transmitter.

OBD051329

For Canada

Model: MRRevo14F
IC: 3887A-MRREVO14F

User manual statement according to RSS-GEN

NOTICE:

This device complies with Industry Canada license-exempt RSS standard(s). Operation is subject to the following two conditions: (1) this device must not cause interference, and (2) this device must accept any interference, including interference that may cause undesired operation of the device. Le présent appareil est conforme aux CNR d'Industrie Canada applicables aux appareils radio exempts de licence. L'exploitation est autorisée aux deux conditions suivantes: (1) l'appareil ne doit pas produire de brouillage, et (2) l'utilisateur de l'appareil doit accepter tout brouillage radioélectrique subi, même si le brouillage est susceptible d'en compromettre le fonctionnement.

OBD051330

RF Exposure Information according to RSS-102

Radiofrequency radiation exposure Information:

This equipment complies with FCC and IC radiation exposure limits set forth for an uncontrolled

environment. This equipment should be installed and operated with minimum distance of 20 cm between the radiator and your body.

This transmitter must not be co-located or operating in conjunction with any other antenna or transmitter.

Cet équipement est conforme aux limites d'exposition aux rayonnements IC établies pour un

environnement non contrôlé. Cet équipement doit être installé et utilisé avec un minimum de 20 cm de

distance entre la source de rayonnement et votre corps.

Ce transmetteur ne doit pas être placé au même endroit ou utilisé simultanément avec un autre transmetteur ou antenne.

OBD051331

For Japan

当該機器には電波法に基づく、技術基準適合証明等を受けた特定無線設備を装着している。本無線機器の改造を禁ずる(これに反した場合は当該認証登録番号は無効となる)

OBD051332

For South Korea

[Class B Equipment]

등급 기기 (가정용 방송통신기자재)

이 기기는 가정용(등급) 전자파의합기로서 주로 가정에서 사용하는 것을 목적으로 하며, 모든 지역에서 사용할 수 있습니다.

[RF Warnings]

필요 무선 설비는 운용 중 전파혼신 가능성이 있음

OBD051333

For South Africa

TA-2013/2465



APPROVED

OBD051336

For Hong Kong

HKCA 1035: automotive radar: radio equipment exempted from licensing!

OBD051334

For Taiwan



CCEA E15LP0180T0

OBD051337

For United Arab Emirates

TRA
REGISTERED No:
ER39135/15

DEALER No:
DA36758/14

OBD051335

注意!

依據低功率電波輻射性電機管理辦法
第十二條經型式認證合格之低功率射頻電機，
非經許可，公司、商號或使用者均不得擅自變
更頻率、加大
功率或變更原設計之特性及功能。
第十四條低功率射頻電機之使用不得影響飛航
安全及干擾合法通信；經發現有干擾現象時，
應立即停用，
並改善至無干擾時方得繼續使用。前項合法通
信，指依電信規定作業之無線電通信。低功率射
頻電機須忍受
合法通信或工業、科學及醫療用電波輻射性電
機設備之干擾。

OBD051338

For Brazil



Este equipamento opera em caráter secundário, isto é, não tem direito a proteção contra interferência prejudicial, mesmo de estações do mesmo tipo, e não pode causar interferência a sistemas operando em caráter primário.

OBD051340

For Moldova



For Ukraine



For Serbia



For Morocco

AGREE PAR L'ANRT MAROC

Numéro d'agrément : MR 9126 ANRT 2014

Date d'agrément : 26/03/2014

OBD051344

For Philippines



NTC

Type Approved
No. ESD-1408747C

OBD051345

For Malaysia



MCMC

CIDF15000490

OBD051349

For Mexico

IFETEL: RCPBOMR14-0766

OBD051346

La operación de este equipo está sujeta a las siguientes dos condiciones:
(1) es posible que este equipo o dispositivo no cause interferencia perjudicial y
(2) este equipo o dispositivo debe aceptar cualquier interferencia, incluyendo la que pueda causar su operación no deseada.

OBD051347

For Singapore

Complies with
IMDA Standards
DA105282

OBD051350

6

For Jordan

TRC No. TRC/LPD/2014/125

OBD051348

For Australia



OBD051351

For Thailand



Class A

NBTC ID. A57004-14-XXXX

This telecommunication equipment "BOSCH Radar Sensor MRRevo14F" conforms to technical standard NTC TS 1011-2549.

This telecommunication equipment "BOSCH Radar Sensor MRRevo14F" has EMF radiation and conforms to NTC exposure standard NTC TS 5001-2550.

This equipment "BOSCH Radar Sensor MRRevo14F" is operating more than 20cm away from human body in normal operating condition.

OBD051352

For Russia



OBD051355

For Paraguay



OBD051356

For Argentina



OBD051353

For China



OBD051354

The radio frequency components (Rear Corner Radar) complies:

For United States and American territories, Micronesia, Dominican Republic, Honduras



OYB060040L

This device complies with Part 15 of the FCC Rules. Operation is subject to the following two conditions:

- (1) this device may not cause harmful interference, and
- (2) this device must accept any interference received, including interference that may cause undesired operation.

CAUTION TO USERS

Changes or modifications not expressly approved by the party responsible for compliance could void the user's authority to operate the equipment.

OBD061079L

For Canada

Model: BSD 3.0
IC: 2694A-BSD30

This device contains licence-exempt transmitter(s)/receiver(s) that comply with Innovation, Science and Economic Development Canada's licence-exempt RSS(s). Operation is subject to the following two conditions:

- (1) This device may not cause interference.
- (2) This device must accept any interference, including interference that may cause undesired operation of the device.;

Le présent appareil est conforme aux CNR d'Industrie Canada applicables aux appareils radio exempts de licence. L'exploitation est autorisée aux deux conditions suivantes:

- (1) l'appareil ne doit pas produire de brouillage, et
- (2) l'utilisateur de l'appareil doit accepter tout brouillage radioélectrique subi, même si le brouillage est susceptible d'en compromettre le fonctionnement.

This equipment complies with ISED radiation exposure limits set forth for an uncontrolled environment. This equipment should be installed and operated with minimum distance of 20 cm between the radiator and your body. This transmitter must not be co-located or operating in conjunction with any other antenna or transmitter. Cet équipement est conforme aux limites d'exposition aux rayonnements ISED établies pour un environnement non contrôlé. Cet équipement doit être installé et utilisé avec un minimum de 20 cm de distance entre la source de rayonnement et votre corps. Ce transmetteur ne doit pas être placé au même endroit ou utilisé simultanément avec un autre transmetteur ou antenne.

OBD061080L

For Taiwan

電信法第 48 條、低功率電波輻射性電機管理辦法
 第十二條
 經型式認證合格之低功率射頻電機，非經許可，公司、商號或使用者均不得擅自變更頻率、加大功率或變更原設計之特性及功能。
 第十四條
 低功率射頻電機之使用不得影響飛航安全及干擾合法通信；經發現有干擾現象時，應立即停用，並改善至無干擾時方得繼續使用。
 前項合法通信，指依電信法規定作業之無線電通信。低功率射頻電機須忍受合法通信或工業、科學及醫療用電波輻射性電機設備之干擾。

Article 12
 Without permission, any company, firm or user shall not alter the frequency, increase the power, or change the characteristics and functions of the original design of the certified lower power frequency electric machinery.
 Article 14
 The application of low power frequency electric machineries shall not affect the navigation safety nor interface a legal communication, if an interference is found, the service will be suspended until improvement is made and the interference no longer exist.

OYB060043L

For Malaysia



OYB060045L

For Singapore

Complies with
 IMDA Standards
 DA 103238

OYB060046L

For Vietnam



OBD061081L

For Brazil



OBD061082L

Este equipamento não tem direito à proteção contra interferência prejudicial e não pode causar interferência em sistemas devidamente autorizados

OYB060049L

For Mexico

Radar de corto alcance
BSD3.0
Hella KGaA Hueck & Co
IFETEL: RLVMABS15-1854

“La operación de este equipo está sujeta a las siguientes dos condiciones:

(1) es posible que este equipo o dispositivo no cause interferencia perjudicial y (2) este equipo o dispositivo debe aceptar cualquier interferencia, incluyendo la que pueda causar su operación no deseada.”

OBD061083L

For Ukraine



UA RF: 1HELABS D3

OBD061084L

Цим HELLA GmbH & Co. KGaA заявляє, що радіотехнічне обладнання типу BSD3.0 відповідає Технічному регламенту радіотехнічного обладнання та Директиві 2014/53/ЄС.

Повний текст декларації про відповідність доступний за адресою: www.hella.com/hyundai

Частотний діапазон: 24,05 – 24,25 ГГц
Потужність передачі: 20 дБм (макс.) EIRP

OBD061085L

For Jordan

TRC No. TRC/LPD/2014/9

OBD061086L

For Oman

OMAN - TRA
TRA/TA-R/1630/13
D100428

OBD061087L

For United Arab Emirates

TRA
Registered No:
ER51643/17
Dealer No:
DA44932/15

OBD061088L

For Korea

1. 상호: 만도헬라일렉트로닉스 주식회사
 2. 기기명칭 및 모델명
 - 기기명칭: 물체감지센서용 무선기기
 (24GHz 주파수대를 사용하는 기기)
 - 모델명: LCA Master Gen3/ Slave Gen3
 3. 제조자 및 제조국가
 - 제조자: 만도헬라일렉트로닉스 주식회사
 - 제조국가: 한국

OBD061089L

Europe and countries subject to CE certification

In the user manual :

Hereby, Hella KgaA Hueck & Co. Declares that the radio equipment type Gen3.0 is in compliance with Directive 2014/53/EU. The full text of the EU declaration of conformity is available at the following internet address:
www.hella.com/hyundai

Technical information:
 Frequency range: 24.05 ... 24.25 GHz
 Transmission power: 20 dBm (maximum)
 EIRP

Manufacturer and Address:
 Hella KGaA Hueck & Co.
 Rixbecker Straße 75, 59552 Lippstadt,
 Germany

OBD061090L

For China

车辆管理辅助雷达系统型号: BSD 3.0型
 微功率射频无线电传输设备分类: H类
 频率范围: 24.05-24.25GHz
 发射功率: 20mW (等效全向辐射功率)
 天线类型: 集成印制带贴片阵列天线
 阻抗控制: 正常
 使用温度: -40~+85° C
 电压: DC 9.0-16.0V

不得随意更改发射频率、发射功率(包括额外加发射功率的大功率)。不得随意外泄无线电波或其它射频辐射。使用时不得对各种合法的无线电通信业务产生有害干扰;一旦发现有干扰现象时,应立即停止使用,并采取措施消除干扰后方可继续使用。

不得使用功率过大的无线电设备,必须避免各种无线业务的干扰或工业、科学及医疗应用设备的辐射干扰。机场等的电磁环境保护区域内使用微功率设备,应当遵守电磁环境保护及相关行业主管部门的规定。

不得在飞机和机场附近使用。

OBD061091L

For Israel

לכבוד :
רמי יובל
הרמת השרון
רונדליים הייז 32
4448483
דוא"ר : ramicos@ramicos.co.il

תאריך הדפסה : 01/07/2019
חיק מספר : 63-67180

חשבונית מס' 54-22989 - פג"מ - פג"מ

מספר חשבונית	תאריך	סכום	מספר חשבונית
51127799	01/07/2020	9999	51127799

1. שירותי תחבורה וניהול רכב
2. ארנונית
3. ארנונית
4. ארנונית
5. ארנונית
6. ארנונית
7. ארנונית
8. ארנונית
9. ארנונית
10. ארנונית
11. ארנונית
12. ארנונית
13. ארנונית
14. ארנונית

01/07/2020
מספר חשבונית: 54-22989

OBD061092L

Economical operation

Your vehicle's fuel economy depends mainly on your style of driving, where you drive and when you drive.

Each of these factors affects how many kilometers (miles) you can get from a litre (gallon) of fuel. To operate your vehicle as economically as possible, use the following driving suggestions to help save money in both fuel and repairs:

- Drive smoothly. Accelerate at a moderate rate. Don't make "jackrabbit" starts or full-throttle shifts and maintain a steady cruising speed. Don't race between stoplights. Try to adjust your speed to the traffic so you don't have to change speeds unnecessarily. Avoid heavy traffic whenever possible.

For Thailand

กรมการขนส่งทางบก
nabn.

เครื่องวิทยุคมนาคมนี้ ได้รับวัน ไม้ต้องได้รับ ใบอนุญาตให้ใช้ ซึ่งเครื่องวิทยุคมนาคม หรือตั้งสถานีวิทยุคมนาคมตามประกาศ กทท. เรื่อง เครื่องวิทยุคมนาคม และสถานีวิทยุคมนาคมที่ได้รับวัน ไม้ต้องได้รับใบอนุญาตวิทยุคมนาคม ตามพระราชบัญญัติวิทยุคมนาคม พ.ศ. 2498

nabn. โทรคมนาคม
Call Center 1200 (Inx&S)

OBD061093L

Always maintain a safe distance from other vehicles so you can avoid unnecessary braking. This also reduces brake wear.

- Drive at a moderate speed. The faster you drive, the more fuel your vehicle uses. Driving at a moderate speed, especially on the highway, is one of the most effective ways to reduce fuel consumption.
- Don't "ride" the brake pedal. This can increase fuel consumption and also increase wear on these components. In addition, driving with your foot resting on the brake pedal may cause the brakes to overheat, which reduces their effectiveness and may lead to more serious consequences.
- Take care of your tyres. Keep them inflated to the recommended pressure. Incorrect inflation, either too much or too little, results in unnecessary tyre wear. Check the tyre pressures at least once a month.

6

- Be sure that the wheels are aligned correctly. Improper alignment can result from hitting kerbs or driving too fast over irregular surfaces. Poor alignment causes faster tyre wear and may also result in other problems as well as greater fuel consumption.
- Keep your car in good condition. For better fuel economy and reduced maintenance costs, maintain your car in accordance with the maintenance schedule in section 8. If you drive your car in severe conditions, more frequent maintenance is required (see section 8 for details).
- Keep your car clean. For maximum service, your vehicle should be kept clean and free of corrosive materials. It is especially important that mud, dirt, ice, etc. not be allowed to accumulate on the underside of the car. This extra weight can result in increased fuel consumption and also contribute to corrosion.
- Travel lightly. Don't carry unnecessary weight in your car. Weight reduces fuel economy.
- Don't let the engine idle longer than necessary. If you are waiting (and not in traffic), turn off your engine and restart only when you're ready to go.
- Remember, your vehicle does not require extended warm-up. After the engine has started, allow the engine to run for 10 to 20 seconds prior to placing the vehicle in gear. In very cold weather, however, give your engine a slightly longer warmup period.
- Don't "lug" or "over-rev" the engine. Lugging is driving too slowly in too high a gear resulting in the engine bucking. If this happens, shift to a

lower gear. Over-revving is racing the engine beyond its safe limit. This can be avoided by shifting at the recommended speeds.

- Use your air conditioning sparingly. The air conditioning system is operated by engine power so your fuel economy is reduced when you use it.
- Open windows at high speeds can reduce fuel economy.
- Fuel economy is less in crosswinds and headwinds. To help offset some of this loss, slow down when driving in these conditions.

Keeping a vehicle in good operating condition is important both for economy and safety. Therefore, have the system serviced by a professional workshop.

Kia recommends to visit an authorised Kia dealer/service partner.

WARNING

Engine off during motion

Never turn the engine off to coast down hills or anytime the vehicle is in motion. The power steering and power brakes will not function properly without the engine running. Instead, keep the engine on and downshift to an appropriate gear for engine braking effect. In addition, turning off the ignition whilst driving could engage the steering wheel lock resulting in loss of vehicle steering which could cause serious injury or death.

Special driving conditions

Hazardous driving conditions

When hazardous driving conditions are encountered such as water, snow, ice, mud, sand, or similar hazards, follow these suggestions:

- Drive cautiously and allow extra distance for braking.
- Avoid sudden braking or steering.
- When braking with non-ABS brakes pump the brake pedal with a light up-and-down motion until the vehicle is stopped.

WARNING

ABS

Do not pump the brake pedal on a vehicle equipped with ABS.

- If stalled in snow, mud, or sand, use second gear. Accelerate slowly to avoid spinning the drive wheels.
- Use sand, rock salt, tyre chains, or other non-slip material under the drive wheels to provide traction when stalled in ice, snow, or mud.

Rocking the vehicle

If it is necessary to rock the vehicle to free it from snow, sand, or mud, first turn the steering wheel right and left to clear the area around your front wheels. Then, shift back and forth between 1st (First) and R (Reverse) in vehicles equipped with a Manual Transmission R (Reverse) and any forward gear in vehicles equipped with an Automatic Transmission/Automated manual transmission. Do not race the engine, and spin the wheels as little as possible. If you are still stuck after a few tries, have the vehicle pulled out by a tow

vehicle to avoid engine overheating and possible damage to the transmission.

CAUTION

Prolonged rocking may cause engine over-heating, transmission damage or failure, and tyre damage.

WARNING

Spinning tyres

Do not spin the wheels, especially at speeds more than 56 km/h (35 mph). Spinning the wheels at high speeds when the vehicle is stationary could cause a tyre to overheat which could result in tyre damage that may injure bystanders.

NOTICE

The ESC system should be turned OFF prior to rocking the vehicle.

WARNING

If your vehicle becomes stuck in snow, mud, sand, etc., then you may attempt to rock the vehicle free by moving it forward and backward. Do not attempt this procedure if people or objects are anywhere near the vehicle. During the rocking operation the vehicle may suddenly move forward or backward as it becomes unstuck, causing injury or damage to nearby people or objects.

Smooth cornering



Avoid braking or gear changing in corners, especially when roads are wet. Ideally, corners should always be taken under gentle acceleration. If you follow these suggestions, tyre wear will be held to a minimum.

Driving at night



Because night driving presents more hazards than driving in the daylight, here are some important tips to remember:

- Slow down and keep more distance between you and other vehicles, as it may be more difficult to see at night, especially in areas where there may not be any street lights.

- Adjust your mirrors to reduce the glare from other driver's headlights.
- Keep your headlights clean and properly aimed on vehicles not equipped with the automatic headlight aiming feature. Dirty or improperly aimed headlights will make it much more difficult to see at night.
- Avoid staring directly at the headlights of oncoming vehicles. You could be temporarily blinded, and it will take several seconds for your eyes to readjust to the darkness.

Driving in the rain



Rain and wet roads can make driving dangerous, especially if you're not prepared for the slick pavement. Here are a few things to consider when driving in the rain:

- A heavy rainfall will make it harder to see and will increase the distance needed to stop your vehicle, so slow down.
- Keep your windscreen wiping equipment in good shape. Replace your windscreen wiper blades when they show signs of streaking or missing areas on the windscreen.
- If your tyres are not in good condition, making a quick stop on wet pavement

can cause a skid and possibly lead to an accident. Be sure your tyres are in good shape.

- Turn on your headlights to make it easier for others to see you.
- Driving too fast through large puddles can affect your brakes. If you must go through puddles, try to drive through them slowly.
- If you believe you may have gotten your brakes wet, apply them lightly whilst driving until normal braking operation returns.

Driving in flooded areas

Avoid driving through flooded areas unless you are sure the water is no higher than the bottom of the wheel hub. Drive through any water slowly. Allow adequate stopping distance because brake performance may be affected.

After driving through water, dry the brakes by gently applying them several times whilst the vehicle is moving slowly.

Driving off-road

Drive carefully off-road because your vehicle may be damaged by rocks or roots of trees. Become familiar with the off-road conditions where you are going to drive before you begin driving.

Highway driving

Tyres



Adjust the tyre inflation pressures to specification. Low tyre inflation pressures will result in overheating and possible failure of the tyres.

Avoid using worn or damaged tyres which may result in reduced traction or tyre failure.

* NOTICE

Never exceed the maximum tyre inflation pressure shown on the tyres.

⚠ WARNING

Underinflated or overinflated tyres can cause poor handling, loss of vehicle control, and sudden tyre failure leading to accidents, injuries, and even death. Always check tyres for proper inflation before driving. For proper tyre pressures, refer to "Tyres and wheels" on page 8-55.

Fuel, engine coolant and engine oil

High speed travel consumes more fuel than urban motoring. Do not forget to check both engine coolant and engine oil.

Drive belt

A loose or damaged drive belt may result in overheating of the engine.

Winter driving

More severe weather conditions of winter result in greater wear and other problems. To minimise winter driving problem, you should follow these suggestions:



OBD051049

Summer tyres

Kia specifies summer tyres on some models to provide superior performance on dry roads. Summer tyre performance is substantially reduced in snow and ice. Summer tyres do not have the tyre traction rating M+S (Mud and Snow) on the tyre side wall. If you plan to operate your vehicle in snowy or icy conditions, Kia recommends the use of snow tyres or all season tyres on all four wheels.

Snowy or icy conditions

To drive your vehicle in deep snow, it may be necessary to use snow tyres or to install tyre chains on your tyres. If snow tyres are needed, it is necessary to select tyres equivalent in size and type of the original equipment tyres. Failure to do so may adversely affect the safety and handling of your car. Furthermore, speeding, rapid acceleration, sudden brake applications, and sharp turns are potentially very hazardous practices.

During deceleration, use engine braking to the fullest extent. Sudden brake applications on snowy or icy roads may cause skids to occur. You need to keep sufficient distance between the vehicle in operation in front and your vehicle. Also, apply the brake gently. It should be noted that installing tyre chains on the tyre will provide a greater driving force, but will not prevent side skids.

* NOTICE

Tyre chains are not legal in all countries. Check the country laws before fitting tyre chains.

Snow tyres

If you mount snow tyres on your vehicle, make sure they are radial tyres of the same size and load range as the original tyres. Mount snow tyres on all four wheels to balance your vehicle's handling in all weather conditions. Keep in mind that the traction provided by snow tyres on dry roads may not be as high as your vehicle's original equipment tyres. You should drive cautiously even when the roads are clear. Check with the tyre dealer for maximum speed recommendations.

⚠ WARNING

Snow tyre size

Snow tyres should be equivalent in size and type to the vehicle's standard tyres. Otherwise, the safety and handling of your vehicle may be adversely affected.

Do not install studded tyres without first checking local, state and municipal regulations for possible restrictions against their use.

Tyre chains



Since the sidewalls of radial tyres are thinner, they can be damaged by mounting some types of snow chains on them. Therefore, the use of snow tyres is recommended instead of snow chains. Do not mount tyre chains on vehicles equipped with aluminum wheels; snow chains may cause damage to the wheels. If snow chains must be used, use wire-type chains with a thickness of less than 15 mm (0.59 in). Damage to your vehicle caused by improper snow chain use is not covered by your vehicle manufacturer's warranty.

Install tyre chains only on the front tyres.

⚠ CAUTION

- Make sure the snow chains are the correct size and type for your tyres. Incorrect snow chains can cause damage to the vehicle body and suspension and may not be covered by your vehicle manufacturer warranty. Also, the snow chain connecting hooks may be damaged from contacting vehicle components causing the snow chains to come loose from the tyre. Make sure the snow chains are SAE class "S" certified.

- Always check chain installation for proper mounting after driving approximately 0.5 to 1 km (0.3 to 0.6 miles) to ensure safe mounting. Retighten or remount the chains if they are loose.
- Even with the appropriate chain installed, do not make a full turn (turn the steering wheel fully to one side) when driving the vehicle. (If you are making a full turn, drive with the speed below 10km/h.)

Chain installation

When installing chains, follow the manufacturer's instructions and mount them as tightly as you can. Drive slowly with chains installed. If you hear the chains contacting the body or chassis, stop and tighten them. If they still make contact, slow down until it stops. Remove the chains as soon as you begin driving on cleared roads.

WARNING

Mounting chains

When mounting snow chains, park the vehicle on level ground away from traffic. Turn on the vehicle Hazard Warning flashers and place a triangular emergency warning device behind the vehicle if available. Always place the vehicle in P (Park), apply the parking brake and turn off the engine before installing snow chains.

WARNING

Tyre chains

- The use of chains may adversely affect vehicle handling.
- Do not exceed 30 km/h (20 mph) or the chain manufacturer's recom-

mended speed limit, whichever is lower.

- Drive carefully and avoid bumps, holes, sharp turns, and other road hazards, which may cause the vehicle to bounce.
- Avoid sharp turns or locked wheel braking.

CAUTION

- Chains that are the wrong size or improperly installed can damage your vehicle's brake lines, suspension, body and wheels.
- Stop driving and retighten the chains any time you hear them hitting the vehicle.

Use high quality ethylene glycol coolant

Your vehicle is delivered with high quality ethylene glycol coolant in the cooling system. It is the only type of coolant that should be used because it helps prevent corrosion in the cooling system, lubricates the water pump and prevents freezing. Be sure to replace or replenish your coolant in accordance with the maintenance schedule in section 8.

Before winter, have your coolant tested to assure that its freezing point is sufficient for the temperatures anticipated during the winter.

Check battery and cables

Winter puts additional burdens on the battery system. Visually inspect the battery and cables as described in section 8. Have the level of charge in your battery checked by a professional workshop. Kia recommends to visit an authorised Kia dealer/service partner.

Change to "winter weight" oil if necessary

In some climates it is recommended that a lower viscosity "winter weight" oil be used during cold weather. See section 9 for recommendations. If you aren't sure what weight oil you should use, Kia recommends to consult an authorised Kia dealer/service partner.

Check spark plugs and ignition system

Inspect your spark plugs as described in section 8 and replace them if necessary. Also check all ignition wiring and components to be sure they are not cracked, worn or damaged in any way.

To keep locks from freezing

To keep the locks from freezing, squirt an approved de-icer fluid or glycerine into the key opening. If a lock is covered with ice, squirt it with an approved de-icing fluid to remove the ice. If the lock is frozen internally, you may be able to thaw it out by using a heated key. Handle the heated key with care to avoid injury.

Use approved window washer anti-freeze in system

To keep the water in the window washer system from freezing, add an approved window washer anti-freeze solution in accordance with instructions on the container. Window washer anti-freeze is available from an authorised Kia dealer/service partner and most auto parts outlets. Do not use engine coolant or other types of anti-freeze as these may damage the paint finish.

Don't let your parking brake freeze

Under some conditions your parking brake can freeze in the engaged position. This is most likely to happen when there is an accumulation of snow or ice around or near the rear brakes or if the brakes are wet. When there is the risk that your parking brake may freeze, temporarily apply it with the shift lever in P (Automatic Transmission) in first or reverse gear (for Manual Transmission). Also, block the rear wheels in advance, so the vehicle may not roll. Then, release the parking brake.

Don't let ice and snow accumulate underneath

Under some conditions, snow and ice can build up under the fenders and interfere with the steering. When driving in severe winter conditions where this may happen, you should periodically check underneath the car to be sure the movement of the front wheels and the steering components is not obstructed.

Carry emergency equipment

Depending on the severity of the weather, you should carry appropriate emergency equipment. Some of the items you may want to carry include tyre chains, tow straps or chains, flashlight, emergency flares, sand, shovel, jumper cables, window scraper, gloves, ground cloth, coveralls, blanket, etc.

Drive your vehicle when water vapour condenses and accumulates inside the exhaust pipes

When the vehicle is stopped for a long time in winter whilst the engine is running, water vapour may condense and accumulate inside the exhaust pipes. Water in the exhaust pipes may cause

noise, etc., but it is drained driving at medium to high speed.

Trailer Towing (if equipped)

If you are considering towing with your vehicle, you should first check with your country's Department of Motor Vehicles to determine their legal requirements.

Since laws vary the requirements for towing trailers, cars, or other types of vehicles or apparatus may differ. Kia recommends to ask an authorised Kia dealer/service partner.

WARNING

Towing a trailer

If you don't use the correct equipment and/or drive improperly, you can lose control when you pull a trailer. For example, if the trailer is too heavy, the brakes may not work well - or even at all. You and your passengers could be seriously or fatally injured. Pull a trailer only if you have followed all the steps in this section.

WARNING

Weight limits

Before towing, make sure the total trailer weight, GCW (gross combination weight), GVW (gross vehicle weight), GAW (gross axle weight) and trailer tongue load are all within the limits.

NOTICE

- The technically permissible maximum load on the rear axle(s) may be exceeded by not more than 15 % and the technically permissible maximum laden mass of the vehicle may be exceeded by not more than 10 % or 100 kg (220.4 lbs), whichever value is lower. In this case, do not exceed 100 km/h (60 mph) for vehicle of category

M1 or 80 km/h (50 mph) for vehicle of category N1.

- When towing a trailer, the additional load imposed at the trailer coupling device may cause the rear tyre maximum load ratings to be exceeded, but not by more than 15%. In such a case, do not exceed 100 km/h (60 mph), and the rear tyre pressure should be at least 20 kPa(0.2 bar) above the tyre pressure(s) as recommended for normal use (i.e. without a trailer attached).

⚠ CAUTION

Pulling a trailer improperly can damage your vehicle and result in costly repairs not covered by your warranty. To pull a trailer correctly, follow the advice.

Your vehicle can tow a trailer. To identify what the vehicle trailering capacity is for your vehicle, you should read the information in weight of the trailer refer to "Trailer Towing (if equipped)" on page 6-172.

Remember that trailering is different than just driving your vehicle by itself. Trailering means changes in handling, durability, and fuel economy. Successful, safe trailering requires correct equipment, and it has to be used properly. This section contains many time-tested, important trailering tips and safety rules. Many of these are important for your safety and that of your passengers. Please read this section carefully before you pull a trailer.

Load-pulling components such as the engine, transmission, wheel assemblies, and tyres are forced to work harder against the load of the added weight. The engine is required to operate at rela-

tively higher speeds and under greater loads. This additional burden generates extra heat. The trailer also considerably adds wind resistance, increasing the pulling requirements.

* NOTICE

Location of trailer mounting

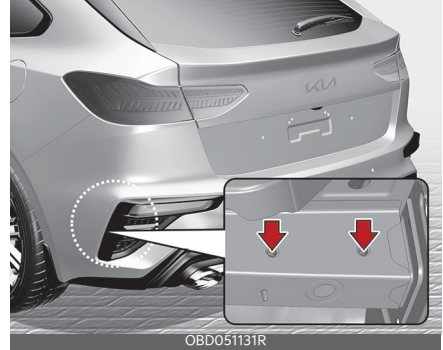

The mounting hole for hitches is located on both sides of the underbody behind the rear tyres.

Hitches

It's important to have the correct hitch equipment. Crosswinds, large trucks going by, and rough roads are a few reasons why you'll need the right hitch. Here are some rules to follow:

- Do you have to make any holes in the body of your vehicle when you install a trailer hitch? If you do, then be sure to seal the holes later when you remove the hitch.
- If you do not seal them, deadly carbon monoxide (CO) from your exhaust can get into your vehicle, as well as dirt and water.
- The bumpers on your vehicle are not intended for hitches. Do not attach rental hitches or other bumper-type hitches to them. Use only a frame-

mounted hitch that does not attach to the bumper.

- Any part of the rear number plate or lighting devices of the vehicle must not be obscured by the mechanical coupling device.

If the rear number plate and/or lighting devices can be obscured partially by any part of the mechanical coupling device, mechanical coupling devices that can not be easily removed or repositioned without use of any tools, except an easily operated (i.e. an effort not exceeding 20Nm) release key which is supplied by the manufacturer of the coupling device, are not permitted for use.

Please note that the mechanical coupling device that is fitted and not in use must always be removed or repositioned if the rear number plate and/or rear lighting devices are obscured by any part of the mechanical coupling device.

- Kia trailer hitch accessory is available at an authorised Kia dealer/service partner.

Safety chains

You should always attach chains between your vehicle and your trailer. Cross the safety chains under the tongue of the trailer so that the tongue will not drop to the road if it becomes separated from the hitch.

Instructions about safety chains may be provided by the hitch manufacturer or by the trailer manufacturer. Follow the manufacturer's recommendation for attaching safety chains. Always leave just enough slack so you can turn with your trailer. And, never allow safety chains to drag on the ground.

Trailer brakes

If your trailer is equipped with a braking system, make sure it conforms to your country's regulations and that it is properly installed and operating correctly.

If your trailer weight exceeds the maximum allowed weight without trailer brakes, then the trailer will also require its own brakes as well. Be sure to read and follow the instructions for the trailer brakes so you'll be able to install, adjust and maintain them properly.

- Do not tap into or modify your vehicle's brake system.

WARNING

Trailer brakes

Do not use a trailer with its own brakes unless you are absolutely certain that you have properly set up the brake system. This is not a task for amateurs. Use an experienced, competent trailer shop for this work.

Driving with a trailer

Towing a trailer requires a certain amount of experience. Before setting out for the open road, you must get to know your trailer. Acquaint yourself with the feel of handling and braking with the added weight of the trailer. And always keep in mind that the vehicle you are driving is now a good deal longer and not nearly so responsive as your vehicle is by itself.

Before you start, check the trailer hitch and platform, safety chains, electrical connector(s), lights, tyres and mirror adjustment. If the trailer has electric brakes, start your vehicle and trailer moving and then apply the trailer brake controller by hand to be sure the brakes

are working. This lets you check your electrical connection at the same time. During your trip, check occasionally to be sure that the load is secure, and that the lights and any trailer brakes are still working.

Following distance

Stay at least twice as far behind the vehicle ahead as you would when driving your vehicle without a trailer. This can help you avoid situations that require heavy braking and sudden turns.

Passing

You'll need more passing distance up ahead when you're towing a trailer. And, because of the increased vehicle length, you'll need to go much farther beyond the passed vehicle before you can return to your lane.

Backing up

Hold the bottom of the steering wheel with one hand. Then, to move the trailer to the left, just move your hand to the left. To move the trailer to the right, move your hand to the right. Always back up slowly and, if possible, have someone guide you.

Making turns

When you're turning with a trailer, make wider turns than normal. Do this so your trailer won't strike soft shoulders, kerbs, road signs, trees, or other objects near the edge of the road. Avoid jerky or sudden manoeuvres. Signal well in advance before turning or lane changes.

Turn signals when towing a trailer

When you tow a trailer, your vehicle has to have a different turn signal flasher and extra wiring. The green arrows on your instrument panel will flash whenever you signal a turn or lane change. Properly connected, the trailer lights will also flash to alert other drivers you're about to turn, change lanes, or stop.

When towing a trailer, the green arrows on your instrument panel will flash for turns even if the bulbs on the trailer are burned out. Thus, you may think drivers behind you are seeing your signals when, in fact, they are not. It is important to check occasionally to be sure the trailer bulbs are still working. You must also check the lights every time you disconnect and then reconnect the wires.

Do not connect a trailer lighting system directly to your vehicle's lighting system. Use only an approved trailer wiring harness.

Have yourself assisted by a professional workshop in installing the wiring harness. Kia recommends to visit an authorised Kia dealer/service partner.

WARNING

Failure to use an approved trailer wiring harness could result in damage to the vehicle electrical system and/or personal injury.

Driving on grades

Reduce speed and shift to a lower gear before you start down a long or steep downgrade. If you don't shift down, you might have to use your brakes so much that they would get hot and no longer operate efficiently.

On a long uphill grade, shift down and reduce your speed to around 70 km/h (45 mph) to reduce the possibility of engine and transmission overheating. If your trailer weighs more than the maximum trailer weight without trailer brakes and you have an automatic transmission, you should drive in D (Drive) when towing a trailer.

Operating your vehicle in D (Drive) when towing a trailer will minimise heat build up and extend the life of your transmission.

⚠ CAUTION

- When towing a trailer on steep grades (in excess of 6%) pay close attention to the engine coolant temperature gauge to ensure the engine does not overheat.

If the needle of the coolant temperature gauge moves across the dial towards "130/H (HOT)", pull over and stop as soon as it is safe to do so, and allow the engine to idle until it cools down. You may proceed once the engine has cooled sufficiently.

- You must decide driving speed depending on trailer weight and uphill grade to reduce the possibility of engine and transmission overheating.

Parking on hills

Generally, if you have a trailer attached to your vehicle, you should not park your vehicle on a hill. People can be seriously or fatally injured, and both your vehicle and the trailer can be damaged if they unexpectedly roll down hill.

⚠ WARNING

Parking on a hill

Parking your vehicle on a hill with a trailer attached could cause serious injury or death, should the trailer break loose or the brake stops working.

Do not apply the accelerator pedal to hold the vehicle on an uphill.

However, if you ever have to park your trailer on a hill, here is how to do it:

1. Pull the vehicle into the parking space. Turn the steering wheel in the direction of the kerb (left if headed down hill, left if headed up hill).
2. If the vehicle has an automatic transmission, place the car in P (Park).
3. Set the parking brake and shut off the vehicle.
4. Place chocks under the trailer wheels on the down hill side of the wheels.
5. Start the vehicle, hold the brakes, shift to neutral, release the parking brake and slowly release the brakes until the trailer chocks absorb the load.
6. Reapply the brakes, reapply the parking brake and shift the vehicle to P (Park) for automatic transmission.
7. Shut off the vehicle and release the vehicle brakes but leave the parking brake set.

* NOTICE

Vehicles equipped with a dual clutch transmission when towing a trailer on steep grades, need to be aware that the clutch in the transmission could overheat. When the clutch is overheated, the safe protection mode engages. If the safe protection mode engages, the gear position indicator on the cluster blinks with a chime sound. At this time, a warn-

ing message will appear on the LCD display and driving may not be smooth. If you ignore this warning, the driving condition may become worse. To return to normal driving conditions, stop the vehicle on a flat road and apply the foot brake for a few minutes before driving off.

WARNING

Parking brake

It can be dangerous to get out of your vehicle if the parking brake is not firmly set.

If you have left the engine running, the vehicle can move suddenly. You or others could be seriously or fatally injured.

When you are ready to leave after parking on a hill

1. With gear in P (Park), apply your brakes and hold the brake pedal down whilst you:
 - Start your engine;
 - Shift into gear; and
 - Release the parking brake.
2. Slowly remove your foot from the brake pedal.
3. Drive slowly until the trailer is clear of the chocks.
4. Stop and have someone pick up and store the chocks.

Maintenance when trailer towing

Your vehicle will need service more often when you regularly pull a trailer. Important items to pay particular attention to include engine oil, automatic transmission fluid, axle lubricant and cooling system fluid. Brake condition is another important item to frequently

check. Each item is covered in this manual, and the Index will help you find them quickly. If you're trailering, it is a good idea to review these sections before you start your trip.

Do not forget to also maintain your trailer and hitch. Follow the maintenance schedule that accompanied your trailer and check it periodically. Preferably, conduct the check at the start of each day's driving. Most importantly, all hitch nuts and bolts should be tight.

CAUTION

- Due to higher load during trailer usage, overheating might occur in hot days or during uphill driving. If the coolant gauge indicates overheating, switch off the air conditioner and stop the vehicle in a safe area to cool down the engine.
- When towing check transmission fluid more frequently.
- If your vehicle is not equipped with an air conditioner, you should install a condenser fan to improve engine performance when towing a trailer.

If you do decide to pull a trailer

Here are some important points if you decide to pull a trailer:

- Consider using a sway control. You can ask a hitch dealer about sway control.
- Do not do any towing with your car during its first 2,000 km (1,200 miles) in order to allow the engine to properly break in. Failure to heed this caution may result in serious engine or transmission damage.
- When towing a trailer, Kia recommends that you consult an authorised Kia dealer/service partner on addi-

tional requirements such as a towing kit, etc.

- Always drive your vehicle at a moderate speed (less than 100 km/h (60 mph)).
- On a long uphill grade, do not exceed 70 km/h (45 mph) or the posted towing speed limit, whichever is lower.
- The chart contains important considerations that have to do with weight:

For Australia and New Zealand

Item		(Petrol) 1.6 T-GDI	(Petrol) 2.0 MPI	
		DCT	6M/T	6A/T
Maximum trailer weight kg (lbs.)	Without brake System	610 (1,344)	610 (1,344)	610 (1,344)
	With brake System	1,100 (2,425)	1,200 (2,645)	1,100 (2,425)
Maximum permissible static vertical load on the coupling device kg (lbs.)		75 (165)		
Recommended distance from rear wheel centre to coupling point mm (inch)		- 4 Door : 1,115 (43.9) - 5 Door : 985 (38.8)		

Weight of the trailer

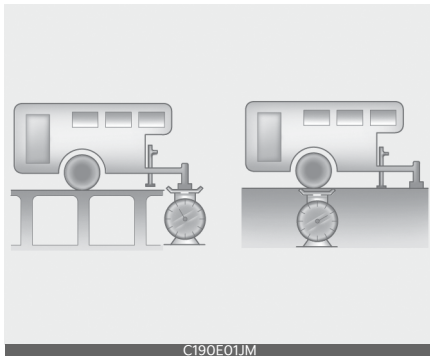

C190E01JM

What is the maximum safe weight of a trailer? It should never weigh more than the maximum trailer weight with trailer brakes. But even that can be too heavy. It depends on how you plan to use your trailer. For example, speed, altitude, road grades, outside temperature and how often your vehicle is used to pull a trailer are all important. The ideal trailer weight can also depend on any special equipment that you have on your vehicle.

Weight of the trailer tongue

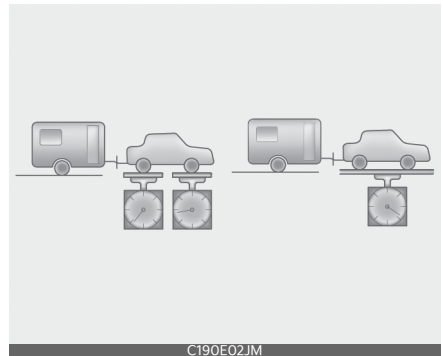

C190E02JM

The tongue load of any trailer is an important weight to measure because it affects the total gross vehicle weight (GVW) of your vehicle. This weight includes the kerb weight of the vehicle, any cargo you may carry in it, and the people who will be riding in the vehicle. And if you will tow a trailer, you must add the tongue load to the GVW because your vehicle will also be carrying that weight.

The trailer tongue should weigh a maximum of 10% of the total loaded trailer weight, within the limits of the maximum permissible trailer tongue load.

After you've loaded your trailer, weigh the trailer and then the tongue, separately, to see if the weights are proper. If they aren't, you may be able to correct them simply by moving some items around in the trailer.

WARNING

Trailer

- Never load a trailer with more weight in the rear than in the front. The front should be loaded with approximately 60% of the total trailer load; the rear should be loaded with approximately 40% of the total trailer load.
- Never exceed the maximum weight limits of the trailer or trailer towing equipment. Improper loading can result in damage to your vehicle and/or personal injury. Check weights and loading at a commercial scale or highway patrol office equipped with scales.
- An improperly loaded trailer can cause loss of vehicle control.

NOTICE

With increasing altitude the engine performance decreases. From 1,000m above sea level and for every 1,000m there after 10% of vehicle/trailer weight (trailer weight + gross vehicle weight) must be deducted.

Vehicle weight

This section will guide you in the proper loading of your vehicle, to keep your loaded vehicle weight within its design rating capability. Properly loading your vehicle will provide maximum return of the vehicle design performance. Before loading your vehicle, familiarize yourself with the following terms for determining your vehicle's weight ratings, from the vehicle's specifications and the certification label:

Base kerb weight

This is the weight of the vehicle including a full tank of fuel and all standard equipment. It does not include passengers, cargo, or optional equipment.

Vehicle kerb weight

This is the weight of your new vehicle when you picked it up from your dealer plus any aftermarket equipment.

Cargo weight

This figure includes all weight added to the Base kerb Weight, including cargo and optional equipment.

GAW (Gross axle weight)

This is the total weight placed on each axle (front and rear) - including vehicle kerb weight and all payload.

GAWR (Gross axle weight rating)

This is the maximum allowable weight that can be carried by a single axle (front or rear). These numbers are shown on the certification label. (if equipped)

The total load on each axle must never exceed its GAWR.

GVW (Gross vehicle weight)

This is the Base kerb Weight plus actual Cargo Weight plus passengers.

GVWR (Gross vehicle weight rating)

This is the maximum allowable weight of the fully loaded vehicle (including all options, equipment, passengers and cargo). The GVWR is shown on the certification label located on the driver's (or front passenger's) door sill. (if equipped)

Overloading

WARNING

Vehicle weight

The gross axle weight rating (GAWR) and the gross vehicle weight rating (GVWR) for your vehicle are on the certification label attached to the driver's (or front passenger's) door. Exceeding these ratings can cause an accident or vehicle damage. You can calculate the weight of your load by weighing the items (and people) before putting them in the vehicle. Be careful not to overload your vehicle.

Loading Your Vehicle - For Australia

Certification Label (Type A)- if equipped

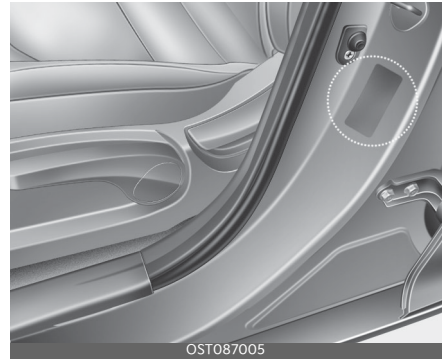

OST087005

Certification Label (Type B)- if equipped

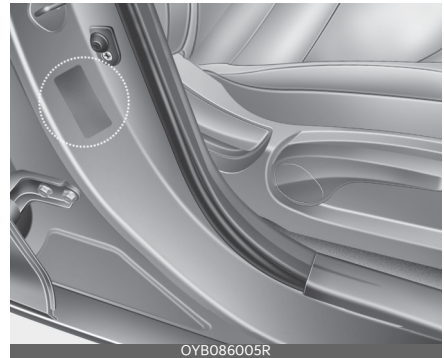

OYB086005R

Tyre Label

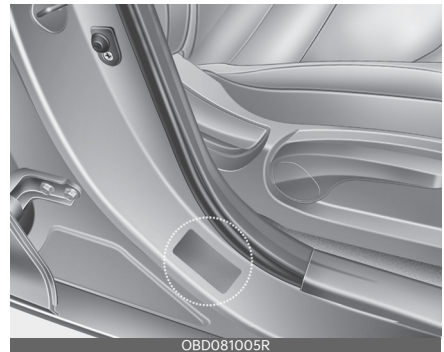

OBD081005R

The Certification/Tyre label is found on the front edge of the RH (or LH) "B" pillar. The label shows the size of your original tyres and inflation pressures needed to obtain the gross weight capacity of your vehicle.

This is called the GVWR (Gross Vehicle Weight Rating). The GVWR includes the weight of the vehicle, all occupants, fuel and cargo. The Certification/Tyre label also tells you the maximum weights for the front and rear axles, called Gross Axle Weight Rating (GAWR).

Never exceed the GVWR for your vehicle, or the Gross Axle Weight Rating (GAWR) for either the front or rear axle. And, if you do have a heavy load, you should spread it out.

NOTICE

Your warranty does not cover parts or components that fail because of overloading.

WARNING

Do not load your vehicle any heavier than the GVWR or the maximum front and rear GAWRs. If you do, change to the vehicle may occur, or it can change the way your vehicle handles. These could cause you to lose control. Also, overloading can shorten the life of your vehicle.

What to do in an emergency

Road warning	7-2
• Hazard warning flasher.....	7-2
In case of an emergency whilst driving	7-2
• If the engine stalls at a crossroad or crossing.....	7-2
• If you have a flat tyre whilst driving.....	7-2
• If engine stalls whilst driving.....	7-3
If the engine will not start	7-3
• If engine doesn't turn over or turns over slowly.....	7-3
• If engine turns over normally but does not start.....	7-3
Emergency starting	7-4
• Jump starting.....	7-4
• Push-starting.....	7-5
If the engine overheats	7-6
Tyre Pressure Monitoring System (TPMS)	7-7
• System Overview.....	7-7
• TPMS Setting.....	7-7
• Indication of Low Tyre Pressure.....	7-8
• Tyre Pressure Monitoring System malfunction.....	7-9
• Reference : Indicator Light Status.....	7-10
If you have a flat tyre (with spare tyre)	7-10
• Jack and tools.....	7-10
• Removing and storing the spare tyre.....	7-11
• Changing tyres.....	7-11
• Jack label.....	7-16
• EC Declaration of Conformity for Jack.....	7-17
Towing	7-18
• Towing service.....	7-18
• Removable towing hook.....	7-18
• Emergency towing.....	7-19
Emergency Commodity	7-22

What to do in an emergency

Road warning

Hazard warning flasher

The hazard warning flasher serves as a warning to other drivers to exercise extreme caution when approaching, overtaking, or passing your vehicle.

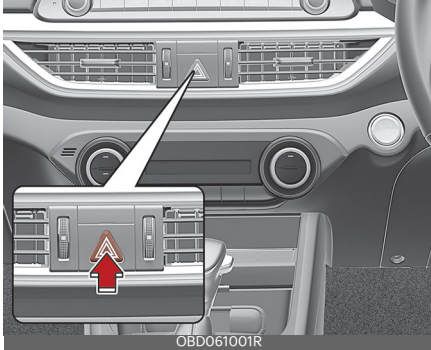

It should be used whenever emergency repairs are being made or when the vehicle is stopped near the edge of a roadway.

Depress the flasher switch with the ignition switch or ENGINE START/STOP button in any position. The flasher switch is located in the centre console switch panel. All turn signal lights will flash simultaneously.

- The hazard warning flasher operates whether your vehicle is running or not.
- The turn signals do not work when the hazard flasher is on.
- Care must be taken when using the hazard warning flasher whilst the vehicle is being towed.

In case of an emergency whilst driving

If the engine stalls at a crossroad or crossing

- If the engine stalls at a crossroad or crossing, set the shift lever in the N (Neutral) position and then push the vehicle to a safe place.
- If your vehicle has a manual transmission not equipped with an ignition lock switch, the vehicle can move forward by shifting to the 2 (second) or 3 (third) gear and then turning the starter without depressing the clutch pedal.

If you have a flat tyre whilst driving

If a tyre goes flat whilst you are driving:

1. Take your foot off the accelerator pedal and let the vehicle slowdown whilst driving straight ahead.
Do not apply the brakes immediately or attempt to pull off the road as this may cause a loss of control. When the vehicle has slowed down to such a speed that it is safe to do so, brake carefully and pull off the road. Drive off the road as far as possible and park on a firm level ground. If you are on a divided highway, do not park in the median area between the two traffic lanes.
2. When the vehicle is stopped, turn on your emergency hazard flashers, set the parking brake and put the transmission in P (automatic transmission) or reverse (manual transmission).
3. Have all passengers get out of the vehicle. Be sure they all get out on the side of the vehicle that is away from traffic.

4. When changing a flat tyre, follow the instruction provided later in this section.

If engine stalls whilst driving

1. Reduce your speed gradually, keeping a straight line. Move cautiously off the road to a safe place.
2. Turn on your emergency flashers.
3. Try to start the engine again. If your vehicle does not start, consult a professional workshop. Kia recommends to consult an authorised Kia dealer/service partner.

If the engine will not start

If engine doesn't turn over or turns over slowly

1. If your vehicle has automatic transmission/dual clutch transmission, be sure the shift lever is in N (Neutral) or P (Park) and the emergency brake is set.
2. Check the battery connections to be sure they are clean and tight.
3. Turn on the interior light. If the light dims or goes out when you operate the starter, the battery is discharged.
4. Check the starter connections to be sure they are securely tightened.
5. Do not push or pull the vehicle to start it. See instructions for "Jump starting".

WARNING

If the engine will not start, do not push or pull the vehicle to start it. This could result in a collision or cause other damage. In addition, push or pull starting may cause the catalytic converter to be overloaded and create a fire hazard.

If engine turns over normally but does not start

1. Check the fuel level.
2. With the ignition switch or ENGINE START/STOP button in the LOCK/OFF position, check all connectors at the ignition coils and spark plugs. Reconnect any that may be disconnected or loose.
3. Check the fuel line in the engine compartment.
4. If the engine still does not start, call a professional workshop. Kia recommends to call an authorised Kia dealer/service partner.

Emergency starting

Connect cables in numerical order and disconnect in reverse order.

(Petrol) 1.6 MPI

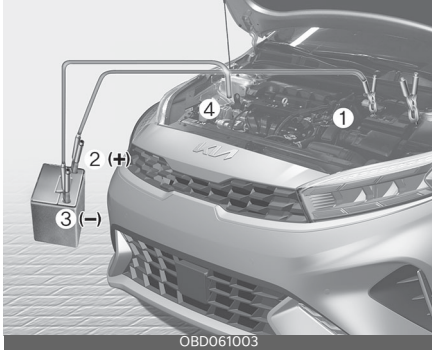

Smartstream G1.6

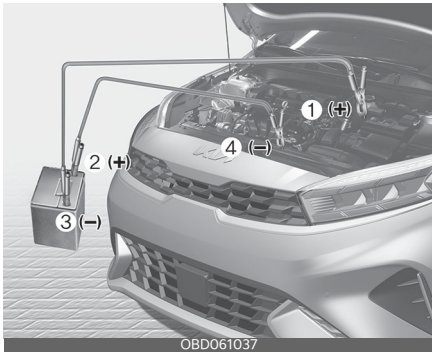

Jump starting

Jump starting can be dangerous if done incorrectly. Therefore, to avoid harm to yourself or damage to your vehicle or battery, follow the jump starting procedures. If in doubt, we strongly recommend that you have a competent technician or towing service jump start your vehicle.

⚠ CAUTION

Use only a 12-volt jumper system. You can damage a 12-volt starting motor,

ignition system, and other electrical parts beyond repair by use of a 24-volt power supply (either two 12-volt batteries in series or a 24-volt motor generator set)

⚠ WARNING

Battery

Never attempt to check the electrolyte level of the battery as this may cause the battery to rupture or explode causing serious injury.

⚠ WARNING

Battery

- Keep all flames or sparks away from the battery. The battery produces hydrogen gas which may explode if exposed to flame or sparks.

If these instructions are not followed exactly, serious personal injury and damage to the vehicle may occur! If you are not sure how to follow this procedure, seek qualified assistance. Automobile batteries contain sulfuric acid.

This is poisonous and highly corrosive. When jump starting, wear protective glasses and be careful not to get acid on yourself, your clothing or on the vehicle.

- Do not attempt to jump start the vehicle if the discharged battery is frozen or if the electrolyte level is low; the battery may rupture or explode.
- Do not allow the (+) and (-) jumper cables to touch. It may cause sparks.
- The battery may rupture or explode when you jump start with a low or frozen battery.

Jump starting procedure

1. Make sure the booster battery is 12-volt and that its negative terminal is grounded.
2. If the booster battery is in another vehicle, do not allow the vehicles come in contact.
3. Turn off all unnecessary electrical loads.
4. Connect the jumper cables in the exact sequence shown in the illustration. First connect one end of a jumper cable to the positive terminal of the discharged battery (1), then connect the other end to the positive terminal on the booster battery (2). Proceed to connect one end of the other jumper cable to the negative terminal of the booster battery (3), then the other end to a solid, stationary, metallic point (for example, the engine lifting bracket) away from the battery (4). Do not connect it to or near any part that moves when the engine is cranked.

Do not allow the jumper cables to contact anything except the correct battery terminals or the correct ground. Do not lean over the battery when making connections.

CAUTION

Battery cables

Do not connect the jumper cable from the negative terminal of the booster battery to the negative terminal of the discharged battery. This can cause the discharged battery to overheat and crack, releasing battery acid. Make sure to connect one end of the jumper cable to the negative terminal of the booster

battery, and the other end to a metallic point, far away from the battery.

5. Start the engine of the vehicle with the booster battery and let it run at 2,000 rpm, then start the engine of the vehicle with the discharged battery.

If the cause of your battery discharging is not apparent, have the system checked by a professional workshop. Kia recommends to visit an authorised Kia dealer/service partner.

Push-starting

Your manual transmission-equipped vehicle should not be push-started because it might damage the emission control system.

Vehicles equipped with automatic transmission/dual clutch transmission cannot be push-started.

Follow the directions in this section for jump-starting.

WARNING

Never tow a vehicle to start it because the sudden surge forward when the engine starts could cause a collision with the tow vehicle.

If the engine overheats

If your temperature gauge indicates overheating, you will experience a loss of power, or hear loud pinging or knocking, the engine is probably too hot. If this happens, you should:

1. Pull off the road and stop as soon as it is safe to do so.
2. Place the shift lever in P (for automatic transmission/dual clutch transmission) or neutral (manual transmission) and set the parking brake. If the air conditioning is on, turn it off.
3. If engine coolant is running out under the vehicle or steam is coming out from the bonnet, stop the engine. Do not open the bonnet until the coolant has stopped running or the steaming has stopped. If there is no visible loss of engine coolant and no steam, leave the engine running and check to be sure the engine cooling fan is operating. If the fan is not running, turn the engine off.
4. Check to see if the water pump drive belt is missing. If it is not missing, check to see that it is tight.
If the drive belt seems to be satisfactory, check for coolant leaking from the radiator, hoses or under the vehicle. (If the air conditioning had been in use, it is normal for cold water to be draining from it when you stop).

WARNING

Whilst the engine is running, keep hair, hands and clothing away from moving parts such as the fan and drive belts to prevent injury.

5. If the water pump drive belt is broken or engine coolant is leaking out, stop

the engine immediately and call a professional workshop. Kia recommends to call an authorised Kia dealer/service partner.

WARNING

Do not remove the radiator cap when the engine is hot. This can allow coolant to blow out of the opening and cause serious burns.

6. If you cannot find the cause of the overheating, wait until the engine temperature has returned to normal. Then, if coolant has been lost, carefully add coolant to the reservoir to bring the fluid level in the reservoir up to the halfway mark.
7. Proceed with caution, keeping alert for further signs of overheating. If overheating happens again, call a professional workshop. Kia recommends to call an authorised Kia dealer/service partner.

CAUTION

- Serious loss of coolant indicates there is a leak in the cooling system. In this case, have the system checked by a professional workshop. Kia recommends to visit an authorised Kia dealer/service partner.
- When the engine overheats from low engine coolant, suddenly adding engine coolant may cause cracks in the engine. To prevent damage, add engine coolant slowly in small quantities.

Tyre Pressure Monitoring System (TPMS) (if equipped)

Low tyre pressure telltale



TPMS SET button

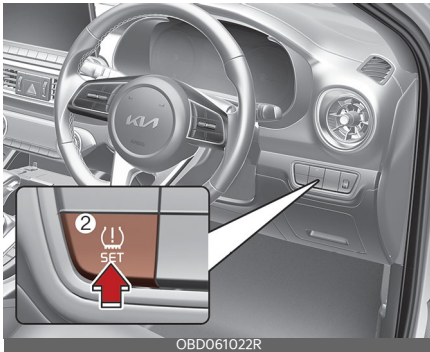

System Overview

The tyre pressure monitoring system (TPMS) senses change in radius of the tyre. If the tyre pressure decreases below the recommended pressure, the system warning light will be illuminated. For the system to function properly, it is the driver's responsibility to set the system by following accurate procedure and set current tyre pressure.

The warning light will illuminate on the cluster when one or more of your tyres is under-inflated after the TPMS is set. The warning light will also illuminate to warn

the driver of system malfunction. Please refer to the above image (1) for further information.

TPMS Setting

The driver can set the TPMS by following procedures below:

1. Inflate all tyres to the recommended pressure.
2. Start the engine, make sure the vehicle is not moving, and press the TPMS switch (2) right side on the driver's seat for over 3 seconds.
3. Check if the (!) warning indicator blinks for 4 seconds.
4. Check if following message appears on the cluster (if equipped).

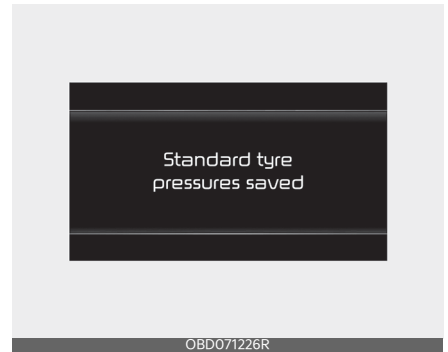

* If the warning light does not blink or the message does not pop up, perform the process again from 2).

For recommended tyre pressure of this vehicle, refer to "Tyres and wheels" on page 9-8 or the tyre pressure label on the driver's door.

For proper function of the TPMS, the driver must set the system in following situations.

* Situation requiring TPMS setting

- If the tyre or wheel is repaired or replaced

- If the tyre or wheel is repositioned.
- If the tyre pressure is adjusted.
- If the low pressure light is illuminated.
- If suspension or ABS has been replaced.

⚠ CAUTION

If the system is set without adjusting tyre pressure, false alarm could occur or the telltale will not be displayed even though the vehicle is significantly under-inflated. Make sure all tyres are properly adjusted to the recommended pressure when setting.

If the system is not set even in required situations, false alarm could occur or the telltale will not be displayed even though the vehicle is significantly under-inflated.

The system will not be set if you press the SET switch (2) whilst driving. Make sure to stop the vehicle and press the switch (2) for over 3 seconds.

- Be sure the tyre is cold before inflating the pressure.
A cold tyre means the vehicle has been sitting for 3 hours or driven within 1.6 km (1 mile).

Indication of Low Tyre Pressure

The (⚠) warning light will illuminate when an under-inflated tyre is indicated. In certain tyres, the below message might be displayed on the cluster.

If the warning light illuminates, reduce your speed, avoid hard cornering and rapid braking. Have your vehicle inspected by a professional workshop. Kia recommends to visit an authorised Kia dealer/service partner.



Check the pressure of all tyres and inflate to the proper pressure according to procedures, and if required, replace or repair the tyres.

If you cannot reach a close service station, stop the vehicle at a safe place, check all tyres and operate the TPMS setting procedure. If you are unable to adjust the tyre pressure, use the repair tools to repair or change to spare tyre and contact a professional workshop. Kia recommends to call an authorised Kia dealer/service partner.

You may not be able to identify low tyre pressure visually. Use precise tools to measure and adjust tyre pressure. Please note that a tyre that is hot due to prolonged driving, therefore will have high pressure. We recommend you to measure and adjust the tyre pressure after the vehicle has driven for less 1.6 km (1 mile) within 3 hours.

⚠ CAUTION

- The indicator may remain illuminated after changing to a spare tyre, because radius of spare tyre is different. Be sure to change to a regular tyre.
- For safe driving, please note that the TPMS is not a substitute for proper

tyre maintenance. It is the driver's responsibility to maintain correct tyre pressure, and all tyres should be checked monthly to maintain the recommended pressure.

- The warning light may illuminate if the system is not set in required situations.
- In cold weather, the low tyre pressure warning light may illuminate even if the tyre was adjusted to the proper pressure. It does not mean your TPMS is malfunctioning because the decreased temperature leads to a lowering of tyre pressure. Check the tyres and adjust to the recommended pressure.
- System performance may reduce in the following situations.
 - Improper system setting
 - Using tyres on the market (Original tyre recommended)
 - Driving on snowy, slippery, or unpaved roads
 - Hard cornering, rapid accelerating and braking repeatedly
 - Driving too slow or fast
 - If the vehicle is overloaded
 - If a spare tyre or snow chain is installed
- When filling tyres with more air, conditions to turn off the low tyre pressure telltale may not be met. This is because a tyre inflator has a margin of error in performance. The low tyre pressure telltale will be turned off if the tyre pressure is above the recommended tyre inflation pressure.

WARNING

- Driving with an under-inflated tyre causes the tyre to overheat and lead

to tyre failure. It also reduces tyre tread life, handling of the vehicle, braking ability, and fuel efficiency, causing instability of the vehicle. In this case, contact professional workshop to maintain proper tyre pressure. Kia recommends to contact an authorised Kia dealer/service partner.

- Sudden damage to the tyre caused by external factors may not be indicated immediately. If the vehicle is unstable, immediately remove your foot off the accelerator pedal, move the vehicle to a safe position for inspection.

Tyre Pressure Monitoring System malfunction

The TPMS malfunction indicator will illuminate () after it blinks for approximately 1 minute when there is a problem with the Tyre Pressure Monitoring System. This sequence will continue upon subsequent vehicle start-ups as long as the malfunction exists.

If the indicator remains illuminated or illuminates even after TPMS setting, have the system checked by a professional workshop. Kia recommends to visit an authorised Kia dealer/service partner.

WARNING

- If there is a malfunction with the TPMS, low tyre pressure will not be indicated. In this case, have the system serviced by a professional workshop. Kia recommends to visit an authorised Kia dealer/service partner.
- If the system does not work due to TPMS removal or installation of related parts with different specification, it might be a problem when the vehicle is being regularly inspected.

- When repairing TPMS related parts, be sure to replace them to parts with original specification or those which satisfy the TPMS regulation.
 - TPMS related parts : tyre, wheel, ABS unit, suspension

⚠ WARNING





FOR EUROPE

Do not modify the vehicle. It may interfere with the TPMS function.

* All vehicles sold in the EUROPE market during below period must be equipped with TPMS.

- New model vehicle : Nov. 1, 2012 ~
- Current model vehicle : Nov. 1, 2014~(Based on vehicle registrations)

Reference : Indicator Light Status

Status	Symbol
Low Pressure	 Illuminates
System Malfunction	  Illuminates after blinking (70 seconds)
Setting	  Turns off after blinking(4seconds)

If you have a flat tyre (with spare tyre) (if equipped)

Jack and tools

The jack, jack handle, wheel lug nut wrench, towing hook are stored in the luggage compartment.

4Door



5Door



Pull up the luggage box cover to reach this equipment.

- Jack handle
- Jack
- Wheel lug nut wrench
- Screw driver
- Spanner
- Towing hook

7. Rear towing hook (if equipped)

Jacking instructions

The jack is provided for emergency tyre changing only.

To prevent the jack from “rattling” whilst the vehicle is in motion, store it properly. Follow jacking instructions to reduce the possibility of personal injury.

⚠ WARNING

Changing tyres

- Never attempt vehicle repairs in the traffic lanes of a public road or highway.
- Always move the vehicle completely off the road and onto the shoulder before trying to change a tyre. The jack should be used on firm level ground. If you cannot find a firm level place off the road, call a towing service company for assistance.
- Be sure to use the correct front and rear jacking positions on the vehicle; never use the bumpers or any other part of the vehicle for jacking support.
- The vehicle can easily roll off the jack causing serious injury or death.
- Do not get under a vehicle that is supported by a jack.
- Do not start or run the engine whilst the vehicle is on the jack.
- Do not allow anyone remain in the vehicle whilst it is on the jack.
- Make sure any children present are in a secure place away from the road and from the vehicle to be raised with the jack.

Removing and storing the spare tyre

Turn the tyre hold-down wing bolt counter clockwise.

Store the tyre in the reverse order of removal.

To prevent the spare tyre and tools from “rattling” whilst the vehicle is in motion, store them properly.



⚠ WARNING

Ensure the spare tyre retainer is properly aligned with the centre of the spare tyre to prevent the spare tyre from “rattling”. Otherwise, it may cause the spare tyre to fall off the carrier and lead to an accident.

Changing tyres

1. Park on a level surface and apply the parking brake firmly.
2. Shift the shift lever into R (Reverse) with manual transmission or P (Park) with automatic transmission.
3. Activate the hazard warning flasher.



OBD061099L

4. Remove the wheel lug nut wrench, jack, jack handle, and spare tyre from the vehicle.
5. Block both the front and rear of wheel that is diagonally opposite the jack position.



OBD061100R

⚠ WARNING

Changing a tyre

- To prevent vehicle movement whilst changing a tyre, always set the parking brake fully, and always block the wheel diagonally opposite the wheel being changed.
- We recommend that the wheels of the vehicle be chocked, and that no person remain in a vehicle that is being jacked.

6. Loosen the wheel lug nuts counter-clockwise one turn each, but do not remove any nut until the tyre has been raised off the ground.



OBD061026L

7. Place the jack at the front (1) or rear (2) jacking position closest to the tyre you are changing. Place the jack at the designated locations under the frame. The jacking positions are plates welded to the frame with two tabs and a raised dot to index with the jack.

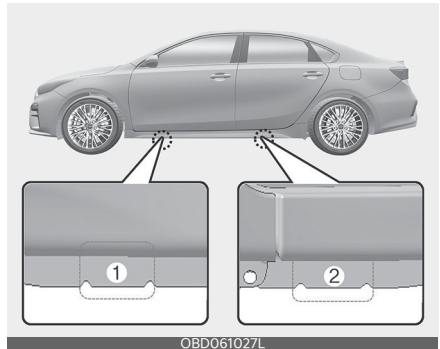

OBD061027L

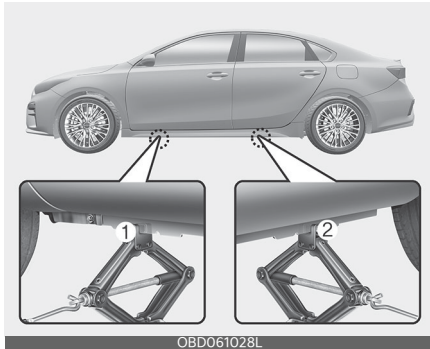

OBDO61028L

⚠ WARNING

Jack location

To reduce the possibility of injury, be sure to use only the jack provided with the vehicle and in the correct jack position; never use any other part of the vehicle for jack support.

- Insert the jack handle into the jack and turn it clockwise, raising the vehicle until the tyre just clears the ground. This measurement is approximately 30 mm (1.2 in). Before removing the wheel lug nuts, make sure the vehicle is stable and that there is no chance for movement or slippage. Refer to "Tyres and wheels" on page 9-8 or the tyre pressure label on the driver's door.

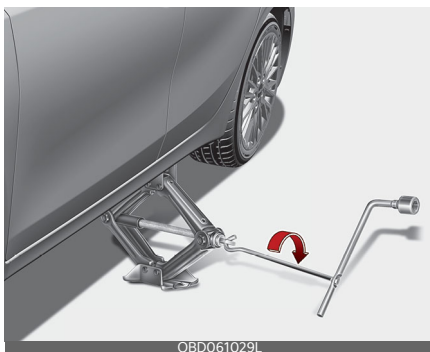

OBDO61029L

- Loosen the wheel nuts and remove them with your fingers. Slide the wheel off the studs and lay it flat so it cannot roll away. To put the wheel on the hub, pick up the spare tyre, line up the holes with the studs and slide the wheel onto them.

If this is difficult, tip the wheel slightly and get the top hole in the wheel lined up with the top stud. Then jiggle the wheel back and forth until the wheel can be slid over the other studs.

⚠ WARNING

Wheels may have sharp edges. Handle them carefully to avoid possible severe injury. Before putting the wheel into place, be sure that there is nothing on the hub or wheel (such as mud, tar, gravel, etc.) that interferes with the wheel from fitting solidly against the hub.

If there is, remove it. If there is not good contact on the mounting surface between the wheel and hub, the wheel nuts could come loose and cause the loss of a wheel. Loss of a wheel may result in loss of control of the vehicle. This may cause serious injury or death.

- To reinstall the wheel, hold it on the studs, put the wheel nuts on the studs and tighten them finger tight. Jiggle the tyre to be sure it is completely seated, then tighten the nuts as much as possible with your fingers again.
- Lower the vehicle to the ground by turning the wheel nut wrench counterclockwise.

Then position the wrench as shown in the drawing and tighten the wheel nuts. Be sure the socket is seated completely over the nut. Do not stand on the wrench handle or use an extension pipe over the

wrench handle. Go around the wheel tightening every other nut until they are all tight. Then double-check each nut for tightness. After changing wheels, have the system checked by a professional workshop. Kia recommends to visit an authorised Kia dealer/service partner.

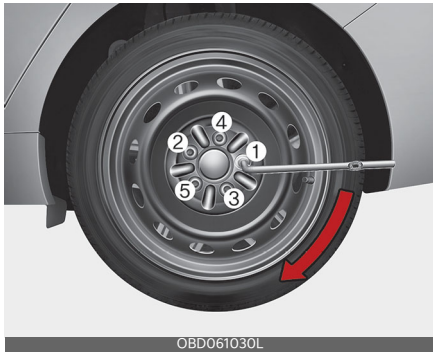

Wheel nut tightening torque:

Steel wheel & aluminum alloy wheel:
11~13 kgf-m (79~94 lbf-ft)

If you have a tyre gauge, remove the valve cap and check the air pressure. If the pressure is lower than recommended, drive slowly to the nearest service station and inflate to the correct pressure. If it is too high, adjust it until it is correct. Always reinstall the valve cap after checking or adjusting tyre pressure. If the cap is not replaced, air may leak from the tyre. If you lose a valve cap, buy another and install it as soon as possible.

After you have changed wheels, always secure the flat tyre in its place and return the jack and tools to their proper storage locations.

CAUTION

Your vehicle has metric threads on the wheel studs and nuts. Make certain during wheel removal that the same nuts that were removed are reinstalled -

or, if replaced, that nuts with metric threads and the same chamfer configuration are used. Installation of a non-metric thread nut on a metric stud or vice-versa will not secure the wheel to the hub properly and will damage the stud so that it must be replaced.

Note that most lug nuts do not have metric threads. Be sure to use extreme care in checking for thread style before installing aftermarket lug nuts or wheels.

If in doubt, consult a professional workshop. Kia recommends to consult an authorised Kia dealer/service partner.

WARNING

Wheel studs

If the studs are damaged, they may lose their ability to retain the wheel. This could lead to the loss of the wheel and a collision resulting in serious injuries.

To prevent the jack, jack handle, wheel lug nut wrench and spare tyre from rattling whilst the vehicle is in motion, store them properly.

WARNING

Inadequate spare tyre pressure

Check the inflation pressures as soon as possible after installing the spare tyre. Adjust it to the specified pressure, if necessary. Refer to "Tyres and wheels" on page 9-8.

Important - use of compact spare tyre (if equipped)

Your vehicle is equipped with a compact spare tyre. This compact spare tyre takes up less space than a regular-size tyre. This tyre is smaller than a conven-

tional tyre and is designed for temporary use only.

⚠ CAUTION

- You should drive carefully when the compact spare is in use. The compact spare should be replaced by the proper conventional tyre and rim at the first opportunity.
- The operation of this vehicle is not recommended with more than one compact spare tyre in use at the same time.

⚠ WARNING

The compact spare tyre is for emergency use only. Do not operate your vehicle on this compact spare at the speed over 80 km/h (50 mph). The original tyre should be repaired or replaced as soon as possible to avoid failure of the spare possibly leading to personal injury or death.

The compact spare should be inflated to 420 kPa (60 psi).

*** NOTICE**

Check the inflation pressure after installing the spare tyre. Adjust it to the specified pressure, as necessary.

When using a compact spare tyre, observe the following precautions:

- Under no circumstances should you exceed 80 km/h (50 mph); a higher speed could damage the tyre.
- Ensure that you drive slowly enough to avoid all hazards. Any road hazard, such as a pothole or debris, could seriously damage the compact spare.
- Any continuous road use of this tyre could result in tyre failure, loss of

vehicle control, and possible personal injury.

- Do not exceed the vehicle's maximum load rating or the load-carrying capacity shown on the sidewall of the compact spare tyre.
- Avoid driving over obstacles. The compact spare tyre diameter is smaller than the diameter of a conventional tyre and reduces the ground clearance approximately 2.5 cm (1 inch), which could result in damage to the vehicle.
- Do not take the vehicle through an automatic car wash whilst the compact spare tyre is installed.
- Do not use tyre chains on the temporary compact tyre. Because of the smaller size, a tyre chain will not fit properly. This could damage the vehicle and result in loss of the chain.
- Temporary compact tyre should not be installed on the front axle if the vehicle must be driven in snow or on ice.
- Do not use the temporary compact tyre on any other vehicle because this tyre has been designed especially for your vehicle.
- The temporary compact tyre tread life is shorter than a regular tyre. Inspect your temporary compact tyre regularly and replace worn compact spare tyres with the same size and design, mounted on the same wheel.
- The temporary compact tyre should not be used on any other wheels, nor should standard tyres, snow tyres, wheel covers or trim rings be used with the temporary compact spare wheel. If such use is attempted, damage to these items or other car components may occur.

- Do not use more than one temporary compact tyre at a time.
- Do not tow a trailer whilst the temporary compact tyre is installed.

Jack label

Example

Type A

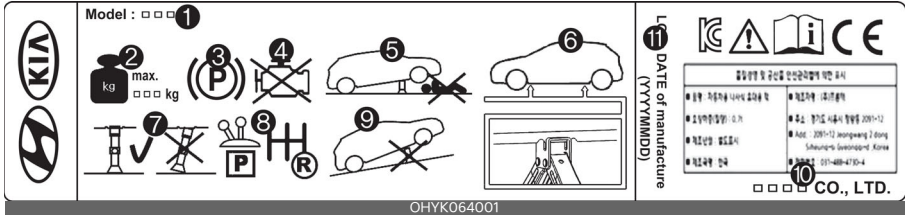

Type B

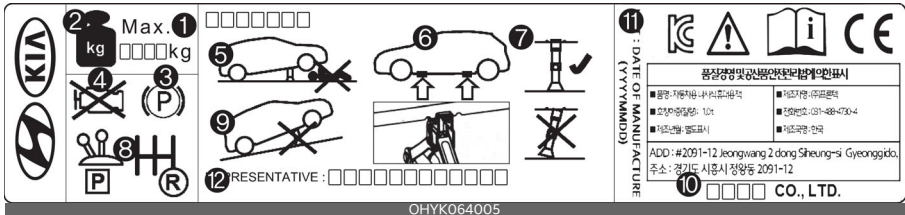

* The actual Jack label in the vehicle may differ from the illustration. For more detailed specifications, refer to the label attached to the jack.

1. Model Name
2. Maximum allowable load
3. When using the jack, set your parking brake.
4. When using the jack, stop the engine.
5. Do not get under a vehicle that is supported by a jack.
6. The designated locations under the frame
7. When supporting the vehicle, the base plate of jack must be vertical under the lifting point.
8. Shift into Reverse gear on vehicles with manual transmission or move the shift lever to the P position on vehicles with automatic transmission.
9. The jack should be used on firm level ground.
10. Jack manufacturer
11. Production date
12. Representative company and address

EC Declaration of Conformity for Jack



EC Declaration of Conformity according to EC Machinery Directive 2006/42/EC

We, **SAMKI IND. CO., LTD.**
22, Hyojuk3-Gil, Buk-Gu, Ulsan, Korea
declare under our sole responsibility that the product

Product : Jack Assembly
Type Designation(s) : Jack Assembly-600kg, Jack Assembly-700kg
Jack Assembly-800kg, Jack Assembly-1000kg
Jack Assembly-1200kg, Jack Assembly-1500kg
Serial No. : N/A
Year of Manufacture : 2013

to which this declaration relates is in conformity with the following standard(s) or other normative document(s);

- EN ISO12100 (2010) Safety of machinery - General principles for design – Risk assessment and risk reduction
- EN ISO12100-2/A1 (2009) Safety of machinery - Basic concepts, general principles for design, Part 2 : Technical principles
- EN 1494/A1 (2008) Mobile or movable jacks and associated lifting equipment

following the provisions of Directive(s);

- 2006/42/EC Directive on the approximation of the laws of Member States relating to machinery (OJ L157 Jun, 9, 2006)

Ulsan , Korea / Jul .25 .2013 Hyun Duck, Cho President 
(Place and date of issue)(name and signature or equivalent making of authorized person)

* T.C.F Compiling Person: Safenet Limited (European Notified body : 1674)
Denford Garage, Denford, Kettering Northants, NN14 4EQ, England

7

Towing

Towing service

If emergency towing is necessary, we recommend having it done by an authorised Kia dealer or a commercial tow-truck service. Proper lifting and towing procedures are necessary to prevent damage to the vehicle. The use of wheel dollies (1) or flatbed is recommended. It is acceptable to tow the vehicle with the rear wheels on the ground (without dollies) and the front wheels off the ground.

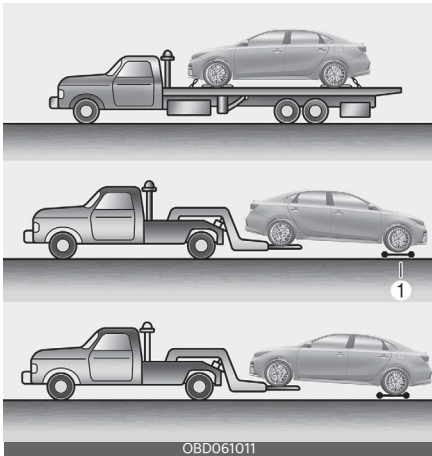

If any of the loaded wheels or suspension components are damaged or the vehicle is being towed with the front wheels on the ground, use a towing dolly under the front wheels.

When being towed by a commercial tow truck and wheel dollies are not used, the front of the vehicle should always be lifted, not the rear.

⚠ CAUTION

- Do not tow the vehicle backwards with the front wheels on the ground

as this may cause damage to the vehicle.

- Do not tow with sling-type equipment. Use wheel lift or flatbed equipment.



When towing your vehicle in an emergency without wheel dollies:

1. Set the ignition switch in the ACC position.
2. Place the transmission shift lever in N (Neutral).
3. Release the parking brake.

⚠ CAUTION

Failure to place the transmission shift lever in N (Neutral) may cause internal damage to the transmission.

Removable towing hook (if equipped)

1. Open the trunk/tailgate, and remove the towing hook from the tool case.

4Door

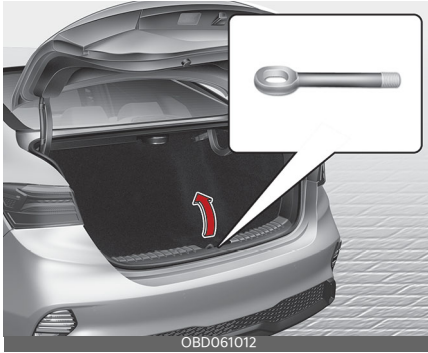

Front

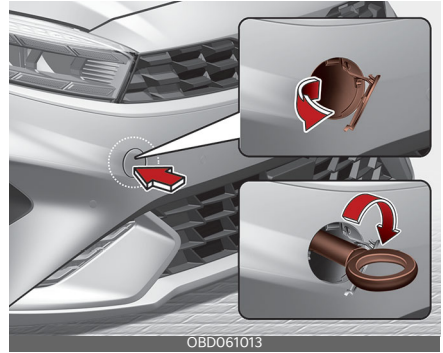

5Door

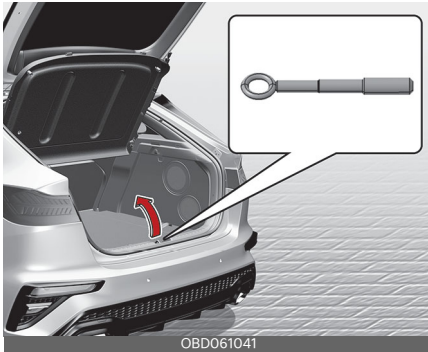

Rear(5Door)

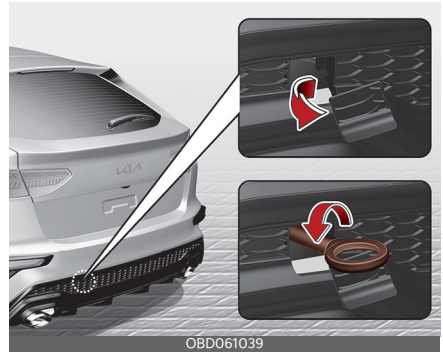

2. Remove the hole cover pressing the upper (front) part of the cover on the bumper.
3. Install the towing hook by turning it clockwise into the hole until it is fully secured.
4. Remove the towing hook and install the cover after use.

Emergency towing

Front

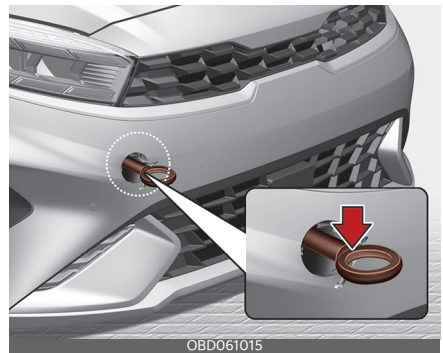

Rear(4Door)

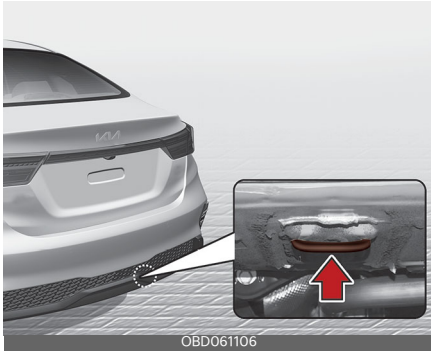

Rear(5Door)



If towing is necessary, we recommend you to have it done by an authorised Kia dealer or a commercial tow truck service.

If towing service is not available in an emergency, your vehicle may be temporarily towed using a cable or chain secured to the emergency towing hook under the front (or rear) of the vehicle. Use extreme caution when towing the vehicle. A driver must be in the vehicle to steer it and operate the brakes.

Towing in this manner may be done only on hard-surfaced roads for a short distance and at low speed. Also, the wheels, axles, power train, steering and brakes must all be in good condition.

- Do not use the tow hooks to pull a vehicle out of mud, sand or other conditions from which the vehicle cannot be driven out under its own power.
- Avoid towing a vehicle heavier than the vehicle doing the towing.
- The drivers of both vehicles should communicate with each other frequently.

⚠ CAUTION

- Attach a towing strap to the tow hook.
- Using a portion of the vehicle other than the tow hooks for towing may damage the body of your vehicle.
- Use only a cable or chain specifically intended for use in towing vehicles. Securely fasten the cable or chain to the towing hook provided.
- Accelerate or decelerate the vehicle in a slow and gradual manner whilst maintaining tension on the tow rope or chain to start or drive the vehicle, otherwise tow hooks and the vehicle may be damaged.

- Before emergency towing, check if the hook is not broken or damaged.
- Fasten the towing cable or chain securely to the hook.
- Do not jerk the hook. Apply it steadily and with even force.
- To avoid damaging the hook, do not pull from the side or at a vertical angle. Always pull straight ahead.

⚠ WARNING

Use extreme caution when towing the vehicle.

- Avoid sudden starts or erratic driving manoeuvres which would place excessive stress on the emergency towing hook and towing cable or

chain. The hook and towing cable or chain may break and cause serious injury or damage.

- If the disabled vehicle is unable to be moved, do not forcibly continue the towing. We recommend that you contact an authorised Kia dealer or a commercial tow truck service for assistance.
- Tow the vehicle as straight ahead as possible.
- Keep away from the vehicle during towing.

-
- Use a towing strap less than 5 m (16 feet) long. Attach a white or red cloth (about 30 cm (12 inches) wide) in the middle of the strap for easy visibility.
 - Drive carefully so that the towing strap is not loosened during towing.
 - The driver must be in the vehicle for steering and braking operations when the vehicle is towed and passengers other than the driver must not be allowed to be on board.

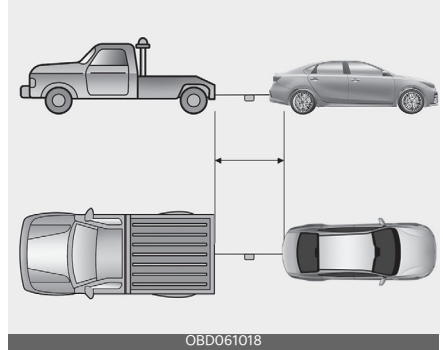
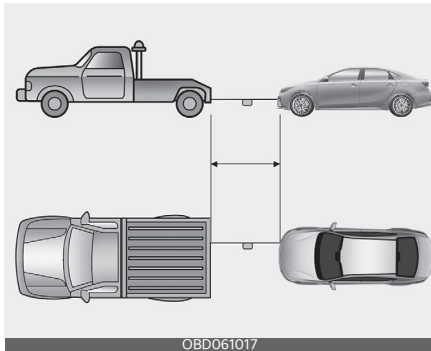

Emergency towing precautions

- Turn the ignition switch to ACC so the steering wheel isn't locked.
- Place the transmission shift lever in N (Neutral).
- Release the parking brake.
- Press the brake pedal with more force than normal since you will have reduced brake performance.
- More steering effort will be required because the power steering system will be disabled.
- If you are driving down a long hill, the brakes may overheat and brake performance will be reduced. Stop often and let the brakes cool off.
- The vehicle should be towed at a speed of 25 km/h (15 mph) or less within the distance of 20 km (12 miles). (For Manual transmission vehicle)
- To avoid serious damage to the automatic transmission and dual clutch transmission, limit the vehicle speed to 15 km/h (10 mph) and drive less than 1.5 km (1 mile) when towing. (for Automatic transmission and Dual Clutch Transmission vehicle)

⚠ CAUTION**Automatic transmission/Dual Clutch Transmission**

- If the car is being towed with all four wheels on the ground, it can be towed only from the front. Be sure that the transmission is in neutral. Be sure the steering is unlocked by placing the ignition switch in the ACC position. A driver must be in the towed vehicle to operate the steering and brakes.
 - Before towing, check the Automatic transmission/Dual Clutch Transmission for fluid leaks under your vehicle. If the Automatic transmission/Dual Clutch Transmission fluid is leaking, flatbed equipment or a towing dolly must be used.
-

Emergency Commodity (if equipped)

There are some emergency commodities in the vehicle to help you respond to the emergency situation.

Fire extinguisher

If there is small fire and you know how to use the fire extinguisher, take the following steps carefully.

1. Pull the pin at the top of the extinguisher that keeps the handle from being accidentally pressed.
2. Aim the nozzle toward the base of the fire.
3. Stand approximately 2.5 m (8 ft) away from the fire and squeeze the handle to discharge the extinguisher. If you release the handle, the discharge will stop.
4. Sweep the nozzle back and forth at the base of the fire. After the fire appears to be out, watch it carefully since it may re-ignite.

First aid kit

There are some items such as scissors, bandage and adhesive tape and etc. in the kit to give first aid to an injured person.

Triangle reflector

Place the triangle reflector on the road to warn oncoming vehicles during emergencies, such as when the vehicle is parked by the roadside due to any problems.

Tyre pressure gauge (if equipped)

Tyres normally lose some air in day-to-day use, and you may have to add a few pounds of air periodically and it is not usually a sign of a leaking tyre, but of normal wear. Always check tyre pressure when the tyres are cold because tyre pressure increases with temperature.

To check the tyre pressure, take the following steps;

1. Unscrew the inflation valve cap that is located on the rim of the tyre.
2. Press and hold the gauge against the tyre valve. Some air will escape as you begin and more will escape if you don't press the gauge in firmly.
3. A firm non-leaking push will activate the gauge.
4. Read the tyre pressure on the gauge to know whether the tyre pressure is low or high.
5. Adjust the tyre pressures to the specified pressure. Refer to "Tyres and wheels" on page 9-8.
6. Reinstall the inflation valve cap.

Engine compartment	8-5
Maintenance services	8-7
• Owner's responsibility.....	8-7
• Owner maintenance precautions.....	8-7
Owner maintenance	8-8
• Owner maintenance schedule.....	8-8
Scheduled maintenance service	8-10
• Scheduled maintenance service precaution.....	8-10
Explanation of scheduled maintenance items	8-35
• Engine oil and filter.....	8-35
• Drive belts.....	8-35
• Fuel filter cartridge (for diesel engine).....	8-35
• Fuel filter (for petrol engine).....	8-35
• Fuel lines, fuel hoses and connections.....	8-36
• Vapour hose and fuel filler cap (for petrol engine).....	8-36
• Vacuum crankcase ventilation hoses.....	8-36
• Air cleaner filter.....	8-36
• Spark plugs (for petrol engine).....	8-36
• Cooling system.....	8-37
• Coolant.....	8-37
• Dual clutch transmission fluid.....	8-37
• Automatic transmission fluid.....	8-37
• Brake hoses and lines.....	8-37
• Brake fluid.....	8-37
• Parking brake.....	8-37
• Brake discs, pads and calipers.....	8-37
• Suspension mounting bolts.....	8-37
• Steering gear box, linkage & boots/lower arm ball joint.....	8-38
• Drive shafts and boots.....	8-38
• Air conditioning refrigerant.....	8-38
• Propeller shaft.....	8-38

8 Maintenance

• Checking fluid levels.....	8-38
Engine oil (Petrol)	8-38
• Checking the engine oil level.....	8-38
• Changing the engine oil and filter.....	8-40
Engine Coolant	8-41
• Checking the coolant level.....	8-41
• Changing the coolant.....	8-44
Brake/clutch fluid	8-45
• Checking the brake/clutch fluid level.....	8-45
Washer fluid	8-46
• Checking the washer fluid level	8-46
Parking brake (Hand type).....	8-47
• Checking the parking brake.....	8-47
Air cleaner.....	8-47
• Filter replacement.....	8-47
Climate control air filter.....	8-49
• Filter inspection	8-49
Wiper blades.....	8-50
• Blade inspection.....	8-50
• Blade replacement	8-50
Battery.....	8-52
• For best battery service	8-52
• Battery capacity label	8-53
• Battery recharging	8-54
• Reset items	8-55
Tyres and wheels	8-55
• Tyre care.....	8-55
• Recommended cold tyre inflation pressures.....	8-55
• Checking tyre inflation pressure.....	8-56
• Tyre rotation.....	8-57

• Wheel alignment and tyre balance	8-58
• Tyre replacement	8-58
• Wheel replacement	8-59
• Tyre traction	8-59
• Tyre maintenance	8-59
• Tyre sidewall labeling	8-60
• Low aspect ratio tyre	8-62
Fuses	8-63
• Inner panel fuse replacement	8-65
• Engine compartment fuse replacement	8-66
• Fuse/relay panel description	8-68
Light bulbs	8-79
• Bulb replacement precaution	8-79
• Light bulb position (Front)	8-80
• Light bulb position (Rear)	8-81
• Light bulb position (Side)	8-83
• Headlamp (High/Low) (Bulb type) bulb replacement - Headlamp Type A	8-84
• Front turn signal lamp (Bulb type) bulb replacement - Headlamp Type A	8-85
• Position lamp/Daytime running lamp (LED type) bulb replacement - Headlamp Type A	8-85
• Headlamp (LED type) bulb replacement - Headlamp Type B ..	8-86
• Front fog lamp (LED type) bulb replacement	8-86
• Side repeater lamp (LED type) bulb Replacement	8-86
• Side repeater lamp (Bulb type) bulb Replacement	8-87
• Stop/Tail lamp (Bulb type) bulb replacement - 4 door type A, B ..	8-87
• Stop/Tail lamp (Bulb type) bulb replacement - 5 door type A ..	8-88
• Tail lamp (Inside) (Bulb type) bulb replacement - 4door Type A, B ..	8-89

8 Maintenance

- Tail lamp (Inside) (Bulb type) bulb replacement - 5 door type A..8-89
- Rear fog lamp (Bulb type) bulb replacement - 4door Type B..8-90
- Rear fog lamp (Bulb type) bulb replacement -5door 8-91
- Stop and tail lamp (LED type) bulb replacement 8-91
- Rear fog lamp (LED type) bulb replacement - 4door Type D....8-92
- Rear turn signal lamp (Bulb type) bulb replacement8-92
- Back up lamp (Bulb type) bulb replacement.....8-93
- License plate lamp (Bulb type) bulb replacement8-93
- High mounted stop lamp (bulb type) bulb replacement 8-94
- High mounted stop lamp bulb replacement8-94
- Map lamp (Bulb type) bulb replacement8-95
- Map lamp (LED type) bulb replacement8-95
- Room lamp (Bulb type) bulb replacement8-95
- Room lamp (LED type) bulb replacement8-96
- Vanity mirror lamp (Bulb type) bulb replacement8-96
- Trunk/tailgate room lamp (Bulb type) bulb replacement.....8-97
- Glove box lamp (Bulb type) replacement8-97
- Headlamp and front fog lamp aiming (for Europe) 8-98
- Appearance care..... 8-103**
 - Exterior care 8-103
 - Interior care 8-107
- Emission control system 8-109**
 - 1. Crankcase emission control system..... 8-109
 - 2. Evaporative emission control system..... 8-109
 - 3. Exhaust emission control system 8-109

Maintenance

Engine compartment

(Petrol) 1.6 MPI

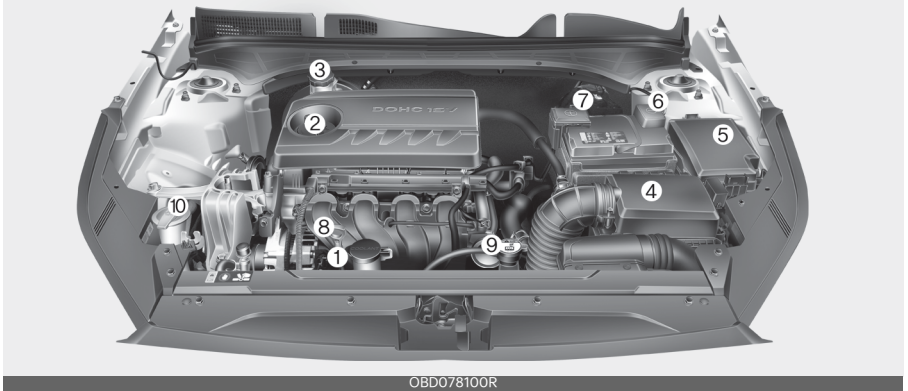

OBD078100R

(Petrol) 2.0 MPI

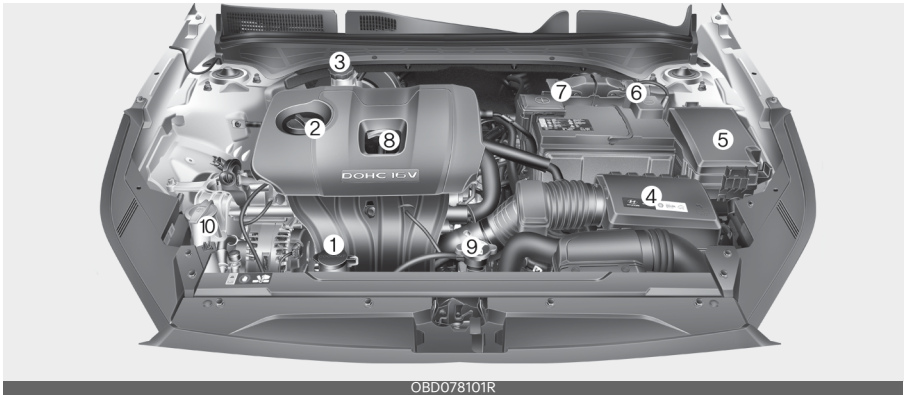

OBD078101R

* The actual engine room in the vehicle may differ from the illustration.

- | | |
|---------------------------------------|------------------------------|
| 1. Engine coolant reservoir | 6. Negative battery terminal |
| 2. Engine oil filler cap | 7. Positive battery terminal |
| 3. Brake / clutch fluid reservoir | 8. Engine oil dipstick |
| 4. Air cleaner | 9. Radiator cap |
| 5. Fuse box | |
| 10. Windscreen washer fluid reservoir | |

(Petrol) 1.6 T-GDi

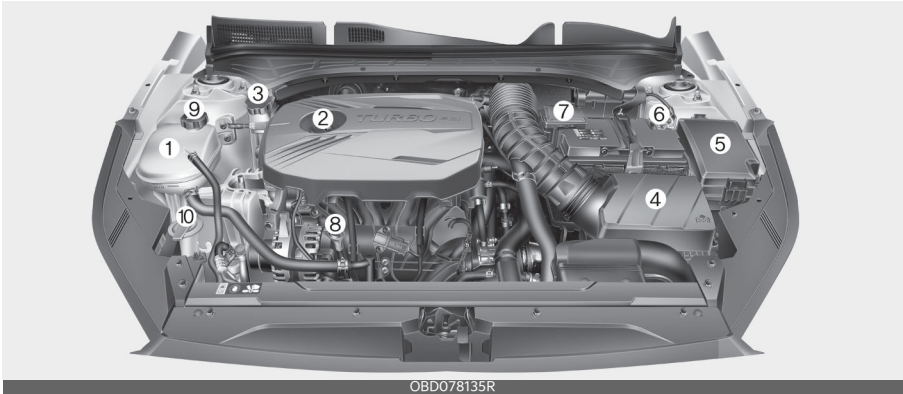

OBD078135R

Smartstream G1.6

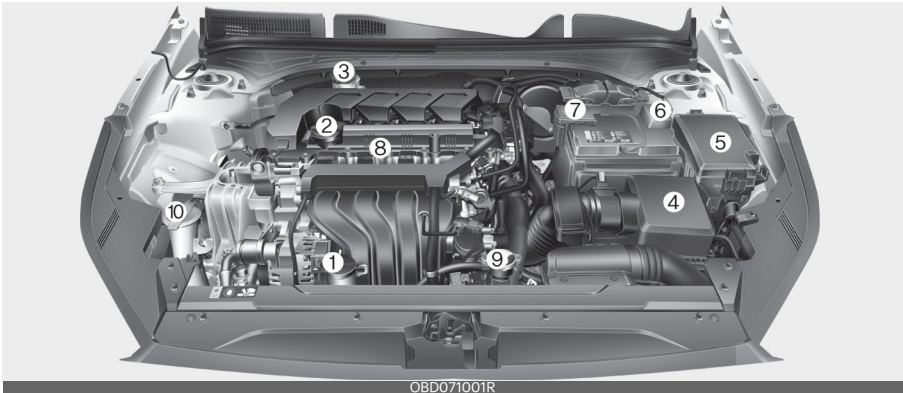

OBD071001R

* The actual engine room in the vehicle may differ from the illustration.

- | | |
|---------------------------------------|------------------------------|
| 1. Engine coolant reservoir | 6. Negative battery terminal |
| 2. Engine oil filler cap | 7. Positive battery terminal |
| 3. Brake / clutch fluid reservoir | 8. Engine oil dipstick |
| 4. Air cleaner | 9. Radiator cap |
| 5. Fuse box | |
| 10. Windscreen washer fluid reservoir | |

Maintenance services

You should exercise the utmost care to prevent damage to your vehicle and injury to yourself whenever performing any maintenance or inspection procedures.

Inadequate, incomplete or insufficient servicing may result in operational problems with your vehicle that could lead to vehicle damage, an accident, or personal injury.

Owner's responsibility

* NOTICE

Maintenance Service and Record Retention are the owner's responsibility.

Have your vehicle serviced by a professional workshop. Kia recommends to visit an authorised Kia dealer/service partner.

You should retain documents that show proper maintenance has been performed on your vehicle in accordance with the scheduled maintenance service charts shown on the following pages.

You need this information to establish your compliance with the servicing and maintenance requirements of your vehicle warranties.

Detailed warranty information is provided in your Warranty & Maintenance book.

Repairs and adjustments required as a result of improper maintenance or a lack of required maintenance are not covered when your vehicle is covered by warranty.

Owner maintenance precautions

Improper or incomplete service may result in problems. This section gives

instructions only for the maintenance items that are easy to perform.

* NOTICE

Improper owner maintenance during the warranty period may affect warranty coverage. For details, read the separate Warranty & Maintenance book provided with the vehicle. If you're unsure about any servicing or maintenance procedure, have the system serviced by a professional workshop. Kia recommends to visit an authorised Kia dealer/service partner.

⚠ WARNING

Maintenance work

- Performing maintenance work on a vehicle can be dangerous. You can be seriously injured whilst performing some maintenance procedures. If you lack sufficient knowledge and experience or the proper tools and equipment to do the work, have the system serviced by a professional workshop. Kia recommends to visit an authorised Kia dealer/service partner.
- Working under the bonnet with the engine running is dangerous. It becomes even more dangerous when you wear jewelry or loose clothing. These can become entangled in moving parts and result in injury. Therefore, if you must run the engine whilst working under the bonnet, make certain that you remove all jewelry (especially rings, bracelets, watches, and necklaces) and all neckties, scarves, and similar loose clothing before getting near the engine or cooling fans.

⚠ CAUTION

- Do not put heavy objects or apply excessive force on top of the engine cover (if equipped) or fuel related parts.
- When you inspect the fuel system (fuel lines and fuel injection devices), contact a professional workshop. Kia recommends to visit an authorised Kia dealer/service partner.
- Do not drive long time with the engine cover removed.
- When checking the engine room, do not go near fire. Fuel, washer fluid, etc. are flammable oils that may cause fire.
- Before touching the battery, ignition cables and electrical wiring, you should disconnect the battery "-" terminal. You may get an electric shock from the electric current.
- When you remove the interior trim cover with a flat bed (-) driver, be careful not to damage the cover.
- Be careful when you replace and clean bulbs to avoid burns or electrical shock.

Owner maintenance

The following lists are vehicle checks and inspections that should be performed at the frequencies indicated to help ensure safe, dependable operation of your vehicle.

Any adverse conditions should be brought to the attention of your dealer as soon as possible.

These Owner Maintenance Checks are generally not covered by warranties and you may be charged for labour, parts and lubricants used.

Owner maintenance schedule

When you stop for fuel:

- Check the coolant level in the coolant reservoir.
- Check the windscreen washer fluid level.
- Look for low or under-inflated tyres.

⚠ WARNING

Be careful when checking your engine coolant level when the engine is hot. Scalding hot coolant and steam may blow out under pressure. This could cause burns or other serious injury.

Whilst operating your vehicle:

- Note any changes in the sound of the exhaust or any smell of exhaust fumes in the vehicle.
- Check for vibrations in the steering wheel. Notice any increased steering effort or looseness in the steering wheel, or change in its straight ahead position.
- Notice if your vehicle constantly turns slightly or "pulls" to one side when travelling on smooth, level road.

- When stopping, listen and check for unusual sounds, pulling to one side, increased brake pedal travel or "hard-to-push" brake pedal.
- If any slipping or changes in the operation of your transmission occurs, check the transmission fluid level.
- Check the parking brake.
- Check for fluid leaks under your vehicle (water dripping from the air conditioning system during or after use is normal).
- Lubricate the door hinges and checks, and bonnet hinges.
- Lubricate the door and bonnet locks and latches.
- Lubricate the door rubber weatherstrips.
- Check the air conditioning system.
- Inspect and lubricate the automatic transmission linkage and controls.
- Clean the battery and terminals.
- Check the brake fluid level.

At least monthly:

- Check the coolant level in the engine coolant reservoir.
- Check the operation of all exterior lights, including the stoplights, turn signals and hazard warning flashers.
- Check the inflation pressures of all tyres including the spare for tyres that are worn, show uneven wear, or are damaged.
- Check for loose wheel lug nuts.

At least twice a year (i.e., every Spring and Fall):

- Check the radiator, heater and air conditioning hoses for leaks or damage.
- Check the windscreen washer spray and wiper operation. Clean the wiper blades with clean cloth dampened with washer fluid.
- Check the headlight alignment.
- Check the muffler, exhaust pipes, shields and clamps.
- Check the lap/shoulder belts for wear and function.

At least once a year:

- Clean the body and door drain holes.

Scheduled maintenance service

schedule instead of the normal usage maintenance schedule.

Scheduled maintenance service precaution

Follow the Normal Maintenance Schedule if the vehicle is usually operated where none of the following conditions apply. If any of the following conditions apply, follow the Maintenance Under Severe Usage Conditions.

- Repeated driving short distance of less than 8 km (5 miles) in normal temperature or less than 16 km (10 miles) in freezing temperature
- Extensive engine idling or low speed driving for long distances
- Driving on rough, dusty, muddy, unpaved, graveled or salt-spread roads
- Driving in areas using salt or other corrosive materials or in very cold weather
- Driving in heavy dust condition
- Driving in heavy traffic area
- Driving on uphill, downhill, or mountain road repeatedly
- Using for towing or camping, and driving with loading on the roof
- Driving as a patrol car, taxi, other commercial use of vehicle towing
- Frequently driving under high speed or rapid acceleration/deceleration.
- Frequently driving in stop-and-go condition
- Engine oil usage which is not recommended (Mineral type, Semisynthetic, Lower grade spec, etc.)

If your vehicle is operated in any of the prior listed conditions, you should inspect, replace or refill more frequently, using the severe usage maintenance

Normal Maintenance Schedule - For Australia and New Zealand

The following maintenance services must be performed to ensure good emission control and performance. Keep receipts for all vehicle emission services to protect your warranty. Where both mileage and time are shown, the frequency of service is determined by whichever occurs first.

NO.	ITEM	REMARK
* 1	Fuel additives (Petrol)	Kia recommends that you use unleaded petrol which has an octane rating of RON (Research Octane Number) 95 / AKI (Anti Knock Index) 91 or higher (for Europe) or Octane Rating of RON (Research Octane Number) 91 / AKI (Anti-Knock Index) 87 or higher (except Europe). For customers who do not use good quality petrols including fuel additives regularly, and have problems starting or the engine does not run smoothly, one bottle of additives added to the fuel tank when the engine oil is replaced. Additives are available from a professional workshop along with information on how to use them. Kia recommends to visit an authorised Kia dealer/ service partner. Do not mix other additives.
* 2	Engine oil and engine oil filter	As it is normal for engine oil to be consumed during driving, the engine oil level should be checked on regular basis. The engine oil change interval for normal operating conditions is based on the use of the recommended engine specification. If the recommended engine oil specification is not used, then replace the engine oil according to the maintenance schedule under severe operating conditions.
* 3	Coolant (Engine)	When adding coolant, use only deionized water or soft water for your vehicle and never mix hard water in the coolant filled at the factory. An improper coolant mixture can result in serious malfunction or engine damage.
* 4	Spark plug	For your convenience, it can be replaced prior to its interval when you do maintenance of other items.
* 5	Drive belts (Engine)	<ul style="list-style-type: none"> Adjust alternator, water pump and air conditioner drive belt. Inspect and if necessary repair or replace. Inspect drive belt tensioner, idler and alternator pulley and if necessary correct or replace.
* 6	Manual transmission fluid / Dual clutch transmission (DCT) fluid	Manual transmission fluid (or Dual clutch transmission (DCT) fluid) should be changed anytime it has been submerged in water.

NO.	ITEM	REMARK
* 7	Valve clearance	Inspect for excessive valve noise and/or engine vibration and adjust if necessary. In this case, have the system checked by a professional workshop. Kia recommends to visit an authorised Kia dealer/service partner.

I: Inspect and if necessary, adjust, correct, clean or replace.

R: Replace or change.

Normal Maintenance Schedule - Non Turbo Model [For Australia and New Zealand]

I: Inspect and if necessary, adjust, correct, clean or replace.

R: Replace or change.

Number of months or driving distance, whichever comes first									
Months		12	24	36	48	60	72	84	96
Km×1,000		15	30	45	60	75	90	105	120
Engine oil and engine oil filter *2	(Petrol engine) 2.0 MPI	R	R	R	R	R	R	R	R
Climate control air filter		I	R	I	R	I	R	I	R
Coolant (Engine) *3		At first, Replace 210,000 km or 120 months after that, Replace every 30,000 km or 24 months							
Spark plugs *4	(Petrol) 2.0 MPI	Replace every 150,000 km							
	Unleaded Leaded	Replace every 75,000 km							
Air cleaner filter (Petrol)		I	I	R	I	I	R	I	I
Brake/clutch fluid		I	R	I	R	I	R	I	R
Air conditioner refrigerant									
Suspension ball joints									
Steering gear rack, linkage and boots		I	I	I	I	I	I	I	I
Air conditioner compressor									
Tyre (pressure & tread wear)									
Battery (12V) condition		-	I	-	I	-	I	-	I
Parking brake (Hand type) (if equipped)									
Brake lines, hoses and connections									
Brake discs and pads									
Exhaust system		-	I	-	I	-	I	-	I
Vacuum hoses and crankcase ventilation hoses (Petrol)									
Drive shaft and boots									
Fuel tank air filter (Petrol)		-	I	-	R	-	I	-	R
Drive belts (Engine)*5		-	-	I	I	I	I	I	I
Cooling system		-	-	-	I	-	I	-	I
Fuel lines, hoses and connections (Petrol)		-	-	-	I	-	-	-	I
Vapour hose and fuel filler cap (Petrol)		-	-	-	I	-	-	-	I

Number of months or driving distance, whichever comes first								
Months	12	24	36	48	60	72	84	96
Km×1,000	15	30	45	60	75	90	105	120
Manual transmission fluid *6 (if equipped)	No service required							
Automatic transmission fluid (if equipped)	No service required							

- Fuel filter (Petrol engine): The fuel filter is considered to be maintenance free but periodic inspection is recommended for this maintenance schedule depends on fuel quality.
 - If there are some important safety matters like fuel flow restriction, surging, loss of power, hard starting problem etc, replace the fuel filter immediately regardless of maintenance schedule and consult an authorised Kia dealer/service partner for details.

Normal Maintenance Schedule - Non Turbo Model [For Australia and New Zealand]

I: Inspect and if necessary, adjust, correct, clean or replace.

R: Replace or change.

MAINTENANCE ITEM		MAINTENANCE OPERATION	MAINTENANCE INTERVALS	DRIVING CONDITION
Engine oil and engine oil filter	(Petrol) 2.0 MPI	R	Every 7,500km or 6 months	A, B, C, D, E, F, G, H, I, J, K, L
Automatic transmission fluid		R	Every 90,000 km	A, C, F, G, H, I, J, K
Manual transmission fluid		R	Every 120,000 km	C, D, F, G, H, I, J
Climate control air filter		R	More frequently	C, E, G
Air cleaner filter		R	More frequently	C, E
Spark plugs		R	More frequently	A, B, F, G, H, I, K
Parking brake (Hand type) (if equipped)		I	More frequently	C, D, G, H
Brake discs, pads and calipers		I	More frequently	C, D, E, G, H, I, J, K
Suspension ball joints		I	More frequently	C, D, E, G, H, I
Steering gear rack, linkage and boots		I	More frequently	C, D, E, F, G
Drive shaft and boots		I	More frequently	C, D, E, F, G, H, I, J

Severe driving conditions

- A: Repeatedly driving short distance of less than 8 km in normal temperature or less than 16 km in freezing temperature.
- B: Extensive engine idling or low speed driving for long distances.
- C: Driving on rough, dusty, muddy, unpaved, graveled or saltspread roads.
- D: Driving in areas using salt or other corrosive materials or in very cold weather
- E: Driving in heavy dust condition.
- F: Driving in heavy traffic area.
- G: Driving on uphill, downhill, or mountain roads repeatedly.
- H: Using for towing or camping, and driving with loading on the roof.
- I: Driving for patrol car, taxi, other commercial use of vehicle towing.
- J: Frequently driving under high speed or rapid acceleration/deceleration.
- K: Frequently driving in stop-and-go conditions.
- L: Engine oil usage which is not recommended (Mineral type, Semisynthetic, Lower grade spec, etc.)

Normal Maintenance Schedule - Turbo Model [For Australia and New Zealand]

I: Inspect and if necessary, adjust, correct, clean or replace.

R: Replace or change.

Number of months or driving distance, whichever comes first		12	24	36	48	60	72	84	96
Months		10	20	30	40	50	60	70	80
Km X 1,000									
Fuel additives ^{*1}		Add every 10,000km or 12months							
Engine oil and engine oil filter ^{*2}	(Petrol) 1.6 T-GDi	R	R	R	R	R	R	R	R
Coolant (Engine) ^{*3}		At first, Replace 210,000 km or 120 months after that, Replace every 30,000 km or 24 months							
Spark plugs ^{*4}	(Petrol) 1.6 T-GDi	Replace every 70,000 km							
Drive belts (Engine) ^{*5}		-	I	-	I	-	I	-	I
Dual clutch transmission (DCT) fluid ^{*6}		No service required							
Valve clearance ^{*7}	(Petrol) 1.6 T-GDi	-	-	-	-	-	I	-	-
Vacuum hoses and crankcase ventilation hoses		-	I	-	I	-	I	-	I
Drive shaft and boots		-	I	-	I	-	I	-	I
Fuel lines, hoses and connections		-	-	-	-	-	I	-	I
Fuel tank air filter		-	-	I	-	-	R	-	-
Vapour hose and fuel filler cap		-	-	I	-	-	I	-	-
Air cleaner filter		I	I	R	I	I	R	I	I
Intercooler, in/out hose, air intake hose	(Petrol) 1.6 T-GDi	I	I	I	I	I	I	I	I
Exhaust system		-	I	-	I	-	I	-	I
Cooling system		-	-	-	I	-	I	-	I
Air conditioner compressor/refrigerant		I	I	I	I	I	I	I	I
Climate control air filter		I	R	I	R	I	R	I	R
Brake discs and pads		-	I	-	I	-	I	-	I
Brake lines, hoses and connections		-	I	-	I	-	I	-	I
Brake fluid		I	R	I	R	I	R	I	R
Parking brake (Hand type) (if equipped)		-	I	-	I	-	I	-	I
Steering gear rack, linkage and boots		I	I	I	I	I	I	I	I

Number of months or driving distance, whichever comes first								
Months	12	24	36	48	60	72	84	96
Km X 1,000	10	20	30	40	50	60	70	80
Suspension ball joints	I	I	I	I	I	I	I	I
Tyre (pressure & tread wear)	I	I	I	I	I	I	I	I
Battery condition	-	I	-	I	-	I	-	I

I: Inspect and if necessary, adjust, correct, clean or replace.

R: Replace or change.

Normal Maintenance Schedule - Turbo Model [For Australia and New Zealand]

MAINTENANCE ITEM		MAINTENANCE OPERATION	MAINTENANCE INTERVALS	DRIVING CONDITION
Engine oil and engine oil filter	(Petrol) 1.6 T-GDi	R	Every 5,000 km or 6 months	A, B, C, D, E, F, G, H, I, J, K, L
Spark plugs		R	More frequently	A, B, F, G, H, I, K
Dual clutch transmission (DCT) fluid		R	Every 120,000 km	C, D, F, G, H, I, J
Drive shaft and boots		I	More frequently	C, D, E, F, G, H, I, J
Air cleaner filter		R	More frequently	C, E
Climate control air filter		R	More frequently	C, E, G
Brake discs, pads and calipers		I	More frequently	C, D, E, G, H, I, J, K
Parking brake (Hand type) (if equipped)		I	More frequently	C, D, G, H
Steering gear rack, linkage and boots		I	More frequently	C, D, E, F, G
Suspension ball joints		I	More frequently	C, D, E, G, H, I

SEVERE DRIVING CONDITIONS

A : Repeatedly driving short distance of less than 8 km in normal temperature or less than 16 km in freezing temperature.

B : Extensive engine idling or low speed driving for long distances.

C : Driving on rough, dusty, muddy, unpaved, graveled or saltspread roads.

D : Driving in areas using salt or other corrosive materials or in very cold weather

E : Driving in heavy dust condition.

F : Driving in heavy traffic area.

G : Driving on uphill, downhill, or mountain roads repeatedly.

H : Using for towing or camping, and driving with loading on the roof

I : Driving for patrol car, taxi, other commercial use of vehicle towing.

J : Frequently driving under high speed or rapid acceleration/deceleration

K : Frequently driving in stop-and-go conditions.

L : Engine oil usage which is not recommended (Mineral type, Semi synthetic, Lower grade spec, etc.)

Normal maintenance schedule - for Europe (Except Russia)

The following maintenance services must be performed to ensure good emission control and performance. Keep receipts for all vehicle emission services to protect your warranty. Where both mileage and time are shown, the frequency of service is determined by whichever occurs first.

NO.	ITEM	REMARK
* 1	Fuel additives (Petrol)	Kia recommends that you use unleaded petrol which has an octane rating of RON (Research Octane Number) 95 / AKI (Anti Knock Index) 91 or higher (for Europe) or Octane Rating of RON (Research Octane Number) 91 / AKI (Anti-Knock Index) 87 or higher (except Europe). For customers who do not use good quality petrols including fuel additives regularly, and have problems starting or the engine does not run smoothly, one bottle of additives should be added to the fuel tank when the engine oil is replaced. Additives are available from a professional workshop along with information on how to use them. Kia recommends to visit an authorised Kia dealer/service partner. Do not mix other additives.
* 2	Engine oil and engine oil filter	As it is normal for engine oil to be consumed during driving, the engine oil level should be checked on regular basis. The engine oil change interval for normal operating conditions is based on the use of the recommended engine specification. If the recommended engine oil specification is not used, then replace the engine oil according to the maintenance schedule under severe operating conditions.
* 3	Coolant (Engine)	When adding coolant, use only deionized water or soft water for your vehicle and never mix hard water in the coolant filled at the factory. An improper coolant mixture can result in serious malfunction or engine damage.
* 4	Spark plug	For your convenience, it can be replaced prior to it's interval when you do maintenance of other items.
* 5	Manual transmission fluid / Dual clutch transmission (DCT) fluid	Manual transmission fluid (or Dual clutch transmission (DCT) fluid) should be changed anytime it has been submerged in water.
* 6	Drive belts (Engine)	<ul style="list-style-type: none"> Adjust alternator, water pump and air conditioner drive belt. Inspect and if necessary repair or replace. Inspect drive belt tensioner, idler and alternator pulley and if necessary correct or replace.

NO.	ITEM	REMARK
* 7	Valve clearance	Inspect for excessive valve noise and/or engine vibration and adjust if necessary. In this case, have the system checked by a professional workshop. Kia recommends to visit an authorised Kia dealer/service partner.

I: Inspect and if necessary, adjust, correct, clean or replace.

R: Replace or change.

MAINTENANCE INTERVALS / MAINTENANCE ITEM	Normal Maintenance Schedule - For Europe (Except Russia)									
	Number of months or driving distance, whichever comes first									
	Months	24	48	72	96	120	144	168	192	
	Miles×1,000	20	40	60	80	100	120	140	160	
	Km×1,000	30	60	90	120	150	180	210	240	
Fuel additives (Petrol) ^{*1}	(Petrol) 1.6 T-GDi	Add every 15,000 km (10,000 miles) or 12 months								
Engine oil and engine oil filter ^{*2}	(Petrol) 1.6 MPI	Replace every 15,000km(10,000miles) or 12 months								
	(Petrol) 2.0 MPI									
	(Petrol) 1.6 T-GDi									
	Smartstream G1.6									
Climate control air filter	R	R	R	R	R	R	R	R		
Coolant (Engine) ^{*3}	At first, Replace 210,000 km (140,000 miles) or 120 months After that, Replace every 30,000 km (20,000 miles) or 24 months									
Spark plugs ^{*4}	(Petrol) 1.6 MPI	Replace every 60,000 km (40,000 miles)								
	(Petrol) 2.0 MPI	Replace every 150,000km (100,000 miles)								
	(Petrol) 1.6 T-GDi	Replace every 75,000 km (50,000 miles)								
	Smartstream G1.6	Replace every 150,000km (100,000 miles)								
Brake/clutch fluid	Inspect every 15,000 km (10,000 miles) or 12 months Replace every 30,000 km (20,000 miles) or 24 months									
Manual transmission fluid ^{*5} (if equipped)	No service required									
Dual clutch transmission (DCT) fluid ^{*5} (if equipped)	No service required									
Air cleaner filter	I	R	I	R	I	R	I	R		

MAINTENANCE INTERVALS / MAINTENANCE ITEM		Normal Maintenance Schedule - For Europe (Except Russia)								
		Number of months or driving distance, whichever comes first								
		Months	24	48	72	96	120	144	168	192
		Miles×1,000	20	40	60	80	100	120	140	160
		Km×1,000	30	60	90	120	150	180	210	240
Battery (12V) condition										
Intercooler, in/out hose, air intake hose	(Petrol engine) 1.6 T-GDi									
Vacuum hoses and crankcase ventilation hoses (Petrol)										
Air conditioner refrigerant										
Exhaust system										
Brake lines, hoses and connections										
Parking brake (Hand type) (if equipped)										
Brake discs and pads										
Suspension ball joints										
Steering gear rack, linkage and boots										
Air conditioner compressor										
Drive shaft and boots										
tyre (pressure & tread wear)										
Cooling system		-								
Vapour hose and fuel filler cap (Petrol)										
Fuel lines, hoses and connections (Petrol)		-		-		-		-		
Fuel tank air filter (Petrol)										
Drive belts (Engine) ⁶		-	-							
Valve clearance ⁷	(Petrol) 1.6 MPI	-	-		-	-		-	-	-
	(Petrol) 1.6 T-GDi									
Automatic transmission fluid (if equipped)		No service required								
Intelligent Variable Transmission (IVT) fluid (if equipped)		No service required								

- Fuel filter (Petrol engine): The fuel filter is considered to be maintenance free but periodic inspection is recommended for this maintenance schedule depends on fuel quality.
 - If there are some important safety matters like fuel flow restriction, surging, loss of power, hard starting problem etc, replace the fuel filter immediately regard-

less of maintenance schedule and consult an authorised Kia dealer/service partner for details.

Maintenance under severe usage conditions - for Europe (Except Russia)

I: Inspect and if necessary, adjust, correct, clean or replace.

R: Replace or change.

MAINTENANCE ITEM		MAINTENANCE OPERATION	MAINTENANCE INTERVALS	DRIVING CONDITION
Engine oil and engine oil filter	(Petrol) 1.6 MPI	R	Every 7,500km (5,000 miles) or 6 months	A, B, C, D, E, F, G, H, I, J, K, L
	(Petrol) 2.0 MPI	R	Every 7,500km (5,000 miles) or 6 months	A, B, C, D, E, F, G, H, I, J, K, L
	(Petrol) 1.6 T-GDi	R	Every 7,500km (5,000 miles) or 6 months	A, B, C, D, E, F, G, H, I, J, K, L
	Smartstream G1.6	R	Every 7,500 km (5,000 miles) or 6 months	A, B, C, D, E, F, G, H, I, J, K, L
Automatic transmission fluid		R	Every 90,000 km (60,000 miles)	A, C, F, G, H, I, J, K
Intelligent Variable Transmission (IVT) fluid (if equipped)		R	Every 90,000 km (60,000 miles)	A, C, F, G, H, I, J, K
Manual transmission fluid		R	Every 120,000 km (80,000 miles)	C, D, F, G, H, I, J
Dual clutch transmission (DCT) fluid		R	Replace every 120,000 km (80,000 miles)	C, D, F, G, H, I, J
Climate control air filter		R	More frequently	C, E, G
Air cleaner filter		R	More frequently	C, E
Spark plugs		R	More frequently	A, B, F, G, H, I, K
Parking brake (Hand type) (if equipped)		I	More frequently	C, D, G, H
Brake discs, pads and calipers		I	More frequently	C, D, E, G, H, I, J, K
Suspension ball joints		I	More frequently	C, D, E, G, H, I

MAINTENANCE ITEM	MAINTENANCE OPERATION	MAINTENANCE INTERVALS	DRIVING CONDITION
Steering gear rack, linkage and boots	I	More frequently	C, D, E, F, G
Drive shaft and boots	I	More frequently	C, D, E, F, G, H, I, J

Severe driving conditions

- A: Repeatedly driving short distance of less than 8 km (5 miles) in normal temperature or less than 16 km (10 miles) in freezing temperature.
- B: Extensive engine idling or low speed driving for long distances.
- C: Driving on rough, dusty, muddy, unpaved, graveled or saltspread roads.
- D: Driving in areas using salt or other corrosive materials or in very cold weather
- E: Driving in heavy dust condition.
- F: Driving in heavy traffic area.
- G: Driving on uphill, downhill, or mountain roads repeatedly.
- H: Using for towing or camping, and driving with loading on the roof.
- I: Driving for patrol car, taxi, other commercial use of vehicle towing.
- J: Frequently driving under high speed or rapid acceleration/deceleration
- K: Frequently driving in stop-and-go conditions.
- L: Engine oil usage which is not recommended (Mineral type, Semi synthetic, Lower grade spec, etc.)

Normal maintenance schedule - except Europe (Including Russia)

The following maintenance services must be performed to ensure good emission control and performance. Keep receipts for all vehicle emission services to protect your warranty. Where both mileage and time are shown, the frequency of service is determined by whichever occurs first.

NO.	ITEM	REMARK
* 1	Fuel additives (Petrol)	<p>Kia recommends that you use unleaded petrol which has an octane rating of RON (Research Octane Number) 95 / AKI (Anti Knock Index) 91 or higher (for Europe) or Octane Rating of RON (Research Octane Number) 91 / AKI (Anti-Knock Index) 87 or higher (except Europe).</p> <p>For customers who do not use good quality petrols including fuel additives regularly, and have problems starting or the engine does not run smoothly, one bottle of additives should be added to the fuel tank when the engine oil is replaced. Additives are available from a professional workshop along with information on how to use them. Kia recommends to visit an authorised Kia dealer/service partner. Do not mix other additives.</p>
* 2	Engine oil and engine oil filter	<p>As it is normal for engine oil to be consumed during driving, the engine oil level should be checked on regular basis.</p> <p>The engine oil change interval for normal operating conditions is based on the use of the recommended engine specification. If the recommended engine oil specification is not used, then replace the engine oil according to the maintenance schedule under severe operating conditions.</p>
* 3	Coolant (Engine)	<p>When adding coolant, use only deionized water or soft water for your vehicle and never mix hard water in the coolant filled at the factory. An improper coolant mixture can result in serious malfunction or engine damage.</p>
* 4	Spark plug	<p>For your convenience, it can be replaced prior to it's interval when you do maintenance of other items.</p>
* 5	Drive belts (Engine)	<ul style="list-style-type: none"> • Adjust alternator, water pump and air conditioner drive belt. Inspect and if necessary repair or replace. • Inspect drive belt tensioner, idler and alternator pulley and if necessary correct or replace.
* 6	Manual transmission fluid / Dual clutch transmission (DCT) fluid	<p>Manual transmission fluid (or Dual clutch transmission (DCT) fluid) should be changed anytime it has been submerged in water.</p>

NO.	ITEM	REMARK
* 7	Valve clearance	Inspect for excessive valve noise and/or engine vibration and adjust if necessary. In this case, have the system checked by a professional workshop. Kia recommends to visit an authorised Kia dealer/service partner.

I: Inspect and if necessary, adjust, correct, clean or replace.

R: Replace or change.

MAINTENANCE INTERVALS/ MAINTENANCE ITEM	Normal Maintenance Schedule - Except Europe (Including Russia)									
	Number of months or driving distance, whichever comes first									
	Months	12	24	36	48	60	72	84	96	
	Miles×1,000	10	20	30	40	50	60	70	80	
	Km×1,000	15	30	45	60	75	90	105	120	
Fuel additives (Petrol) ^{*1}	(Petrol) 1.6 T-GDi	For Australia and New Zealand	Add every 10,000 km (6,500 miles) or 12 months							
		Except Australia and New Zealand, China, Brazil	Add every 10,000 km (6,500 miles) or 6 months							
		For China, Brazil	Add every 5,000 km (3,000 miles) or 6 months							
		For Mexico	Add every 10,000 km (6,500 miles) or 6 months							

MAINTENANCE INTERVALS/ MAINTENANCE ITEM	Normal Maintenance Schedule - Except Europe (Including Russia)										
	Number of months or driving distance, whichever comes first										
	Months	12	24	36	48	60	72	84	96		
	Miles×1,000	10	20	30	40	50	60	70	80		
	Km×1,000	15	30	45	60	75	90	105	120		
Engine oil and engine oil filter ²	(Petrol) 1.6 MPI	Except Middle East, India, Libya, Algeria, Morocco, Tunisia, Sudan, Egypt, Iran, Brazil, Central & South America, China	R	R	R	R	R	R	R	R	
		For Middle East, India, Libya, Algeria, Morocco, Tunisia, Sudan, Egypt, Iran, Brazil, Central & South America	Replace every 10,000km (6,500miles) or 12 months								
		For China	Replace Every 5,000 km (3,000 miles) or 6 months								
	(Petrol) 1.6 T-GDi	Except Middle East, India, Libya, Algeria, Morocco, Tunisia, Sudan, Egypt, Iran, Brazil, Central & South America, China	Replace every 10,000km(6,500miles) or 12 months								
		For Middle East, India, Libya, Algeria, Morocco, Tunisia, Sudan, Egypt, Iran, Brazil, Central & South America	Replace every 10,000km (6,500 miles) or 12 months								
		For China	Replace every 5,000 km (3,000 miles) or 6 months								
		For Mexico	Replace every 10,000 km (6,500 miles) or 6 months								
	(Petrol) 2.0 MPI	Except Middle East, India, Libya, Algeria, Morocco, Tunisia, Sudan, Egypt, Iran, Brazil, Central & South America,China	R	R	R	R	R	R	R	R	R
		For Middle East, India, Libya, Algeria, Morocco, Tunisia, Sudan, Egypt, Iran, Brazil, Central & South America	Replace every 10,000km (6,500 miles) or 12 months								
For China		Replace every 5,000 km (3,000miles) or 6 months									

MAINTENANCE INTERVALS/ MAINTENANCE ITEM	Normal Maintenance Schedule - Except Europe (Including Russia)									
	Number of months or driving distance, whichever comes first									
	Months	12	24	36	48	60	72	84	96	
	Miles×1,000	10	20	30	40	50	60	70	80	
	Km×1,000	15	30	45	60	75	90	105	120	
Engine oil and engine oil filter ²	Smartstream G1.6	Except Middle East, India, Libya, Algeria, Morocco, Tunisia, Sudan, Egypt, Iran, Brazil, Central & South America, China	R	R	R	R	R	R	R	
		For Middle East, India, Libya, Algeria, Morocco, Tunisia, Sudan, Egypt, Iran, Brazil, Central & South America	Replace every 10,000km (6,500 miles) or 12 months							
		For China	Replace every 5,000 km (3,000 miles) or 6 months							
Climate control air filter	Except Australia and New Zealand		R	R	R	R	R	R	R	
	For Australia and New Zealand		I	R	I	R	I	R	I	
Coolant (Engine) ³		At first, Replace 210,000 km (140,000 miles) or 120 months after that, Replace every 30,000 km (20,000 miles) or 24 months								
Spark plugs ⁴	(Petrol) 1.6 MPI	Unleaded	Replace every 60,000 km (40,000 miles)							
		Leaded	Replace every 30,000 km (20,000 miles)							
	(Petrol) 2.0 MPI	Unleaded	Replace every 150,000 km (100,000 miles)							
		Leaded	Replace every 75,000 km (50,000 miles)							
	(Petrol) 1.6 T-GDi		Replace every 75,000 km (50,000 miles)							
	Smartstream G1.6		Replace every 150,000 km (100,000 miles)							

MAINTENANCE INTERVALS/ MAINTENANCE ITEM	Normal Maintenance Schedule - Except Europe (Including Russia)								
	Number of months or driving distance, whichever comes first								
	Months	12	24	36	48	60	72	84	96
	Miles×1,000	10	20	30	40	50	60	70	80
	Km×1,000	15	30	45	60	75	90	105	120
Air cleaner filter (Petrol)	For China, India, Middle East	R	R	R	R	R	R	R	R
	Except China, India, Middle East	I	I	R	I	I	R	I	I
Brake/clutch fluid		I	I	R	I	I	R	I	I
Intercooler, in/out hose, air intake hose	(Petrol) 1.6 T-GDi								
Air conditioner refrigerant									
Suspension ball joints		I	I	I	I	I	I	I	I
Steering gear rack, linkage and boots									
Air conditioner compressor									
Tyre (pressure & tread wear)									
Battery (12V) condition	For Middle East	Inspect every 10,000 km (6,500 miles) or 6 months							
	Except Middle East	-	I	-	I	-	I	-	I
Parking brake (Hand type) (if equipped)									
Brake lines, hoses and connections									
Brake discs and pads									
Exhaust system		-	I	-	I	-	I	-	I
Vacuum hoses and crankcase ventilation hoses (Petrol)									
Drive shaft and boots									
Fuel filter (Petrol)	For China, Brazil	-	I	-	R	-	I	-	R
Fuel tank air filter (Petrol)		-	I	-	R	-	I	-	R
Drive belts (Engine) ⁵		-	-	I	I	I	I	I	I
Cooling system		-	-	-	I	-	I	-	I
Fuel lines, hoses and connections (Petrol)		-	-	-	I	-	-	-	I
Vapour hose and fuel filler cap (Petrol)		-	-	-	I	-	-	-	I
Manual transmission fluid ⁶ (if equipped)		No service required							
Dual clutch transmission (DCT) fluid ⁶ (if equipped)		No service required							

MAINTENANCE INTERVALS/ MAINTENANCE ITEM	Normal Maintenance Schedule - Except Europe (Including Russia)								
	Number of months or driving distance, whichever comes first								
	Months	12	24	36	48	60	72	84	96
	Miles×1,000	10	20	30	40	50	60	70	80
	Km×1,000	15	30	45	60	75	90	105	120
Valve clearance ⁷	(Petrol) 1.6 MPI	-	-	-	-	-		-	-
	(Petrol) 1.6 T-GDi	-	-	-	-	-	-	-	-
Automatic transmission fluid (if equipped)	No service required								
Intelligent Variable Transmission (IVT) fluid (if equipped)	No service required								
ERA-GLONASS system (if equipped)									
ERA-GLONASS system battery (if equipped)	Replace every 3 years								

- Fuel filter: The fuel filter is considered to be maintenance free but periodic inspection is recommended for this maintenance schedule depends on fuel quality.
 - If there are some important safety matters like fuel flow restriction, surging, loss of power, hard starting problem etc, replace the fuel filter immediately regardless of maintenance schedule and consult an authorised Kia dealer/service partner for details.

Maintenance under severe usage conditions - except Europe (Including Russia)

I: Inspect and if necessary, adjust, correct, clean or replace.

R: Replace or change.

MAINTENANCE ITEM			MAINTENANCE OPERATION	MAINTENANCE INTERVALS	DRIVING CONDITION
Engine oil and engine oil filter	(Petrol) 1.6 MPI	Except Middle East, India, Libya, Algeria, Morocco, Tunisia, Sudan, Egypt, Iran, Brazil, Central & South America, China	R	Every 7,500 km (5,000 miles) or 6 months	A, B, C, D, E, F, G, H, I, J, K, L
		For Middle East, India, Libya, Algeria, Morocco, Tunisia, Sudan, Egypt, Iran, Brazil, Central & South America	R	Every 5,000 km (3,000 miles) or 6 months	
		For China	R	Every 5,000 km (3,000 miles) or 3 months	
	(Petrol) 1.6 T-GDi	Except Middle East, India, Libya, Algeria, Morocco, Tunisia, Sudan, Egypt, Iran, Brazil, Central & South America, China	R	Every 5,000 km (3,000 miles) or 6 months	
		For Middle East, India, Libya, Algeria, Morocco, Tunisia, Sudan, Egypt, Iran, Brazil, Central & South America	R	Every 5,000 km (3,000 miles) or 6 months	
		For China, Mexico	R	Every 5,000 km (3,000 miles) or 3 months	

MAINTENANCE ITEM			MAINTENANCE OPERATION	MAINTENANCE INTERVALS	DRIVING CONDITION
Engine oil and engine oil filter	(Petrol) 2.0 MPI	Except Middle East, India, Libia, Algeria, Morocco, Tunisia, Sudan, Egypt, Iran, Brazil, Central & South America, China	R	Every 7,500km (5,000 miles) or 6 months	A, B, C, D, E, F, G, H, I, J, K, L
		For Middle East, India, Libia, Algeria, Morocco, Tunisia, Sudan, Egypt, Iran, Brazil, Central & South America	R	Every 5,000 km (3,000 miles) or 6 months	
		For China	R	Every 5,000 km (3,000 miles) or 6 months	
		For Mexico	R	Every 5,000 km (3,000 miles) or 3 months	
	Smartstream G1.6	Except Middle East, India, Libia, Algeria, Morocco, Tunisia, Sudan, Egypt, Iran, Brazil, Central & South America, China	R	Every 7,500km (5,000 miles) or 6 months	
		For Middle East, India, Libia, Algeria, Morocco, Tunisia, Sudan, Egypt, Iran, Brazil, Central & South America	R	Every 5,000 km (3,000 miles) or 6 months	
		For China	R	Every 5,000 km (3,000 miles) or 3 months	
	Automatic transmission fluid			R	
Intelligent Variable Transmission (IVT) fluid (if equipped)			R	Every 90,000 km (60,000 miles)	A, C, F, G, H, I, J, K

MAINTENANCE ITEM	MAINTENANCE OPERATION	MAINTENANCE INTERVALS	DRIVING CONDITION
Manual transmission fluid	R	Every 120,000 km (80,000 miles)	C, D, F, G, H, I, J
Dual clutch transmission (DCT) fluid	R	Every 120,000 km (80,000 miles)	C, D, F, G, H, I, J
Climate control air filter	R	More frequently	C, E, G
Air cleaner filter	R	More frequently	C, E
Spark plugs	R	More frequently	A, B, F, G, H, I, K
Parking brake (Hand type) (if equipped)	I	More frequently	C, D, G, H
Brake discs, pads and calipers	I	More frequently	C, D, E, G, H, I, J, K
Suspension ball joints	I	More frequently	C, D, E, G, H, I
Steering gear rack, linkage and boots	I	More frequently	C, D, E, F, G
Drive shaft and boots	I	More frequently	C, D, E, F, G, H, I, J
ERA-GLONASS system battery (if equipped)	I	Every 7,500 km (5,000 miles) or 6 months	A, K

Severe driving conditions

- A: Repeatedly driving short distance of less than 8 km (5 miles) in normal temperature or less than 16 km (10 miles) in freezing temperature.
- B: Extensive engine idling or low speed driving for long distances.
- C: Driving on rough, dusty, muddy, unpaved, graveled or saltspread roads.
- D: Driving in areas using salt or other corrosive materials or in very cold weather

- E: Driving in heavy dust condition.
- F: Driving in heavy traffic area.
- G: Driving on uphill, downhill, or mountain roads repeatedly.
- H: Using for towing or camping, and driving with loading on the roof.
- I: Driving for patrol car, taxi, other commercial use of vehicle towing.
- J: Frequently driving under high speed or rapid acceleration/deceleration.
- K: Frequently driving in stop-and-go conditions.

- L: Engine oil usage which is not recommended (Mineral type, Semisynthetic, Lower grade spec, etc.)

Explanation of scheduled maintenance items

Engine oil and filter

The engine oil and filter should be changed at the intervals specified in the maintenance schedule. If the vehicle is being driven in severe conditions, more frequent oil and filter changes are required.

Drive belts

Inspect all drive belts for evidence of cuts, cracks, excessive wear or oil saturation and replace if necessary. Drive belts should be checked periodically for proper tension and adjusted as necessary.

CAUTION

When you are inspecting the belt, place the ignition switch in the LOCK/OFF or ACC position.

Fuel filter cartridge (for diesel engine)

A clogged filter can limit the speed at which the vehicle may be driven, damage the emission system and cause multiple issues such as hard starting. If an excessive amount of foreign matter accumulates in the fuel tank, the filter may require replacement more frequently.

After installing a new filter, run the engine for several minutes, and check for leaks at the connections. Have the fuel filter replaced by a professional workshop. Kia recommends to visit an authorised Kia dealer/service partner.

Fuel filter (for petrol engine)

Kia petrol vehicle is equipped a lifetime fuel filter that integrated with the fuel

tank. Regular maintenance or replacement is not needed but depends on fuel quality. If there are some important safety matters like fuel flow restriction, surging, loss of power, hard starting problem etc, fuel filter inspection or replace is needed.

Have the fuel filter inspected or replaced by a professional workshop. Kia recommends to visit an authorised Kia dealer/service partner.

Fuel lines, fuel hoses and connections

Check the fuel lines, fuel hoses and connections for leakage and damage. Have the fuel lines, fuel hoses and connections replaced by a professional workshop. Kia recommends to visit an authorised Kia dealer/service partner.

⚠ WARNING

Diesel only

Never work on the injection system with the engine running or within 30 seconds after shutting off the engine. High pressure pump, rail, injectors and high pressure pipes are subject to high pressure even after the engine stops. The fuel jet produced by fuel leaks may cause serious injury, if it touches the body. People wearing a cardiac pacemaker should maintain a distance of at least 30cm from the ECU or wiring harness within the engine room whilst the engine is running, since the high currents in the Common Rail system produce considerable magnetic fields.

Vapour hose and fuel filler cap (for petrol engine)

The vapour hose and fuel filler cap should be inspected at those intervals specified in the maintenance schedule.

Make sure that a new vapour hose or fuel filler cap is correctly replaced.

Vacuum crankcase ventilation hoses (if equipped)

Inspect the surface of hoses for evidence of heat and/or mechanical damage. Hard and brittle rubber, cracking, tears, cuts, abrasions, and excessive swelling indicate deterioration. Particular attention should be paid to examine those hose surfaces nearest to high heat sources, such as the exhaust manifold.

Inspect the hose routing to assure that the hoses do not come in contact with any heat source, sharp edges or moving component which might cause heat damage or mechanical wear. Inspect all hose connections, such as clamps and couplings, to make sure they are secure, and that no leaks are present. Hoses should be replaced immediately if there is any evidence of deterioration or damage.

Air cleaner filter

Have the air cleaner filter replaced by a professional workshop. Kia recommends to visit an authorised Kia dealer/service partner.

Spark plugs (for petrol engine)

Make sure to install new spark plugs of the correct heat range.

When assembling parts, be sure to wipe the inside and outside of the boot bottom of the ignition coil and the insulator of the spark plug with a soft cloth to prevent contamination of the spark plug insulator.

⚠ WARNING

Do not disconnect and inspect spark plugs when the engine is hot. You may burn yourself.

Cooling system

Check the cooling system components, such as the radiator, coolant reservoir, hoses and connections for leakage and damage. Replace any damaged parts.

Coolant

The coolant should be changed at the intervals specified in the maintenance schedule.

Dual clutch transmission fluid (if equipped)

Inspect the dual clutch transmission fluid according to the maintenance schedule.

Automatic transmission fluid (if equipped)

Automatic transmission fluid should not be checked under normal usage conditions. Have the automatic transmission fluid changed by a professional workshop according to the maintenance schedule. Kia recommends to visit an authorised Kia dealer/service partner.

*** NOTICE**

Automatic transmission fluid colour is basically red.

As the vehicle is driven, the automatic transmission fluid will begin to look darker. It is normal condition and you should not judge the need to replace the fluid based upon the changed colour.

⚠ CAUTION

The use of a non-specified fluid could result in transmission malfunction and failure.

Use only specified automatic transmission fluid. (Refer to "Recommended lubricants and capacities" on page 9-10.)

Brake hoses and lines

Visually check for proper installation, chafing, cracks, deterioration and any leakage. Replace any deteriorated or damaged parts immediately.

Brake fluid

Check the brake fluid level in the brake fluid reservoir. The level should be between "MIN" and "MAX" marks on the side of the reservoir. Use only hydraulic brake fluid conforming to DOT 4 specification.

Parking brake

Inspect the parking brake system including the parking brake pedal and cables.

Brake discs, pads and calipers

Check the pads for excessive wear, discs for run out and wear, and calipers for fluid leakage.

For more information on checking the pads or lining wear limit, we recommend to refer to the Kia web site.

(www.kia-hotline.com)

Suspension mounting bolts

Check the suspension connections for looseness or damage. Retighten to the specified torque.

Steering gear box, linkage & boots/lower arm ball joint

With the vehicle stopped and engine off, check for excessive free-play in the steering wheel.

Check the linkage for bends or damage. Check the dust boots and ball joints for deterioration, cracks, or damage. Replace any damaged parts.

Drive shafts and boots

Check the drive shafts, boots and clamps for cracks, deterioration, or damage. Replace any damaged parts and, if necessary, repack the grease.

Air conditioning refrigerant

Check the air conditioning lines and connections for leakage and damage.

Propeller shaft (if equipped)

Check the propeller shaft, boots, clamps, rubber coupling and centre bearing rubber for cracks, deterioration, or damage. Replace any damaged parts and if necessary, repack the grease.

Checking fluid levels

When checking engine oil, engine coolant, brake fluid, and washer fluid, always be sure to clean the area around any filler plug, drain plug, or dipstick before checking or draining any lubricant or fluid. This is especially important in dusty or sandy areas and when the vehicle is used on unpaved roads. Cleaning the plug and dipstick areas will prevent dirt and grit from entering the engine and other mechanisms that could be damaged.

Engine oil (Petrol)

Checking the engine oil level

Engine oil is used for lubricating, cooling, and operating various hydraulic components in the engine. Engine oil consumption whilst driving is normal, and it is necessary to check and refill the engine oil regularly. Also, check and refill the oil level within the recommended maintenance schedule to prevent deterioration of oil performance. Check the engine oil following the below procedure.

(Petrol) 1.6 MPI

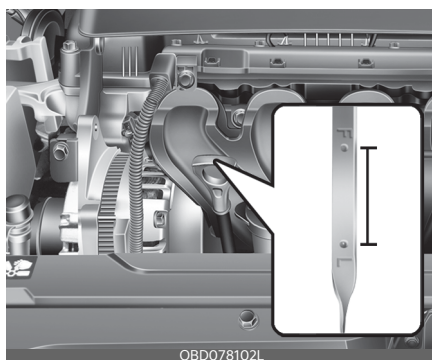

(Petrol) 2.0 MPI

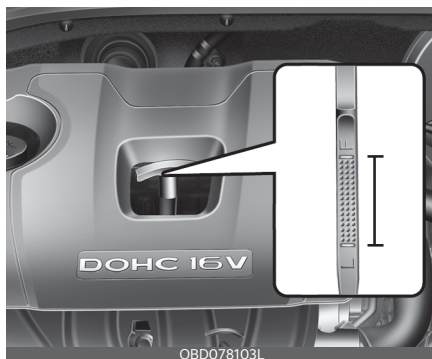

(Petrol) 1.6 T-GDi

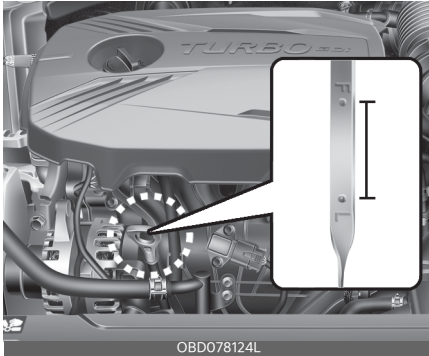

Smartstream G1.6

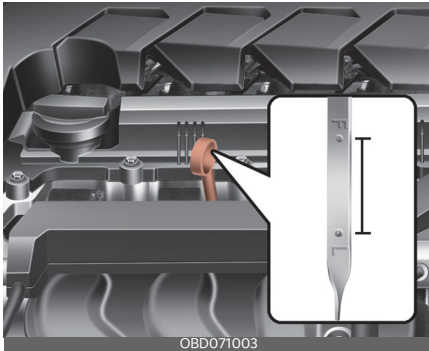

1. Be sure the vehicle is on level ground.
2. Start the engine and allow it to reach normal operating temperature.
3. Turn the engine off and wait for about 15 minutes (with oil filler cap and dipstick detached) for the oil to return to the oil pan.
4. Wipe the dipstick clean and re-insert it fully.
5. Pull the dipstick out again and check the level. Check if the oil level is between the F-L line, and if it is below the L line, add enough oil to bring the level to F line.

⚠ WARNING

Radiator hose

Be very careful not to touch the radiator hose when checking or adding the engine oil as it may be hot enough to burn you.

⚠ CAUTION

When you wipe the oil level gauge, you should wipe it with a clean cloth. When mixed with debris, it can cause engine damage.

(Petrol) 1.6 MPI

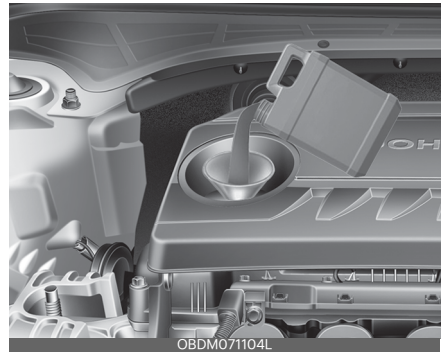

(Petrol) 2.0 MPI

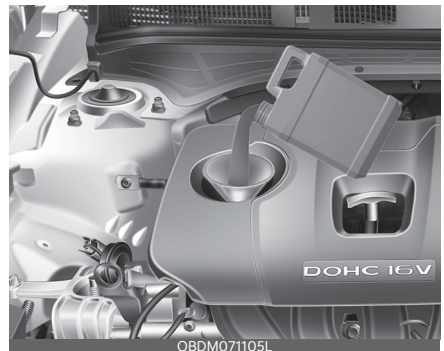

(Petrol) 1.6 T-GDi

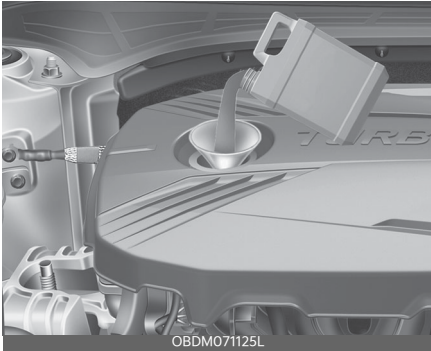

Smartstream G1.6

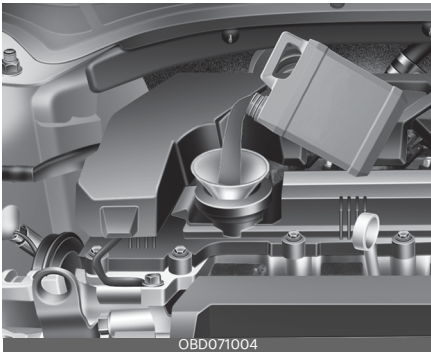

Use a funnel to help prevent oil from being spilled on engine components.

Use only the specified engine oil. (Refer to "Recommended lubricants and capacities" on page 9-10.)

- Do not spill engine oil when adding or changing engine oil. Wipe off spilled oil immediately.
- The engine oil consumption may increase whilst you break in a new vehicle and it will be stabilized after driving (6,000 km (4,000 miles)).
- The engine oil consumption can be affected by driving habits, climate conditions, traffic conditions, oil quality, etc. Therefore, it is recommended

that you inspect the engine oil level regularly and refill it if necessary.

Changing the engine oil and filter

Have the engine oil and filter replaced by a professional workshop. Kia recommends to visit an authorised Kia dealer/service partner.

- If the maintenance schedule to replace engine oil is exceeded, the engine oil performance may deteriorate, and the engine condition may be affected. Therefore, replace the engine oil according to the maintenance schedule.
- To keep the engine in optimal condition, use the recommended engine oil and filter. If the recommended engine oil and filter are not used replace it according to the maintenance schedule under severe usage conditions.
- The purpose of the maintenance schedule for engine oil replacement is to prevent oil deterioration and it is irrelevant to oil consumption. Check and refill engine oil regularly.

WARNING

Used engine oil

Used engine oil may cause skin irritation or cancer if left in contact with the skin for prolonged periods of time. Used engine oil contains chemicals that have caused cancer in laboratory animals. Always protect your skin by washing your hands thoroughly with soap and warm water as soon as possible after handling used oil. Do not leave used engine oil within the reach of children.

⚠ CAUTION

The engine oil is very hot immediately after the vehicle has been driven and can cause burns during replacement. Replace the engine oil after the engine oil has cooled down.

Engine Coolant

The high-pressure cooling system has a reservoir filled with year round anti-freeze coolant. The reservoir is filled at the factory.

Check the antifreeze protection and coolant level at least once a year, at the beginning of the winter season, and before travelling to a colder climate.

⚠ CAUTION

- When the engine overheats from low engine coolant, suddenly adding engine coolant may cause cracks in the engine. To prevent damage, add engine coolant slowly in small quantities.
- Do not drive with no engine coolant. It may cause water pump failure and engine seizure, etc.

Checking the coolant level**⚠ WARNING****Removing radiator cap**

- Never attempt to remove the radiator cap whilst the engine is operating or hot. Doing so might lead to cooling system and engine damage. Also, hot coolant or steam could cause serious personal injury.
- Turn the engine off and wait until it cools down. Use extreme care when removing the radiator cap. Wrap a thick towel around it, and turn it counterclockwise slowly to the first stop. Step back whilst the pressure is released from the cooling system. When you are sure all the pressure has been released, press down on the cap, using a thick towel, and continue turning counterclockwise to remove it.

- Even if the engine is not operating, do not remove the radiator cap or the drain plug whilst the engine and radiator are hot. Hot coolant and steam may still blow out under pressure, causing serious injury.

WARNING



The electric motor (cooling fan) is controlled by engine coolant temperature, refrigerant pressure and vehicle speed. It may sometimes operate even when the engine is not running. Use extreme caution when working near the blades of the cooling fan so that you are not injured by a rotating fan blades. As the engine coolant temperature decreases, the electric motor will automatically shut off. This is a normal condition.

The electric motor (cooling fan) may operate until you disconnect the negative battery cable.

(Petrol) 1.6 MPI/ (Petrol) 2.0 MPI/Smart-stream G1.6

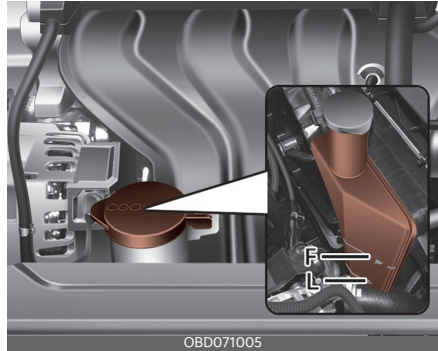

Petrol) 1.6 T-GDi

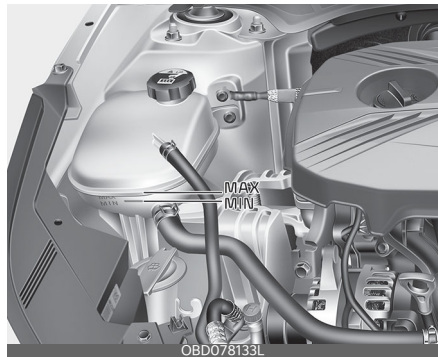

Check the condition and connections of all cooling system hoses and heater hoses. Replace any swollen or deteriorated hoses.

The coolant level should be filled between F and L (or MAX and MIN) marks on the coolant level gauge when the engine is cool.

If the coolant level is low, add enough specified coolant to provide protection against freezing and corrosion. Bring the level to F (or MAX), but do not overfill. If frequent additions are required, have the system inspected by a professional workshop. Kia recommends to visit an authorised Kia dealer/service partner.

*** NOTICE**

Make sure the coolant cap is properly closed after refill of coolant.

Otherwise the engine could be overheated whilst driving.

1. Check if the radiator cap label is straight In front.

Engine room front view



2. Make sure that the tiny protrusions inside the coolant cap should be securely interlocked.

Engine room rear view

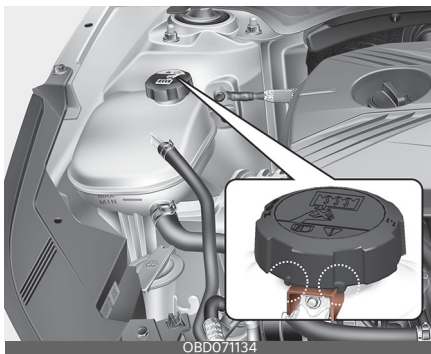

Recommended engine coolant

- When adding coolant, use only deionized water or soft water for your vehicle and never mix hard water in the

coolant filled at the factory. An improper coolant mixture can result in serious malfunction or engine damage.

- The engine in your vehicle has aluminum engine parts and must be protected by an ethylene-glycol with phosphate based coolant to prevent corrosion and freezing.
- DO NOT USE alcohol or methanol coolant or mix them with the specified coolant.
- Do not use a solution that contains more than 60% antifreeze or less than 35% antifreeze, which would reduce the effectiveness of the solution.

For mixture percentage, refer to the following table.

Ambient Temperature	Mixture Percentage (volume)	
	Antifreeze	Water
-15°C (5°F)	35	65
-25°C (-13°F)	40	60
-35°C (-31°F)	50	50
-45°C (-49°F)	60	40

(Petrol) 1.6 MPI/(Petrol) 2.0 MPI/Smart-stream G1.6

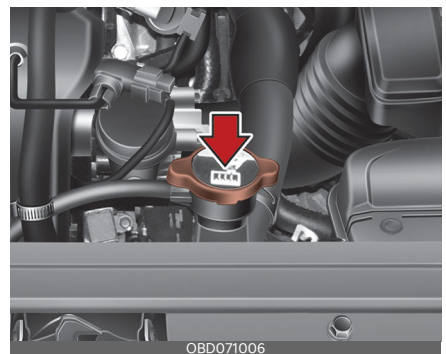

(Petrol) 1.6 T-GDi

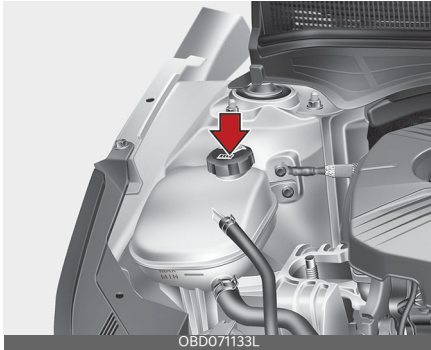

⚠ WARNING



Radiator cap

Do not remove the radiator cap when the engine and radiator are hot. Scalding hot coolant and steam may blow out under pressure causing serious injury.

Changing the coolant

Have the coolant replaced by a professional workshop. Kia recommends to visit an authorised Kia dealer/service partner.

⚠ CAUTION

Put a thick cloth around the radiator cap before refilling the coolant in order to prevent the coolant from overflowing into engine parts such as the alternator.

⚠ WARNING

Coolant

- Do not use radiator coolant or anti-freeze in the washer fluid reservoir.
- Radiator coolant can severely obscure visibility when sprayed on the wind-screen and may cause loss of vehicle

control or damage the paint and body trim.

Brake/clutch fluid (if equipped)

Checking the brake/clutch fluid level

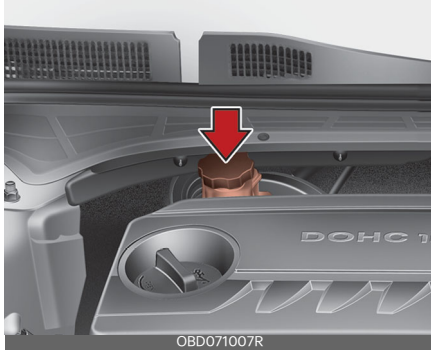

Check the fluid level in the reservoir periodically. The fluid level should be between MAX and MIN marks on the side of the reservoir.

Before removing the reservoir cap and adding brake/clutch fluid, clean the area around the reservoir cap thoroughly to prevent brake fluid contamination.

Periodically check that the fluid level in the brake fluid reservoir is between MIN and MAX. The level will fall with accumulated mileage. This is a normal condition associated with the wear of the brake linings.

If the fluid level is excessively low, have the system checked by a professional workshop. Kia recommends to visit an authorised Kia dealer/service partner.

Use only the specified brake fluid. (Refer to "Recommended lubricants and capacities" on page 9-10.)

Never mix different types of fluid.

⚠ WARNING

Loss of brake fluid

In the event the brake system requires frequent additions of fluid, have the system inspected by a professional workshop. Kia recommends to visit an authorised Kia dealer/service partner.

⚠ WARNING

Brake fluid

When changing and adding brake fluid, handle it carefully. Do not let it come in contact with your eyes. If brake fluid should come in contact with your eyes, immediately flush them with a large quantity of fresh tap water. Have your eyes examined by a doctor as soon as possible.

⚠ CAUTION

Do not allow brake fluid to contact the vehicle's body paint, as paint damage will result. Brake fluid, which has been exposed to open air for an extended time should never be used as its quality cannot be guaranteed. It should be properly disposed. Don't put in the wrong kind of fluid. A few drops of mineral based oil, such as engine oil, in your brake system can damage brake system parts.

⚠ CAUTION

To maintain your vehicle's best brake and ABS/ESC performance, use Kia genuine brake fluid or those of an equivalent standard brake fluid as in the specification. (Classification : SAE J1704 DOT4 LV, ISO4925 CLASS-6, FMVSS116 DOT-4)

Washer fluid

Checking the washer fluid level

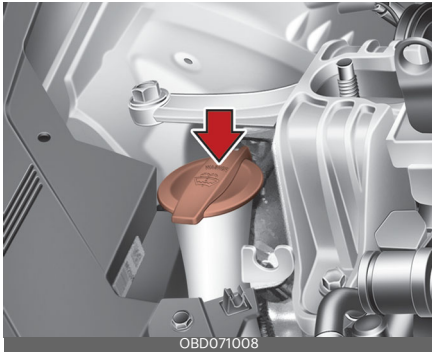

The reservoir is translucent so that you can check the level with a quick visual inspection.

Check the fluid level in the washer fluid reservoir and add fluid if necessary. Plain water may be used if washer fluid is not available. However, use washer solvent with antifreeze characteristics in cold climates to prevent freezing.

⚠ WARNING

Coolant

- Do not use radiator coolant or anti-freeze in the washer fluid reservoir.
- Radiator coolant can severely obscure visibility when sprayed on the windscreen and may cause loss of vehicle control or damage to paint and body trim.
- Windscreen Washer fluid agents contain some amounts of alcohol and can be flammable under certain circumstances. Do not allow sparks or flame to contact the washer fluid or the washer fluid reservoir. Damage to the vehicle or occupants could occur.
- Windscreen washer fluid is poisonous to humans and animals. Do not drink

and avoid contacting windscreen washer fluid. Serious injury or death could occur.

Parking brake (Hand type) (if equipped)

Checking the parking brake

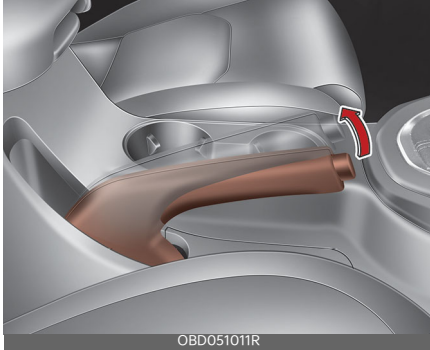

Check the stroke of the parking brake by counting the number of “clicks” heard whilst fully applying it from the released position. Also, the parking brake alone should securely hold the vehicle on a fairly steep grade. If the stroke is more or less than specified, have the system-serviced by a professional workshop. Kia recommends to visit an authorised Kia dealer/service partner.

Air cleaner

Filter replacement

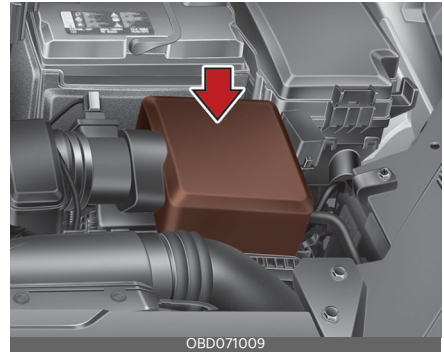

It must be replaced when necessary, and should not be washed.

1. Loosen the air cleaner cover attaching clips and open the cover.

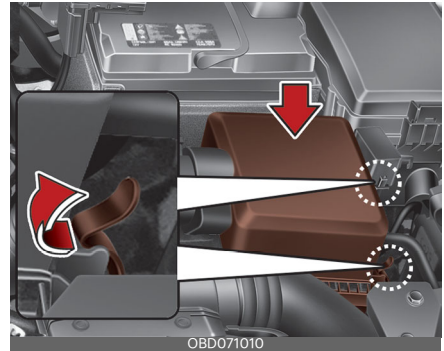

2. Wipe the inside of the air cleaner.

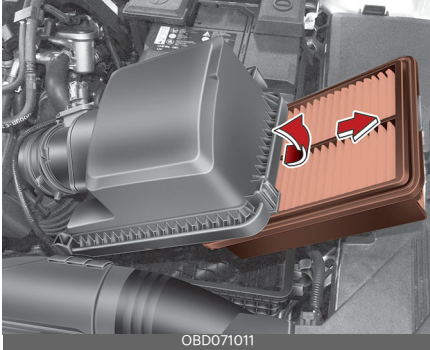

3. Replace the air cleaner filter.
4. Lock the cover with the cover attaching clips.

* NOTICE

Insert the hinge(1) and engage the clips when mounting the air cleaner cover.

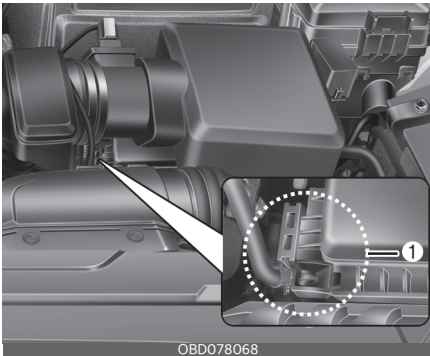

Replace the filter according to the Maintenance Schedule.

If the vehicle is operated in extremely dusty or sandy areas, replace the element more often than the usual recommended intervals. (Refer to "Scheduled maintenance service" on page 8-10.)

⚠ CAUTION

- Do not drive with the air cleaner removed; this will result in excessive engine wear.
- When removing the air cleaner filter, be careful that dust or dirt does not enter the air intake, or damage may result.
- Use parts for replacement from a professional workshop. Kia recommends to visit an authorised Kia dealer/service partner.

Climate control air filter

Filter inspection

The climate control air filter should be replaced according to the maintenance schedule. If the vehicle is operated in severely air-polluted cities or on dusty rough roads for a long period, it should be inspected more frequently and replaced earlier. When you replace the climate control air filter, replace it performing the following procedure, and be careful to avoid damaging other components.

1. Open the glove box and remove the stoppers on both sides.

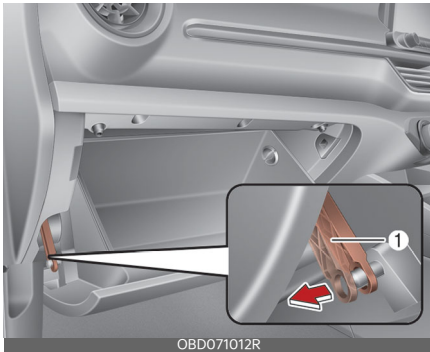

2. With the glove box open, pull the support strap (1).

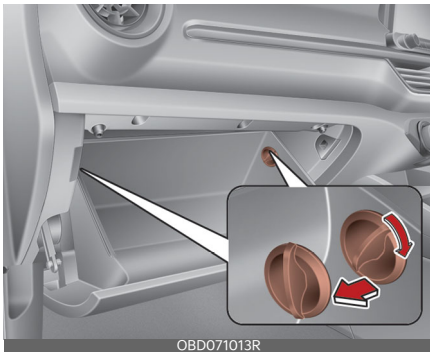

3. Remove the climate control air filter cover whilst pressing the lock on the left side of the cover.

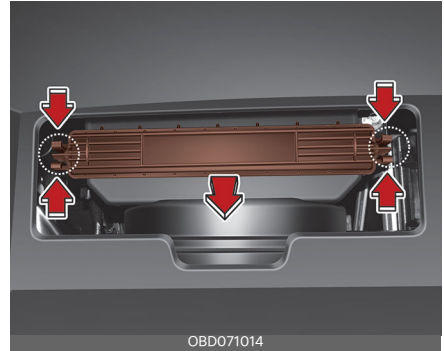

4. Replace the climate control air filter.



5. Reassemble in the reverse order of disassembly.

* NOTICE

When replacing the climate control air filter install it properly. Otherwise, the system may produce noise and the effectiveness of the filter may be reduced.

Wiper blades

Blade inspection

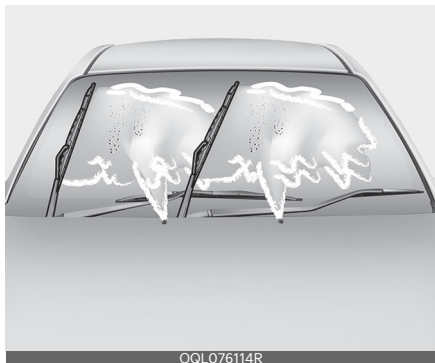

* NOTICE

Commercial hot waxes applied by automatic car washes have been known to make the windscreen difficult to clean. And it is the responsibility of customers to wash and manage the vehicle with adequate methods and materials.

Contamination of either the windscreen or the wiper blades with foreign matter can reduce the effectiveness of the windscreen wipers. Common sources of contamination are insects, tree sap, and hot wax treatments used by some commercial car washes. If the blades are not wiping properly, clean both the window and the blades with a good cleaner or mild detergent, and rinse thoroughly with clean water.

⚠ CAUTION

To prevent damage to the wiper blades, do not use petrol, kerosene, paint thinner, or other solvents on or near them.

Blade replacement

When the wipers no longer clean adequately, the blades may be worn or cracked, and require replacement.

⚠ CAUTION

To prevent damage to the wiper arms or other components, do not attempt to move the wipers manually.

⚠ CAUTION

The use of a non-specified wiper blade could result in wiper malfunction and failure.

Front windscreen wiper blade

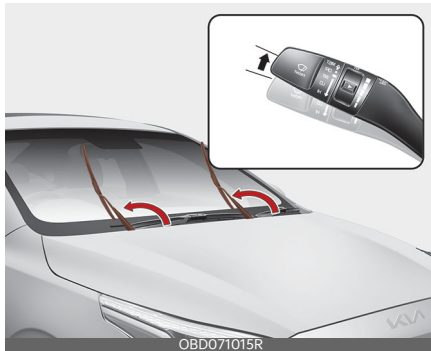

For your convenience, move the windscreen wiper blades to the service position as follows:

After turning off the engine, move the wiper switch to the single wiping (MIST) position within 20 seconds and hold the switch more than 2 seconds until the wiper blade is in the fully up position.

⚠ CAUTION

Do not allow the wiper arm to fall against the windscreen, since it may chip or crack the windscreen.

1. Raise the wiper arm.
2. Lift up the wiper blade clip (1). Then pull down the blade assembly (2) and remove it.

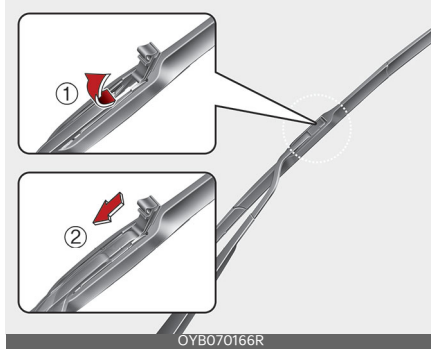

3. Install the new blade assembly.



4. Return the wiper arm on the wind-screen.
5. Turn ignition to the ON position and wiper arms will return to the normal operating position.

Type B

1. Raise the wiper arm and turn the wiper blade assembly to expose the plastic locking clip.

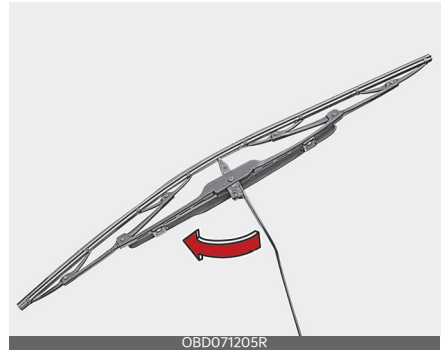

2. Compress the clip and slide the blade assembly downward.

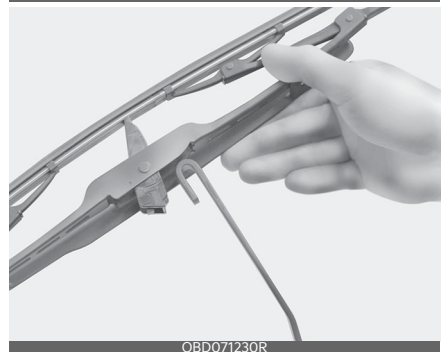
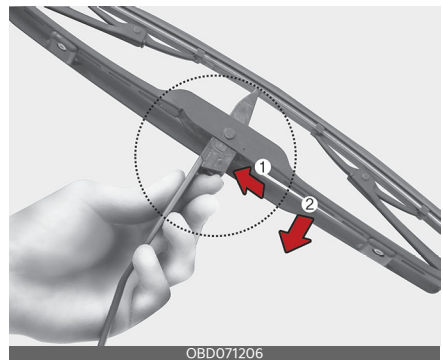

3. Lift it off the arm.
4. Install the new blade assembly.
5. Return the wiper arm on the wind-screen.

- Turn ignition to the ON position and wiper arms will return to the normal operating position.

Rear window wiper blade

- Raise the wiper arm and pull out the wiper blade assembly(1).

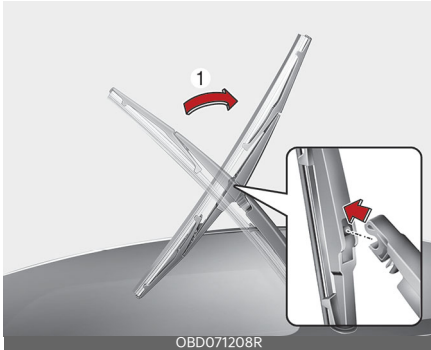

- Install the new blade assembly by inserting the centre part into the slot in the wiper arm until it clicks into place.

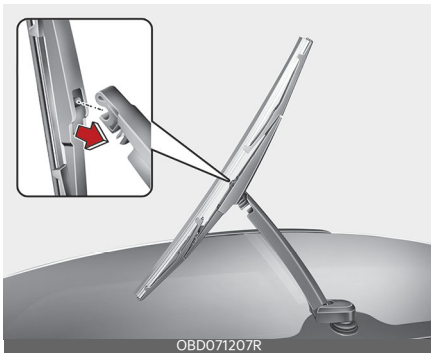

- Make sure the blade assembly is installed firmly by trying to pull it slightly. To prevent damage to the wiper arms or other components, have the wiper blade replaced by a professional workshop. Kia recommends to visit an authorised Kia dealer/service partner.

Battery

For best battery service

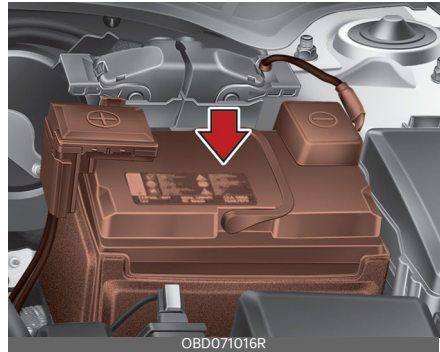

- Keep the battery securely mounted.
- Keep the battery top clean and dry.
- Keep the terminals and connections clean, tight, and coated with petroleum jelly or terminal grease.
- Rinse any spilled electrolyte from the battery immediately with a solution of water and baking soda.
- If the vehicle is not going to be used for an extended time, disconnect the battery cables.

* NOTICE

Basically equipped battery is maintenance free type. If your vehicle is equipped with the battery marked with LOWER and UPPER on the side, you can check the electrolyte level. The electrolyte level should be between LOWER and UPPER. If the electrolyte level is low, it needs to add distilled (demineralized) water (Never add sulfuric acid or other electrolyte). When refill, be careful not to splash the battery and adjacent components. And do not overfill the battery cells. It can cause corrosion on other parts. After then ensure that tighten the cell caps. Contact a professional work-

shop. Kia recommends to visit an authorised Kia dealer/service partner.

⚠ WARNING

Battery dangers



Always read the following instructions carefully when handling a battery.



Keep lighted cigarettes and all other flames or sparks away from the battery.



Hydrogen, a highly combustible gas, is always present in battery cells and may explode if ignited.



Keep batteries out of the reach of children because batteries contain highly corrosive SULFURIC

ACID. Do not allow battery acid to contact your skin, eyes, clothing or paint finish.



If any electrolyte gets into your eyes, flush your eyes with clean water for at least 15 minutes and get immediate medical attention. If electrolyte gets on your skin, thoroughly wash the contacted area.

If you feel pain or burning sensation, get medical attention immediately.



Wear eye protection when charging or working near a battery. Always provide ventilation when working in an enclosed space.



An inappropriately disposed battery can be harmful to the environment and human health. Dispose the battery according to your local law(s) or regulation.



The battery contains lead. Do not dispose of it after use. Contact a professional workshop. Kia recommends to

visit an authorised Kia dealer/service partner.

- When lifting a plastic-cased battery, excessive pressure on the case may cause battery acid to leak, resulting in personal injury. Lift with a battery carrier or with your hands on opposite corners.
- Never attempt to recharge the battery when the battery cables are connected.
- The electrical ignition system works with high voltage. Never touch these components with the engine running or the ignition switched on.

Failure to follow the above warnings can result in serious bodily injury or death.

⚠ CAUTION

- When you don't use the vehicle for a long time in the low temperature area, separate the battery and keep it indoors.
- Always charge the battery fully to prevent battery case damage in low temperature area.
- If you connect unauthorised electronic devices to the battery, the battery may be discharged. Never use unauthorised devices.

Battery capacity label

Example

AGM90L-DIN 90Ah(20HR) 170RC 12V					
850CCA(SAE) 680A(EN)					
OUM074113L					

* The actual battery label in the vehicle may differ from the illustration.

1. AGM90L-DIN : The Kia model name of battery
2. 90Ah(20HR) : The nominal capacity (in Ampere hours)
3. 170RC : The nominal reserve capacity (in min.)
4. 12V : The nominal voltage
5. 850CCA (SAE) : The cold-test current in amperes by SAE
6. 680A : The cold-test current in amperes by EN

Battery recharging

Your vehicle has a maintenance-free, calcium-based battery.

- If the battery becomes discharged in a short time (because, for example, the headlights or interior lights were left on whilst the vehicle was not in use), recharge it by slow charging (trickle) for 10 hours.
- If the battery gradually discharges because of high electric load whilst the vehicle is being used, recharge it at 20-30A for two hours.

WARNING

Recharging battery

When recharging the battery, observe the following precautions:

- The battery must be removed from the vehicle and placed in an area with good ventilation.
- Do not allow cigarettes, sparks, or flame near the battery.
- Watch the battery during charging, and stop or reduce the charging rate if the battery cells begin gassing (boiling) violently or if the temperature of the electrolyte of any cell exceeds 49°C (120°F).
- Wear eye protection when checking the battery during charging.

- Disconnect the battery charger in the following order.
 1. Turn off the battery charger main switch.
 2. Unhook the negative clamp from the negative battery terminal.
 3. Unhook the positive clamp from the positive battery terminal.

WARNING

- Before performing maintenance or recharging the battery, turn off all accessories and stop the engine.
- The negative battery cable must be removed first and installed last when the battery is disconnected.
- Operation related to the battery is recommended to be done by a professional workshop. Kia recommends to visit an authorised Kia dealer/service partner.

CAUTION

- Keep the battery away from water or any liquid.
- For your safety, use parts for replacement from a professional workshop. Kia recommends to visit an authorised Kia dealer/service partner.

CAUTION

AGM battery (if equipped)

- Absorbent Glass Mat (AGM) batteries are maintenance free and have the AGM battery serviced by a professional workshop. Kia recommends to visit an authorised Kia dealer/service partner.

For charging your AGM battery, use only fully automatic battery chargers

that are specially developed for AGM batteries.

- When replacing the AGM battery, use parts for replacement from a professional workshop. Kia recommends to visit an authorised Kia dealer/service partner.
- Do not open or remove the cap on top of the battery. This may cause leaks of internal electrolyte that could result in severe injury

Reset items

Items should be reset after the battery has been discharged or the battery has been disconnected.

- Auto up/down window
- Sunroof
- Trip computer
- Climate control system
- Integrated Memory System
- Audio

Tyres and wheels

Tyre care

For proper maintenance, safety, and maximum fuel economy, you must always maintain recommended tyre inflation pressures and stay within the load limits and weight distribution recommended for your vehicle.

Recommended cold tyre inflation pressures

All tyre pressures (including the spare) should be checked when the tyres are cold. "Cold Tyres" means the vehicle has not been driven for at least three hours or driven less than 1.6 km (one mile).

Recommended pressures must be maintained for the best ride, top vehicle handling, and minimum tyre wear.

For recommended inflation pressure, refer to "Tyres and wheels" on page 9-8.

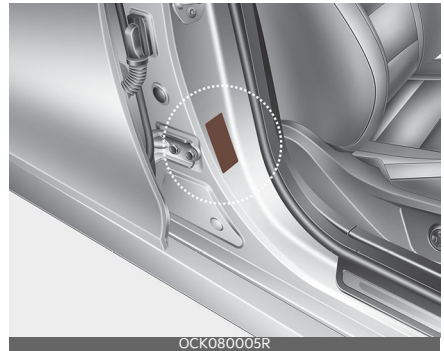

OCK080005R

All specifications (sizes and pressures) can be found on a label attached to the vehicle.

⚠ WARNING

Tyre underinflation

Severe underinflation (70 kPa (10 psi, 0.7 bar) or more) can lead to severe heat build-up, causing blowouts, tread separation and other tyre failures that can

result in the loss of vehicle control leading to severe injury or death. This risk is much higher on hot days and when driving for long periods at high speeds.

⚠ CAUTION

- Underinflation also results in excessive wear, poor handling and reduced fuel economy. Wheel deformation also is possible. Keep your tyre pressures at the proper levels. If a tyre frequently needs refilling, have the system checked by a professional workshop. Kia recommends to visit an authorised Kia dealer/service partner.
- Overinflation produces a harsh ride, excessive wear at the centre of the tyre tread, and a greater possibility of damage from road hazards.

⚠ CAUTION

- Warm tyres normally exceed recommended cold tyre pressures by 28 to 41 kPa (4 to 6 psi, 0.28 to 0.41 bar). Do not release air from warm tyres to adjust the pressure or the tyres will be underinflated.
- Be sure to reinstall the tyre inflation valve caps. Without the valve cap, dirt or moisture could get into the valve core and cause air leakage. If a valve cap is missing, install a new one as soon as possible.

⚠ WARNING

Tyre Inflation

Overinflation or underinflation can reduce tyre life, adversely affect vehicle handling, and lead to sudden tyre failure. This could result in loss of vehicle control and potential injury.

⚠ CAUTION

Tyre pressure

Always observe the following:

- Check tyre pressure when the tyres are cold. (After vehicle has been parked for at least three hours or hasn't been driven more than 1.6 km (one mile) since startup.)
- Check the pressure of your spare tyre each time you check the pressure of other tyres.
- Never overload your vehicle. Be careful not to overload a vehicle luggage rack if your vehicle is equipped with one.
- Worn, old tyres can cause accidents. If your tread is badly worn, or if your tyres have been damaged, replace them.

Checking tyre inflation pressure

Check your tyres once a month or more. Also, check the tyre pressure of the spare tyre.

How to check

Use a good quality gauge to check tyre pressure. You can not tell if your tyres are properly inflated simply by looking at them. Radial tyres may look properly inflated even when they're underinflated.

Check the tyre's inflation pressure when the tyres are cold. - "Cold" means your vehicle has been sitting for at least three hours or driven no WARNING - Tyre Inflation more than 1.6 km (1 mile).

Remove the valve cap from the tyre valve stem. Press the tyre gauge firmly onto the valve to get a pressure measurement. If the cold tyre inflation pressure matches the recommended

pressure on the tyre and loading information label, no further adjustment is necessary. If the pressure is low, add air until you reach the recommended amount.

If you overfill the tyre, release air by pushing on the metal stem in the centre of the tyre valve. Recheck the tyre pressure with the tyre gauge. Be sure to put the valve caps back on the valve stems. They help prevent leaks by keeping out dirt and moisture.

WARNING

- Inspect your tyres frequently for proper inflation as well as wear and damage. Always use a tyre pressure gauge.
- Tyres with too much or too little pressure wear unevenly causing poor handling, loss of vehicle control, and sudden tyre failure leading to accidents, injuries, and even death. The recommended cold tyre pressure for your vehicle can be found in this manual and on the tyre label located on the driver's side centre pillar.
- Worn tyres can cause accidents. Replace tyres that are worn, show uneven wear, or are damaged.
- Remember to check the pressure of your spare tyre. Kia recommends that you check the spare every time you check the pressure of the other tyres on your vehicle.

Tyre rotation

To equalize tread wear, it is recommended that the tyres be rotated every 10,000 km (6,500 miles) or sooner if irregular wear develops.

During rotation, check the tyres for correct balance.

When rotating tyres, check for uneven wear and damage. Abnormal wear is usually caused by incorrect tyre pressure, improper wheel alignment, out-of-balance wheels, severe braking or severe cornering. Look for bumps or bulges in the tread or side of tyre. Replace the tyre if you find either of these conditions. Replace the tyre if fabric or cord is visible. After rotation, be sure to bring the front and rear tyre pressures to specification and check lug nut tightness.

Refer to "Tyres and wheels" on page 9-8.

Without a spare tyre

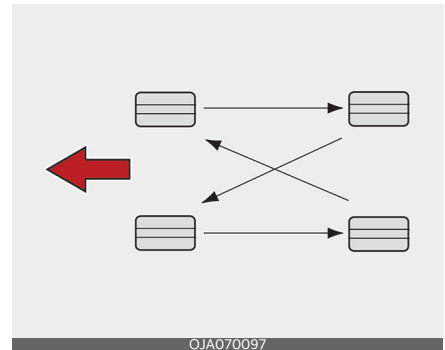

Directional tyres (if equipped)

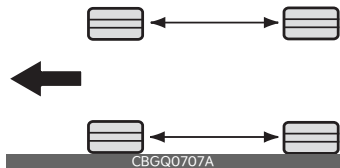

Disc brake pads should be inspected for wear whenever tyres are rotated.

*** NOTICE**

Rotate radial tyres that have an asymmetric tread pattern only from front to rear and not from right to left.

⚠ WARNING

- Do not use the compact spare tyre (if equipped) for tyre rotation.
- Do not mix bias ply and radial ply tyres under any circumstances. This may cause unusual handling characteristics that could result in death, severe injury, or property damage.

Wheel alignment and tyre balance

The wheels on your vehicle were aligned and balanced carefully at the factory to give you the longest tyre life and best overall performance.

In most cases, you will not need to have your wheels aligned again. However, if you notice unusual tyre wear or your vehicle pulling one way or the other, the alignment may need to be reset.

If you notice your vehicle vibrating when driving on a smooth road, your wheels may need to be rebalanced.

⚠ CAUTION

Improper wheel weights can damage your vehicle's aluminum wheels. Use only approved wheel weights.

Tyre replacement

If the tyre is worn evenly, a tread wear Indicator (A) will appear as a solid band across the tread. This shows there is less than 1.6 mm (1/16 in.) of tread left on the tyre. Replace the tyre when this happens.

Do not wait for the band to appear across the entire tread before replacing the tyre.

*** NOTICE**

We recommend that when replacing tyres, use the same originally supplied with the vehicles.

If not, that affects driving performance.

⚠ CAUTION

When replacing the tyres, recheck and tighten the wheel nuts after driving about 50km (31miles) and recheck after driving about 1,000km (620miles). If the steering wheel shakes or the vehicle vibrates whilst driving, the tyre is out-of-balance. Align the tyre balance. If the problem is not solved, contact a professional workshop. Kia recommends to visit an authorised Kia dealer/service partner.

⚠ WARNING**Replacing tyres**

To reduce the chance of serious or fatal injuries from an accident caused by tyre failure or loss of vehicle control:

- Replace tyres that are worn, show uneven wear, or are damaged. Worn tyres can cause loss of braking effectiveness, steering control, and traction.
- Do not drive your vehicle with too little or too much pressure in your tyres.

This can lead to uneven wear and tyre failure.

- When replacing tyres, never mix radial and bias-ply tyres on the same car. You must replace all tyres (including the spare) if moving from radial to bias-ply tyres.
- Using tyres and wheels other than the recommended sizes could cause unusual handling characteristics and poor vehicle control, resulting in a serious accident.
- Wheels that do not meet Kia's specifications may fit poorly and result in damage to the vehicle or unusual handling and poor vehicle control.
- The ABS works by comparing the speed of the wheels. The tyre size affects wheel speed. When replacing tyres, all 4 tyres must use the same size originally supplied with the vehicle. Using tyres of a different size can cause the ABS (Anti-lock Brake System) and ESC (Electronic Stability Control) to work irregularly.

Compact spare tyre replacement (if equipped)

A compact spare tyre has a shorter tread life than a regular size tyre. Replace it when you can see the tread wear indicator bars on the tyre. The replacement compact spare tyre should be the same size and design tyre as the one provided with your new vehicle and should be mounted on the same compact spare tyre wheel. The compact spare tyre is not designed to be mounted on a regular size wheel, and the compact spare tyre wheel is not designed for mounting a regular size tyre.

Wheel replacement

When replacing the metal wheels for any reason, make sure the new wheels are equivalent to the original factory units in diameter, rim width and offset.

WARNING

A wheel that is not the correct size may adversely affect wheel and bearing life, braking and stopping abilities, handling characteristics, ground clearance, body-to-tyre clearance, snow chain clearance, speedometer and odometer calibration, headlight aim and bumper height.

Tyre traction

Tyre traction can be reduced if you drive on worn tyres, tyres that are improperly inflated or on slippery road surfaces.

Tyres should be replaced when tread wear indicators appear. Slow down whenever there is rain, snow or ice on the road to reduce the possibility of losing control of the vehicle.

Tyre maintenance

In addition to proper inflation, correct wheel alignment helps to decrease tyre wear. If you find a tyre is worn unevenly, have a professional workshop check the wheel alignment. Kia recommends to visit an authorised Kia dealer/service partner.

When you have new tyres installed, make sure they are balanced. This will increase vehicle ride comfort and tyre life. Additionally, a tyre should always be rebalanced if it is removed from the wheel.

Tyre sidewall labeling

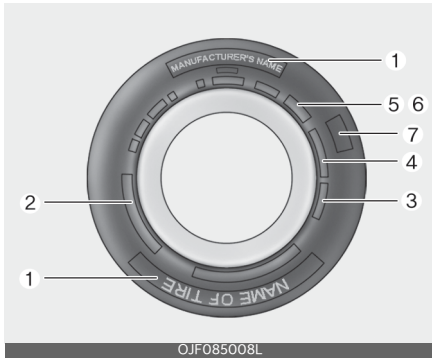

This information identifies and describes the fundamental characteristics of the tyre and also provides the tyre identification number (TIN) for safety standard certification. The TIN can be used to identify the tyre in case of a recall.

1. Manufacturer or brand name

Manufacturer or Brand name is shown.

2. Tyre size designation

A tyre's sidewall is marked with a tyre size designation. You will need this information when selecting replacement tyres for your vehicle. The following explains what the letters and numbers in the tyre size designation mean.

Example tyre size designation:

(These numbers are provided as an example only; your tyre size designator could vary depending on your vehicle.)

P235/55R19 108T

P - Applicable vehicle type (tyres marked with the prefix "P" are intended for use on passenger vehicles or light trucks; however, not all tyres have this marking).

235 - Tyre width in millimeters.

55 - Aspect ratio. The tyre's section height as a percentage of its width.

R - Tyre construction code (Radial).

19 - Rim diameter in inches.

108 - Load Index, a numerical code associated with the maximum load the tyre can carry.

T - Speed Rating Symbol. See the speed rating chart in this section for additional information.

Wheel size designation

Wheels are also marked with important information that you need if you ever have to replace one. The following explains what the letters and numbers in the wheel size designation mean.

Example wheel size designation:

7.5JX19

7.5 - Rim width in inches.

J - Rim contour designation.

19 - Rim diameter in inches.

Tyre speed ratings

The chart below lists many of the different speed ratings currently being used for passenger car tyres. The speed rating is part of the tyre size designation on the sidewall of the tyre. This symbol corresponds to that tyre's designed maximum safe operating speed.

Speed Rating Symbol	Maximum Speed
S	180 km/h (112 mph)
T	190 km/h (118 mph)
H	210 km/h (130 mph)
V	240 km/h (149 mph)
W	270 km/h (168 mph)

Speed Rating Symbol	Maximum Speed
Y	300 km/h (186 mph)
Z	Above 240 km/h (149 mph)

3. Checking tyre life (TIN : Tyre Identification Number)

Any tyres that are over 6 years old, based on the manufacturing date, (including the spare tyre) should be replaced by new ones. You can find the manufacturing date on the tyre sidewall (possibly on the inside of the wheel), displaying the DOT Code. The DOT Code is a series of numbers on a tyre consisting of numbers and English letters. The manufacturing date is designated by the last four digits (characters) of the DOT code.

DOT : XXXX XXXX OOOO

The front part of the DOT means a plant code number, tyre size and tread pattern and the last four numbers indicate week and year manufactured.

For example:

DOT XXXX XXXX 1622 represents that the tyre was produced in the 16th week of 2022.

WARNING

Tyre age

Tyres degrade over time, even when they are not being used.

Regardless of the remaining tread, we recommend that tyres be replaced after approximately six (6) years of normal service. Heat caused by hot climates or frequent high loading conditions can accelerate the aging process. Failure to follow this warning can result in sudden

tyre failure, which could lead to a loss of control and an accident involving serious injury or death.

4. Tyre ply composition and material

The number of layers or plies of rubber-coated fabric in the tyre. Tyre manufacturers also must indicate the materials in the tyre, which include steel, nylon, polyester, and others. The letter "R" means radial ply construction; the letter "D" means diagonal or bias ply construction; and the letter "B" means belted-bias ply construction.

5. Maximum permissible inflation pressure

This number is the greatest amount of air pressure that should be put in the tyre. Do not exceed the maximum permissible inflation pressure. Refer to the Tyre and Loading Information label for recommended inflation pressure.

6. Maximum load rating

This number indicates the maximum load in kilograms and pounds that can be carried by the tyre. When replacing the tyres on the vehicle, always use a tyre that has the same load rating as the factory installed tyre.

7. Uniform tyre quality grading

Quality grades can be found where applicable on the tyre sidewall between tread shoulder and maximum section width.

For example:

TREADWEAR 200

TRACTION AA TEMPERATURE A

Tread wear

The tread wear grade is a comparative rating based on the wear rate of the tyre when tested under controlled conditions on a specified government test course. For example, a tyre graded 150 would wear one-and-a-half times (1½) as well on the government course as a tyre graded 100.

The relative performance of tyres depends upon the actual conditions of their use, however, and may depart significantly from the norm due to variations in driving habits, service practices and differences in road characteristics and climate.

These grades are molded on the sidewalls of passenger vehicle tyres. The tyres available as standard or optional equipment on your vehicle may vary with respect to grade.

Traction - AA, A, B & C

The traction grades, from highest to lowest, are AA, A, B and C. Those grades represent the tyre's ability to stop on wet pavement as measured under controlled conditions on specified government test surfaces of asphalt and concrete. A tyre marked C may have poor traction performance.

Temperature -A, B & C

The temperature grades are A (the highest), B, and C, representing the tyre's resistance to the generation of heat and its ability to dissipate heat when tested under controlled conditions on a specified indoor laboratory test wheel.

Sustained high temperature can cause the material of the tyre to degenerate and reduce tyre life, and excessive temperature can lead to sudden tyre failure. Grades B and A represent higher levels of performance on the laboratory test wheel than the minimum required by law.

WARNING

The traction grade assigned to this tyre is based on straightahead braking traction tests, and does not include acceleration, cornering, hydroplaning, or peak traction characteristics.

WARNING

Tyre temperature

The temperature grade for this tyre is established for a tyre that is properly inflated and not overloaded. Excessive speed, underinflation, or excessive loading, either separately or in combination, can cause heat build-up and possible sudden tyre failure. This can cause loss of vehicle control and serious injury or death.

Low aspect ratio tyre (if equipped)

Low aspect ratio tyres, whose aspect ratio is lower than 50, are provided for sporty looks.

Because the low aspect ratio tyres are optimized for handling and braking, it may be more uncomfortable to ride in and there is more noise compare with normal tyres.

CAUTION

Because the sidewall of the low aspect ratio tyre is shorter than the normal, the wheel and tyre of the low aspect ratio

tyre is easier to be damaged. So, follow the instructions below.

- When driving on a rough road or off road, drive cautiously because tyres and wheels may be damaged. And after driving, inspect tyres and wheels.
- When passing over a pothole, speed bump, manhole, or kerb stone, drive slowly so that the tyres and wheels are not damaged.
- If the tyre is impacted, inspect the tyre condition or contact a professional workshop. Kia recommends to visit an authorised Kia dealer/service partner.
- To prevent damage to the tyre, inspect the tyre condition and pressure every 3,000 km (1,900 miles).

⚠ CAUTION

- It is not easy to recognize the tyre damage with your own eyes. But if there is the slightest hint of tyre damage, even though you cannot see the tyre damage with your own eyes, have the tyre checked or replaced because the tyre damage may cause air leakage from the tyre.
- If the tyre is damaged by driving on a rough road, off road, pothole, manhole, or kerb stone, it will not be covered by the warranty.
- You can find out the tyre information on the tyre sidewall.

Fuses

Blade type / Cartridge type / Multi fuse / Fusible link

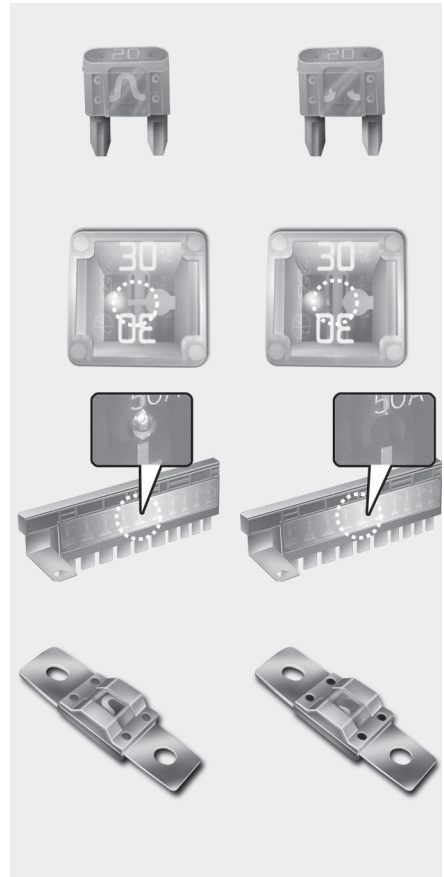

* Left side : Normal

Right side : Blown

A vehicle's electrical system is protected from electrical overload damage by fuses.

This vehicle has 4 (or 5) fuse panels, one located in the driver's side panel bolster, the others in the engine compartment near the battery.

If any of your vehicle's lights, accessories, or controls do not work, check the appropriate circuit fuse. If a fuse has blown, the element inside the fuse will melt.

If the electrical system does not work, first check the driver's side fuse panel. Before replacing a blown fuse, disconnect the negative battery cable.

Always replace a blown fuse with one of the same rating.

If the replacement fuse blows, this indicates an electrical problem. Avoid using the system involved and immediately consult a professional workshop. Kia recommends to consult an authorised Kia dealer/service partner.

Three kinds of fuses are used: blade type for lower amperage rating, cartridge type, and multi fuse for higher amperage ratings.

WARNING

Fuse replacement

- Never replace a fuse with anything but another fuse of the same rating.
- A higher capacity fuse could cause damage and possibly a fire.
- Never install a wire or aluminum foil instead of the proper fuse even as a temporary repair. It may cause extensive wiring damage and a possible fire.
- Do not arbitrarily modify or add-on electric wiring of the vehicle.

CAUTION

Do not use a screwdriver or any other metal object to remove fuses because it may cause a short circuit and damage the system.

NOTICE

- When replacing fuse, turn the ignition "OFF" and turn off switches of all electrical devices then remove battery (-) terminal.
- The actual fuse/relay panel label may differ from equipped items.

CAUTION

- When replacing a blown fuse or relay with a new one, make sure the new fuse or relay fits tightly into the clips. The incomplete fastening fuse or relay may cause the vehicle wiring and electric systems damage and a possible fire.
- Do not remove fuses, relays and terminals fastened with bolts or nuts. The fuses, relays and terminals may be fastened incompletely, and it may cause a possible fire. If fuses, relays and terminals fastened with bolts or nuts are blown, consult a professional workshop. Kia recommends to consult an authorised Kia dealer/service partner.
- Do not input any other objects except fuses or relays into fuse/relay terminals such as a driver or wiring. It may cause contact failure and system malfunction.
- Do not plug in screwdrivers or after-market wiring into the terminal originally designed for fuse and relays only. The electrical system and wiring of the vehicle interior may be damaged or burned due to contact failure.
- If you directly connect the wire on the taillight or replace the bulb which is over the regulated capacity to install

trailers etc., the inner junction block can get burned.

⚠ CAUTION

Visually inspect the battery cap to ensure it is securely closed. If the battery cap is not securely closed, moisture may enter the system and damage the electrical components.

* NOTICE

Random wiring prohibited when retrofitting equipment

Use of random wiring in the vehicle might cause danger due to failure and damage of the vehicle's performance.

Using random wires especially when retrofitting infotainment or theft alarm system, remote engine control, car phone or radio might damage the vehicle or cause fire.

* NOTICE

Remodeling Prohibited

Do not try remodeling the vehicle in any way. It is illegal, and may affect the vehicle's performance, durability, and safety. Warranty is also not provided for problems caused by remodeling.

Be aware of safety problems caused by remodeling the vehicle with unauthorised electrical devices (lamp, black box, electrical equipment, diagnostic device, communication device, etc.). It might cause malfunction of the vehicle, wiring damage, battery discharge, connector damage, or fire. the vehicle or cause fire.

* NOTICE

Window tinting precaution

Window tint (especially metallic film) might cause communication disorder or poor radio reception, and malfunction of the automatic lighting system due to excessive change of illumination inside the vehicle. The solution used might also flow into electric, electronic devices causing disorder and failure.

Inner panel fuse replacement

1. Turn the ignition switch and all other switches off.
2. Open the fuse panel cover.



If the switch is located in the "OFF", caution will be displayed in the cluster.

3. Pull the suspected fuse straight out. Use the removal tool provided in the main fuse box in the engine compartment.

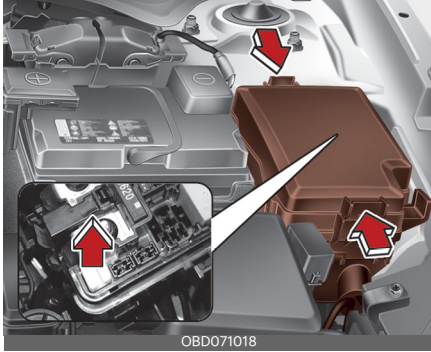

4. Check the removed fuse; replace it if it is blown.

Spare fuses are provided in the instrument panel fuse panel (or in the engine compartment fuse panel).

5. Push in a new fuse of the same rating, and make sure it fits tightly in the clips.

If it fits loosely, consult a professional workshop. Kia recommends to consult an authorised Kia dealer/service partner.

If you do not have a spare, use a fuse of the same rating from a circuit you may not need for operating the vehicle, such as the cigarette lighter fuse.

If the headlights or taillights, stoplights, courtesy lamp, day time running lights (D.R.L) do not work and the fuses are OK, check the fuse panel in the engine compartment. If a fuse is blown, it must be replaced.

Engine compartment fuse replacement

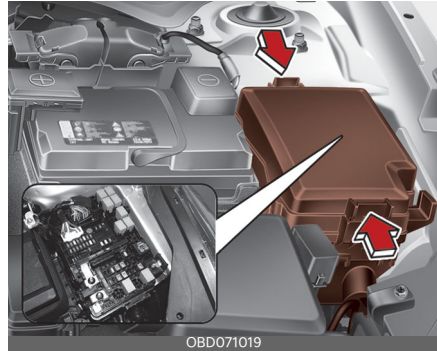

1. Turn the ignition switch and all other switches off.
2. Remove the fuse panel cover by pressing the tab and pulling the cover up. When the blade type fuse is disconnected, remove it by using the clip designed for changing fuses located in the engine room fuse box. Upon removal, securely insert reserve fuse of equal quantity.
3. Check the removed fuse; replace it if it is blown. To remove or insert the fuse, use the fuse puller in the engine compartment fuse panel.
4. Push in a new fuse of the same rating, and make sure it fits tightly in the clips. If it fits loosely, consult a professional workshop. Kia recommends to consult an authorised Kia dealer/service partner.

⚠ CAUTION

After checking the fuse panel in the engine compartment, securely install the fuse panel. If not, cover through the audible clicking sound. Electrical failures may occur from water contact.

Multi fuse

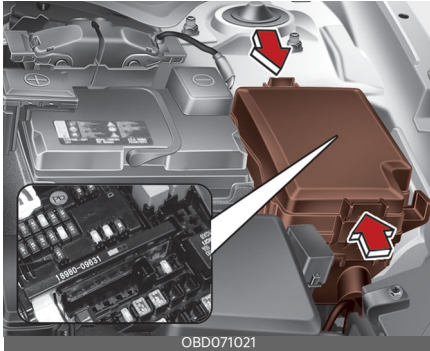

If the multi fuse is blown, it must be removed as follows:

1. Disconnect the negative battery cable.
2. Remove the nuts shown in the picture above.
3. Replace the fuse with a new one of the same rating.
4. Reinstall in the reverse order of removal.

* NOTICE

If the multi fuse is blown, consult a professional workshop. Kia recommends to consult an authorised Kia dealer/service partner.

Main fuse

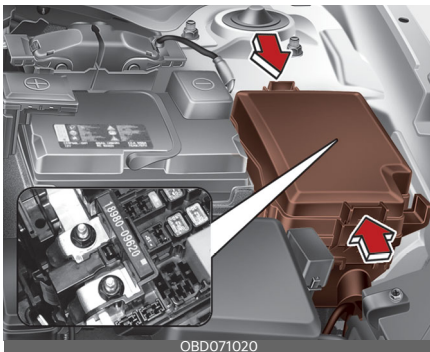

If the main fuse is blown, it must be removed as follows:

1. Turn off the engine.
2. Disconnect the negative battery cable.
3. Remove the nuts shown in the picture above.
4. Replace the fuse with a new one of the same rating.
5. Reinstall in the reverse order of removal

If the main fuse is blown, even though the engine compartment panel fuse and inner fuse are not blown, if the electrical system is not operated, the main fuse may be blown. The main fuse is connected with other parts and system. Contact a professional workshop. Kia recommends to visit an authorised Kia dealer/service partner.

Battery fuse

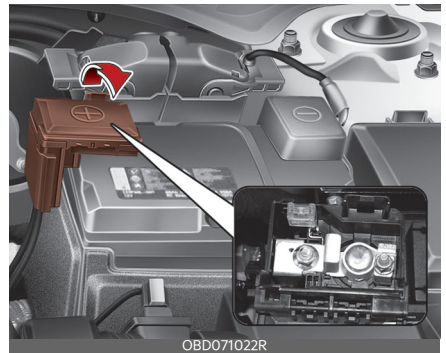

If the battery fuse is blown, it must be removed as follows:

1. Disconnect the negative battery cable.
2. Remove the nuts shown in the picture above.
3. Replace the fuse with a new one of the same rating.
4. Reinstall in the reverse order of removal.

*** NOTICE**

If the battery fuse is blown, consult a professional workshop. Kia recommends to consult an authorised Kia dealer/service partner.

⚠ CAUTION

Visually inspect the battery cap for secure closing. If the battery cap is not securely latched, the electrical system may be damaged to due influx of moisture into the system.

Fuse/relay panel description

Driver's side fuse panel



Engine compartment fuse panel

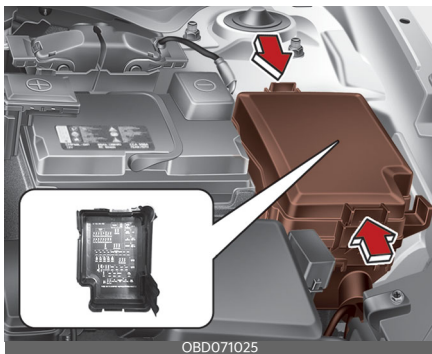

Engine compartment fuse panel (Battery terminal cover)

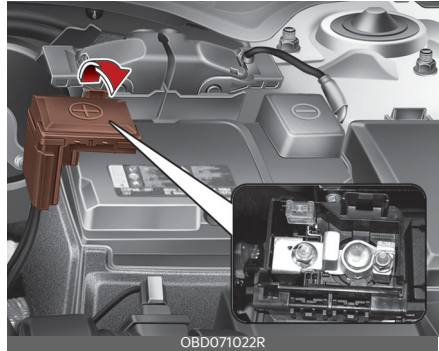

























Inside the fuse/relay panel covers, you can find the fuse/relay label describing fuse/relay name and capacity.

*** NOTICE**

Not all fuse panel descriptions in this manual may be applicable to your vehicle. It is accurate at the time of printing. When you inspect the fuse panel in your vehicle, refer to the fuse panel label.

Instrument panel (Driver's side fuse panel)

Fuse Name	Symbol	Fuse rating	Circuit Protected
MULTIMEDIA		15A	Audio, Audio/Video & Navigation Head Unit
E-CALL		10A	E-Call Module
MEMORY1	¹ 	10A	Driver IMS (Integrated memory system) Module, Air Conditioner Control Module, Instrument Cluster, Auto Light & Photo Sensor
DOOR LOCK		20A	Door Lock/Unlock Relay
P/WDW RH	^{RH} 	25A	Power Window Right Handle side Relay, Driver Safety Power Window Module
WASHER		15A	Multifunction Switch
MODULE 7	⁷ 	7.5A	Rear Seat Warmer Control Module, Front Seat Warmer Control Module, Front Air Ventilation Seat Control Module, Electric Sound Generator Unit
REAR WIPER		15A	Rear Wiper Motor, ICM (Integrated Circuit Module), Relay BOX (RR Wiper Relay)
P/WDW LH	^{LH} 	25A	Power Window Left Handle side Relay
A/C1	¹ 	7.5A	Engine Room Junction Block (BLOWER Relay, PTC HEATER 1 Relay), Air Conditioner Control Module
MODULE 6	⁶ 	7.5A	IBU (Integrated Body Control Unit)
S/HEAT-ERRR	^{RR} 	15A	Rear Seat Warmer Control Module
SUNROOF1	¹ 	15A	Sunroof Motor
P/SEAT-DRV	^{DRV} 	25A	Driver IMS (Integrated memory system) Module, Driver Seat Manual Switch
AMP		25A	AMP (Amplifier)
AIR BAG1	¹ 	15A	SRS (Supplemental Restraint System) Control Module
HEATED-MIRROR		10A	Driver/Passenger Power Outside Mirror, Air Conditioner Control Module, ECM (Engine Control Module)/PCM (Power train Control Module)
A/C3	³ 	10A	Compressor (Smartstream G1.6)











Fuse Name	Symbol	Fuse rating	Circuit Protected
MODULE 1	¹ MODULE	10A	Key Interlock Switch, Multipurpose Check Connector, Data Link Connector, ICM (Integrated Circuit Module) Relay Box (Outside Mirror Folding/Unfolding Relay), Hazard Switch, Driver/Passenger Smart Key Outside Handle, Mood Lamp Control Unit
TRUNK		10A	Trunk Relay
S/HEATER-FRT	^{FRT} 	20A	Front Seat Warmer Control Module, Front Air Ventilation Seat Control Module
MDPS	 ¹	7.5A	MDPS (Motor Driven Power Steering) Unit
MODULE4	⁴ MODULE	7.5A	Lane Keeping Assist Unit, IBU (Integrated Body Control Unit), Forward Collision Avoidance Assist Unit, EPB switch
MODULE 5	⁵ MODULE	10A	MTS (Mozen Telematics System) E-Call Module, Crash Pad Switch, Electro Chromic Mirror, Audio/Video & Navigation Head Unit, Audio, Air Conditioner Control Module, Rear Seat Warmer Control Module, Front Seat Warmer Control Module, Front Air Ventilation Seat Control Module, Driver IMS (Integrated memory system) Module, Head Lamp Left Handle side/Right Handle side, Auto Transmission Shift Lever Indicator, Multipurpose Check Connector, Data Link Connector
AIR BAG2	² 	10A	SRS (Supplemental Restraint System) Control Module
BRAKESWITCH	BRAKE SWITCH	10A	IBU (Integrated Body Control Unit), Stop Lamp Switch
AIR BAG-IND	^{IND} 	7.5A	Instrument Cluster, Air Conditioner Control Module
IG1	IG1	25A	Engine Room Junction Block (Fuse - ABS3, ECU5, TCU2, SENEOR4)
IBU1	¹ IBU	15A	IBU (Integrated Body Control Unit)
CLUSTER	CLUSTER	7.5A	Instrument Cluster
IBU2	² IBU	7.5A	IBU (Integrated Body Control Unit)
WIPER	^{LOH} 	10A	Engine Room Junction Block (Front Wiper (Low) Relay), Front Wiper Motor, ECM (Engine Control Module)/PCM (Power train Control Module), IBU (Integrated Body Control Unit)







Fuse Name	Symbol	Fuse rating	Circuit Protected
MODULE3	³ MODULE	7.5A	Sport Mode Switch, Stop Lamp Switch
A/C2	² A/C	10A	Engine Room Junction Block (BLOWER Relay), Air Conditioner Control Module, Blower Resistor, Blower Motor, ECM (Engine Control Module)/PCM (Power train Control Module)
START		7.5A	Transaxle Range Switch, Engine Room Junction Block (PDM 3 (IG1) Relay), IBU (Integrated Body Control Unit), ECM (Engine Control Module), PCM (Power train Control Module), Position switch
MODULE 2	² MODULE	10A	Audio, Audio/Video & Navigation Head Unit, IBU (Integrated Body Control Unit), MTS (Mozen Telematics System) E-Call Module, Rear USB Charger, Wireless Charger, EPB switch







Engine compartment fuse panel (Battery terminal cover)







Engine room compartment fuse panel











Fuse Name	Symbol	Fuse rating	Circuit Protected
ALTERNATOR	ALT	150/ 180/ 200A	Fuse : BURGLAR ALARM, ABS1, ABS2, DCU1, POWER OUTLET1, Alternator
MDPS 1	 ¹	80A	MDPS (Motor Driven Power Steering) Unit
BATTERY 5	⁵ 	60A	Fuse : ECU3, A/CON, ECU4, WIPER, HORN, Engine Control Relay
BATTERY 2	² 	60A	Instrument Panel Junction Block
BATTERY 3	³ 	60A	Instrument Panel Junction Block
BATTERY 4	⁴ 	50A	Instrument Panel Junction Block (Fuse :TRUNK, POWER WINDOW RH, POWER WINDOWLH, POWER SEAT DRIVER, SEAT HEATER FRONT, AMP, SUN-ROOF1)
COOLING FAN 1	¹ 	60A	COOLING FAN 1 Relay
REAR HEATED		40A	REAR HEATED Relay
BLOWER		40A	BLOWER Relay
IG1	IG1	40A	Ignition Switch, PDM 3 (IG1) Relay, PDM 2 (ACC) Relay
IG2	IG2	40A	Ignition Switch, START Relay, PDM 4 (IG2) Relay
VACUUM PUMP	VACUUM PUMP	20A	Vacuum pump
EPB 1	¹ 	60A	EPB (Electronic Parking Brake)
PTC HEATER	PTC HEATER	50A	PTC HEATER Relay
EPB 2	² 	40A	EPB (Electronic Parking Brake)
POWER-OUTLET 3	³ POWER OUTLET	20A	Front Power Outlet
POWER-OUTLET 2	² POWER OUTLET	20A	Front Power Outlet
TCU 1	^{T1} 	15A	TCM (Transmission Control Module)

Fuse Name	Symbol	Fuse rating	Circuit Protected
FUEL PUMP	FUEL PUMP	20A	FUEL PUMP Relay
COOLING FAN 2	² 	30A	COOLING FAN 3 Relay, COOLING FAN 2 Relay
BATTERY 1	¹ 	40A	Instrument Panel Junction Block (LONG TERM LOAD LATCH RELAY, Fuse : MODULE1,SEAT HEATER REAR, DOOR LOCK, IBU1, BRAKE SWITCH, AIR BAG2)
DCT 1	⁴ DCU	40A	TCM (Transmission Control Module)
DCT 2	³ DCU	40A	TCM (Transmission Control Module)
BUR-GLARALAR M		10A	ICM Relay Box (Burglar Alarm Relay)
ABS 1	¹ 	40A	ABS (Anti-lock brake system) Control Module, ESC (Electronic Stability Control) Control Module
ABS 2	² 	30A	ABS (Anti-lock brake system) Control Module, ESC (Electronic Stability Control) Control Module
POWER-OUTLET 1	¹ POWER OUTLET	40A	POWER OUTLET Relay
SENSOR 2	^{S2} 	10A	[(Petrol) 1.6 MPI, (Petrol) 2.0 MPI] Purge Control Solenoid Valve, Variable Intake Solenoid Valve, COOLING FAN 3 Relay, COOLING FAN 2 Relay, Oil Control Valve #1/#2, A/CON Relay, CCV, Air Flow Sensor, OCV #3 [(Petrol) 1.6 T-GDi] Oil Control Valve #1/#2, CCV, Cooling Fan 1 Relay, PCSV, RCV [Smartstream G 1.6] Oil Control Valve #1/#2, CCV, Variable Intake Solenoid Valve, Purge Control Solenoid Valve, COOLING FAN 3 Relay, COOLING FAN 2 Relay
ECU 2	^{E2} 	10A	[(Petrol) 1.6 MPI] ECM (Engine Control Module)/PCM (Power train Control Module) [(Petrol) 1.6 T-GDi] ECM (Engine Control Module) [(Petrol) 2.0 MPI] PCM (Power train Control Module) [Smartstream G 1.6] PCM (Powertrain Control Module)

Fuse Name	Symbol	Fuse rating	Circuit Protected
ECU 1	E1 	20A	[(Petrol) 1.6 MPI] ECM (Engine Control Module)/PCM (Power train Control Module) [(Petrol) 1.6 T-GDi] ECM (Engine Control Module) [(Petrol) 2.0 MPI] PCM (Power train Control Module) [Smartstream G 1.6] PCM (Powertrain Control Module)
INJECTOR	INJECTOR	15A	[(Petrol) 1.6 MPI, (Petrol) 2.0 MPI] INJECTOR #1~#4 [Smartstream G 1.6] INJECTOR #1~#8
SENSOR 1	S1 	15A	[(Petrol) 1.6 MPI] Oxygen Sensor (UP/Down) [(Petrol) 1.6 T-GDi] Oxygen Sensor (UP/Down) [(Petrol) 2.0 MPI] Oxygen Sensor (UP/Down) [Smartstream G 1.6] Oxygen Sensor (UP/Down)
IGNITION COIL	IGN COIL	20A	[(Petrol) 1.6 MPI] Ignition Coil #1~#4, Condenser [(Petrol) 1.6 T-GDI, (Petrol) 2.0 MPI] Ignition Coil #1~#4 [Smartstream G 1.6] Ignition Coil #1~#4
ECU 3	E3 	15A	[(Petrol) 1.6 MPI] ECM (Engine Control Module)/PCM (Power train Control Module) [(Petrol) 1.6 T-GDi] ECM (Engine Control Module) [(Petrol engine) 2.0 MPI] PCM (Power train Control Module) [Smartstream G 1.6] PCM (Powertrain Control Module)
AIRCONDITIONER	A/C	10A	Air Conditioner Relay
ECU 5	E5 	10A	[(Petrol) 1.6 MPI] ECM (Engine Control Module)/PCM (Power train Control Module) [(Petrol) 1.6 T-GDi] ECM (Engine Control Module) [(Petrol) 2.0 MPI] PCM (Power train Control Module) [Smartstream G 1.6] PCM (Powertrain Control Module)
SENSOR 4	S4 	15A	[(Petrol) 1.6 T-GDi] Electric Vacuum Pump
ABS 3	3 (ABS) 	10A	ABS (Anti-lock brake system)/ESC (Electronic Stability Control) Control Module
TCU 2	T2 	15A	[(Petrol) 1.6 MPI, (Petrol) 2.0 MPI] Transaxle Range Switch [Smartstream G 1.6] Transaxle Range Switch [(Petrol) 1.6 T-GDI] Transaxle Range Switch, TCM(Transmission Control Module)

Fuse Name	Symbol	Fuse rating	Circuit Protected
SENSOR 3		10A	FUEL PUMP Relay
ECU 4		15A	[(Petrol) 1.6 MPI] ECM (Engine Control Module)/PCM (Power train Control Module) [(Petrol) 1.6 T-GDi] ECM (Engine Control Module) [(Petrol) 2.0 MPI] PCM (Power train Control Module) [Smartstream G 1.6] PCM (Powertrain Control Module)
WIPER		25A	Wiper Relay
HORN		15A	Horn Relay

Relay

Relay Name	Symbol	Type
COOLING FAN 3 Relay	³ 	MICRO
COOLING FAN 2 Relay	² 	MICRO
PDM 3 (IG1) Relay	³ (IG1) 	MICRO
START Relay	¹ 	MICRO
PDM 4 (IG2) Relay	⁴ (IG2) 	MICRO
FUEL PUMP Relay	FUEL PUMP	MICRO
PDM 2 (ACC) Relay	² (ACC) 	MICRO
COOLING FAN 1 Relay	¹ 	MINI
BLOWER Relay		MINI
PTC HEATER Relay	PTC HEATER 	MICRO
REAR HEATED Relay		MICRO
POWER OUTLET Relay	POWER OUTLET 	MICRO

Light bulbs

Bulb replacement precaution

Please prepare bulbs with appropriate standards in case of emergencies. Refer to "Bulb wattage" on page 9-7.

When changing bulbs and sorts, first turn off the engine at a safe place, firmly apply the side brake and take out the battery's negative (-) terminal.

WARNING

Working on the lights

Prior to working on the light, firmly apply the parking brake, ensure that the ignition switch is turned to the LOCK position and turn off the lights to avoid sudden movement of the vehicle and burning your fingers or receiving an electric shock.

Use only the bulbs of the specified wattage.

WARNING

Be sure to replace the burnedout bulb with one of the same wattage rating. Otherwise, it may cause extensive wiring damage and possible fire.

CAUTION

If you don't have necessary tools, the correct bulbs and the expertise, consult a professional workshop. Kia recommends to consult an authorised Kia dealer/service partner.

In many cases, it is difficult to replace vehicle light bulbs because other parts of the vehicle must be removed before you can get to the bulb. This is especially true if you have to remove the headlight assembly to get to the bulb(s). Remov-

ing/ installing the headlight assembly can result in damage to the vehicle.

CAUTION

- If unauthentic parts or substandard lights are used when changing lights, it may lead to fuse disconnection and malfunction, and other wiring damages.
- Do not install extra lamps or LED to the vehicle. If supplementary lights are installed, it may lead to lamp malfunction and flickering of the lights. In addition, the fuse box and other wiring may be damaged.

• Lamp part malfunction due to network failure

The headlamp, taillight, and fog light may lit up when the head lamp switch is turned ON, and not light up when the taillight or fog light switch is turned ON. This may be caused by network failure or vehicle electrical control system malfunction. If there is a problem, have the system serviced by a professional workshop. Kia recommends to visit an authorised Kia dealer/service partner.

• Lamp part malfunction due to electrical control system stabilization

A normally functioning lamp may flicker momentarily. This momentary occurrence is due to stabilization of the vehicle's electrical control system. If the lamp soon returns to normal, the vehicle does not require service.

However, if the lamp goes out after the momentary flickering, or the flickering continues, have the system serviced by a professional workshop. Kia recommends to visit an authorised Kia dealer/service partner.

*** NOTICE**

- If the light bulb or lamp connector is removed from an operating lamp activated by electricity, the fuse box's electronic device may scan it as a malfunction. Therefore, a lamp malfunction history may be recorded in Diagnostic Trouble Code (DTC) in the fuse box.
- It is normal for an operating lamp may blink temporarily. Since this occurrence is due stabilization function of the vehicle's electronic control device, if the lamp lights up normally after temporary blinking, there is no problem in the vehicle.

However, if the lamp continues to blink several times or turn off completely, there may be an error in the vehicle's electronic control device. In this case, have the vehicle checked by a professional workshop immediately. Kia recommends to visit an authorised Kia dealer/service partner.

*** NOTICE**

After an accident or after the headlight assembly is reinstalled, have the headlight aiming adjusted by a professional workshop. Kia recommends to visit an authorised Kia dealer/service partner.

*** NOTICE**

You can find moisture inside the lens of lamps after a car wash or driving in the rain. It is a natural event caused by the temperature difference between the inside and the outside of the lamp and does not mean a problem with its functions. The moisture inside the lamp would disappear if you drive the vehicle with the headlamp turned on, however,

the level at which the moisture is removed may differ depending on the size / location / condition of the lamp. If the moisture continues to stay inside the lamp, have the vehicle checked by a professional workshop immediately. Kia recommends to visit an authorised Kia dealer/service partner.

Light bulb position (Front)

Head lamp - Type A

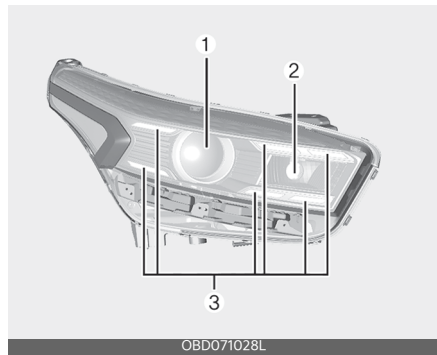

Head lamp - Type B

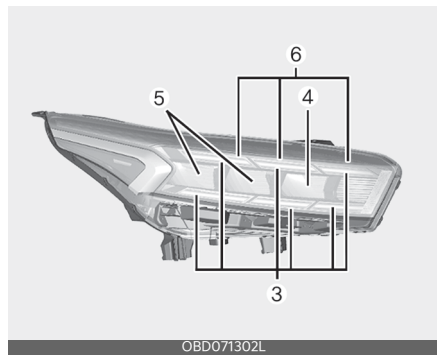

Fog lamp

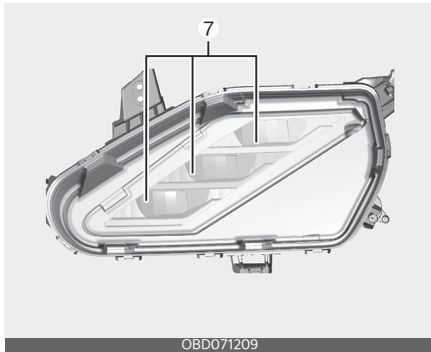

Rear combination lamp - 4door Type B

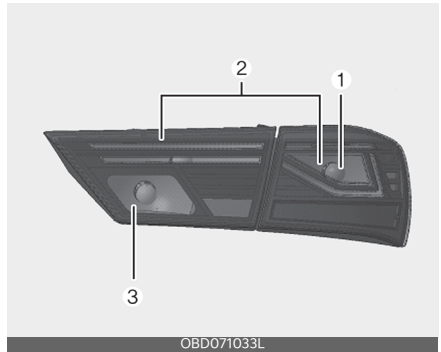

- 1. Headlamp (High/Low) (Bulb type)
- 2. Front turn signal lamp (Bulb type)
- 3. Position lamp / Day time running lamp (LED type)
- 4. Headlamp (High) (LED type)
- 5. Headlamp (Low) (LED type)
- 6. Front turn signal lamp (LED type)
- 7. Front fog lamp (LED type)

Rear combination lamp - 4door Type C

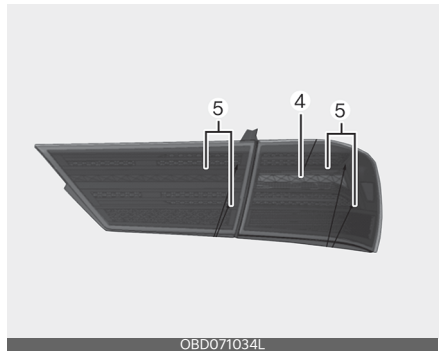

Light bulb position (Rear)

Rear combination lamp - 4door Type A

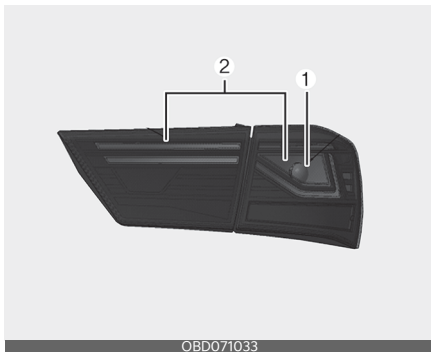

Rear combination lamp - 4door Type D

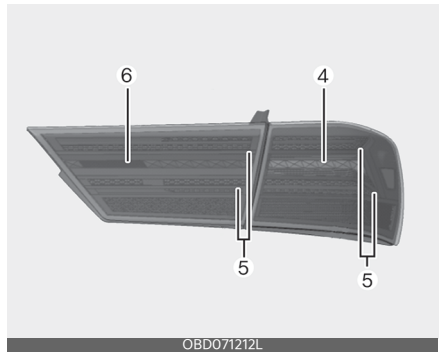

Rear combination lamp - 5door Type A

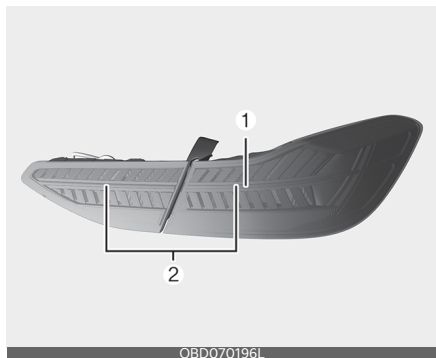

Rear turn signal lamp / Back up lamp - 4door

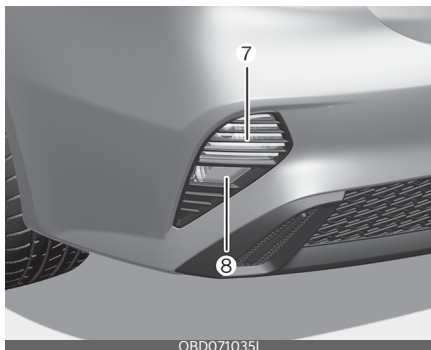

Rear combination lamp - 5door Type B

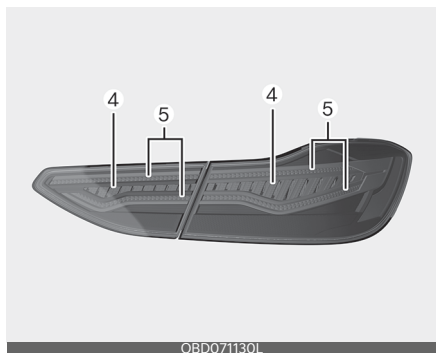

Rear turn signal lamp / Back up lamp - 5door

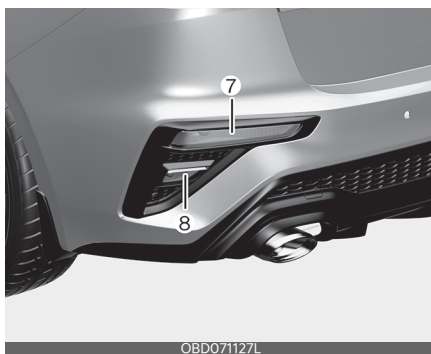

Rear fog lamp - 5 door

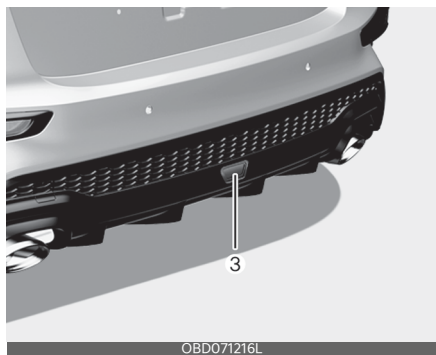

License plate lamp



High mounted stop lamp - 4door

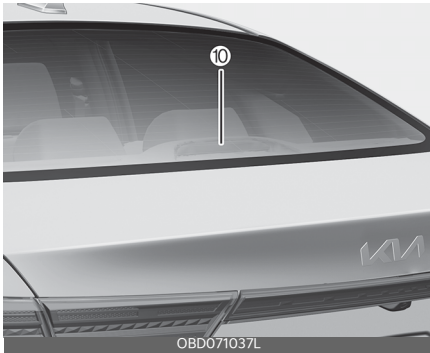

High mounted stop lamp - 5door



Light bulb position (Side)

Side repeater lamp - Type A

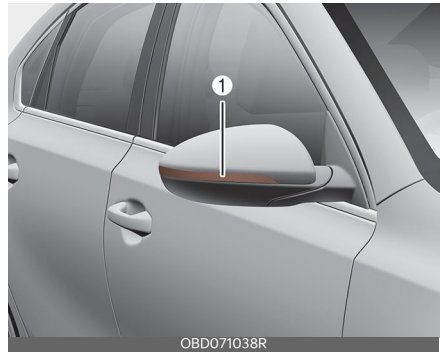

Side repeater lamp - Type B



1. Stop/Tail lamp (Bulb type)
2. Tail lamp (Bulb type)
3. Rear fog lamp (Bulb type)
4. Stop lamp (LED type)
5. Tail lamp (LED type)
6. Rear fog lamp (LED type)
7. Rear turn signal lamp (Bulb type)
8. Back Up lamp (Bulb type)
9. License plate lamp (Bulb type)
10. High mounted stop lamp (Bulb or LED type)

1. Side repeater lamp (LED type)
2. Side repeater lamp (Bulb type)

Headlamp (High/Low) (Bulb type) bulb replacement - Headlamp Type A

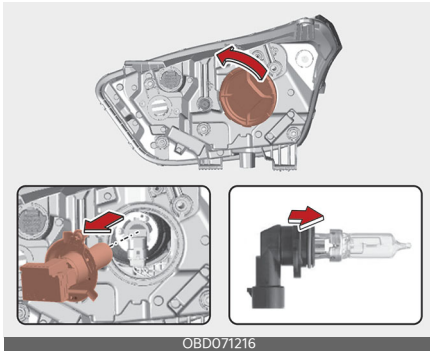

1. Open the bonnet.
2. Remove the headlamp bulb cover by turning it counterclockwise.
3. Disconnect the headlamp bulb socket-connector.
4. Remove the bulb-socket from the headlamp assembly by turning the bulb-socket counterclockwise until the tabs on the bulb-socket align with the slots on the headlamp assembly.
5. Install a new bulb-socket assembly in the headlamp assembly by aligning the tabs on the bulb-socket with the slots in the headlamp assembly. Push the bulb-socket into the headlamp assembly and turn the bulb-socket clockwise.
6. Connect the headlamp bulb socket-connector.
7. Install the headlamp bulb cover by turning it clockwise.

Headlamp bulb



WARNING

Halogen bulbs

- Halogen bulbs contain pressurized gas that will produce flying pieces of glass if broken.
- Always handle them carefully, and avoid scratches and abrasions. If the bulbs are lit, avoid contact with liquids. Never touch the glass with bare hands. Residual oil may cause the bulb to overheat and burst when lit. A bulb should be operated only when installed in a headlight.
- If a bulb becomes damaged or cracked, replace it immediately and carefully dispose of it.
- Wear eye protection when changing a bulb. Allow the bulb to cool down before handling it.

Front turn signal lamp (Bulb type) bulb replacement - Headlamp Type A

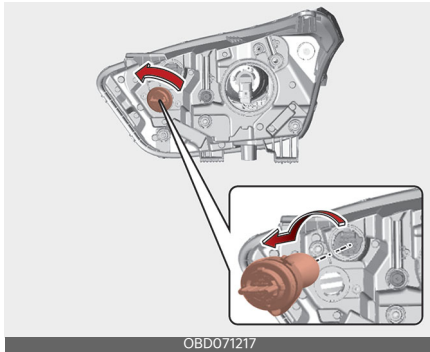

1. Open the bonnet.
2. Remove the bulb-socket from the headlamp assembly by turning the bulb-socket counterclockwise until the tabs on the bulb-socket align with the slots on the headlamp assembly.
3. Remove the bulb from the bulbsocket by pressing it in and rotating it counterclockwise until the tabs on the bulb align with the slots in the bulb-socket. Pull the bulb out of the bulb-socket.
4. Insert a new bulb by inserting it into the bulb-socket and rotating it until it locks into place.
5. Install the socket in the headlamp assembly by aligning the tabs on the bulb-socket with the slots in the assembly. Push the bulb-socket into the headlamp assembly and turn the socket clockwise.

Position lamp/Daytime running lamp (LED type) bulb replacement - Headlamp Type A



If the position lamp/daytime running lamp (LED) (1) does not operate, have your vehicle checked by a professional workshop.

Kia recommends to visit an authorised Kia dealer/service partner.

The LED lamps cannot be replaced as a single unit because it is an integrated unit. The LED lamps has to be replaced with the unit.

A skilled technician should check or repair the position lamp/daytime running lamp (LED), for it may damage related parts of the vehicle.

Headlamp (LED type) bulb replacement - Headlamp Type B

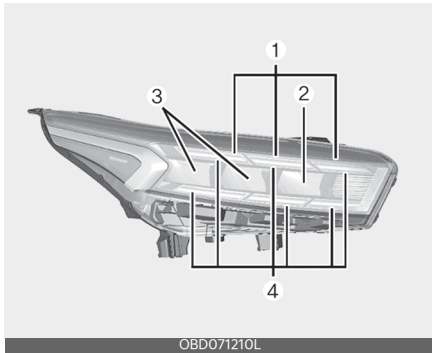

If the Low beam lamp (1), High beam lamp (2), Front turn signal lamp(3), Day time running lamp/Position lamp(4) does not operate, have your vehicle checked by a professional workshop. Kia recommends to visit an authorised Kia dealer/service partner.

The LED lamps cannot be replaced as a single unit because it is an integrated unit. The LED lamps has to be replaced with the unit.

A skilled technician should check or repair the head lamp (LED), for it may damage related parts of the vehicle.

Front fog lamp (LED type) bulb replacement

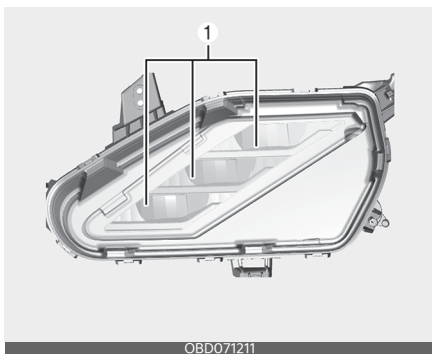

If the front fog lamp (LED) (1), does not operate, have your vehicle checked by a professional workshop. Kia recommends to visit an authorised Kia dealer/service partner. The LED lamps cannot be replaced as a single unit because it is an integrated unit. The LED lamps has to be replaced with the unit. A skilled technician should check or repair the front fog lamp (LED), for it may damage related parts of the vehicle.

Side repeater lamp (LED type) bulb Replacement

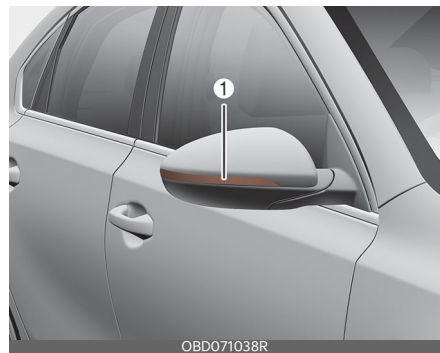

If the side repeater lamp (LED) (1) does not operate, have your vehicle checked by a professional workshop.

Kia recommends to visit an authorised Kia dealer/service partner.

The LED lamps cannot be replaced as a single unit because it is an integrated unit. The LED lamps has to be replaced with the unit.

A skilled technician should check or repair side repeater lamp (LED), for it may damage related parts of the vehicle.

Side repeater lamp (Bulb type) bulb Replacement

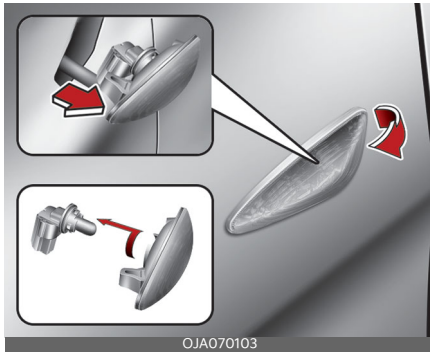

1. Remove the lamp assembly from the vehicle by prying the lens and pulling the assembly out.
2. Disconnect the bulb electrical connector.
3. Separate the socket and the lens parts by turning the socket counterclockwise until the tabs on the socket align with the slots on the lens part.
4. Remove the bulb by pulling it straight out.
5. Insert a new bulb in the socket.
6. Reassemble the socket and the lens part.
7. Connect the bulb electrical connector.
8. Reinstall the lamp assembly to the body of the vehicle.

Stop/Tail lamp (Bulb type) bulb replacement - 4 door type A, B

1. Open the trunk lid.
2. Open the service cover.



3. Loosen the nuts and disconnect the connector.

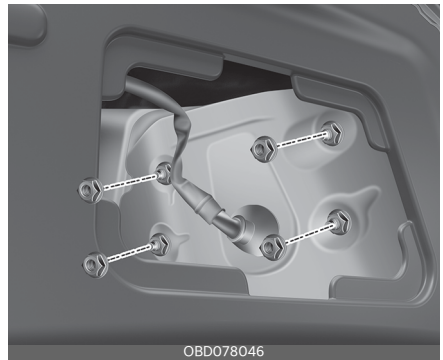

4. Remove the rear combination lamp assembly from the body of the vehicle.

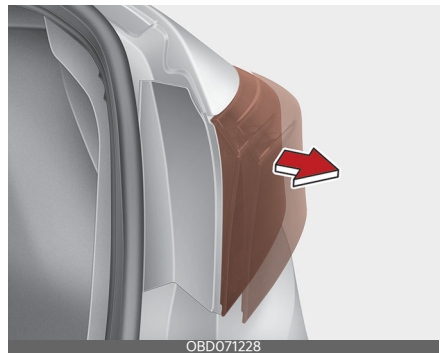

5. Remove the socket from the assembly by turning the socket counterclock-

wise until the tabs on the socket align with the slots on the assembly.

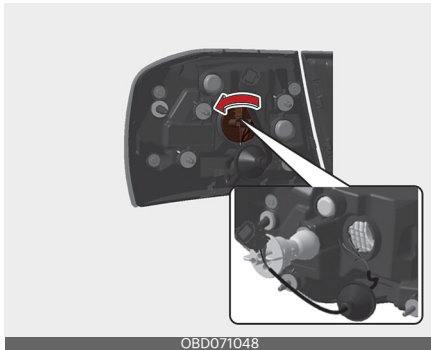

6. Remove the bulb from the socket by pressing it in and rotating it counterclockwise until the tabs on the bulb align with the slots in the socket. Pull the bulb out of the socket.
7. Insert a new bulb by inserting it into the socket and rotating it until it locks into place.
8. Install the socket in the assembly by aligning the tabs on the socket with the slots in the assembly. Push the socket into the assembly and turn the socket clockwise.
9. Install the rear combination lamp assembly to the body of the vehicle.
10. Install the service cover.

Stop/Tail lamp (Bulb type) bulb replacement - 5 door type A

1. Open the tail gate.
2. Loosen the light assembly retaining screws with a cross-tip screwdriver.

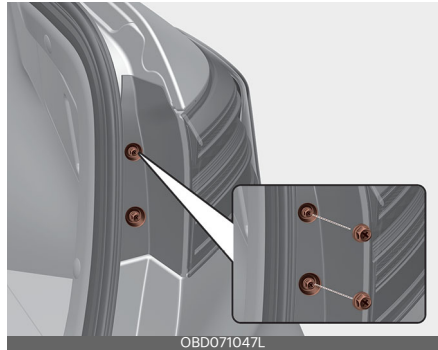

3. Remove the rear combination lamp assembly from the body of the vehicle.
4. Disconnect the rear combination lamp connector.

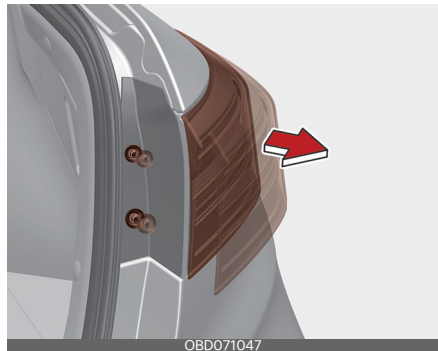

5. Remove the socket from the assembly by turning the socket counterclockwise until the tabs on the socket align with the slots on the assembly.

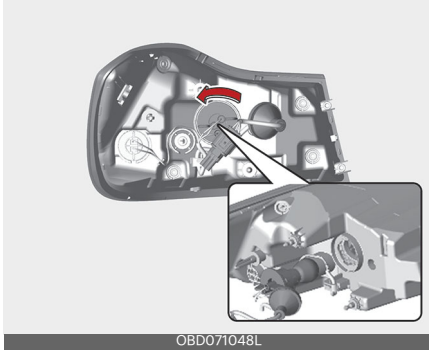

OBD071048L

6. Remove the bulb from the socket by pressing it in and rotating it counter-clockwise until the tabs on the bulb align with the slots in the socket. Pull the bulb out of the socket.
7. Insert a new bulb by inserting it into the socket and rotating it until it locks into place.
8. Install the socket in the assembly by aligning the tabs on the socket with the slots in the assembly. Push the socket into the assembly and turn the socket clockwise.
9. Install the rear combination lamp assembly to the body of the vehicle.

Tail lamp (Inside) (Bulb type) bulb replacement - 4door Type A, B

1. Open the trunk lid.



OBD071307

2. Loosen the retaining screw of the trunk lid cover and then remove the cover.
3. Remove the socket from the assembly by turning the socket counter-clockwise until the tabs on the socket align with the slots on the assembly.

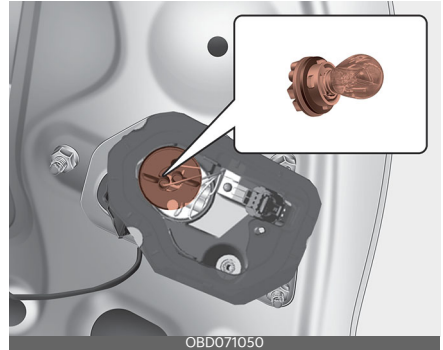

OBD071050

4. Remove the bulb from the socket by pressing it in and rotating it counter clockwise until the tabs on the bulb align with the slots in the socket. Pull the bulb out of the socket.
5. Insert a new bulb by inserting it into the socket and rotating it until it locks into place.
6. Install the socket in the assembly by aligning the tabs on the socket with the slots in the assembly. Push the socket into the assembly and turn the socket clockwise.
7. Install the trunk lid cover.

Tail lamp (Inside) (Bulb type) bulb replacement - 5 door type A

1. Open the tailgate lid.

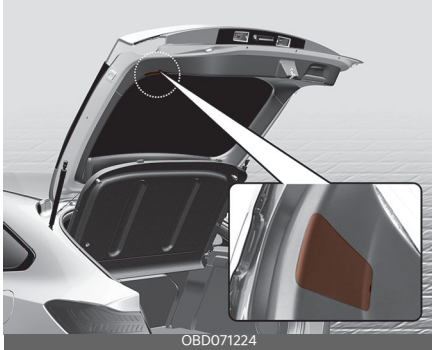

OBD071224

2. Loosen the retaining screw of the tailgate lid cover and then remove the cover.
3. Remove the socket from the assembly by turning the socket counterclockwise until the tabs on the socket align with the slots on the assembly.

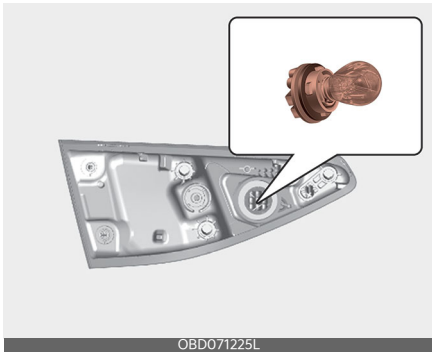

OBD071225L

4. Remove the bulb from the socket by pressing it in and rotating it counterclockwise until the tabs on the bulb align with the slots in the socket. Pull the bulb out of the socket.
5. Insert a new bulb by inserting it into the socket and rotating it until it locks into place.
6. Install the socket in the assembly by aligning the tabs on the socket with the slots in the assembly. Push the

socket into the assembly and turn the socket clockwise.

7. Install the tailgate lid cover.

Rear fog lamp (Bulb type) bulb replacement - 4door Type B



OBD071307

1. Open the trunk lid.
2. Loosen the retaining screw of the trunk lid cover and then remove the cover.
3. Remove the socket from the assembly by turning the socket counterclockwise until the tabs on the socket align with the slots on the assembly.

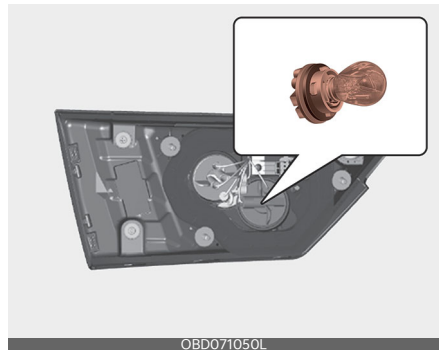

OBD071050L

4. Remove the bulb from the socket by pressing it in and rotating it counterclockwise until the tabs on the bulb align with the slots in the socket. Pull the bulb out of the socket.

5. Insert a new bulb by inserting it into the socket and rotating it until it locks into place.
6. Install the socket in the assembly by aligning the tabs on the socket with the slots in the assembly. Push the socket into the assembly and turn the socket clockwise.
7. Install the trunk lid cover.

Rear fog lamp (Bulb type) bulb replacement -5door

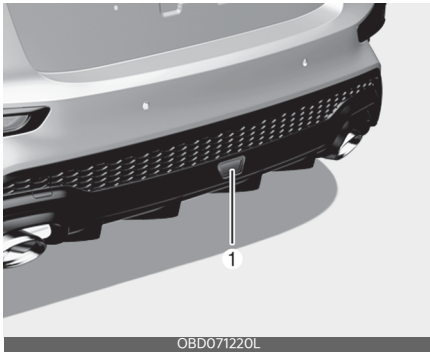

1. Disconnect the negative (-) battery terminal.
2. Remove the rear wheel guard after loosening the mounting screws and clips.
3. Disconnect the rear fog lamp connector.
4. Remove the socket from the assembly by turning the socket counterclockwise until the tabs on the socket align with the slots on the assembly.
5. Remove the bulb from the socket by pressing it in and rotating it counterclockwise until the tabs on the bulb align with the slots in the socket. Pull the bulb out of the socket.
6. Insert a new bulb by inserting it into the socket and rotating it until it locks into place.

7. Install the socket into the assembly by aligning the tabs on the socket with the slots in the assembly. Push the socket into the assembly and turn the socket clockwise.
8. Reinstall the lamp assembly to the body of the vehicle.

Stop and tail lamp (LED type) bulb replacement

Rear combination lamp - 4door Type C,
D

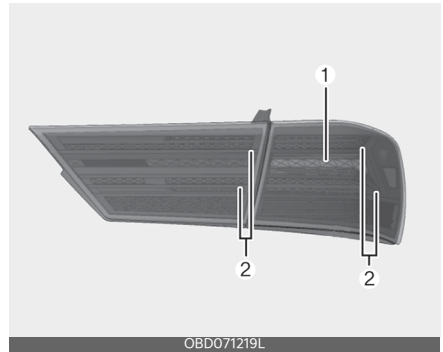

Rear combination lamp - 5door Type B

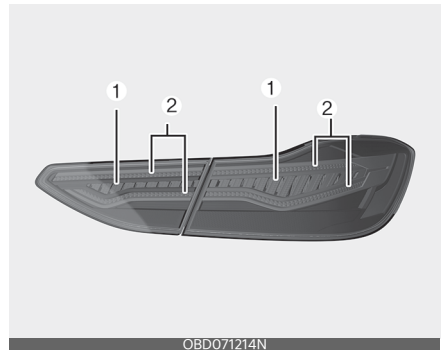

If the stop (1) and tail (2) lamp (LED), does not operate, have your vehicle checked by a professional workshop.

Kia recommends to visit an authorised Kia dealer/service partner.

The LED lamps cannot be replaced as a single unit because it is an integrated unit. The LED lamps has to be replaced with the unit.

A skilled technician should check or repair the stop and tail lamp (LED), for it may damage related parts of the vehicle.

Rear fog lamp (LED type) bulb replacement - 4door Type D



If the rear fog lamp (LED) (1), does not operate, have your vehicle checked by a professional workshop.

Kia recommends to visit an authorised Kia dealer/service partner.

The LED lamps cannot be replaced as a single unit because it is an integrated unit. The LED lamps has to be replaced with the unit.

A skilled technician should check or repair the rear fog lamp (LED), for it may damage related parts of the vehicle.

Rear turn signal lamp (Bulb type) bulb replacement

4 door

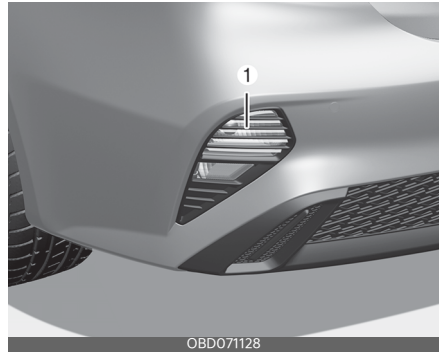

5 door

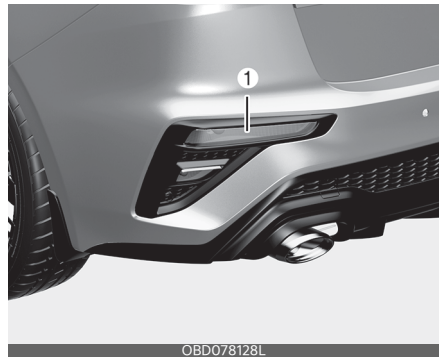

If the rear turn signal lamp (1) does not operate, have your vehicle checked by a professional workshop. Kia recommends to visit an authorised Kia dealer/service partner.

Back up lamp (Bulb type) bulb replacement

4 door



5 door

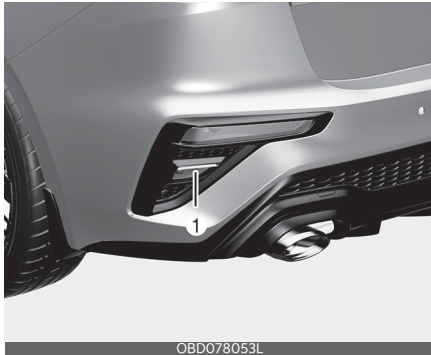

If the back up lamp (1) does not operate, have your vehicle checked by a professional workshop. Kia recommends to visit an authorised Kia dealer/service partner.

License plate lamp (Bulb type) bulb replacement

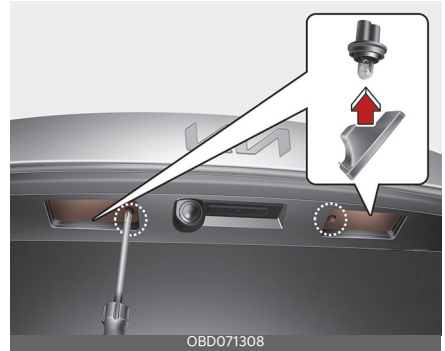

1. Using a flat-blade screwdriver, gently pry the lens cover from lamp housing.
2. Remove the socket from the assembly by turning the socket counterclockwise until the tabs on the socket align with the slots in the assembly.
3. Remove the bulb from bulb-socket by pulling it out.
4. Insert a new bulb by inserting it into the bulb-socket.
5. Install the socket in the assembly by aligning the tabs on the socket with the slots in the assembly. Push the socket into the assembly and turn the socket clockwise.
6. Align the lens cover tabs with the lamp housing notches and snap the lens into place.

High mounted stop lamp (bulb type) bulb replacement



1. Open the trunk/tailgate lid.
2. Remove the socket from the assembly by turning the socket counterclockwise until the tabs on the socket align with the slots on the assembly.
3. Remove the bulb from the socket by pressing it in and rotating it counterclockwise until the tabs on the bulb align with the slots in the socket. Pull the bulb out of the socket.
4. Insert a new bulb by inserting it into the socket and rotating it until it locks into place.
5. Install the socket in the assembly by aligning the tabs on the socket with the slots in the assembly. Push the socket into the assembly and turn the socket clockwise.

High mounted stop lamp bulb replacement

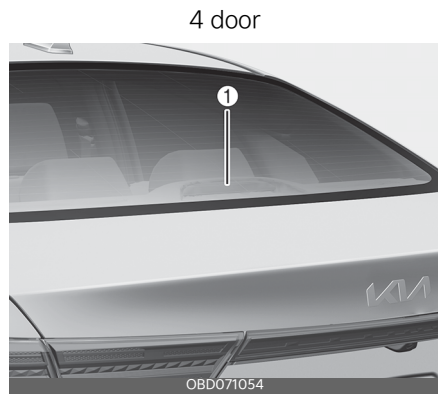

If the high mounted stop lamp (1) does not operate, have your vehicle checked by a professional workshop. Kia recommends to visit an authorised Kia dealer/ service partner.

Map lamp (Bulb type) bulb replacement



⚠ WARNING

Prior to working on the Interior lamps, ensure that the "OFF" button is depressed to avoid burning your fingers or receiving an electric shock.

1. Using a flat-blade screwdriver, gently pry the lens cover from lamp housing.
2. Remove the bulb by pulling it straight out.
3. Install a new bulb in the socket.
4. Align the lens cover tabs with the lamp housing notches and snap the lens into place.

⚠ CAUTION

Be careful not to dirty or damage the lens, lens tab, and plastic housings. Allow the bulb to cool down before handling it.

Map lamp (LED type) bulb replacement



If the map lamp (LED) (1), does not operate, have your vehicle checked by a professional workshop.

Kia recommends to visit an authorised Kia dealer/service partner.

The LED lamps cannot be replaced as a single unit because it is an integrated unit. The LED lamps has to be replaced with the unit.

A skilled technician should check or repair the map lamp (LED), for it may damage related parts of the vehicle.

Room lamp (Bulb type) bulb replacement

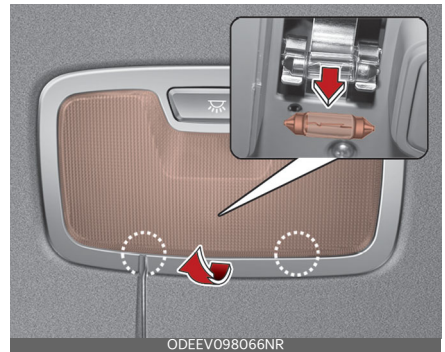

⚠ WARNING

Prior to working on the Interior lamps, ensure that the "OFF" button is depressed to avoid burning your fingers or receiving an electric shock.

1. Using a flat-blade screwdriver, gently pry the lens cover from lamp housing.
2. Remove the bulb by pulling it straight out.
3. Install a new bulb in the socket.
4. Align the lens cover tabs with the lamp housing notches and snap the lens into place.

⚠ CAUTION

Be careful not to dirty or damage the lens, lens tab, and plastic housings.

Room lamp (LED type) bulb replacement

If the room lamp (LED) (1), does not operate, have your vehicle checked by a professional workshop.

Kia recommends to visit an authorised Kia dealer/service partner.

The LED lamps cannot be replaced as a single unit because it is an integrated unit. The LED lamps has to be replaced with the unit.

A skilled technician should check or repair the room lamp (LED), for it may damage related parts of the vehicle.

Vanity mirror lamp (Bulb type) bulb replacement**⚠ WARNING**

Prior to working on the Interior lamps, ensure that the "OFF" button is depressed to avoid burning your fingers or receiving an electric shock.

1. Using a flat-blade screwdriver, gently pry the lamp assembly from interior.
2. Remove the bulb by pulling it straight out.
3. Install a new bulb in the socket.
4. Install the lamp assembly to interior.

⚠ CAUTION

Be careful not to dirty or damage the lens, lens tab, and plastic housings.

Trunk/tailgate room lamp (Bulb type) bulb replacement

4 door

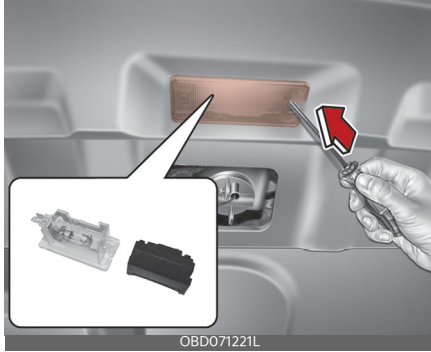

5 door

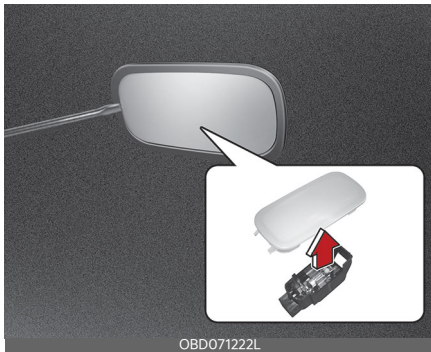

1. Using a flat-blade screwdriver, gently pry the lens cover from lamp housing.
2. Remove the bulb by pulling it straight out.
3. Install a new bulb in the socket.
4. Align the lens cover tabs with the lamp housing notches and snap the lens into place.

⚠ CAUTION

Be careful not to dirty or damage the lens, lens tab, and plastic housings.

* NOTICE

If the LED lamp does not operate, have your vehicle checked by a professional workshop. Kia recommends to visit an authorised Kia dealer/service partner.

Glove box lamp (Bulb type) replacement

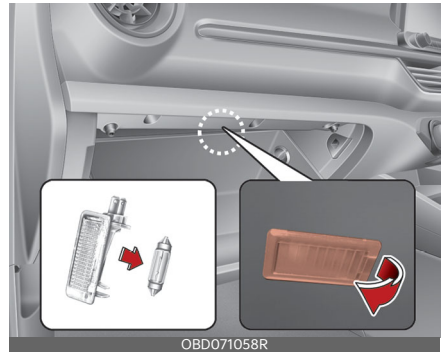

1. Using a flat-blade screwdriver, gently pry the lamp assembly from interior.
2. Remove the bulb by pulling it straight out.
3. Install a new bulb in the socket.
4. Install the lamp assembly to interior.

⚠ CAUTION

Be careful not to dirty or damage the lens, lens tab, and plastic housings.

Headlamp and front fog lamp aiming (for Europe)

Headlamp aiming

Type A

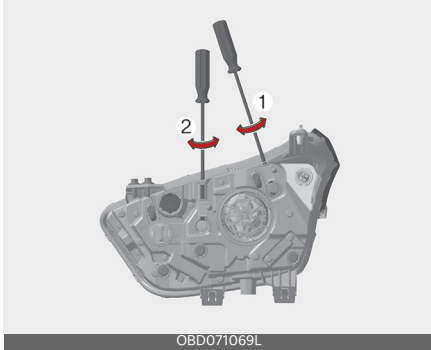

Type B

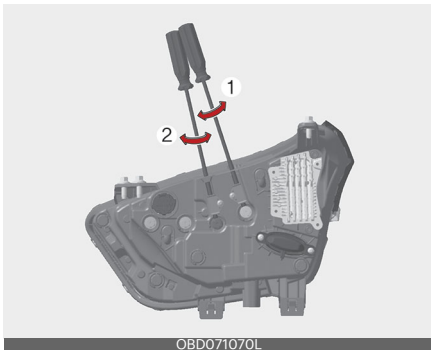

1. Inflate the tyres to the specified pressure and remove any loads from the vehicle except the driver, spare tyre, and tools.
2. The vehicle should be placed on a flat floor.
3. Draw vertical lines (Vertical lines passing through respective head lamp centres) and a horizontal line (Horizontal line passing through centre of head lamps) on the screen.

4. With the head lamp and battery in normal condition, aim the head lamps so the brightest portion falls on the horizontal and vertical lines.
5. To aim the low and high beams left or right, turn the driver (1) clockwise or counterclockwise. To aim the low and high beams up or down, turn the driver (2) clockwise or counterclockwise.

Front fog lamp aiming

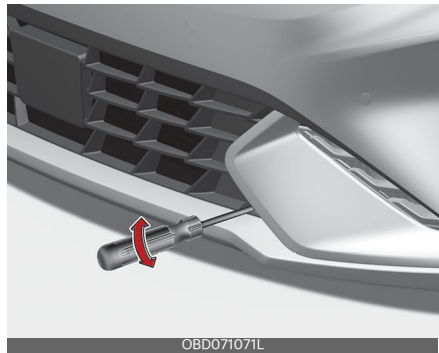

The front fog lamp can be aimed in the same manner as the head lamps aiming. With the front fog lamps and battery in normal condition, aim the front fog lamps.

To aim the front fog lamp up or down, turn the driver clockwise or counterclockwise.

Aiming point

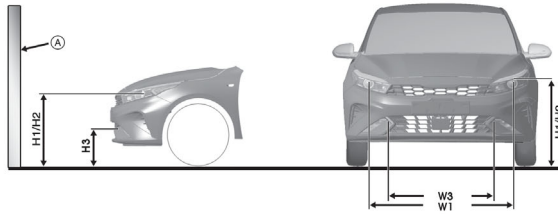

OBDO71073L

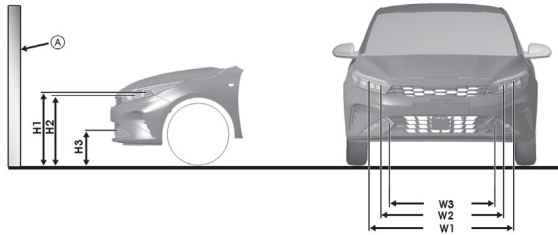

OBDO71072L

* A : Screen

Unit: mm (in)

Vehicle condition	Head lamp (Halogen type)			Head lamp (LED type)			
	Ground Height	Distance between lamps		Ground Height		Distance between lamps	
	Low/High beam	Low/High beam		Low beam	High beam	Low beam	High beam
	H1	W1	W2	H1'	H2'	W1'	W2'
Without driver / [mm (in)]	713 (28.1)	1310 (51.5)	1310 (51.5)	711 (28.0)	683 (26.9)	1334 (52.5)	1127 (44.4)
With driver / [mm (in)]	703 (27.7)	1310 (51.5)	1310 (51.5)	701 (27.6)	673 (26.5)	1334 (52.5)	1127 (44.4)

Vehicle condition	Front Fog lamp	
	Ground Height	Distance between lamps
	H3	W3
Without driver [mm (in)]	323 (12.7)	1206 (47.5)
With driver [mm (in)]	313 (12.3)	1206 (47.5)

Head lamp low beam (LHD)

1. Turn the low beam on without driver aboard.
2. The cut-off line should be projected in the cut-off line shown in the picture.
3. When aiming the low beam, vertical aiming should be adjusted after adjusting the horizontal aiming.
4. If head lamp levelling device is equipped, adjust the head lamp levelling device switch with 0 positions.

Based on 10m screen

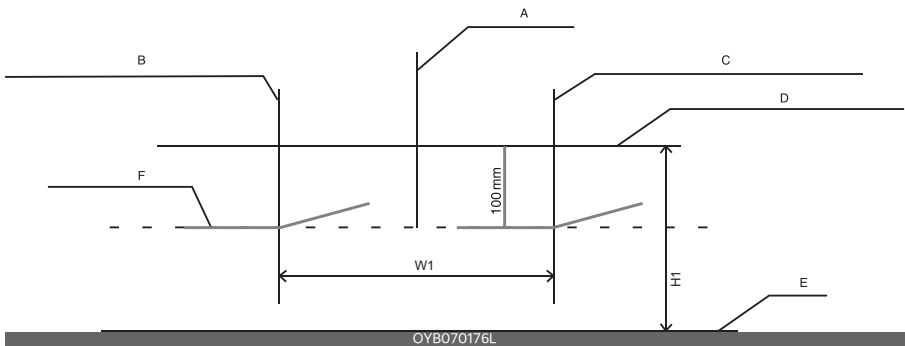

- A : Vehicle axis
- B : Vertical line of the left head lamp bulb centre
- C : Vertical line of the right head lamp bulb centre
- D : Horizontal line of head lamp bulb centre
- E : Ground
- F : Cut-Off line

Based on 10m screen

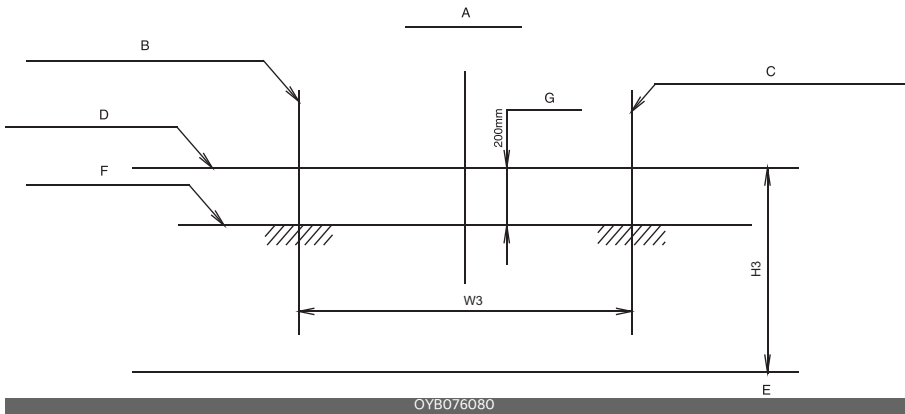

- A : Vehicle axis
- B : Vertical line of the left fog lamp bulb centre
- C : Vertical line of the right fog lamp bulb centre
- D : Horizontal line of fog lamp bulb centre
- E : Ground
- F : Cut-Off line
- G : Upper limit

Appearance care

Exterior care

* NOTICE

If you park the vehicle around a stainless signboard or windscreen building etc., the plastic exterior trim (bumper, spoiler, garnish, lamp, outside mirror etc.) may be damaged by reflected sunlight from the external structure. To avoid damaging the plastic exterior trim, park the vehicle away from the areas where the reflected light may occur or use a vehicle cover (Depending on the vehicle, the type of exterior trim applied such as spoiler may differ).

Exterior general caution

It is very important to follow the label directions when using any chemical cleaner or polish. Read all warning and caution statements that appear on the label.

Finish maintenance

Washing

To help protect your vehicle's finish from rust and deterioration, wash it thoroughly and frequently at least once a month with lukewarm or cold water.

If you use your vehicle for off-road driving, you should wash it after each off-road trip. Pay special attention to the removal of any accumulation of salt, dirt, mud, and other foreign materials. Make sure the drain holes in the lower edges of the doors and rocker panels are kept clear and clean.

Insects, tar, tree sap, bird droppings, industrial pollution and similar deposits can damage your vehicle's finish if not removed immediately.

Even prompt washing with plain water may not completely remove all these deposits. A mild soap, safe for use on painted surfaces, may be used.

After washing, rinse the vehicle thoroughly with lukewarm or cold water. Do not allow soap to dry on the finish.

⚠ CAUTION

- Do not use strong soap, chemical detergents or hot water, and do not wash the vehicle in direct sunlight or when the body of the vehicle is warm.
- Be careful when washing the side windows of your vehicle.
Especially, with high-pressure water, water may leak through the windows and wet the interior.
- To prevent damage to the plastic parts and lamps, do not clean with chemical solvents or strong detergents.

⚠ WARNING

Wet brakes

After washing the vehicle, test the brakes whilst driving slowly to see if they have been affected by water. If braking performance is impaired, dry the brakes by applying them lightly whilst maintaining a slow forward speed.

High-pressure washing

- When using high-pressure washers, make sure to maintain sufficient distance from the vehicle.
Insufficient clearance or excessive pressure can lead to component damage or water penetration.
- Do not spray the camera, sensors or its surrounding area directly with a

high pressure washer. Shock applied from high pressure water may cause the device to not operate normally.

- Do not bring the nozzle tip close to boots (rubber or plastic covers) or connectors as they may be damaged if they come into contact with high pressure water.

⚠ CAUTION

- Water washing in the engine compartment including high pressure water washing may cause the failure of electrical circuits located in the engine compartment.



OBD071060L

- Never allow water or other liquids to come in contact with electrical/electronic components inside the vehicle as this may damage them.

Waxing

Wax the vehicle when water will no longer bead on the paint.

Always wash and dry the vehicle before waxing. Use a good quality liquid or paste wax, and follow the manufacturer's instructions. Wax all metal trim to protect it and to maintain its luster.

Removing oil, tar, and similar materials with a spot remover will usually strip the

wax from the finish. Be sure to re-wax these areas even if the rest of the vehicle does not yet need waxing. Do not apply wax on embossed unpainted unit, as it may tarnish the unit.

⚠ CAUTION

- Wiping dust or dirt off the body with a dry cloth will scratch the finish.
- Do not use steel wool, abrasive cleaners, acid detergents or strong detergents containing high alkaline or caustic agents on chrome-plated or anodized aluminum parts. This may result in damage to the protective coating and cause discoloration or paint deterioration.

Finish damage repair

Deep scratches or stone chips in the painted surface must be repaired promptly. Exposed metal will quickly rust and may develop into a major repair expense.

* NOTICE

If your vehicle is damaged and requires any metal repair or replacement, be sure the body shop applies anti-corrosion materials to the parts repaired or replaced.

Bright-metal maintenance

- To remove road tar and insects, use a tar remover, not a scraper or other sharp object.
- To protect the surfaces of brightmetal parts from corrosion, apply a coating of wax or chrome preservative and rub to a high luster.
- During winter weather or in coastal areas, cover the bright metal parts with a heavier coating of wax or pre-

servative. If necessary, coat the parts with non-corrosive petroleum jelly or other protective compound.

Underbody maintenance

Corrosive materials used for ice and snow removal and dust control may collect on the underbody. If these materials are not removed, accelerated rusting can occur on underbody parts such as the fuel lines, frame, floor pan and exhaust system, even though they have been treated with rust protection.

Thoroughly flush the vehicle underbody and wheel openings with lukewarm or cold water once a month, after off-road driving and at the end of each winter. Pay special attention to these areas because it is difficult to see all the mud and dirt. It will do more harm than good to wet down the road grime without removing it. The lower edges of the doors, rocker panels, and frame members have drain holes that should not clog with dirt; trapped water in these areas can cause rusting.

WARNING

After washing the vehicle, test the brakes whilst driving slowly to see if they have been affected by water. If braking performance is impaired, dry the brakes by applying them lightly whilst maintaining a slow forward speed.

Aluminum wheel maintenance

The aluminum wheels are coated with a clear protective finish.

- Do not use any abrasive cleaner, polishing compound, solvent, or wire brushes on aluminum wheels. They may scratch or damage the finish.
- Clean the wheel when it has cooled.

- Use only a mild soap or neutral detergent, and rinse thoroughly with water. Also, be sure to clean the wheels after driving on salted roads. This helps prevent corrosion.
- Avoid washing the wheels with high-speed car wash brushes.
- Do not use any alkaline or acid detergent. It may damage and corrode the aluminum wheels coated with a clear protective finish.

Corrosion protection

Protecting your vehicle from corrosion

By using the most advanced design and construction practices to combat corrosion, we produce vehicles of the highest quality. However, this is only part of the job. To achieve the longterm corrosion resistance your vehicle can deliver, the owner's cooperation and assistance is also required.

Common causes of corrosion

The most common causes of corrosion on your vehicle are:

- Road salt, dirt and moisture that is allowed to accumulate underneath the vehicle.
- Removal of paint or protective coatings by stones, gravel, abrasion or minor scrapes and dents which leave unprotected metal exposed to corrosion.

High-corrosion areas

If you live in an area where your vehicle is regularly exposed to corrosive materials, corrosion protection is particularly important. Some of the common causes

of accelerated corrosion are road salts, dust control chemicals, ocean air and industrial pollution.

Moisture breeds corrosion

Moisture creates the conditions in which corrosion is most likely to occur. For example, corrosion is accelerated by high humidity, particularly when temperatures are just above freezing. In such conditions, the corrosive material is kept in contact with the vehicle's surface by moisture that evaporate slowly.

Mud is particularly corrosive because it dries slowly and holds moisture in contact with the vehicle.

Although the mud appears to be dry, it can still retain moisture and promote corrosion.

High temperatures can also accelerate corrosion of parts that are not properly ventilated so the moisture can be dispersed.

For all these reasons, it is particularly important to keep your vehicle clean and free of mud or accumulations of other materials. This applies not only to the visible surfaces but particularly to the underside of the vehicle.

To help prevent corrosion

You can help prevent corrosion from getting started by observing the following:

Keep your vehicle clean

The best way to prevent corrosion is to keep your vehicle clean and free of corrosive materials. Attention to the underside of the vehicle is particularly important.

- If you live in a high-corrosion area — where road salts are used, near the ocean, areas with industrial pollution, acid rain, etc.—, you should take extra care to prevent corrosion. In winter, hose off the underside of your vehicle at least once a month and be sure to clean the underside thoroughly when winter is over.
- When cleaning underneath the vehicle, give particular attention to the components under the fenders and other areas that are hidden from view. Do a thorough job; just dampening the accumulated mud rather than washing it away will accelerate corrosion rather than prevent it. Water under high pressure and steam are particularly effective in removing accumulated mud and corrosive materials.
- When cleaning lower door panels, rocker panels and frame members, be sure that drain holes are kept open so that moisture can escape and not be trapped inside to accelerate corrosion.

Keep your garage dry

Don't park your vehicle in a damp, poorly ventilated garage. This creates a favorable environment for corrosion. This is particularly true if you wash your vehicle in the garage or drive it into the garage when it is still wet or covered with snow, ice or mud. Even a heated garage can contribute to corrosion unless it is well ventilated so moisture is dispersed.

Keep paint and trim in good condition

Scratches or chips in the finish should be covered with "touch-up" paint as soon as

possible to reduce the possibility of corrosion. If bare metal is showing through, the attention of a qualified body and paint shop is recommended.

Bird droppings : Bird droppings are highly corrosive and may damage painted surfaces in just a few hours. Always remove bird droppings as soon as possible.

Don't neglect the interior

Moisture can collect under the floor mats and carpeting and cause corrosion. Check under the mats periodically to be sure the carpeting is dry. Use particular care if you carry fertilizers, cleaning materials or chemicals in the vehicle.

These should be carried only in proper containers and any spills or leaks should be cleaned up, flushed with clean water and thoroughly dried.

Interior care

Interior general precautions

Prevent chemicals such as perfume, cosmetic oil, sun cream, hand cleaner, and air freshener from contacting the interior parts because they may cause damage or discoloration. If they do contact the interior parts, wipe them off immediately. If necessary, use a mixture of warm water and mild non-detergent cleaner (test all cleaners on a concealed area before use). Use proper car cleaner to clean interior parts.

CAUTION

Never allow water or other liquids to come in contact with electrical/electronic components inside the vehicle as this may damage them.

CAUTION

When cleaning leather products (steering wheel, seats etc.), use neutral detergents or low alcohol content solutions. If you use high alcohol content solutions or acid/alkaline detergents, the colour of the leather may fade or the surface may get stripped off.

Cleaning the upholstery and interior trim

Car interior surfaces

Remove dust and loose dirt from interior surfaces with a whisk broom or a vacuum cleaner. If necessary, clean interior surfaces with a mixture of warm water and mild non-detergent cleaner (test all cleaners on a concealed area before use).

Fabric

Remove dust and loose dirt from fabric with a whisk broom or vacuum cleaner. Clean with a mild soap solution recommended for upholstery or carpets. Remove fresh spots immediately with a fabric spot cleaner. If fresh spots do not receive immediate attention, the fabric can be stained and its colour can be affected. Also, its fire-resistant properties can be reduced if the material is not properly maintained.

CAUTION

Using anything but recommended cleaners and procedures may affect the fabric's appearance and fire-resistant properties.

Cleaning the lap/shoulder belt webbing

Clean the belt webbing with any mild soap solution recommended for cleaning upholstery or carpet. Follow the instructions provided with the soap. Do not bleach or re-dye the webbing because this may weaken it.

Cleaning the interior window glass

If the interior glass surfaces of the vehicle become fogged (that is, covered with an oily, greasy or waxy film), they should be cleaned with a glass cleaner. Follow the directions on the glass cleaner container.

CAUTION

Do not scrape or scratch the inside of the rear window. This may result in damage of the rear window defroster grid.

Taking care of leather seats

- Vacuum the seat periodically to remove dust and sand on the seat. It will prevent abrasion or damage of the leather and maintain its quality.
- Wipe the leather seat cover often with dry or soft cloth.
- Sufficient use of a leather protective may prevent abrasion of the cover and helps maintain the colour. Be sure to read the instructions and consult a specialist when using leather coating or protective agents.
- Leather with bright colours (beige, cream beige) is easily contaminated and clear in appearance. Clean the seats frequently.
- Avoid wiping with wet cloth. It may cause the surface to crack.

Cleaning the leather seats

- Remove all contaminations instantly. Refer to instructions below for removal of each contaminant.
- Cosmetic products (sunscreen, foundation, etc.)
 - Apply cleansing cream on a cloth and wipe the contaminated point. Wipe off the cream with a wet cloth and remove water with a dry cloth.
- Beverages (coffee, soft drink, etc.)
 - Apply a small amount of neutral detergent and wipe until contaminations do not smear.
- Oil
 - Remove oil instantly with absorbable cloth and wipe with stain remover for leather only.
- Chewing gum
 - Harden the gum with ice and remove gradually.

Fabric seat cover using precautions (if equipped)

Please clean the fabric seats regularly with a vacuum cleaner in consideration of fabric material characteristics. If they are heavily soiled with beverage stains, etc., use a suitable interior cleaner. To prevent damage to seat covers, wipe off the seat covers down to the seams with a large wiping motion and moderate pressure using a soft sponge or microfiber cloth.

Velcro closures on clothing or sharp objects may cause snagging or scratches on the surface of the seats. Make sure not to rub such objects against the surface.

Emission control system (if equipped)

The emission control system of your vehicle is covered by a written limited warranty. Please see the warranty information contained in the Warranty & Maintenance book in your vehicle.

Your vehicle is equipped with an emission control system to meet all applicable emission regulations.

There are three emission control systems, as follows.

1. Crankcase emission control system
2. Evaporative emission control system
3. Exhaust emission control system

In order to assure the proper function of the emission control systems, have your vehicle inspected and maintained by a professional workshop in accordance with the maintenance schedule in this manual. Kia recommends to visit an authorised Kia dealer/service partner.

Caution for the Inspection and Maintenance Test (With Electronic Stability Control (ESC) system)

- To prevent the vehicle from misfiring during dynamometer testing, turn the Electronic Stability Control (ESC) system off by pressing the ESC switch.
- After dynamometer testing is completed, turn the ESC system back on by pressing the ESC switch again.

1. Crankcase emission control system

The positive crankcase ventilation system is employed to prevent air pollution caused by blow-by gases being emitted from the crankcase. This system supplies fresh filtered air to the crankcase through the air intake hose. Inside the crankcase, the fresh air mixes with blow-

by gases, which then pass through the PCV valve into the induction system.

2. Evaporative emission control system

The Evaporative Emission Control System is designed to prevent fuel vapours from escaping into the atmosphere.

Canister

Fuel vapours generated inside the fuel tank are absorbed and stored in the onboard canister. When the engine is running, the fuel vapours absorbed in the canister are drawn into the surge tank through the purge control solenoid valve.

Purge Control Solenoid Valve (PCSV)

The purge control solenoid valve is controlled by the Engine Control Module (ECM); when the engine coolant temperature is low during idling, the PCSV closes so that evaporated fuel is not taken into the engine. After the engine warms up during ordinary driving, the PCSV opens to introduce evaporated fuel to the engine.

3. Exhaust emission control system

The Exhaust Emission Control System is a highly effective system which controls exhaust emissions whilst maintaining good vehicle performance.

Engine exhaust gas precautions (carbon monoxide)

- Carbon monoxide can be present with other exhaust fumes. Therefore, if you smell exhaust fumes of any kind inside your vehicle, have it inspected

and repaired immediately. If you ever suspect exhaust fumes are coming into your vehicle, drive it only with all the windows fully open. Have your vehicle checked and repaired immediately.

WARNING

Exhaust

Engine exhaust gases contain carbon monoxide (CO). Though colourless and odourless, it is dangerous and could be lethal if inhaled. Follow the instructions on this page to avoid CO poisoning.

- Do not operate the engine in confined or closed areas (such as garages) any more than what is necessary to move the vehicle in or out of the area.
- When the vehicle is stopped in an open area for more than a short time with the engine running, adjust the ventilation system (as needed) to draw outside air into the vehicle.
- Never sit in a parked or stopped vehicle for any extended time with the engine running.
- When the engine stalls or fails to start, excessive attempts to restart the engine may cause damage to the emission control system.

Operating precautions for catalytic converters (if equipped)

WARNING

Fire

- A hot exhaust system can ignite flammable items under your vehicle. Do not park the vehicle over or near flammable objects, such as grass, vegetation, paper, leaves, etc.

- The exhaust system and catalytic system are very hot whilst the engine is running or immediately after the engine is turned off. Keep away from the exhaust system and catalytic, you may get burned.

Also, do not remove the heat sink around the exhaust system, do not seal the bottom of the vehicle or do not coat the vehicle for corrosion control. It may present a fire risk under certain conditions.

Your vehicle is equipped with a catalytic converter emission control device.

Therefore, the following precautions must be observed:

- Make sure to refuel your vehicle according refer to "Fuel requirements" on page 1-2.
- Do not operate the vehicle when there are signs of engine malfunction, such as misfire or a noticeable loss of performance.
- Do not misuse or abuse the engine. Examples of misuse are coasting with the ignition off and descending steep grades in gear with the ignition off.
- Do not operate the engine at high idle speed for extended periods (5 minutes or more).
- Do not modify or tamper with any part of the engine or emission control system. All inspections and adjustments must be made by a professional workshop. Kia recommends to visit an authorised Kia dealer/service centre.
- Avoid driving with an extremely low fuel level. Running out of fuel could cause the engine to misfire, damaging the catalytic converter.

Failure to observe these precautions could result in damage to the catalytic converter and to your vehicle.

Additionally, such actions could void your warranties.

Petrol Particulate Filter (PPF) (if equipped)

The Petrol Particulate Filter (PPF) is the system that removes the soot from the exhaust gas. Unlike a disposable air filter, the PPF system automatically burns (oxidizes) and removes the accumulated soot whilst driving.

However, repeated short-distance driving or long-distance driving at a low speed can stop the accumulated soot from automatically being removed by the PPF system. If the accumulated soot reaches a certain amount, the PPF warning light () will illuminate. To re-

operate the PPF system, the vehicle should be driven for more than 30 minutes at a speed of 80km/h (50 mph) and faster. Ensure the following conditions are met: safe road conditions, transmission 3 or above, and engine speed of 1,500-4,000 rpm. Driving at 80 km/h (50 mph) or faster for recommended hours will get the PPF system back to work and stop the PPF warning light.

If the PPF warning light stays on or the warning message "Check exhaust system" pops up even after driving at recommended speed and for recommended hours, visit a professional workshop and check the PPF system. Kia recommends to visit an authorised Kia dealer/service partner. Constant driving with the PPF warning light on can damage the PPF system and undermine fuel economy.

Specifications & Consumer information

Dimensions	9-2
Engine	9-4
Gross vehicle weight	9-5
Luggage volume	9-6
Air conditioning system	9-6
Bulb wattage	9-7
Tyres and wheels	9-8
Recommended lubricants and capacities	9-10
• Recommended SAE viscosity number.....	9-12
Vehicle identification number (VIN)	9-13
Vehicle certification label	9-14
Tyre specification and pressure label	9-14
Engine number	9-15
Air conditioner compressor label	9-16
Refrigerant label	9-16
Declaration of conformity	9-17
FUEL LABEL	9-17
• Petrol engine	9-17

Specifications & Consumer information

Dimensions

4 Door

Item		mm (in)
Overall length		4,640 (182.7)
Overall width		1,800 (70.9)
Overall height		1440 (56.7)GT: 1435 (56.5)
Front tread	195/65R15	1,563 (61.5)
	205/55R16	1,555 (61.2)
	225/45R17	1,549 (61.0)
	225/40R18	1,545 (60.9)
Rear tread	195/65R15	1,572 (61.9)
	205/55R16	1,564 (61.6)
	225/45R17	1,558 (61.3)
	225/45R17 (GT)	1,563 (61.5)
	225/40R18	1,559 (61.4)
Wheelbase		2,700 (106.3)

5 Door

Item		mm (in)
Overall length		4,510 (177.6)
Overall width		1,800 (70.9)
Overall height		1445 (56.9)GT: 1440 (56.7)
Front tread	195/65R15	1,563 (61.5)
	205/55R16	1,555 (61.2)
	225/45R17	1,549 (61.0)
	225/40R18	1,545 (60.9)

Item		mm (in)
Rear tread	195/65R15	1,572 (61.9)
	205/55R16	1,564 (61.6)
	225/45R17	1,558 (61.3)
	225/45R17 (GT)	1,563 (61.5)
	225/40R18	1,559 (61.4)
Wheelbase		2,700 (106.3)

Engine

Item	Petrol Engine			
	(Petrol) 1.6 MPI	(Petrol) 2.0 MPI	(Petrol) 1.6 T-GDi	Smartstream G 1.6
Displacement [cc (cu. in.)]	1,591 (97.09)	1,999 (121.9)	1,591 (97.09)	1,598 (97.51)
Bore x Stroke [mm (in.)]	77 x 85.44 (3.03 x 3.36)	81 x 97 (3.19 x 3.82)	77 x 85.44 (3.03 x 3.36)	75.6 x 89.0 (2.976 x 3.503)
Firing order	1-3-4-2	1-3-4-2	1-3-4-2	1-3-4-2
No. of cylinders	4, In-line	4, In-line	4, In-line	4, In-line

Gross vehicle weight

kg (lbs)

Item		For Europe	Except Europe	For Australia and New Zealand
Petrol) 1.6 MPI	6MT	1,660 (3,660) (only Russia)	4 Door : 1,670 (3,682)	-
	6AT	1,680 (3,704)	4 Door : 1,690 (3,726)	-
5 Door : 1,720 (3,792)				
(Petrol) 2.0 MPI	6MT	-	4 Door : 1,700 (3,748)	4 Door : 1,750 (3,858)
			5 Door : 1,730 (3,814)	5 Door : 1,770 (3,902)
	6AT	1,720 (3,792)	4 Door : 1,730 (3,814)	4 Door : 1,770 (3,902)
			5 Door : 1,750 (3,858)	5 Door : 1,800 (3,968)
IVT	-	5 Door : 1750 (3,858)	-	
(Petrol) 1.6 T-GDi	7DCT	1,780 (3,924)	4 Door : 1,800(3,968)	4 Door : 1,820 (4,012)
			5 Door : 1,830(4,304)	5 Door : 1,850 (4,079)
Smartstream G1.6	IVT	-	4 Door : 1,690 (3,726)	-

Luggage volume

Item	Volume
VDA / SAE (cu ft)	4 Door : 502 (17.7) / 434 (15.3) 5 Door : 428 (15.1) / 741 (26.2)

Air conditioning system

Item	Weight of volume	Classification
Refrigerant	500 ± 25g	R-134a
		R-1234yf
Compressor lubricant	110 ±10cc	PAG 46

Please contact a professional workshop for more details.

Kia recommends to contact an authorised Kia dealer/service partner.

Bulb wattage

Light Bulb				Wattage (W)	Bulb type
Front	Headlamps	High/Low	Type A	HB3	65W
		Low	Type B	LED	LED
		High		LED	LED
	Daytime running light			LED	LED
	Position lamp			LED	LED
	Turn signal lamp			21W	PY21W
	Front fog lamp *			LED	LED
Rear	Stop/Tail	4Door Type A		P21/5W	21/5W
	Tail			P21W	21/5W
	Stop	4Door Type B		LED	LED
	Tail			LED	LED
	Stop/Tail	5Door Type A		P21/5W	21/5W
	Tail			W5W	5W
	Stop	5Door Type B		LED	LED
	Tail			LED	LED
	Turn signal lamp			21W	PY21W
	Back up lamp			16W	W16W
	Rear fog light *			21W or LED	P21W or LED
	High mounted stop lamp *			21W	P21W or LED
	License plate lamp			5W X 2EA	W5W
	Interior	Map lamps *			10W X 2EA
Room lamp			10W	FESTOON	
Luggage lamp			5W	FESTOON	
Glove box lamp			8W	FESTOON	
Vanity mirror lamps *			5W	FESTOON	

* If equipped

Tyres and wheels

For Europe

Item	Tyre size	Wheel size	Load Capacity		Speed capacity		Inflation pressure [bar(psi, kPa)]				Wheel lugnut torque Kg·m (lbf·ft, N·m)
			Ll ^{*1}	Kg	SS ^{*2}	Km/h	Normal load		Maximum load		
							Front	Rear	Front	Rear	
Full size tyre	195/65R15	6.0Jx15	91	615	H	210	2.3 (33,2 30)	2.3 (33,2 30)	2.3 (33,2 30)	2.3 (33,23 0)	11 ~ 13(79 ~ 94,107 ~ 127)
	205/55R16	6.5Jx16	91	615	H	210	2.3 (33,2 30)	2.3 (33,2 30)	2.3 (33,2 30)	2.3 (33,23 0)	
	225/45R17	7.0Jx17	91	615	W	270	2.3 (33,2 30)	2.3 (33,2 30)	2.3 (33,2 30)	2.3 (33,23 0)	
Compact spare tyre	T125/80D15	4.0T×15	95	690	M	130	4.2 (60, 420)				
	T125/80D16	4.0T×16	97	730	M	130					

*1 : Load Index

*2 : Speed Symbol

* NOTICE

- We recommend that when replacing tyres, use the same originally supplied with the vehicles.
If not, that affects driving performance.
- When driving in high altitude grades, it is natural for the atmospheric pressure to decrease.
Therefore, please check the tyre pressure and add more air when necessary.
Additionally required tyre air pressure per km above sea level: 1.5psi/km

⚠ CAUTION

When replacing tyres, use the same size originally supplied with the vehicle.
Using tyres of a different size can damage the related parts or make it work irregularly.

For Australia and New Zealand

Item	Tyre size	Wheel size	Load Capacity		Speed capacity		Inflation pressure [bar(psi, kPa)]				Wheel lugnut torque Kgf·m (lbf·ft, N·m)
			Ll ^{*1}	Kg	SS ^{*2}	Km/h	Normal load		Maximum load		
							Front	Rear	Front	Rear	
Full size tyre	195/65R15	6.0Jx15	91	615	H	210	2.3 (33,2 30)	2.3 (33,2 30)	2.3 (33,2 30)	2.3 (33,23 0)	11 ~ 13(79 ~ 94,107 ~ 127)
	205/55R16	6.5Jx16	91	615	H	210	2.3 (33,2 30)	2.3 (33,2 30)	2.3 (33,2 30)	2.3 (33,23 0)	
	225/45R17	7.0Jx17	91	615	W	270	2.3 (33,2 30)	2.3 (33,2 30)	2.3 (33,2 30)	2.3 (33,23 0)	
	225/40R18	7.5Jx18	92	630	Y	300	2.4(3 5,240)	2.4(3 5,240)	2.4(3 5,240)	2.4(3 5,240)	
Compact spare tyre	T125/80D15	4.0T×15	95	690	M	130	4.2 (60, 420)				
	T125/80D16	4.0T×16	97	730	M	130					

*1 : Load Index

*2 : Speed Symbol

*** NOTICE**

- We recommend that when replacing tyres, use the same originally supplied with the vehicles.
If not, that affects driving performance.
- When driving in high altitude grades, it is natural for the atmospheric pressure to decrease.
Therefore, please check the tyre pressure and add more air when necessary.
Additionally required tyre air pressure per km above sea level: 1.5psi/km

▲ CAUTION

When replacing tyres, use the same size originally supplied with the vehicle. Using tyres of a different size can damage the related parts or make it work irregularly.

Recommended lubricants and capacities

To help achieve proper engine and powertrain performance and durability, use only lubricants of the proper quality.

The correct lubricants also help promote engine efficiency that results in improved fuel economy.

These lubricants and fluids are recommended for use in your vehicle.

Lubricant		Volume	Classification
Engine oil ¹ (drain and refill) Kia  TotalEnergies	(Petrol) 1.6 MPI	3.6 L (3.8 US qt.)	SAE 5W-30, ACEA A5/B5 ² SAE 5W-20, API Latest(ILSAC Latest) ³
	(Petrol) 2.0 MPI	4.0 L (4.2 US qt.)	SAE 5W-20, API Latest (ILSAC Latest) ⁴ SAE 5W-30, API Latest (ILSAC Latest) or ACEA A5/B5 ²
	(Petrol) 1.6 T-GDi	4.0 L (4.2 US qt.)	SAE 5W-30, ACEA A5/B5 ⁴
	Smartstream G1.6	3.8 L (4.01 US qt.)	SAE 0W-20, API SN PLUS/SP or ILSAC GF-6
Manual transmission fluid	(Petrol) 1.6 MPI	1.5 ~ 1.6 L (1.58 ~ 1.69 US qt.)	API GL-4, SAE 70W- SK : HK SYN MTF 70W- H.K.SHELL:SPIRAX S6 GHME
	(Petrol) 2.0 MPI	1.7 ~ 1.8 L (1.79 ~ 1.9 US qt.)	70W MTF- GS CALTEX: GS MTF HD 70W
Automatic transmission fluid	(Petrol) 1.6 MPI	6.7 L (7.1 US qt.)	SK ATF SP4M-1, MICHANG ATF SP4M-1, S-OIL ATF SP4M-1, Kia Genuine ATF SP4M-1
	(Petrol) 2.0 MPI		
Dual clutch transmission fluid	(Petrol) 1.6 T-GDi	1.9~2.0 L (2.01~2.11 US qt.)	Kia genuine DCTF 70W SYN-THETIC PLUS HK D DCTF TGO-10 PLUS (SK), SPIRAX S6 GHDE 70W DCTF PLUS (H.K.SHELL)

Lubricant		Volume	Classification	
Intelligent Variable Transmission (IVT) fluid	(Petrol) 2.0 MPI	6.7 L (7.1 US qt.)	SP-CVT*5 <div style="border: 1px solid black; padding: 5px; margin-top: 10px;"> <p>WARNING</p> <ul style="list-style-type: none"> - Do not change oil. - In case of repair, use only Genuine SP-CVT1 - Ne changez pas l'huile. - En cas de réparation,utilisez uniquement SP-CVT1 - 请勿随便更换油。 - 需要维修的情况下，只能使用正品 SP-CVT1 - Масло не заменять. В случае ремонта следует использовать только оригинальное SP-CVT1 </div>	
	Smartstream G1.6			
Coolant	(Petrol) 1.6 MPI	M/T	5.5 L (5.8 US qt.)	An Phosphate based ethylene glycol based coolant
		A/T	5.3 L (5.6 US qt.)	
	(Petrol) 2.0 MPI	M/T	5.6 L (5.9 US qt.)	
		A/T	5.4 L 5.7 US qt.)	
	(Petrol) 1.6 T-GDi	M/T	6.9 L (7.3 US qt.)	
		DCT	6.9 L (7.3 US qt.)	
	Smart-stream G1.6	IVT	6.6 L (6.97 US qt.)	
	Brake / clutch fluid *6		0.7~0.8 L (0.7 ~ 0.8 US qt.)	
Fuel		50 L (13.2 US gal.)	-	

- *1. Refer to "Recommended SAE viscosity number" on page 9-12.
- *2. For Middle East, India, Libya, Algeria, Morocco, Tunisia, Sudan, Egypt, Iran etc.
- *3. Except Middle East, India, Libya, Algeria, Morocco, Tunisia, Sudan, Egypt, Iran etc.
- *4. For Europe, CENTRAL&SOUTH AMERICA.
- *5. Use only specified genuine intelligent variable transmission fluid. The use of non-specified fluid (even marked as compatible with genuine) could result in shift quality deterioration and vibrations, eventually, the transmission failure.
- *6. To maintain your vehicle`s best brake and ABS/ESC performance, use Kia genuine brake fluid or those of an equivalent standard brake fluid as in the specification.

Recommended SAE viscosity number

⚠ CAUTION

Always be sure to clean the area around any filler plug, drain plug, or dipstick before checking or draining any lubricant. This is especially important in dusty or sandy areas and when the vehicle is used on unpaved roads. Cleaning the plug and dipstick areas will prevent dirt and grit from entering the engine and other mechanisms that could be damaged.

Engine oil viscosity (thickness) has an effect on fuel economy and cold

weather operating (engine start and engine oil flowability). Lower viscosity engine oils can provide better fuel economy and cold weather performance, however, higher viscosity engine oils are required for satisfactory lubrication in hot weather.

Using oils of any viscosity other than those recommended could result in engine damage.

When choosing an oil, consider the range of temperature your vehicle will be operated in before the next oil change. Proceed to select the recommended oil viscosity from the chart.

Temperature Range for SAE Viscosity Numbers										
Temperature	°C	-30	-20	-10	0	10	20	30	40	50
	(°F)	-10	0	20	40	60	80	100	120	
(Petrol) 1.6 MPI ¹						5W-40				
(Petrol) 1.6 T-GDi ²						5W-30, 5W-40				
(Petrol) 2.0 MPI						5W-20, 5W-30				
Smartstream G1.6						0W-20				

- *1. For better fuel economy, it is recommended to use the engine oil of a viscosity grade 5W-20 (except Middle East - API SN Plus or ILSAC GF-5) or 5W-30 (for Middle East - ACEA A5). However, if the engine oil is not available in your country, select the proper engine oil using the engine oil viscosity chart.
- *2. For better fuel economy, it is recommended to use the engine oil of a viscosity grade 5W-30 (ACEA A5). However, if the engine oil is not available in your country, select the proper engine oil using the engine oil viscosity chart.



An engine oil displaying this American Petroleum Institute (API) Certification Mark conforms to the International Lubricant Specification Advisory Committee (ILSAC). It is recommended to only use engine oils that uphold this API Certification Mark.

Vehicle identification number (VIN)

The vehicle identification number (VIN) is the number used in registering your vehicle and in all legal matters pertaining to its ownership, etc.

Frame number

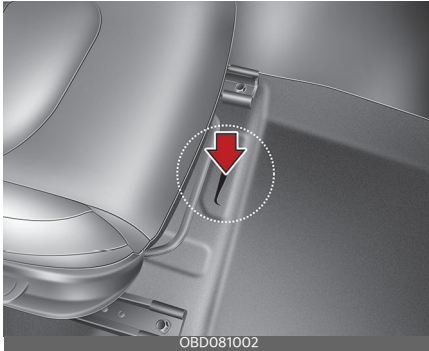

The number is punched on the floor under the driver or passenger seat. To check the number, open the cover.

The VIN is also on a plate attached to the top of the dashboard. The number on the plate can easily be seen through the windscreen from outside.

Type A



Type B



Vehicle certification label (if equipped)

Type A

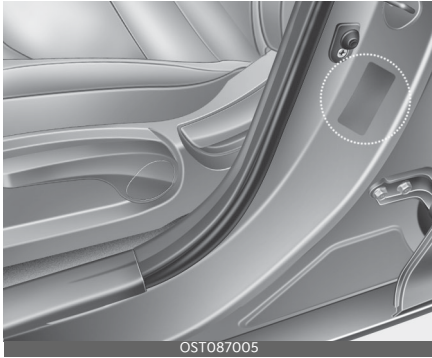

Type B

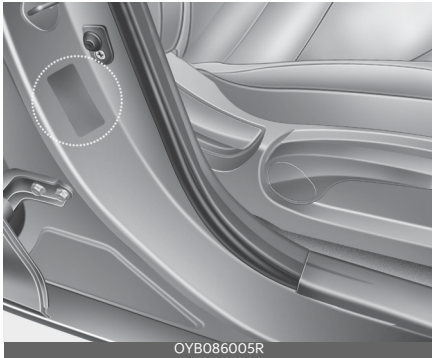

The vehicle certification label attached on the driver's (or front passenger's) side centre pillar gives the vehicle identification number (VIN).

Tyre specification and pressure label

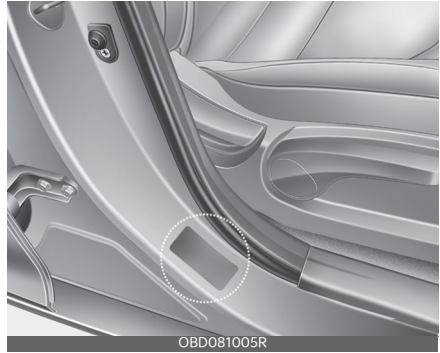

The tyres supplied on your new vehicle are chosen to provide the best performance for normal driving.

The tyre label located on the driver's side centre pillar gives the tyre pressures recommended for your vehicle.

Engine number

(Petrol) 1.6 MPI

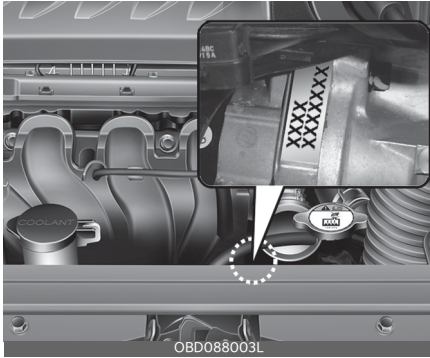

(Petrol) 2.0 MPI

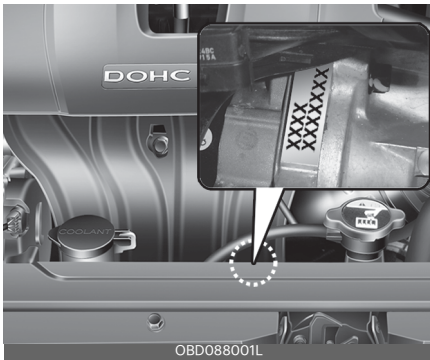

(Petrol) 1.6 T-GDi

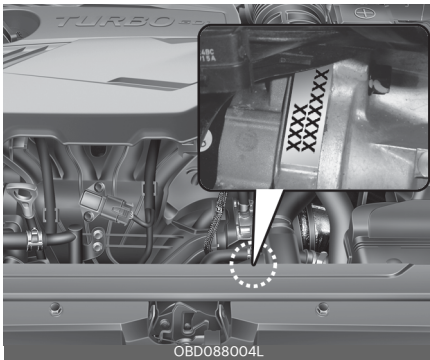

Smartstream G1.6

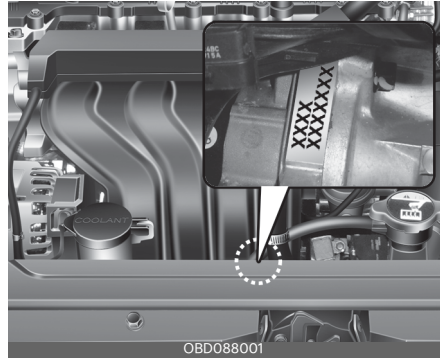

The engine number is stamped on the engine block as shown in the drawing.

Air conditioner compressor label

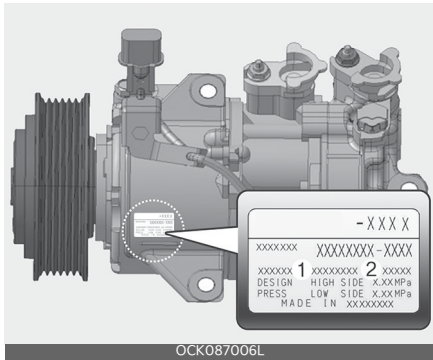

A compressor label informs you the type of compressor your vehicle is equipped with such as model, supplier part number, production number, refrigerant (1) and refrigerant oil (2).

Refrigerant label



The refrigerant label is located on the underside of the bonnet.

Declaration of conformity

Example



The radio frequency components of the vehicle comply with requirements and other relevant provisions of Directive 1995/5/EC.

Further information including the manufacturer's declaration of conformity is available on Kia web site as follows; <http://www.kia-hotline.com>

FUEL LABEL (if equipped)

Petrol engine

For Europe

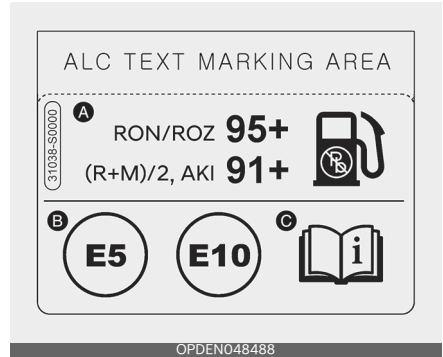

Except Europe

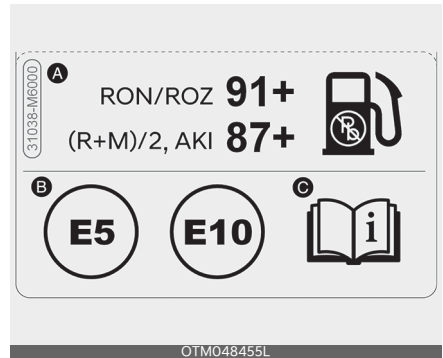

The fuel label is attached on the fuel filler door.

A. Octane rating of unleaded Petrol (Petrol)

1. RON/ROZ: Research Octane Number

2. (R+M)/2, AKI: Anti Knock Index

B. Identifiers for Petrol-type fuels

* This symbol means usable fuel. Do not use any other fuel.

C. For further details, refer to "Fuel requirements" on page 1-2.

Abbreviation **A**

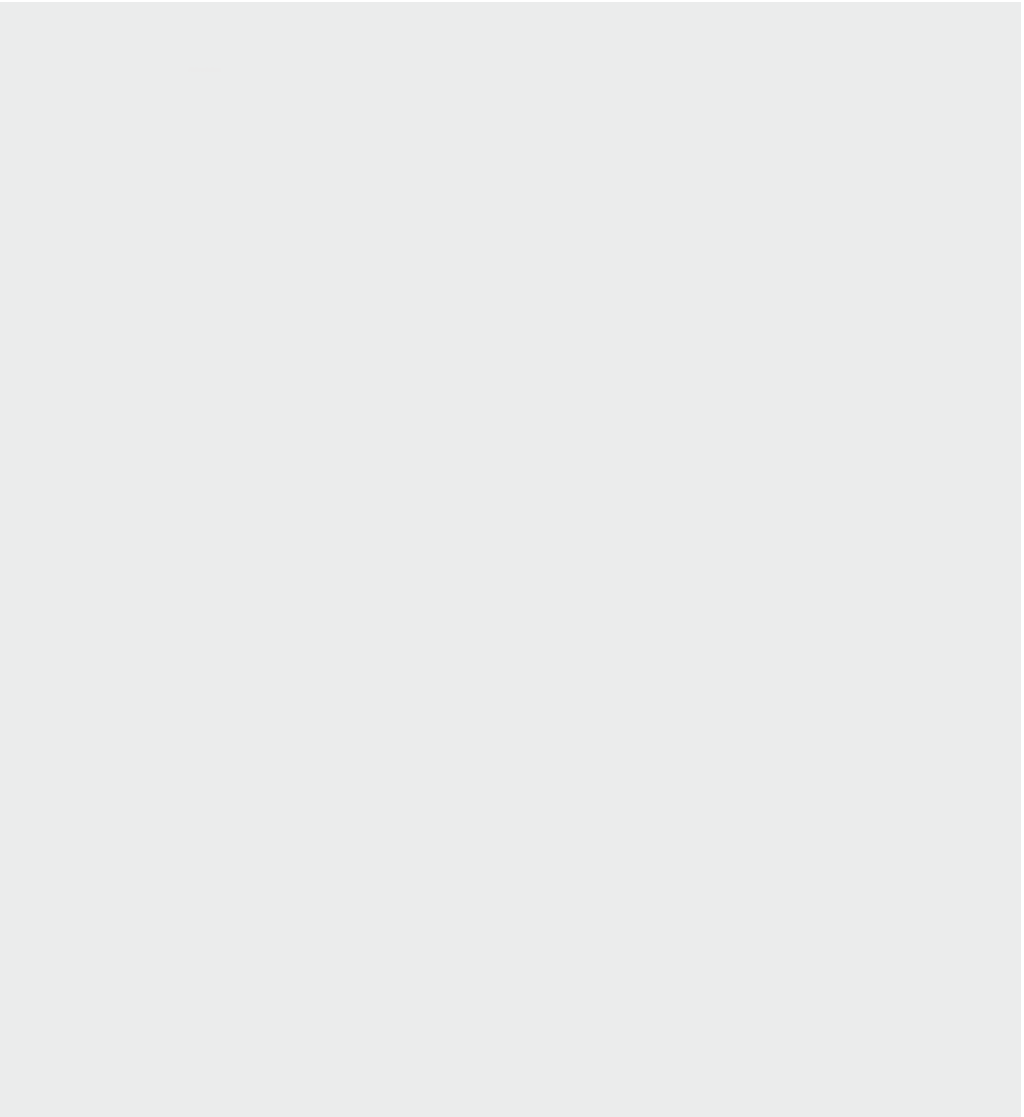

Abbreviation

ABS

Anti-lock Brake System

BCA

Blind-Spot Collision-Avoidance Assist

BCW

Blind-Spot Collision Warning

BVM

Blind-Spot View Monitor

CC

Cruise Control

CRS

Child Restraint System

DAW

Driver Attention Warning

DRL

Daytime Running Light

EBD

Electronic Brake force Distribution

ECM

Electric Chromic Mirror

ESC

Electronic Stability Control

ESS

Emergency Stop Signal

FCA

Forward Collision-Avoidance Assist

HAC

Hill-start Assist Control

HBA

High Beam Assist

HMSL

High Mounted Stop Lamp

HUD

Head-Up Display

LATCH

Lower Anchors and Tether for Children

LFA

Lane Following Assist

LKA

Lane Keeping Assist

MDPS

Motor Driven Power Steering

MIL

Malfunction Indicator Lamp

MSLA

Manual Speed Limit Assist

ODS

Occupant Detection System

PCA-R

Reverse Parking Collision-Avoidance Assist

PDW

Reverse Parking Distance Warning

RCCA

Rear Cross-Traffic Collision-Avoidance Assist

RCCW

Rear Cross-Traffic Collision Warning

Abbreviation

RVM

Rear View Monitor

SCC

Smart Cruise Control

SRS

Supplemental Restraint System

SRSCM

SRS Control Module

SVM

Surround View Monitor

TBT

Turn By Turn

TCS

Traction Control System

TIN

Tyre Identification Number

TPMS

Tyre Pressure Monitoring System

VIN

Vehicle Identification Number

VSM

Vehicle Stability Management

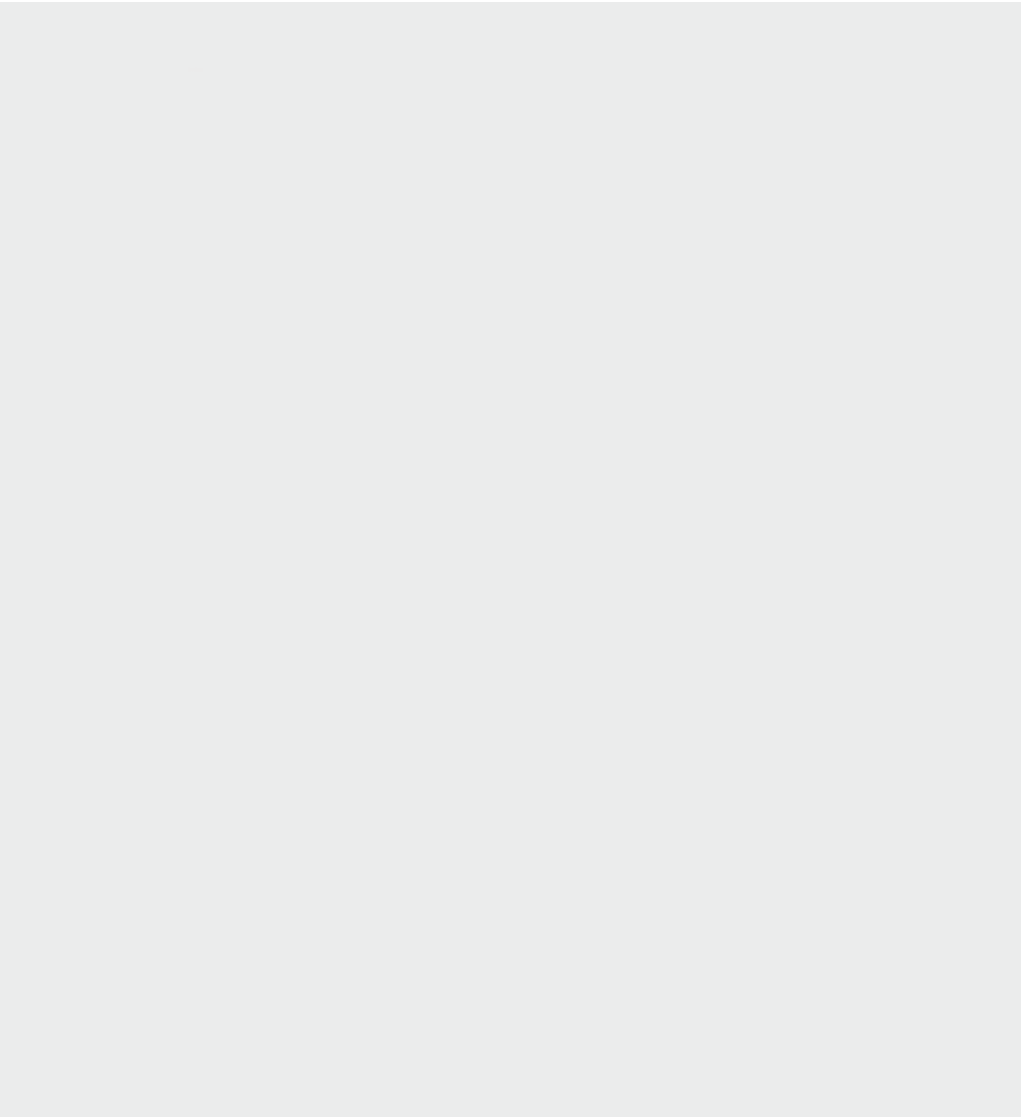

Index

A

activate upon washer fluid use	4-136
air bag - supplemental restraint system	3-40
air bag collision sensors	3-55
air bag warning label	3-61
air bag warning light	3-43
curtain air bag	3-53
driver's and passenger's front air bag	3-47
how does the air bag system operate	3-41
side air bag	3-51
SRS components and functions	3-45
air bag collision sensors	3-55
air bag warning label	3-61
air bag warning light	3-43
air cleaner	8-47
filter replacement	8-47
air conditioner compressor label	9-16
air conditioning refrigerant label	4-118
air conditioning system	9-6
air ventilation seat	4-144
appearance care	8-103
exterior care	8-103
interior care	8-107
audio system	5-3
radio	5-4
USB port	5-4
auto defogging system	4-134
automatic air ventilation	4-135
automatic climate control system	4-126
heating and air conditioning automatically	4-127
heating and air conditioning manually	4-128
temperature conversion (°C ↔ °F)	4-131
automatic transmission	6-19
automatic transmission operation	6-19
paddle shifter	6-21
shift lock system	6-22
shift-lock override	6-22

transmission ranges

6-20

B

battery	8-52
for best battery service	8-52
blind-spot collision warning (BCW)	6-86
detecting sensor	6-87
malfunction and limitations	6-90
operation	6-89
settings	6-88
blind-spot collision-avoidance assist (BCA)	6-94
detecting sensor	6-95
malfunction and limitations	6-101
operation	6-98
settings	6-96
bonnet	4-37
closing	4-38
opening	4-37
brake system	6-38
applying auto hold function	6-44
applying the parking brake	6-40, 6-41
auto hold	6-44
canceling auto hold function	6-45
electronic parking brake (EPB)	6-41
electronic stability control (ESC)	6-49
Emergency Stop Signal (ESS)	6-53
ESC operation	6-50
hill-start assist control (HAC)	6-51
malfunction of EPB	6-44
parking brake (hand-type)	6-40
power brakes	6-38
releasing the parking brake	6-40, 6-42
vehicle stability management (VSM)	6-52
VSM operation	6-52
brake/clutch fluid	8-45
checking the brake/clutch fluid level	8-45
bulb replacement (interior)	
glove box lamp (bulb type) replacement	8-97
map lamp (bulb type) bulb replacement	8-95
map lamp (LED type) bulb replacement	8-95
room lamp (bulb type) bulb replacement	8-95

room lamp (LED type) bulb replacement	8-96
trunk/tailgate room lamp (bulb type) bulb replacement	8-97
vanity mirror lamp (bulb type) bulb replacement	8-96
bulb wattage	9-7

C

child restraint system (CRS)	3-28
installing a child restraint system (CRS)	3-30
ISOFIX anchorage and toptether anchorage (ISOFIX anchorage system) for children	3-31
our recommendation-Children always in the rear	3-28
recommended child restraint systems - for europe	3-39
securing a child restraint system with a lap/shoulder belt	3-34
selecting a child restraint system (CRS)	3-29
Suitability of each seating position for belted & ISOFIX child restraint systems according to UN regulations(for europe)	3-36
suitability of each seating position for belted & ISOFIX child restraint systems according to UN regulations(except europe)	3-37
child-protector rear door lock	4-19
climate control air filter	8-49
filter inspection	8-49
cruise control (CC)	6-114
operation	6-114
curtain air bag	3-53

D

declaration of conformity	6-150, 9-17
dimensions	9-2
door locks	4-15
with central door lock/unlock switch	4-18
with the door handle	4-17
with the mechanical key	4-16
with the smart Key	4-15

drive mode integrated control system	6-54
drive mode	6-54
driver attention warning (DAW)	6-107
basic function	6-107
detecting sensor	6-107
leading vehicle departure alert	6-107
malfunction and limitations	6-111
settings	6-108
driver's and passenger's front air bag	3-47
driver's seat belt warning	3-17
dual clutch transmission (DCT)	6-25
DCT warning messages	6-26
dual clutch transmission operation	6-25
paddle shifter	6-29
shift lock system	6-30
shift-lock override	6-30
transmission ranges	6-28

E

easy access function	3-9
economical operation	6-163
emergency commodity	7-22
emergency starting	7-4
jump starting	7-4
push-starting	7-5
emission control system	8-109
engine compartment	8-5
engine coolant	8-41
changing the coolant	8-44
checking the coolant level	8-41
engine coolant temperature gauge	4-55
engine number	9-15
engine oil	8-38
changing the engine oil and filter	8-40
checking the engine oil level	8-38
engine spec	9-4
ENGINE START/STOP button	6-11
ENGINE START/STOP button position	6-11
starting the engine	6-14
stopping the petrol engine	6-16

F

forward collision-avoidance assist (FCA) (front view camera only)	6-57
basic function	6-57
detecting sensor	6-57
malfunction and limitations	6-62
operation	6-60
settings	6-58
forward collision-avoidance assist (FCA) (sensor fusion)	6-69
basic function	6-69
detecting sensor	6-69
malfunction and limitations	6-74
operation	6-72
settings	6-70
forward/reverse parking distance warning (PDW)	4-96
detecting sensors	4-96
malfunction and limitations	4-98
operation	4-97
settings	4-96
front passenger's seat belt warning	3-17
fuel filler door	4-39
closing	4-40
opening	4-39
fuel gauge	4-56
fuel label	9-17
fuses	8-63
driver's side fuse panel	8-69
engine compartment fuse panel	8-73
engine compartment fuse panel (battery terminal cover)	8-74
fuse/relay panel description	8-68
inner panel fuse replacement	8-65

G

gauges	4-54
gross vehicle weight	9-5

H

heated steering wheel	4-47
high beam assist (HBA)	4-107

I

if the engine overheats	7-6
if the engine will not start	7-3
if you have a flat tyre (with spare tyre)	7-10
changing tyres	7-11
important - use of compact spare tyre	7-14
jack and tools	7-10
jack label	7-16
removing and storing the spare tyre	7-11
immobiliser system	4-14
in case of an emergency whilst driving	7-2
infotainment system	5-3
audio system	5-3
audio (without touch screen)	5-7
inside rear view mirror	4-48
instrument cluster	4-52
gauges	4-54
instrument cluster control	4-53
LCD display control	4-53
transmission shift indicator	4-59
intelligent variable transmission (IVT)	6-32
intelligent variable transmission (IVT) operation	6-32
IVT warning messages	6-33
shift lock system	6-36
shift-lock override	6-36
transmission ranges	6-34
interior features	4-140
ashtray	4-140
cigarette lighter	4-140
coat hook	4-148
cup holder	4-141
luggage net holder	4-149
power outlet	4-146
sliding armrest	4-142
interior light	4-113
glove box lamp	4-115
map lamp	4-113
room lamp	4-114
trunk/tailgate room lamp	4-114
vanity mirror lamp	4-115

K

key positions	6-8
ignition switch position	6-8
starting the engine	6-9
stopping the engine	6-11
keys	4-6
battery replacement	4-6
mechanical Key	4-8
remote key	4-7
smart key	4-9

L

lane following assist (LFA)	6-131
detecting sensor	6-131
operation	6-132
settings	6-131
lane keeping assist (LKA)	6-81
detecting sensor	6-81
malfunction and limitations	6-84
operation	6-82
settings	6-81
LCD display	4-62
LCD display modes	4-62
master warning mode	4-64
trip computer mode	4-63
turn by turn mode	4-63
warning messages	4-69
LCD display control	4-53
light bulb position (front)	8-80
front fog lamp (LED type) bulb replacement	8-86
front turn signal lamp (bulb type) bulb replacement - headlamp type A	8-85
headlamp and front fog lamp aiming (for europe)	8-98
headlamp (high/low) (bulb type) bulb replacement - headlamp type A	8-84
headlamp (LED type) bulb replacement - headlamp type B	8-86
position lamp/daytime running lamp (LED type) bulb replacement - headlamp type A	8-85
light bulb position (rear)	8-81
back up lamp (bulb type) bulb replacement	8-93
high mounted stop lamp bulb replacement	8-94

high mounted stop lamp (bulb type) bulb replacement	8-94
license plate lamp (bulb type) bulb replacement	8-93
rear fog lamp (bulb type) bulb replacement - 4door type B	8-90
rear fog lamp (bulb type) bulb replacement -5door	8-91
rear fog lamp (LED type) bulb replacement - 4door type D	8-92
rear turn signal lamp (bulb type) bulb replacement	8-92
stop and tail lamp (LED type) bulb replacement	8-91
stop/tail lamp (bulb type) bulb replacement - 4 door type A, B	8-87
stop/tail lamp (bulb type) bulb replacement - 5 door type A	8-88
tail lamp (inside) (bulb type) bulb replacement - 4door type A, B	8-89
tail lamp (inside) (bulb type) bulb replacement - 5 door type A	8-89
light bulb position (side)	8-83
side repeater lamp (bulb type) bulb replacement	8-87
side repeater lamp (LED type) bulb replacement	8-86
light bulbs	8-79
bulb replacement precaution	8-79
lighting	4-100
battery saver function	4-100
daytime running light (DRL)	4-101
fog light	4-105
headlamp delay function	4-100
headlamp welcome function	4-101
headlight levelling device	4-109
high beam assist (HBA)	4-107
lighting control	4-101
operating turn signals and lane change signals	4-105
lighting control	
head light (low beam)	4-102
luggage volume	9-6

M

manual climate control system	4-120
--------------------------------------	-------

heating and air conditioning	4-121
manual speed limit assist (MSLA)	6-105
manual transmission	6-16
good driving practices	6-18
manual transmission operation	6-16
using the clutch	6-17
mirror - inside rear view	
day/night rear view mirror	4-49
electric chromic mirror (ECM)	4-49
mirror - outside rear view	
adjusting	4-50
folding	4-51

O

outside rear view mirror	4-49
---------------------------------	------

P

parking brake (hand type)	8-47
checking the parking brake	8-47
passenger's front air bag ON/OFF switch	3-49
power window lock button	4-35

R

rear cross-traffic collision warning (RCCW)	6-134
detecting sensor	6-134
malfunction and limitations	6-137
settings	6-135
rear cross-traffic collision-avoidance assist (RCCA)	6-141
detecting sensor	6-141
malfunction and limitations	6-146
operation	6-143
settings	6-141
rear occupant alert (ROA) system	4-19
rear passenger's seat belt warning	3-18
rear view monitor (RVM)	4-89
detecting sensor	4-89
malfunction and limitations	4-92
rear view	4-91

recirculation mode plus	4-136
recommended lubricants and capacities	9-10
recommended SAE viscosity number	9-12
refrigerant label	9-16
remote key	4-7
remote window closing/opening system	4-35
reverse parking distance warning (PDW)	4-93
detecting sensor	4-93
malfunction and precautions	4-95
operation	4-94
settings	4-94
road warning	7-2
hazard warning flasher	7-2

S

safe exit warning (SEW)	4-20
detecting sensor	4-20
malfunction and limitations	4-23
operation	4-22
settings	4-21
scheduled maintenance service	8-10
severe driving conditions	8-15, 8-34
seat belts	3-16
care of seat belts	3-27
pre-tensioner seat belt	3-23
seat belt precautions	3-25
seat belt restraint system	3-16
seat warmer	4-142
seatback pocket	3-12
seats	3-3
driver position memory system (for power seat)	3-8
front seat adjustment - manual	3-6
front seat adjustment - power	3-7
headrest (for front seat)	3-9
rear seat adjustment	3-12
seatback pocket	3-12
side air bag	3-51
smart cruise control (SCC)	6-117
detecting sensor	6-117
malfunction and limitations	6-126
operating	6-120
settings	6-117

smart key	4-9	trunk(for 4door)	4-25
smart trunk(for 4door)	4-27	closing	4-25
detecting area	4-29	emergency trunk safety release	4-26
how to deactivate the smart trunk function	4-28	opening	4-25
how to use the smart trunk	4-27	tyre pressure monitoring system (TPMS)	7-7
special driving conditions	6-165	indication of low tyre pressure	7-8
driving at night	6-166	system overview	7-7
driving in flooded areas	6-167	TPMS setting	7-7
driving in the rain	6-166	tyre pressure monitoring system malfunction	7-9
driving off-road	6-167	tyre specification and pressure label	9-14
hazardous driving conditions	6-165		
highway driving	6-167	tyres and wheels	8-55, 9-8
rocking the vehicle	6-165	for australia and new zealand	9-9
smooth cornering	6-166	for europe	9-8
steering wheel	4-45	tyre maintenance	8-59
heated steering wheel	4-47	tyre replacement	8-58
horn	4-47	tyre rotation	8-57
motor driven power steering (MDPS)	4-45	tyre sidewall labeling	8-60
tilt & telescopic steering wheel	4-46	tyre traction	8-59
storage compartment	4-139		
centre console storage	4-139		
glove box	4-139		
sunglass holder	4-139		
sun visor	4-144	U	
sunroof	4-41	USB charger	4-145
automatic reversal	4-43	user settings mode	4-64
resetting	4-44		
slide open/close	4-43		
sunshade	4-42	V	
tilt open/close	4-42	vehicle certification label	9-14
sunroof inside air recirculation	4-135	vehicle identification number (VIN)	9-13
		vehicle weight	6-180
T		W	
tailgate(for 5door)	4-30	warning and indicator lights	4-79
closing	4-30	indicator lights	4-86
emergency tailgate safety release	4-31	warning lights	4-79
opening	4-30	washer fluid	8-46
theft-alarm system	4-12	checking the washer fluid level	8-46
towing	7-18	windows	4-32
emergency towing	7-19	automatic reversal	4-34
removable towing hook	7-18	opening and closing	4-33
towing service	7-18	power window lock button	4-35
trip computer	4-74	remote window closing/opening system	4-35
trip information (for type A cluster)	4-74	to reset the power windows	4-34
trip information (trip computer) (for type B cluster)	4-76		

windscreen defrosting and defogging	4-133
auto defogging system	4-134
defogging inside windscreen with automatic climate control	4-134
defogging inside windscreen with manual climate control system	4-133
defogging logic	4-137
defroster	4-137
defrosting outside windscreen with automatic climate control	4-134
defrosting outside windscreen with manual climate control system	4-133
winter driving	6-168
wiper blades	8-50
blade inspection	8-50
blade replacement	8-50
wipers and washers	4-110
wireless smart phone charging system	4-146